



IFM-GEOMAR

Leibniz-Institut für Meereswissenschaften
an der Universität Kiel

RRS JAMES COOK
Fahrtbericht / Cruise Report JC23-A & B

CHILE-MARGIN-SURVEY
OFEG Barter Cruise with SFB 574

03.03.-25.03. 2008 Valparaiso - Valparaiso
26.03.-18.04.2008 Valparaiso - Valparaiso

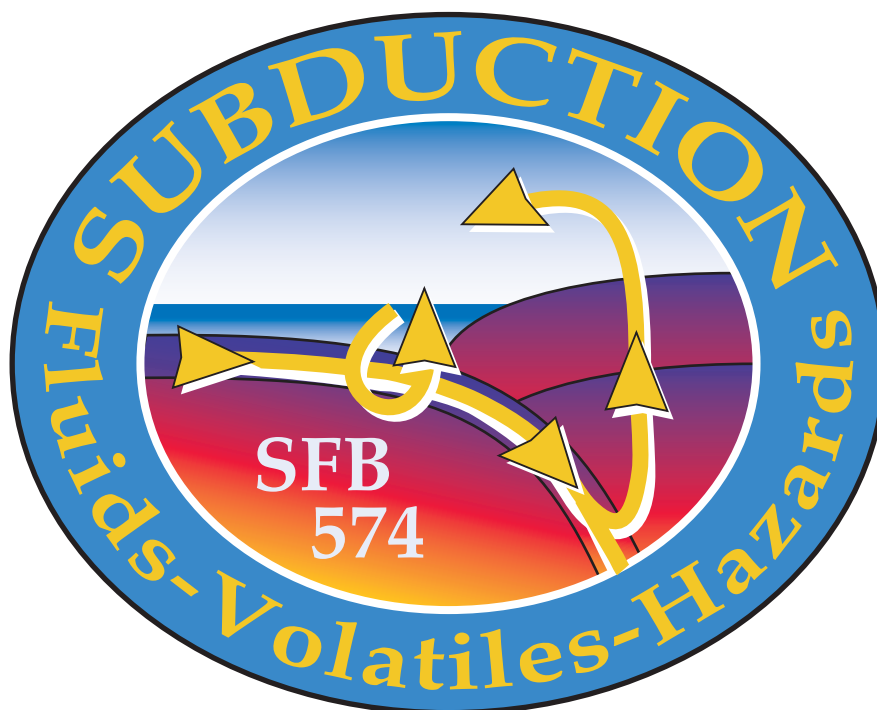

Berichte aus dem Leibniz-Institut
für Meereswissenschaften an der
Christian-Albrechts-Universität zu Kiel

Nr. 20
August 2008



IFM-GEOMAR

Leibniz-Institut für Meereswissenschaften
an der Universität Kiel

RRS JAMES COOK Fahrtbericht / Cruise Report JC23-A & B

CHILE-MARGIN-SURVEY OFEG Barter Cruise with SFB 574

03.03.-25.03.2008 Valparaiso - Valparaiso

26.03.-18.04.2008 Valparaiso - Valparaiso

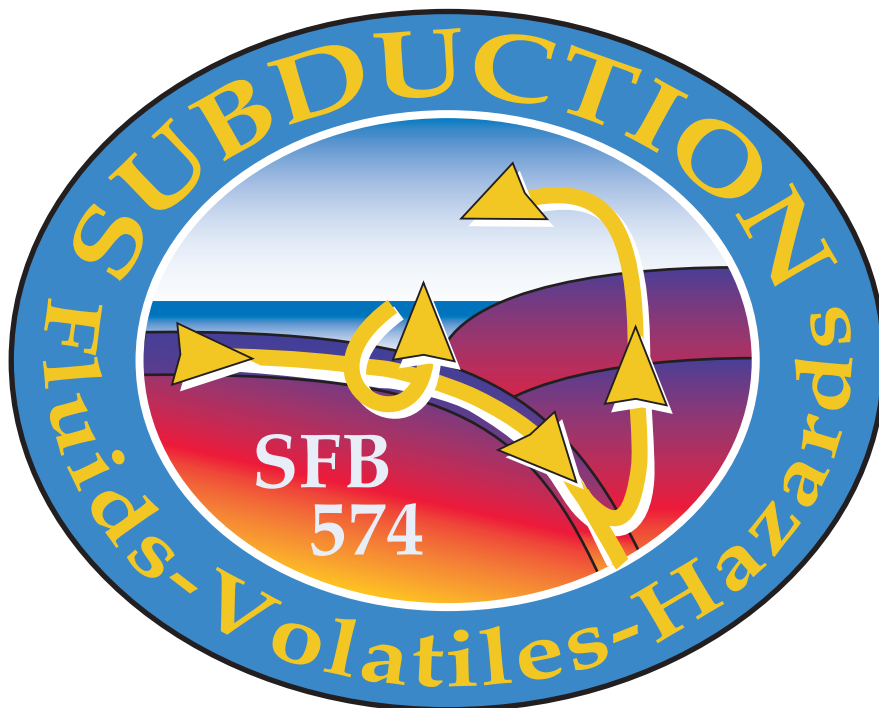

Berichte aus dem Leibniz-Institut
für Meereswissenschaften an der
Christian-Albrechts-Universität zu Kiel

Nr. 20, August 2008

ISSN Nr.: 1614-6298



IFM-GEOMAR

Leibniz-Institut für Meereswissenschaften
an der Universität Kiel

Das Leibniz-Institut für Meereswissenschaften
ist ein Institut der Wissenschaftsgemeinschaft
Gottfried Wilhelm Leibniz (WGL)

The Leibniz-Institute of Marine Sciences is a
member of the Leibniz Association
(Wissenschaftsgemeinschaft Gottfried
Wilhelm Leibniz).

Herausgeber / Editor:
Ernst Flüh & Jörg Bialas

IFM-GEOMAR Report
ISSN Nr.: 1614-6298

Leibniz-Institut für Meereswissenschaften / Leibniz Institute of Marine Sciences

IFM-GEOMAR
Dienstgebäude Westufer / West Shore Building
Düsternbrooker Weg 20
D-24105 Kiel
Germany

Leibniz-Institut für Meereswissenschaften / Leibniz Institute of Marine Sciences

IFM-GEOMAR
Dienstgebäude Ostufer / East Shore Building
Wischhofstr. 1-3
D-24148 Kiel
Germany

Tel.: ++49 431 600-0
Fax: ++49 431 600-2805
www.ifm-geomar.de

TABLE OF CONTENTS

	Page
1. 1. SUMMARY	1
1. 2. ZUSAMMENFASSUNG	2
1. 3. RESUMEN	3
2. AIMS OF THE CRUISE JC23	4
3. PARTICIPANTS	9
3.1. Scientists JC 23	9
3.2. Crew JC 23	10
3.3. Addresses of Participating Institutions	11
4. AGENDA	14
5. SEISMIC INVESTIGATIONS	18
5.1. Seismic Instrumentation	18
5.1.1. OBH/OBS	18
5.1.2. Airgun Systems	19
5.1.3. Seismic Data Processing	22
5.2. Seismic Profiles	35
5.2.1. P01 and 11	35
5.2.2. P02 and 22	38
5.2.3. P03 and 33	41
5.2.4. P04	41
5.2.5. P08 and 81	46
5.2.6. P09	47
5.2.7. P10	55
5.2.8. P11	64
5.2.9. P12	74
5.3. Seismic Network	87
5.4. Sub Bottom Profiler	89
6. MAGNETICS	103
7. GRAVITY	106

8.	MULTIBEAM BATHYMETRY	107
8.1.	Kongsberg multibeam bathymetry systems on RRS JAMES COOK	107
8.2.	Work done and preliminary results	111
8.2.1.	Water sound velocity profile	111
8.2.2.	Multibeam bathymetry survey results	112
9.	MAGNETOTELLURIC INSTRUMENTATION	139
10.	SIDECAN SONAR OPERATIONS	143
11.	CORING	154
12.	METHAN SENSORS	155
13.	ACKNOWLEDGEMENTS	162
14.	REFERENCES	163
15.	APPENDICES	165
15.1.	Ocean Bottom Instrumentation	165
15.2.	Airgunshots	172
15.2.1.	Airgunshots P01	172
15.2.2.	Airgunshots P02	174
15.2.3.	Airgunshots P03	175
15.2.4.	Airgunshots P04	176
15.2.5.	Airgunshots P08-P09	177
15.2.6.	Airgunshots P10	178
15.2.7.	Airgunshots P11-P12-P13	179
15.3.	Gravity	180
15.4.	Scripts for processing of multibeam data	186
15.5.	Magnetotelluric Instrumentation	199
15.6.	Core descriptions	200
15.6.1.	Core positions	200
15.6.2.	Core protocol	201
15.7.	Marine Mammal Report JC23	206
15.8.	Timetable	207

1.1 Summary

Cruise JC23 is one of the first major cruises completed under the OFEG Barter agreement, during which the British National Oceanographic Centre (NOC) provided shiptime onboard RRS JAMES COOK. Seismic operations were supported by equipment and technical staff of the British National Marine Facilities group (NMF) in exchange with IFM-GEOMAR support during the British Barter cruise SO198 onboard the German RV SONNE.

Funds for mobilising the German research team were provided by the German Science Foundation (DFG) in conjunction with the Collaborative Research Centre 574 (SFB 574) of the University of Kiel. In the past seven years, the SFB 574 investigated the pathways and fluxes of volatiles through the erosive subduction zone off Central America. For comparison, the studies are now extended to the accretionary margin off Central Chile.

The first leg of the cruise JC23 was dedicated to seismic and seismological crustal studies. One of the aims was to observe seismicity on the outer rise of the Pacific Plate. We therefore deployed a short term seismological array comprising a total of 17 instruments. This network was accompanied with a long term network focussed on the seismogenic zone, which consists of 18 instruments and will be in operation for eight months and is extended onshore by 30 additional seismological stations. Active seismic wide-angle studies were carried out along three profiles perpendicular to the margin and one along strike across the outer rise. The main purpose of these studies is to investigate a possible serpentinisation of the oceanic plate due to penetration of seawater into fractures, which may open during the bending of the oceanic plate. Further more the profiles were extended onshore to image the structure of the continental margin and provide a good velocity field for the seismological investigations.

Leg 2 was dedicated to high-resolution acoustic studies. Bathymetry, sub-bottom profiler, high-resolution seismic and deep towed sidescan sonar surveys were undertaken in order to investigate structures of slope failure and to search for active seep sites. In addition, three gravity cores with hemipelagic sediment were taken from the oceanic plate where the wide angle profiles were collected as well as 10 cores from the two studied slump sites at the continental slope. A total core length of 34.6 m was retrieved from the headscarp, the olistolith, the debris cone and undisturbed reference sites of the two slumps as well as from the oceanic plate. The shallow landslide, named "Valdés" was found at the landward wall of a ridge like structure, which terminates a sedimentary basin towards the steepening side of the continental slope. The second landslide was found at 5000 m water depth. The debris of this slump, named Reloca, could be traced all the way across the sediment covered deep-sea trench. Two sidescan surveys were completed in order to search for active seeps. These were chosen according to the bathymetric survey, that indicated promising structures. Only the southern most survey at about 36°20' S succeeded in the discovery of three active seep locations. During the deep towed sidescan survey clear flares of various intensity were observed in the 70 kHz backscatter signal. The sites are located on the top of 600 m high scarp in about 1000 m water depth.

1.2 Zusammenfassung

Die James Cook Fahrt JC23 ist eine der ersten längeren Fahrten unter dem OFEG Barter Abkommen, bei dem das britische National Oceanographic Centre (NOC) Schiffszeit an Bord der RRS JAMES COOK bereitstellt. Die seismischen Arbeiten werden unterstützt durch Ausrüstung und technische Mitarbeiter der British National Marine Facilities Group (NMF), im Austausch mit Unterstützung seitens des IFM-GEOMAR während der britischen Barter Fahrt SO 198 auf dem deutschen Forschungsschiff RV SONNE.

Das Deutsche Wissenschaftsteam wird finanziert von der Deutschen Forschungsgemeinschaft (DFG) in Zusammenarbeit mit dem Sonderforschungsbereich 574 (SFB 574) der Universität Kiel. In den letzten sieben Jahren erforschte der SFB 574 die Wege und Flüsse von Volatilen an der erosiven Subduktionszone von Zentralamerika. Zum Vergleich wurden die Untersuchungen nun an dem akkretionären Rand vor Chile erweitert.

Der erste Abschnitt der JC 23 Fahrt stand im Zeichen von seismischen und seismologischen Krustenuntersuchungen. Ein Ziel war die Aufzeichnung der seismischen Aktivität auf dem Outer Rise der Pazifischen Platte. Dafür wurde ein Kurzzeit-Netz aus 17 seismologischen Stationen ausgelegt. Dieses Netz wurde mit einem Langzeit-Netz erweitert, welches sich auf die seismogene Zone konzentriert und aus 18 Stationen besteht. Dieses sollen insgesamt acht Monate in Betrieb sein und wird mit 30 seismischen Landstationen erweitert. Aktive weitwinkelseismische Untersuchungen wurden auf drei Profilen senkrecht zum Plattenrand und einem quer über dem Outer Rise durchgeführt. Die Hauptzielsetzung der Untersuchungen ist die Erforschung einer möglichen Serpentinisierung der ozeanischen Platte, infolge von eindringendem Meerwasser in Brüche, die sich bei der Umbiegung der ozeanischen Platte öffnen. Des Weiteren wurden die Profile an Land verlängert um die Struktur des Kontinentalrandes abzubilden und ein gutes Geschwindigkeitsmodell für seismologische Erkundungen zu erstellen.

Abschnitt zwei befasste sich mit hochauflösenden akustischen Untersuchungen. Bathymetrie, Sub Bottom Profiler, hochauflösende Seismik und das tiefgeschleppten Geoakustische System DTS wurden genutzt, um Rutschungsstrukturen und aktive Gasquellgebiete zu erkunden. Zusätzlich wurden drei Schwerelotkerne mit hemipelagischen Sedimenten der ozeanischen Platte gezogen, dort wo die weitwinkelseismischen Profile aufgenommen wurden. Ebenso 10 Kerne von zwei untersuchten Rutschungen am Kontinentalhang. Eine Gesamtkernlänge von 34,6m wurde an einer Abbruchkante, dem Olistolith, am Ablagerungsfächer und an ungestörten Referenzstellen der zwei Rutschungen sowie der ozeanischen Platte gewonnen. Die flache Rutschung 'Valdés' wurde an der landwärts gerichteten Seite einer rückenähnlichen Struktur gefunden, welche ein sedimentäres Becken von der steilen Seite des Kontinentalhanges abgrenzt. Die zweite Rutschung wurde in 5000m Wassertiefe entdeckt. Die Ablagerungen dieser Rutschung, 'Reloca', können bis über den Sedimentbedeckten Tiefseegraben nachgewiesen werden. Zwei Sidescan Messungen wurden durchgeführt, um aktive Gasaustritte zu finden. Die Gebiete wurden gemäß den bathymetrischen Untersuchungen ausgewählt, die viel versprechende Strukturen angedeutet haben. Nur in dem südlichsten Untersuchungsgebiet um 36°20'S waren wir erfolgreich mit dem Fund von drei Lokationen mit aktiven Gasaustritten. Während der tiefgeschleppten Sidescan Untersuchungen wurden deutliche Gas-Flares verschiedener Intensität auf dem 70kHz Rückstreuungssignal beobachtet. Die Stellen liegen auf den Spitzen einer 600m hohen Abbruchkante in über 1000m Wassertiefe.

1.3 Resumen

El crucero JC23 es uno de los primeros cruceros principales completados bajo el acuerdo de colaboración OFEG, en el que el Centro Nacional Oceanográfico Británico (NOC) proporcionó el shiptime abordo del RRS JAMES COOK. Los estudios sísmicos fueron realizados con equipos y personal técnico del Grupo Nacional Británico de Facilidades Marinas (NMF) en intercambio con el IFM-GEOMAR durante el crucero británico SO198 abordo del buque científico alemán RV SONNE.

Los fondos para movilizar el equipo de investigación alemán fueron proporcionados por la Fundación Alemana de Ciencias (DFG) junto con el Centro Cooperativo de Investigación 574 (SFB 574) de la Universidad de Kiel. En los últimos siete años el SFB investigó los senderos y flujos de volátiles a través de la zona de subducción erosiva frente a América Central. Con el objeto de comparar las previas investigaciones, los estudios ahora se han extendido al margen acrecionario del centro de Chile.

El primer tramo del crucero JG23 fue dedicado al estudio sísmico y sismológico de la corteza. Uno de los objetivos fue el estudio de sismicidad en el outer rise de la Placa de Nazca. Para ello se instaló una red sismológica de corto período con un total de 17 estaciones. Esta red fue acompañada con una red de largo período que se concentró en la zona seismogénica, la cual consiste en 18 instrumentos y estará en operación por ocho meses, extendiéndose tierra adentro con 30 estaciones sismológicas adicionales. Estudios de sísmica de refracción de gran ángulo se llevaron a cabo a lo largo de tres perfiles perpendiculares al margen y uno paralelo a la fosa atravesando el outer rise. El propósito principal de estos estudios es investigar procesos de posible serpentización de la placa oceánica debido a la penetración del agua marina dentro de fracturas, las cuales pueden ser generadas por la flexión de la placa oceánica. Además, los perfiles fueron extendidos tierra adentro con el objeto de crear una imagen sísmica del margen continental y proporcionar un campo de velocidades de alta resolución para las investigaciones sismológicas.

El segundo tramo fue dedicado a estudios acústicos de alta resolución, entre ellos batimetría, sub-bottom profiler, sísmica de reflexión de alta resolución y sísmica con fuente profunda (deep towed sidescan sonar); con el fin de investigar las estructuras de fallamiento en el talud y buscar sitios activos de escurrimiento. Además se tomaron tres núcleos de gravedad con sedimentos hemipelágicos en la placa oceánica, en sitios donde se realizaron perfiles de refracción; así como otros 10 núcleos en dos deslizamientos estudiados en el talud continental. Un total de 34,6 m de núcleos de perforación fueron recuperados de la corona del escarpe, el olistolito, cono de escombros y sitios de referencia no perturbados por los dos deslizamientos, así como de la placa oceánica. El deslizamiento superficial, llamado "Valdés" fue encontrado en la pared oriental de una estructura similar a una dorsal, la cual termina en una cuenca sedimentaria hacia el lado inclinado del talud continental. El segundo deslizamiento fue encontrado a 5000 m bajo el nivel del mar. Los depósitos de este deslizamiento, llamado "Reloca", pudieron ser continuados a través de la fosa. Dos áreas fueron inspeccionadas con el sonar de barrido lateral (sidescan sonar) con el objeto de encontrar zonas activas de escape de fluidos, elegidas con base en estructuras interesantes mostradas en los datos batimétricos. Sólo en la zona de estudio localizada más al sur (36°20' S) se descubrieron tres zonas activas de escapes de fluidos. Durante la inspección del sonar se observaron claras emanaciones de intensidad variada en la señal de 70 kHz de retrodispersión. Los sitios están localizados en la cima de un escarpe a 600 m de altura que corresponde a aproximadamente 1000 m de profundidad bajo el nivel del mar.

2. Aims of the cruise JC23

This cruise is an integral part of the work that is being performed within the Sonderforschungsbereich 574 (Collaborative Research Center, SFB 574) of the Deutsche Forschungsgemeinschaft (German Research Foundation). The SFB 574 has passed two phases (2001-2004, 2004-2008) focussing on the erosive continental margin off Central America. In order to extrapolate the results to global scales, from the very beginning of the work it had been projected to integrate studies on an accretionary continental margin. The Chilean continental margin was chosen as study area for this purpose.

The cruise will be divided into two legs. The working plan for Leg 1 comprises deploying a seismological short-term grid in the outer rise area and recording three combined onshore-offshore wide-angle profiles. The seismological short-term grid is to be recovered and replaced by a long-term grid (to remain until October 2008) by the end of the second leg. The main aim of the second leg, however, will be mapping.

The main objective of the seismic and seismological work is to study the influence of a potentially existing serpentinisation on the subduction process and on the release of fluids. Serpentinisation of the oceanic lithosphere may occur directly at the ridge during formation or later by an intrusion of sea water along stretching faults at the outer rise. Fluids released from the subducting plate may get into the mantle wedge of the upper plate and lead to a formation of serpentinite and brucite. The change from competent, dry rocks to soft mineral parageneses with a high water content is presumed to have a great influence on maximum rupture stress as well as on the down dip limit of the seismogenic zone (Hyndman and Peacock, 2003).

In the mantle of the subducting plate off Nicaragua, past SFB studies have revealed velocity changes from 8.1-8.2 km/s to 7.4 – 7.6 km/s from the outer rise to the deep sea trench, indicating possible serpentinisation of up to 20% in the upper mantle (Grevemeyer et al., 2007). Thus, mantle serpentinite has the largest share in fluids being introduced into the subduction zone. In the working area off Central Chile, however, the oceanic crust and the deep sea trench are covered by an up to 2000-m-thick sediment layer, which is supposed to reduce the intrusion of sea water along the stretching faults. It can be assumed that the amount of fluids introduced into the subduction zone by the oceanic plate is far smaller.

Seismic experiments are the most promising technique for determination of the amount of water bound in mantle rocks (Carlson and Miller, 2003). Seismic wide-angle profiles and local earthquake monitoring data can be used to deduce the velocity field of the subducting plate and the forearc region. Serpentinisation of the upper mantle of the subducting plate leads to a significant reduction of speed that can be easily identified. Our experience from Central America, however, has shown that due to the low velocity gradient in the upper mantle penetration depth is often quite limited. A combination of active measurements and local earthquake monitoring, however, allows a deeper penetration. Earthquakes in the outer rise area may reach into depths of up to 20 km (Lefeldt and Grevemeyer, submitted). In addition, earthquake hypocentres may illuminate the maximum depth of the stretching faults and the maximum depth of fluid intrusion. Velocity changes caused by mantle serpentinisation should also be visible in the delay times of distant earthquakes. In addition, an angle dependency of the delay times may help to differentiate between velocity changes caused by microfractures and/ or serpentinisation.

In order to cover the forearc mantle, we are planning to use seismic broadband stations between the coast and the central Andes. 20 stations provided by us will be complemented with 20 more stations installed by our Chilean partners in the volcanic belt region (as part of the Chilean “Giant Ore Deposits” project). We expect to gain the most important information from the receiver functions. Furthermore, tomographic inversion of near earthquakes and shot signals produced at sea will allow conclusions on structural variability of the forearc mantle. Changes of the V_p/V_s ratio and anisotropy will provide information about the effect of fluids on the structure of the mantle wedge and the extent of hydration.

The following steps are to be taken in order to achieve the above-mentioned aims:

Seismic wide-angle data are to be shot along three profiles of 100 nm length each. For this purpose, each of the profiles will be equipped with 30 OBS stations. In addition, the air gun shots will be registered by a seismological network in the outer rise area (20 stations). Furthermore, the shots will be recorded by 12 broadband OBS which are part of the 6-month seismological network above the seismic coupling zone. On land, a total of 40 broadband stations (20 German stations, 20 Chilean stations) and 20 additional short-period stations (10 Chilean stations, 10 German stations) will record the airgun shots in respective elongation of the marine profiles (see Fig. 2.1). At the end of the second leg, the 20 stations of the outer rise network will be recovered for another deployment in the area between the deep sea trench and the coast. Together with the 12 broadband OBS and our 20 broadband land stations they will be recovered in October 2008. For this purpose, a Chilean ship will be chartered, as such arrangements have been successful in the past.

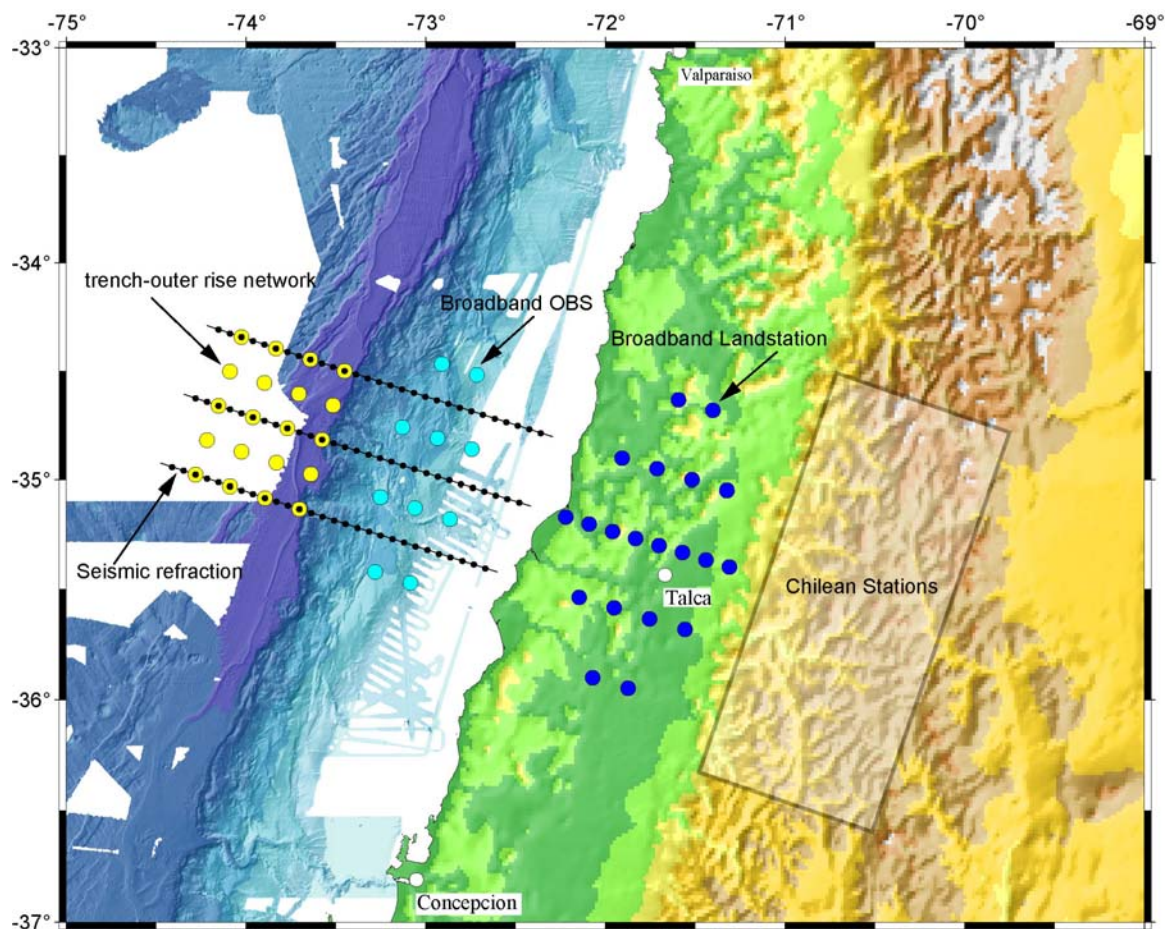

Figure 2.1: *Seismological stations and deep seismic profiles.*

The second leg (Fig. 2.2) is planned to focus on mapping by bathymetry combined with the deep-towed geoaoustic DTS system (sidescan sonar, subbottom profiler and multichannel streamer). The resulting data will serve for studying the relation between tectonic processes, sediment transport and fluid venting at the accretionary continental margin off central and southern Chile. The results are to be compared to those from the erosive continental margin off Central America. In contrast to the Central American subduction zone, the area off Chile appears to be characterised by an introduction of massive terrigenous sediments into the subduction zone.

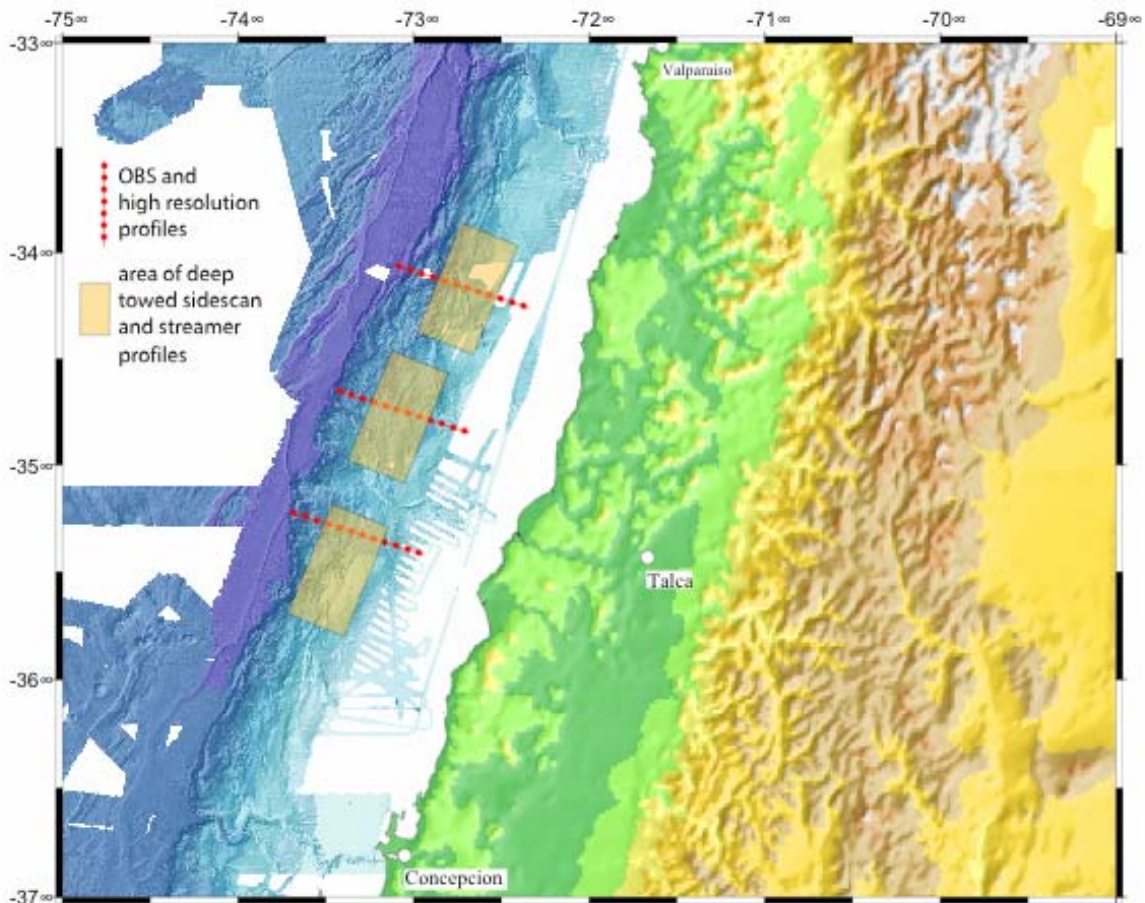

Figure 2.2: *Planned location of high resolution profiles and the areas to be covered by the deep-towed sidescan and streamer*

Sediment cores of ODP station 1235 (36°09.594' S, 73°33.983' W, 489 m depth) contained up to 100% terrigenous components accompanied by a very high sedimentation rate of more than 80 cm / kyr (Mix et al., 2003). At the same time, several horizons contained carbonate precipitates that were either deposited in the form of nodules (2-15 cm) or as a finely distributed filling of the pore space. An occurrence of massive carbonates can be interpreted as a sign of active fluid flux, which is the only mechanism that would ensure transport of sufficient amounts of soluted components to the place of precipitation (Luff et al., 2004). Sediment samples have shown to be very rich in gas, almost exclusively methane (R. Tiedemann, pers. comm.).

The observation that the gas is of predominately biogenic origin (low concentration of ethane) matches the fact that the area of investigation is characterised by strong coastal upwelling (Fossing et al., 1995). In this connection, decreasing contents of biogenic opal

and diatoms point at a distinct variation of regional productivity (Romero and Hensen, 2002). However, examinations of pore water from core samples show an influence of fluid flux from the deeper basement. Concentrations of dissolved chlorine and sodium salts decrease towards the end of the core, whereas contents of boron, calcium and strontium increase. Assuming that such changes of concentration result from a conversion from smectite to illite in the deeper basement, according to Hensen et al. (2004) a rise of fluids from the deeper regions of the upper plate or even the subducted sediments can be assumed. Similar observations were made at ODP station 1234 (36°13.153' S, 73°40.902' W). The offshore part of the oceanic plate is also covered by sediments that are predominantly terrigenous and rich in gas (ODP 1232, 39°53.45' S, 75°54.08' W, 4072 m). Apart from elevated values found for heat flux and methane content on the SO161-5 cruise, information gained on a Danish cruise using the Chilean research vessel "VIDAL GORMAZ" concerning the location of several mud volcanoes on the middle continental slope provides the clearest evidence of active fluid venting in the area of investigation. Further indicators of active fluid circulation were found in the gravity cores M67-17 and M67-18 (Weinrebe and Schenck, 2006).

Between 33°30' S and 36° S, the bathymetry of the continental slope can be divided into three morphological segments. The area of investigation is mostly made up of the the middle segment with a seaward displacement of the continental margin. Based on previous knowledge and on the bathymetry to be performed, three seismic high-resolution profiles (MCS and OBS) are planned on the continental slope. One profile is to run across the center of the prolonged slope, the other two south and north of the central profile respectively. Combined with wide angle recordings of 30 OBS, the resulting data are going to provide a comparative image of the structural change.

In addition, three areas on the middle slope are to be mapped using the deep-towed DTS system (streamer, sidescan sonar and subbottom profiler). The resulting data will provide further information about the distribution of hydrates and mounds. While the sidescan sonar allows high-resolution imaging of changes in seafloor morphology, the measurements performed parallelly with the subbottom profiler and the deep-towed streamer will produce seismic images of the subsurface covering different wave bands and penetration depths. This type of mapping will result in a comprehensive picture providing information on the distribution of the BSR and possible mound structures. DTS imaging of Mound Culebra off Costa Rica and of the continental margin off Nicaragua (Talukder et al., 2007) has shown that this technique allows characterising mound structures and retracing their history of formation, thus extending the basis of knowledge required for understanding continental margin dynamics. Furthermore, the data can be used for map calibration to achieve an exact positioning of video-guided systems such as the OFOS and for sampling devices. This has been done successfully on several cruises (e.g. SO191, M72-4). Only the above-described combination of large-scale to small-scale observation and surveying will provide a comprehensive representation of the slope characteristics that can be used for detail work on cycles within the accretionary continental margin.

At the lower continental slope, swath bathymetry data from past SONNE cruises show bathymetric structures typically associated with submarine landsliding. Between 35.5°S and 36.6°S a total of three slides covering areas of 95, 340 and 670 km² respectively have been identified (Völker and Weinrebe, 2006). Mass balancing and modelling of slide dynamics requires a survey of the slide masses by detailed swath bathymetric mapping. If the subbottom profiler is used parallelly, there will be a complementary depth section to be combined with the resulting structural surface observations.

For Costa Rica, a causal relationship has been postulated between individual slides and fluid vents at the continental slope (Petersen et al., 2006). It is not yet clear whether networks of fluid paths concentrated on one plane act as weak layers defining the basal shear plane of a slide in a case of external (seismic) triggering or whether slides and vents are both expressions of the same tectonic stress. In order to verify whether there is a spatial relationship between vents and slides in Chile as well and to understand the connection between fluid circulation, slides and tectonic lineaments, searching for and mapping mud volcanoes, carbonate mounds and other microbathymetric structures associated with fluid venting appears to be the method of choice. For this purpose, the slide headzone has to be mapped using the deep-towed side scan sonar.

The basal shearing zone of a slide is most likely to be exposed directly below the upper tear-off edge of a landslide. At least, at this place it will not be covered by much more than a thin layer of sediments deposited after the sliding event. In this zone, there is a possibility of getting an approximation of the age of the structure based on high-resolution seismics and Parasound data, as the seismic facies of hemipelagic sediments deposited after the sliding should be clearly different from that of the sediments deformed by the sliding process, so that a clear separation should be possible in high-resolution seismic data. The thickness of the undisturbed sediment column overlying the shearing plane provides an approximation of the age of the sliding mass, as approximate sedimentation rates are known from ODP cores. This approach requires mapping of the slide headzone using the subbottom profiler.

3. Participants

3.1 Scientists

JC 23A

Prof. Dr. Ernst R. Flüh

Thomas Brandt
 Wiebke Brunn
 Anke U. Dannowski
 Ines Dumke
 Jasmin Floss
 Lisa E. Flüh
 Javiera Gonzalez
 Pachoenchoke Jintasaeranee
 Marten R. Lefeldt
 Sandra Meissl
 Swen Meyer
 Illka Riepenhausen
 Jörg-Stephan Schäfer
 Patrik P. Schroeder
 Martin M. Thorwart
 Martin Wollatz-Vogt

IFM-GEOMAR, Chief Scientist

IFM-GEOMAR
 IFM-GEOMAR
 IFM-GEOMAR
 IFM-GEOMAR
 IFM-GEOMAR
 IFM-GEOMAR
 Pontificia Universidad Católica de Valparaiso
 IFM-GEOMAR
 SFB 574
 IFM-GEOMAR
 IFM-GEOMAR
 IFM-GEOMAR
 IFM-GEOMAR
 IFM-GEOMAR
 SFB 574
 SFB 574

JC 23B

Dr. Jörg Bialas

Jonas Behrmann
 Wiebke Brunn
 Markus Fink
 Jasmin Floss
 Matthias Frische
 Martin Jacques-Coper
 Pachoenchoke Jintasaeranee
 Dr. Dirk Klaeschen
 Dr. Ingo Klaucke
 Prof. Dr. Sebastian Krastel-Gudegast
 Sandra Meissl
 Eduardo Moscoso
 Mónica Ingles Páez
 Anne-Dörte Rohde
 Jörg-Stephan Schäfer
 Patrik P. Schroeder
 Dr. Michael Stipp
 Lucia Alejandra Villar
 Dr. David Völker
 Dr. Wilhelm Weinrebe

IFM-Geomar, Chief Scientist

IFM-GEOMAR
 IFM-GEOMAR
 IFM-GEOMAR
 IFM-GEOMAR
 SFB 574
 Universidad de Chile
 IFM-GEOMAR
 IFM-GEOMAR
 IFM-GEOMAR
 Exzellenz Cluster Universität Kiel
 IFM-GEOMAR
 Pontificia Universidad Católica de Valparaiso
 Pontificia Universidad Católica de Valparaiso
 IFM-GEOMAR
 IFM-GEOMAR
 IFM-GEOMAR
 IFM-GEOMAR
 Pontificia Universidad Católica de Valparaiso
 SFB 574
 IFM-GEOMAR

3.2 Crew

JC 23A

Peter C Sarjeant	Master
Philip D. Gauld	Chief Officer
Titus A. Owoso	2nd Officer
Michael P. Hood	3rd Officer
John M. Holt	Chief Engineer
John A. Hagan	2nd Engineer
Lee D. Harding	3rd Engineer
Michael J. Myers	Scientist System Manager
Vivian M. Wythe	Deck Engineer
Paul D. Lucas	Purser Catering Officer
Thomas Lewis	Deck Bosun
Stephen J. Smith	Scientist Bosun
Andrew Maclean	Deck Bosun Assistant
Charles H. Cooney	Seaman
Sthepen Setters	Seaman
Daniel N. Loveridge	Seaman
Colin J. Birtwhistle	Seaman
John G. Smyth	Engineerroom PO
Peter A. Lynch	Head / Chef
Lloyd Sutton	Chef
Graham Mingay	Steward
Dean A. Hope	Technicians
Christopher Barnard	Technicians
Christopher Hunter	Technicians
Emma L. Northrope	Technicians
Jason Scott	Technicians
Lee C. Sheldon	Technicians
Neil A. Sloan	Technicians
Darren Young	Technicians

JC 23B

Peter C Sarjeant	Master
Philip D. Gauld	Chief Officer
John W. Mitchel	2nd Officer
Michael P. Hood	3rd Officer
John M. Holt	Chief Engineer
John A. Hagan	2nd Engineer
Lee D. Harding	3rd Engineer
Ian R. Wight	ETO
Michael J. Myers	Scientist System Manager
Thomas E. Levy	Deck Engineer
Paul D. Lucas	Purser Catering Officer
Thomas Lewis	Deck Bosun

Stephen J. Smith	Scientist Bosun
Andrew Maclean	Deck Bosun Assistant
Charles H. Cooney	Seaman
Stephen P. Day	Seaman
Daniel N. Loveridge	Seaman
Robert Spencer	Seaman
John G. Smyth	Engineerroom PO
Peter A. Lynch	Head / Chef
Lloyd Sutton	Chef
Jacqueline Paterson	Stewardess
Dean A. Hope	Catering Assistant
Paul A. Duncan	Technicians
Allan Davis	Technicians
Emma L. Northrope	Technicians
Darren Young	Technicians

3.3 Addresses of Participating Institutions

IFM-GEOMAR:	Leibniz-Institut für Meeresforschung der Christian-Albrechts-Universität zu Kiel Wischhofstr. 1-3 24148 Kiel Germany Tel.: +49 - 431 - 600 - 2972 Fax: +49 - 431 - 600 - 2922 e-Mail: Iname@ifm-geomar.de Internet: www.ifm-geomar.de
SFB 574:	Sonderforschungsbereich an der Christian-Albrechts-Universität zu Kiel Wischhofstr. 1-3 24148 Kiel Germany Tel.: +49 - 431 - 600 - 2972 Fax: +49 - 431 - 600 - 2922 e-Mail: Iname@ifm-geomar.de Internet: www.ifm-geomar.de
Cluster of Excellence: The Future Ocean	Exzellenzcluster »Ozean der Zukunft« Christian-Albrechts-Universität zu Kiel Olshausenstr.40 24098 Kiel Germany Fax : +49 - 431-880-2539 e-mail: info@ozean-der-zukunft.de Internet www.future-ocean.de

**Pontificia Universidad:
Católica de Valparaíso**

Facultad de Ciencias
AV. Altamirano 1424
Valparaíso
Chile
Tel.: +56-032-2274265
Fax: +56-32-2273183
Internet: www.ucv.cl

Universidad de Chile:

Facultad de Ciencias Físicas y Matemáticas
Av. Beauchef 850
Santiago
Chile
Tel: + 56 – 2 - 978 4000
Fax: + 56 – 2 - 6712799
e-mail: comunicaciones@ing.uchile.cl
Internet: www.uchile.cl



**James Cook
Chile Cruise 2008
JC 23a
03.03.08 – 25.03.08**



Ernst Flüh



Anke Dannowski



Marten Lefeldt



Wiebke Brunn



Martin Thowart



Patrick Schroeder



Ines Dumke



Jörg Schäfer



Ilka Riepenhausen



Martin Wollatz-Vogt



Thomas Brandt



Pachoenchoke
Jintasaeranee



Swen Meyer



Jasmin Floss



Lisa Flüh



Sandra Meissl



Javiera Gonzalez

Figure 3.1.1: Participants of cruise JC23a



Figure 3.1.2: *Participants of cruise JC23b*

4. Agenda of cruise JC23

Leg 1

Cruise JC 23 A started on March 02, 2008, in Valparaiso, Chile. Altogether 17 scientists embarked on RV JAMES COOK in Valparaiso, comprising the international group of scientists from Austria, Chile, Germany and Thailand. The transit from Valparaiso to the study region was delayed until 19:30 03.03.2008, due to the late arrival of airfreight. The time was intensely used for the preparation of the scientific equipment and installation of hardware, including a gravity tie.

On 04th of March at 04:00 a releaser test was made to 3200 m depth, and a sound velocity probe was run at the same cable. We then started to deploy ocean bottom seismometers that comprised a short-term (6 weeks) Outer Rise and a long term (7 month) Chile Margin seismological network. In total 24 instruments were deployed until 06.03.2008, partly in adverse weather conditions.

On Friday 07th of March 25 instruments were deployed along Profile 01 at an average spacing of 3.5 nm. Shooting along this profile started in the morning of 8th of March and lasted for more than 30 hours. Towards the end of the line a short cross profile (P11) was added. The airgun array consisted of 14 single guns with a total volume of 11500 cubic inch (186 Liters), one of the largest arrays ever used for wide-angle profiling. It turned out however, that one single element airgun had to be taken out in order to prevent severe damage. During shooting a magnetometer and a streamer were also deployed.

Monday and Tuesday 10th and 11th of March 2008 were used for the recovery of the OBS along this line, and this was followed by the deployment of these instruments along Profile 03. Here also three magnetotelluric stations were deployed. 13th and 14th of March were used to shoot the airgun array along this line, in a similar fashion as for Profile 01. Near the coast a 15 nm long coast parallel line (P33) was added.

A partial recovery and further deployment of additional four MT-stations was accomplished on 15.03.2008, and 8 instruments were deployed along a short profile on the Nazca plate (P04), connecting profiles 01 and 03. Shooting along this 45 nm long profile was finished in the afternoon of 16.03.08. Subsequently instruments from Profile 04 and from Profile 03 were all safely recovered, and a ninth MT-station was deployed.

Profile 02 was started at midday 18.03.08 with the deployment of 19 instruments. These were augmented by 4 stations deployed on the outer rise before and additionally by four land stations. Shooting along this line started in the morning on 19.03.2008 and was done at 4 knots with an interval of 60 sec. Due to poor weather conditions the airgun array had to be reduced in volume in the middle of the profile. Close to the coast a 15 nm long perpendicular line (P22) was shot in addition using a slightly smaller array and a 40 sec shot interval. Recovery of all instruments was completed 22.03.08, and an additional seismometer had been deployed for long-term seismological observations.

The final activity was the deployment of a tiltmeter, 3 methane sensors and three more OBS close to the coast for test purposes (P08 and P81). At first two GI-guns were fired across the three OBS, followed by shooting with a single subarray of three Boltguns in the reverse direction. The shots were also recorded on a four channel streamer. By midnight, the three OBS had been recovered. We then started a 200 nm transit to leave the Chilean EEZ as required due to customs regulation. The transit was used to collect additional bathymetric data, and the magnetometer was also deployed.

The James Cook entered the harbor of Valparaiso 25.03.08 at 08:00, terminating a rather successful cruise.

In Figure 4.1. a track plot of JC23 Leg 1 is shown.

Leg 2

During the port call of the James Cook from 25th to 27th March part of the science crew was exchanged and the large airgun array was changed to three GI guns with 1065 cinch in total to serve the high resolution requirements during the coming leg. In the morning of 27th March James Cook left the port of Valparaiso at 8:30 hrs setting course south. During the night the 3 methane sensors and the tiltmeter were recovered. After a 200 nm transit 17 OBS were deployed across the Chilean margin at 35°:45' S (P09). At 22:00 the new IFM-GEOMAR three gun GI array was deployed the first time. On the 29th 21:00 all OBS had safely been recovered after completion of 11 hours of airgun shots. The night was used to accomplish a bathymetry and sub-bottom profiler reconnaissance across the margin towards the first DeepTow survey. A set of 13 OBS was deployed across possible mud volcano structures in about 1.500 m water depth (P10). At 11:00 on the 30th March the DeepTow streamer and sidescan were deployed about 25 miles off the coast. Despite careful testing and preparation the DeepTow streamer failed after short time of service in about 1200 m water depth. As the sidescan was still in operation, and airgun shots were recorded by the deployed OBS and a 4 channel surface streamer the survey was continued. After the end of the first line the DeepTow was recovered and redeployed without the broken streamer system. It turned out that the control PC in the tow fish went out of service. The survey was continued with deep towed sidescan, 4 channel surface streamer and airguns without further problems until 23:15 on the 01st April. With reduced speed bathymetry and sub-bottom profiler reconnaissance were continued until recovery of the deployed OBS. Further possible targets for a deep towed survey indentified on the bathymetry map and the seismic images of the VG02 cruise were investigated by sub-bottom profiler tracks north of the first DeepTow area until 03rd April. On 08:00 a first gravity core was taken from the top of a major slump that has been covered with the first OBS profile of leg 2. Technical problems delayed a second core and therefore the nearby OBS-701 of the short term network deployed during leg A was recovered and redeployed to fill in the long term network until October 2008. Between 20:00 and 02:00 on the 04th April a second and third coring attempt was completed. Due to a failure in the winch control coring schedule was interrupted and the James Cook headed for a 400 nm round trip to recover the short term seismology network and to redeploy instruments on the slope and shelf to complete the gap between the offshore and onshore long term seismology network. Underway three successful cores could be recovered on the oceanic plate with 4m, 5 m and 7.4 m core content. In addition eight MT stations were recovered, which occupied an amphibious profile towards the Chilean coast where it was extended by onshore stations. Unfortunately the 9th instrument did not reply to the release. During the night of 7th / 8th April 19 OBS were deployed along two lines covering the "Valdés" slump site (P11). The deep towed sidescan, a single 210 cinch GI airgun and a short surface streamer were towed along seven profiles covering the slump and its side walls. Before recovering the OBS the ship left for the missing MT station in order to be at the location when the time release is activated. Unfortunately it did not show up. Heading south three gravity cores were taken from the "Valdés" slump on Friday 11th April. Thereafter we continued the journey to an area off Talcahuano at 36° 25' S. Deployment of 19 OBS was followed by a survey with the deep towed sidescan on 12th and 13th April (P12). During this survey three sites with flares in the water column were observed. Upon recovery of the sidescan weather conditions had become bad enough to stop recovery of the OBS after the sidescan was broad onboard again. After 20 hrs weather conditions calmed down and the 19 OBS could safely be recovered. After 80 nm of transit we returned on 15th April to the "Reloca" slump at 5000 m water depth. Four cores were taken across the slump deposit before we were heading further North. On 16th April, a final GI airgun survey with the small streamer was compiled across two promising volcano

like structures on the seafloor in 5000 m water depth. Seismic operations were terminated with the end of this survey and the remaining time was used to complete the bathymetric map before leg JC23-B ended in the morning of the 18th April Valparaiso. In Figure 4.2. a track plot of JC23 Leg 2 is shown.

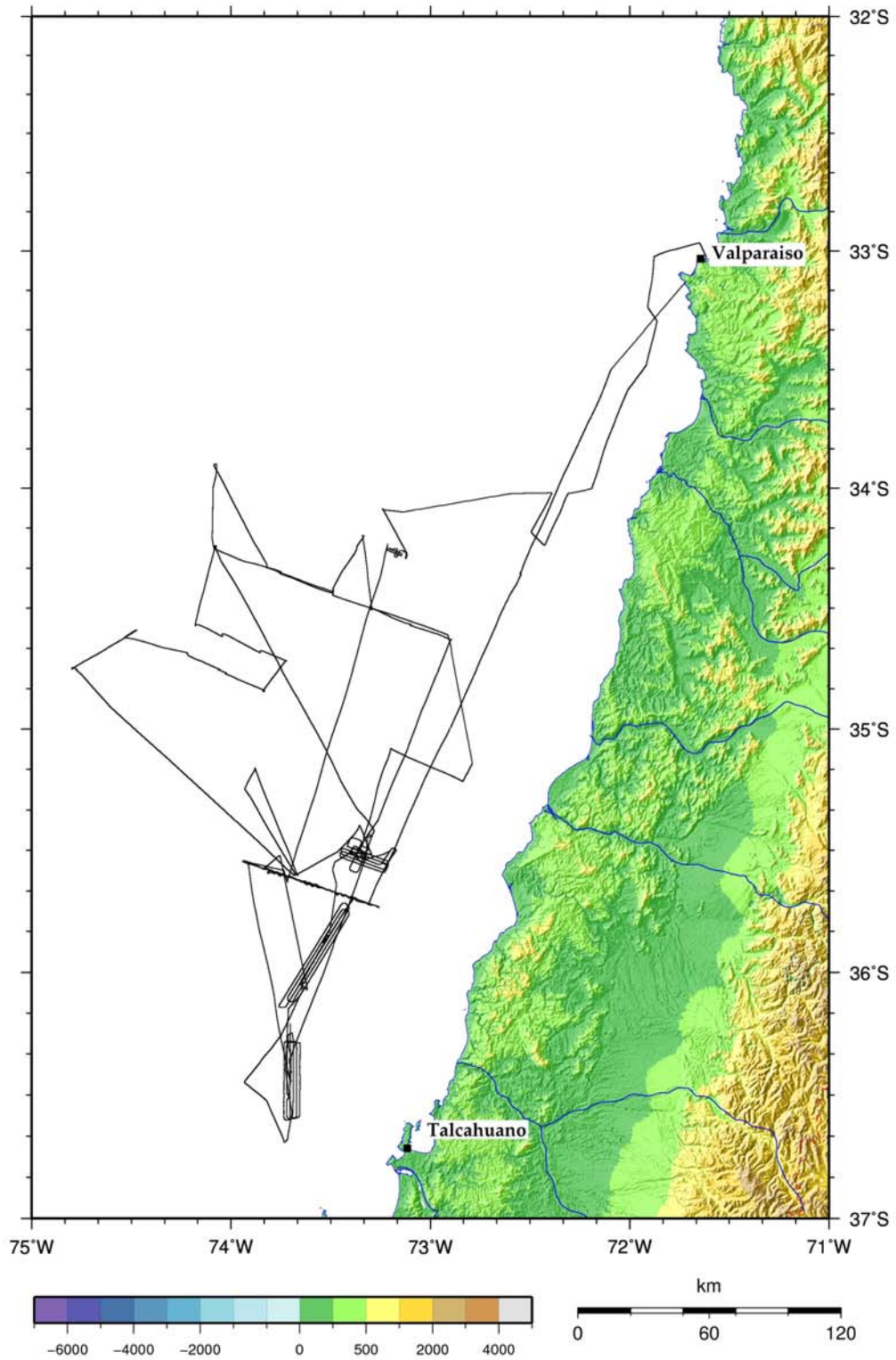

Figure 4.2. : Track chart of cruise JC23 Leg 2

5. Seismic Investigation

5.1 Seismic Instrumentation

5.1.1 OBH/OBS

The first IFM-GEOMAR Ocean Bottom Hydrophone was built in 1991 and tested at sea in January 1992. This type of instrument has proved to have a high reliability; more than 4000 successful deployments were conducted since 1991. A total of 40 OBS instruments were available for JC23. Altogether 178 sites were deployed for wide angle seismic profiles during the JC23 cruise.

The IFM-GEOMAR Ocean Bottom Seismometer 2002

The IFM-GEOMAR Ocean Bottom Seismometer 2002 (OBS-2002) is a new design based on experiences gained with the IFM-GEOMAR Ocean Bottom Hydrophone (OBH; Flueh and Bialas, 1996) and the IFM-GEOMAR Ocean Bottom Seismometer (OBS, Bialas and Flueh, 1999). For system compatibility the acoustic release, pressure tubes, and the hydrophones are identical to those used for the OBH. Syntactic foam is used as floatation body again but compared to the IFM-GEOMAR OBH/S in a less expensive cylinder shape. The entire frame can be dismantled for transportation, which allows storage of more than 50 instruments in one 20" container. Upon cruise preparation onboard all parts are screwed together within a very short time. Four main floatation cylinders are fixed within the system frame, while additional disks can be added to the sides without changes. The basic system is designed to carry a hydrophone and a small seismometer for high frequency active seismic profiling. The sensitive seismometer is fixed between the anchor and the OBS frame, which allows good coupling with the sea floor. The three-component seismometer (*KUM*) is housed in a titanium case, modified from a package built by Tim Owen (Cambridge) earlier. Geophones of 4.5 Hz natural frequency were used. The signals of the sensors are recorded by use of the *Marine Broadband Seismocorder (MBS)*, *Marine Longterm Seismocorder (MLS)*, *Marine Exploration Seismocorder (MES)* and *Marine Tsunami Seismocorder (MTS)*, which are all manufactured by *SEND GmbH*.

While deployed to the seafloor the entire system rests horizontally on the anchor frame. After releasing its anchor weight the instrument turns 90° into the vertical and ascends to the surface with the floatation on top. This ensures a maximally reduced system height and water current sensibility at the ground (during measurement). On the other hand the sensors are well protected against damage during recovery and the transponder is kept under water, allowing permanent ranging, while the instrument floats at the surface.

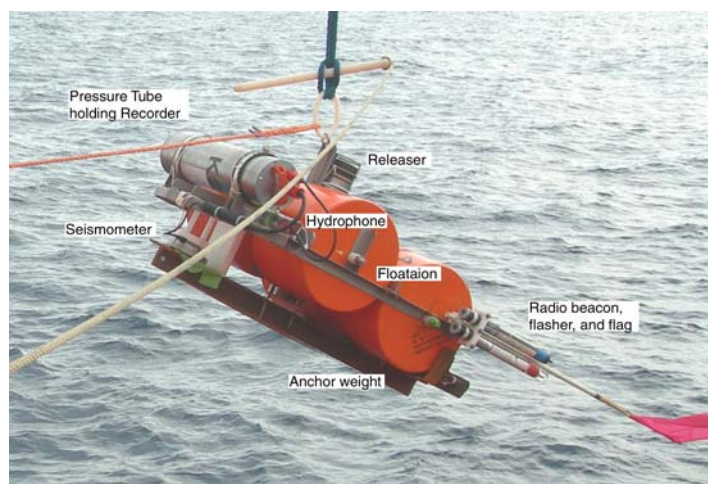

Figure 5.1.1.1: OBS – design 2002

The LOBSTER

The *Longterm Ocean Bottom Seismometers for Tsunami and Earthquake Research (LOBSTER)* built by *KUM GmbH* are deployed as lonterm stations in a seismological network. They belong to the instrument-pool of the *AWI (Alfred-Wegener-Institut Bremerhaven)*. The Datalogger is a *MCS (Marine Compact Seismocorder)* manufactured by *Send GmbH* and records one channel of a HighTech Hydrophone and three channels of the three-component seismometer (Güralp CMG-40T in a titanium case). The Seismometer is coupled to the seafloor by the ancor of the LOBSTER.

For more information see <http://www.awi.de>.

Reflection seismic data acquisition (mini-streamer)

In addition to the ocean bottom seismic recorders for cruise JC23 a 4 channel mini-streamer was used. The streamer was deployed along the profiles, where the OBH/S profiles were conducted. The streamer was manufactured by *S.I.G. (Service et Instruments de Geophysique, France)*. The system comprises several parts: four 12,5 m long active sections with 24 hydrophones spaced at 0.5 m. The active length is 65 m and the lead-in cable is 150 m long and directly connected to the lab. The individual hydrophones are omnidirectional. The hydrophones are mounted in an oil filled polyurethane pipe. The tow depth can be controlled by supplying the lead-in cable with air or water and the depth can be monitored at the depth monitor integrated in the system with the power supply. The streamer had to be deployed and recovered manually.

A four channel MBS data logger was used to record the seismic signals of the airgun shots. Direct water wave arrival and reflection signals could be observed using the online display capabilities of the MBS device.

To better adopt the signals provided by the streamer to the dynamic range of the MBS recorder 100 k resistors were put into the connector plugs. They allowed to record a single GI airgun without clipping of the water wave or the seafloor arrival using an amplification of 15 with the MBS channels.

When operating three GI airguns with 250 cinch generator it was found that the amplification need to be reduced to three for the MBS but still artefacts are visible in the data. Such could only be explained assuming that the streamers hydrophones do see to high pressure arrivals in case of shallow water depth operation (< 2000 m). This need to be further investigated by pressure models for the array configuration.

5.1.2 Airgun Systems

JC23-A:

As the main source airgun arrays were operated in four arrays plus two single Bolt airguns. Each array comprises three airguns, one each with 500 inch³, 600 inch³ and 700 inch³ volume. The Bolt airguns have a volume of 2000 inch³ each. The towing configuration of the array is shown in the lower picture. The guns were operated at 150 bar. Profiles were shot at 40s and 60s shot interval.



Figure 5.1.2.1: *Picture of two airgun arrays with 3 guns each*

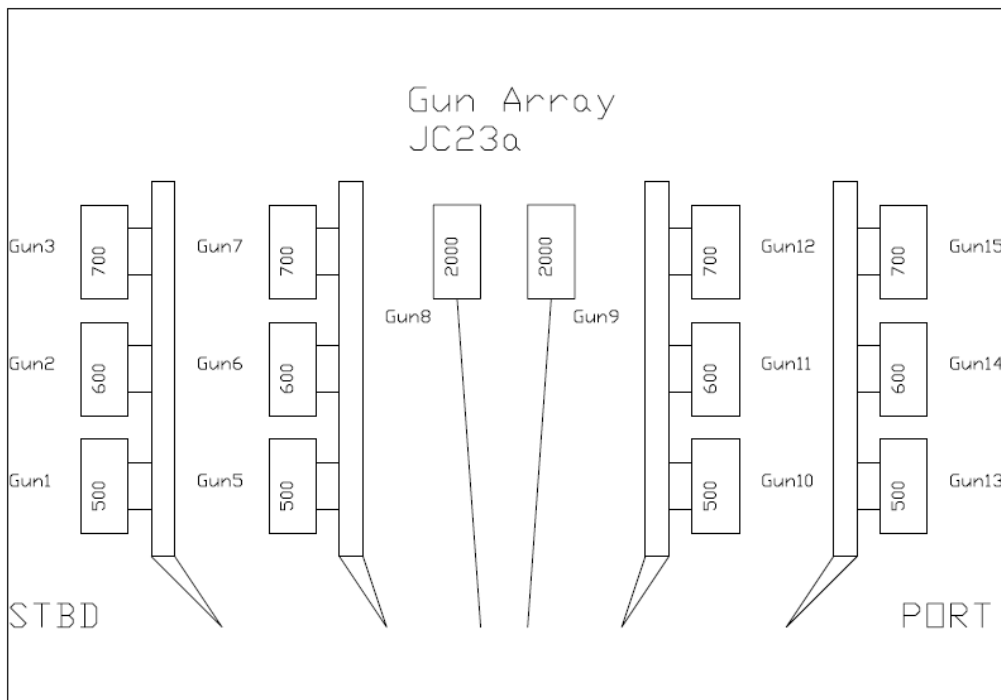

Figure 5.1.2.2: *The airgun array of the JC23-A cruise*

JC23-B:

Major interest during the second leg JC23-B was dedicated to small scale structures like slumps, gas hydrate deposits, fluid migration path and seep sites. Consequently a source array with increased signal frequency was required. Thanks to two recently purchased GI guns IFM-GEOMAR was able to equip one of the British gun deployment frames with three GI airguns. All were equipped with a 250 cinch generator and a 105 cinch injector chamber.

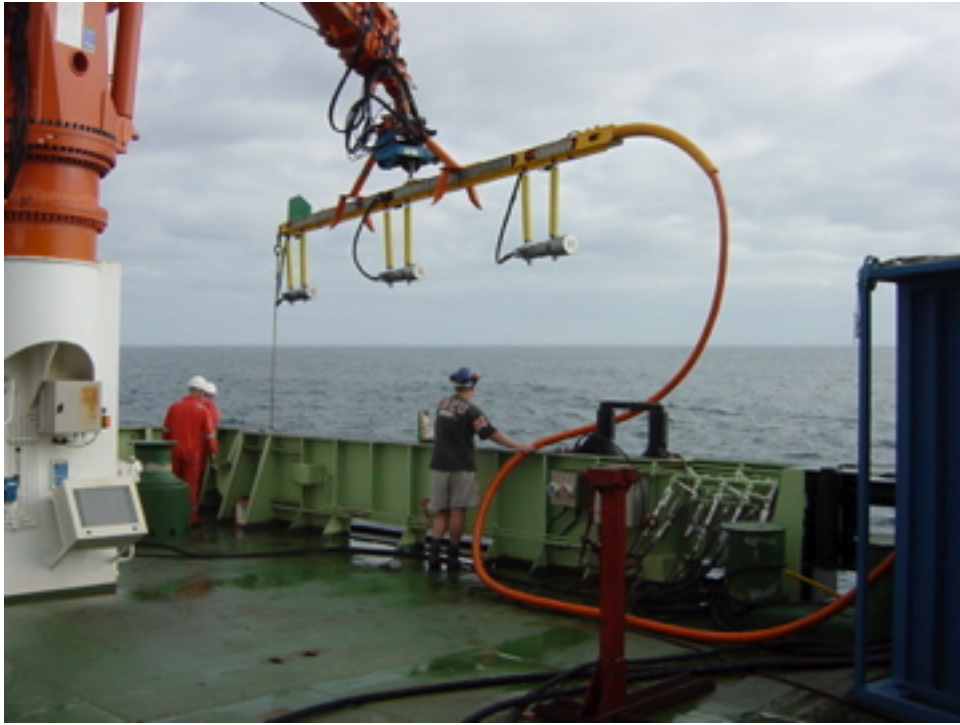

Fig.: 5.1.2.3: *Airgun deployment frame with three GI airguns*

The guns were towed at 5 m depth. Trigger interval was 13 sec and a generator / injector delay of 54 msec was chosen according to the 150 bar operation pressure.

Increased resolution requirements were served by usage of a single GI airgun with 105 cinch generator and 105 cinch injector, towed at 2 m depth. The gun was fired every 6 sec with a generator / injector delay set to 56 msec.

5.1.3 Seismic data processing

During cruise JC23 numerous seismic profiles were collected, using ocean bottom recorders and a four channel. During leg JC23-A an array of Bolt airguns with up to 11000 cinch was used, while leg JC23-B used two GI airguns. All instruments are described in chapter 5.1.

Seismic Processing: OBH/OBS Wide Angle Data and Reflection Data

The OBH/S data recorded in continuous mode on the MLS and MBS units have to be converted into standard trace-based SEG-Y format for further processing. The necessary program structure was mainly taken from the existing REFTEK routines and modified for the OBS requirements and IFM-GEOMAR's hardware platforms.

Send2X

For the PC-cards used with the MBS and MLS recorders, data expansion and format conversion into REFTEK data format is performed using a Linux based PC. The software bundle Send2X reads data from the flashcards used during recording. Decompressed data are written onto the PC's hard disk using PASSCAL data format. Either 16 or 32 bit storage is available and all other software can be used to handle and process the data files and store them as SEG-Y traces.

While processing the MLS recordings time slips arise because the clock rate of the crystal oscillator in the MLS recorder is temperature dependent (Klaus Schleisiek, SEND GmbH, pers. comm.). The temperature dependence is known and corrected for in the determination of the system time, but for performance reasons the sampling pulses are directly generated from the oscillator signal without any time correction. The „resample“ routine corrects for this time slips but may only be used with MLS data.

For all data sets the skew values (drift of the internal clock) were set to zero with the xxxREAD programs in order to avoid inconsistent skew handling within the SEND2X package. The skew correction will be done for all stations during the „dat2segy“ sequence.

ref2segy

The ref2segy program converts the output of send2pas to a pseudo SEG-Y trace consisting of one header and a continuous data trace containing all samples, as used by the PASSCAL suite of seismic utility programs. For each channel (normally pressure, vertical velocity, and velocity along two mutually perpendicular horizontal directions for OBS; pressure for OBH) one file is created with the name derived from the start time, the serial number of the Methusalem system, and the channel number. The file size of the pseudo-SEG-Y file is directly related to the recording time. For instance, a recording time of one hour sampled at 200 Hz (16 Bit) will produce a file size of 1.44 MB per channel. A record with two channels and a recording time of two days will produce a total data volume of 70 MB.

pql

pql (Passcal Quick Look) is a simple display program for continuous seismic data. Its interactive zooming capability allows a rapid inspection of data quality.

segy2trig

The trigger signal, provided by the airgun control system, is recorded on an additional MBS unit during the shooting period. The trigger data are treated similarly to regular seismic data and downloaded to the hard disk via the send2pas and ref2segy programs. Then, the segy2trig program detects the shot times in the data stream by identifying the trigger signal through a given slope steepness, duration and threshold of the trigger pulse. The output is an ASCII table consisting of the shot number and the shot time. Accuracy of the shot time is one of the most crucial matters in seismic wide-angle work, and must be reproduced with a precision of a few ms. Due to this demand the shot times have to be corrected with the shift of the internal recorder clock. Additionally, the trigger file contains the profile number, the start/end time of the profile and the trigger recording. The shot times are part of the ukooa file, which links them with the coordinates of the source and the hydrophones.

ukooa

The ukooa program is used to establish the geometric database by calculating the positions of sources at any given shot time and offset from the ship. The source is placed on the ship track using simple degree/meter conversions and then written to a file in UKOOA-P84/1 format. Corrections for offsets between antenna and airguns as well as consistency checks are included. This file will be used when creating a SEG-Y section via the dat2segy program. The program requires the trigger file to contain the shot times, the ship's navigation, and a Parameter file containing information for the UKOOA file header as basic input information.

dat2segy

The dat2segy program produces standard SEG-Y records either in a 16 or 32 bit integer format by cutting the single SEG-Y trace (the ref2segy output) into traces with a defined time length based on the geometry and shooting time information in the ukooa file. In addition, the user can set several parameters for controlling the output. These parameters are information about the profile and the receiver station, number of shots to be used, trace length, time offset of the trace and reduction velocity (to determine the time of the first sample within a record). Also the clock drift of the recorder (skew) is taken into account and corrected for. The final SEG-Y format consists of the file header followed by the traces. Each trace is built up by a trace header followed by the data samples. The output of the dat2segy program can be used as input for further processing with SEISMOS or Seismic Unix (SU).

relobs

Because of drifting of the OBH and OBS instruments during deployment and errors in the ship's GPS navigation system, the OBH positions may be mislocated by up to several 100 m. Since this error leads to asymmetry and incorrect traveltime information in the record section, it has to be corrected. This is accomplished with the program relobs.

For input, the assumed OBH location, shot locations and the picked traveltimes of the direct wave near to its apex are needed. To simplify the picking a static correction with a hyperbolic equation was performed to flatten the direct wave. This yields a much more coherent direct arrival which would normally suffer from strong spatial aliasing in the uncorrected section making it difficult to track. By shifting the OBH position, relobs minimizes the deviation between computed and real travel times using a least mean square fitting algorithm (assuming a constant water velocity).

Beside these main programs for the regular processing sometimes additional features are needed for special handling of the raw data:

divide

The program divide cuts the raw data stream into traces of a given length without offset and time information, storing the output in SEG-Y format. The routine is useful for a quick scan of the raw data or if a timing error has occurred.

segynhdr

The routine segynhdr prints all the header values of the raw data on the screen.

segysift

Segysift modifies the time of the first sample, allowing the whole raw data trace can be shifted by a given value. This is very useful when shifting the time base from Middle European Time to Greenwich Mean Time or any local time. Because of recording problems, the data sometimes show a constant time shift, which can be corrected as well with segysift.

mysegycut

The program mysegycut allows the user to remove out a specified time window from the raw data stream. When the shooting window is much smaller than the recording time, one can reduce the data volume by cutting out only the useful information. This will reduce the demand on disk space.

• OBH/OBS-data analysis and processing with source signals of G-guns

Raw data: As an example, a record section of the hydrophone component of OBS 905 for profile 09 is shown in Figure 5.1.3.1. in unprocessed form. Strong bubbling and double amplitudes hide some of the near seafloor reflections at short station offsets. Such signals could be recovered during data processing. Besides the shallow reflection events amplitudes of far offset reflections could be enhanced as well (Fig. 5.1.3.2).

Deconvolution analysis: To improve the temporal resolution of the seismic data a deconvolution is applied to compress the basic seismic wavelet. The recorded wavelet has many components, including the source signature, recording filter, and hydrophone/geophone response. Ideally, deconvolution should compress the wavelet components and leaving only the earth's reflectivity in the seismic trace. We applied Wiener deconvolution in successive trace segments, based on the following assumptions:

1. The earth's reflectivity is 'white'.
2. The wavelet shows the minimum-delay phase behavior.

As in this wide-angle data the amplitude spectra of the seismic traces vary with time and offset (e.g. reflected, refracted pp phases and reflected ps and ss phases), the deconvolution must be able to follow these time and offset variations. To improve especially the spatial resolution of the seismic data a multi trace deconvolution also called roll-along deconvolution which uses autocorrelograms averaged over a number of traces is tested to compress the basic seismic wavelet. Each trace is here divided into 3 s data gates with 1 s overlap, in which time invariant deconvolution operators are computed from the average autocorrelation function of 51 traces.

The operator is recalculated for every trace in each data segment and applied. The overall deconvolved trace results from a weighted merging of the independently deconvolved gates. Input for the deconvolution process is raw data. As several recordings were influenced by a DC shift, a 1-3 Hz high-pass zero phase Kaiser frequency filter with 60 dB attenuation between the pass and reject zone was applied prior to deconvolution in order to center the amplitudes around zero. The deconvolution test panels are shown in Fig. 5.1.3.3 for the near offset and Fig. 5.1.3.4 for the far offset. In the lower section of the figure the autocorrelation function is appended. Constant operator lengths of 1000 ms (predictive length excluded) and a variation of the predictive length from 2 to 80 ms is displayed for a multi trace deconvolution.

A fixed operator length of 1 sec and a prediction length of 40 ms were applied to all data sets.

Frequency filter analysis: To determine the frequencies of the seismic energy, filter panels with narrow frequency band passes for the near offset range are shown in Figure 5.1.3.5, for the far offset range in Figure 5.1.3.6. In the lower section of the figure the amplitude spectra of the corresponding filter panels are appended. The amplitude spectra of the used Ormsby frequency filter operators are characterized by linear slopes. The filter applied, which is zero phase, is described by four corner frequencies: Lower stop/pass band boundary and upper pass/stop band boundary. The frequencies on the filter panels correspond to the lower and upper pass frequencies. The main energy for the refracted phases between 4.5 and 6.5 is between 5 - 10 Hz (Fig. 5.1.3.6). For the near offset traces and for the direct wave up to 70 Hz can be observed. As a broad frequency range is contained in the data, time and offset dependent filtering was applied (see below).

Processed data: Comparison of the preprocessed data in Figure 5.1.3.2 to the unprocessed data in Figure 5.1.3.1 shows a clear reduction of the low and mono-frequency noise in the near and far offset traces and moderate compression of the wavelet signal. For the picking of events and model building by raytracing both sections were used to keep all available seismic information.

Final processing sequence

- Input: SEG-Y-data, 4 ms or 5ms sampling rate with complete geometry information.
- Tapering the first 0.5 s to zero to reduce the response of the debias filter operator.
- Kaiser highpass (debias).
- Gated Wiener deconvolution with autocorrelation average of 51 traces: gate length 3 s, overlap 1 s, length of merge region 1 s, operator length 400 ms (prediction interval excluded), prediction interval for zero offset 60 ms, for 20 km offset 120ms, and for 80 km and larger offsets 180 ms.
- Static correction to a fixed seafloor travelttime of 11 s.
- Time and offset-dependent Ormsby frequency filter.

• MCS processing

The G-gun shots were also recorded by a 4 channel mini-streamer. The group spacing is 12 m and the first offset was calculated to approximate 75 m. Due to the shot interval of 14 s (approx. 26 m) and the variable data quality, the processing sequence was adjusted for each profile after a check of the raw data.

A standard processing job was created with some variable modules, depending on the profile parameters and the data quality.

- Input: SEGY-data, 2 ms sampling rate with complete geometry information.
- Highpass (debias).
- NMO correction with 1495 m/s
- Stack
- Trace normalization
- Time dependent Ormsby frequency filter.

On time-shifted traces the following filter parameters were used:

	<u>Time interval [s]</u>	<u>lower stop/pass[Hz]</u>	<u>upper pass/stop[Hz]</u>
GI-guns:	0.0 – 1.5	10/30	170/240
	1.5 – 2.5	10/30	80/120

- Stolt migration
- Output: SEGY-data.

• Data archiving

After navigation data had been merged and SEGY formatted traces with the appropriate header words had been created, the data were also archived. Finally, a third set was stored and archived after the shipboard processing, as described above, had been applied. All final processed SEGY data were archived on mobile disk drives

• Data exchange

The raw segy data is in Integer2 format whereas the processed data is stored in IBM-floating point.

This is the definition of the segy trace header for the IFM-GEOMAR OBS wide-angle reflection data. The extension of the standard SEGY header from 181 to 240 byte is a layout in order to process the data on the SEISMOS software system. Reading bytes directly into this header will allow access to all of the fields.

<u>BytePos</u>	<u>Bytes</u>	<u>Information</u>	<u>Comments (note: not all headers available in processed data)</u>
1-8	(2x4)	lineSeq, reelSeq;	/* Sequence numbers within line and reel, resp.*/ /* here station and shot number Def: 1, 1 */
9-12	(4)	profNumber;	/* Original field record number */ /* Here profile number */
13-16	(4)	traceNumber;	/* Trace number within the original field record.*/ /* Here station (receiver) Number */
17-20	(4)	energySourcePt;	/* Energy source (shot) point numbe */ /* Def: 0 */
21-24	(4)	cdpEns;	/* CDP ensemble number: shot number */ /* Def: 0 */
25-28	(4)	traceInEnsemble;	/* Trace number within CDP ensemble */ /* Here azimuth in seconds of arc for unprocessed data*/
29-30	(2)	traceID;	/* Trace identification code: 1=seismic data (Def) 4=time break 7=timing, 2=dead, 5=uphole, 8=water break, 3=dummy, 6=sweep, 9..., optional use */

31-34	(2x2)	vertSum, horSum;	/* Def: 1, 1 */
35-36	(2)	dataUse;	/* 1=production (Def), 2=test */
37-40	(4)	sourceToRecDist;	/* Distance in (m) */
41-44	(4)	recElevation;	/* Elevation in (m), Def: 0 */
45-48	(4)	sourceSurfaceElevation;	/* Def: 0 (m) */
49-52	(4)	sourceDepth;	/* Def: 0 (m) */
53-60	(2x4)	datumElevRec, datumElemSource;	/* Def: 0, 0 (m) */
61-68	(2x4)	sourceWaterDepth, recWaterDepth;	/* Def: 0, 0 (m) */
69-70	(2)	elevationScale;	/* Scale elevations Def: 0 (10**0) */
71-72	(2)	coordScale;	/* Scale coordinates Def: -2, means coordinates multiplied by 10**(-2) to get real value for unprocessed data. NOTE: for processed data -100 means to divide by 100 to get the real value */
73-80	(2x4)	sourceLongOrX, sourceLatOrY;	/* Either Cartesian or geographic */
81-88	(2x4)	recLongOrX, recLatOrY;	
89-90	(2)	coordUnits;	/* 1= meter or feet; 2=sec of arc */
91-92	(2)	weatheringVelocity;	/* Def: 0 (m/s) */
93-94	(2)	subWeatheringVelocity;	/* Reduction velocity, Def: 6000 (m/s) */
95-96	(2)	sourceUpholeTime;	/* Def: 0 (ms) */
97-98	(2)	recUpholeTime;	/* Def: 0 (ms) */
99-102	(2x2)	sourceStaticCor, recStaticCor;	/* Def: 0, 0 (ms) */
103-104	(2)	totalStatic;	/* Def: 0 (ms) */
105-106	(2)	lagTimeA;	/* T(shottime) - T(first sample) */
107-108	(2)	lagTimeB;	/* Def: 0 (ms) */
109-110	(2)	delay;	/* Def: 0 (ms) */
111-114	(2x2)	muteStart, muteEnd;	/* Def: 0, 0 (ms) */
115-116	(2)	sampleLength;	/* Number of samples in this trace */ /* (> 32767)? = 32767 set long samp_rate in 185-188 byte */
117-118	(2)	deltaSample;	/* Sampling interval in microseconds. */
119-120	(2)	gainType;	/* 1=fixed (Def), 2=binary, 3=floating, 4... opt.*/
121-122	(2)	gainConst;	/* Gain of recording channel */
123-124	(2)	initialGain;	/* Gain of preamplifier in db */
125-126	(2)	correlated;	/* 1=no (Def), 2=yes */
127-130	(2x2)	sweepStart, sweepEnd;	/* min. and max. amplitude of trace */
131-132	(2)	sweepLength;	/* Here defined as fraction of second of shot time */
133-134	(29)	sweepType;	/* Source type: 1=linear, 2=parabolic, 3=exponential, 4=others, 5=bohrhole explosive, 6=water explosive, 7=airgun (Def) or fraction of microsecond of shot time for high resolution data */
135-138	(2x2)	sweepTaperAtStart, sweepTaperAtEnd;	/* Start and end of trace (ms) relative to Tred(0) */
139-140	(2)	taperType;	/* scaling factor for last two values Def: 1 (x10) */
141-144	(2x2)	aliasFreq, aliasSlope;	/* Def: 0, 0 */
145-148	(2x2)	notchFreq, notchSlope;	/* Def: 0, 0 */
149-152	(2x2)	lowCutFreq, hiCutFreq;	/* Def: 0, 0 */
153-156	(2x2)	lowCutSlope, hiCutSlope;	/* Def: 0, 0 */

157-166 (5x2)	year, day, hour, minute, second;	/* Source (shot) time, the fraction of sec */ /* is set in millisecc between 131-132 byte is set in microsec between 133-134 */
167-168 (2)	timeBasisCode;	/* 1=local, 2=GMT, 3=MET (GMT + 1 hour) (Def) */
169-170 (2)	traceWeightingFactor;	/* */
171-172	(2) phoneRollPos1;	/* Component: 1=time code, 2=radial, 3=transverse, 4=vertical, 5=hydrophone (Def) */
173-174 (2)	phoneFirstTrace;	/* Methusalem instrument number in YYNN */
175-176 (2)	phoneLastTrace;	/* Channel number */
177-178 (2)	gapSize;	/* Source charge in cubic inches (airgun) or kg (explosives) */
179-180 (2)	taperOvertravel;	/* Def: 0=meaningless 1=up, 2=down */ /* !!! Following is extension !!! */
181-182 (2)	compNo;	/* 1=time code, 2=radial, 3=transverse, 4=vertical, 5=hydrophone (Def) */
183-184 (2)	samplingRate;	/* samples/sec */
185-188 (4)	numberSamples;	/* (<= 32767) ? sampleLength (> 32767) */
189-190 (2)	shotPointNo;	
191-192 (2)	ADCoeff;	/* Coefficient of A/D converter in mv/digit */
193-194 (2)	receiverCoeff;	/* Conversion coefficient of receiver, pascal/cm2 for hydrophone, velocity(m/s)/volt for geophone */
195-196 (2)	receiverType;	/* 1=hydrophone (Def), 2=geophone, 3... */
197-200 (4)	lengthData;	/* Def: 0 (ms), not used here */
201-204 (4)	distance;	/* Source to receiver distance in (m) */
205-208	(4) (float) scaleFactor;	/* Scale factor same as in <segy.h> Here azimuth in second of arc for processed data */
209-210 (2)	azimuth;	/* Orientation of the component in min */
211-212 (2)	eigenperiod;	/* Eigenperiod of geo- or hydrophone in (ms) */
213-216 (4)	minAmpl;	/* Min. peak amplitude within trace */
217-220 (4)	maxAmpl;	/* Max. peak amplitude within trace */
221-222 (2)	stationNo;	/* Station number */
223-224 (2)	channelNo;	/* Channel number (Default: 1) */
225-228 (4)	sourceCharge;	/* Charge in kg (explosive) or cc (airgun) */
229-230 (2)	redVelocity;	/* reduction velocity in (m/s); Def: 0 if no reduction velocity se */
231-232 (2)	timeOffset;	/* Time offset in (ms) of first sample relative to reduced source time: positive if earlier than reduced time */
233-236 (4)	redTime;	/* Reduced time in (ms) = distance/redVel */
237-238 (2)	unused2;	
239-240 (2)	instNo;	/* Methusalem instrument number */

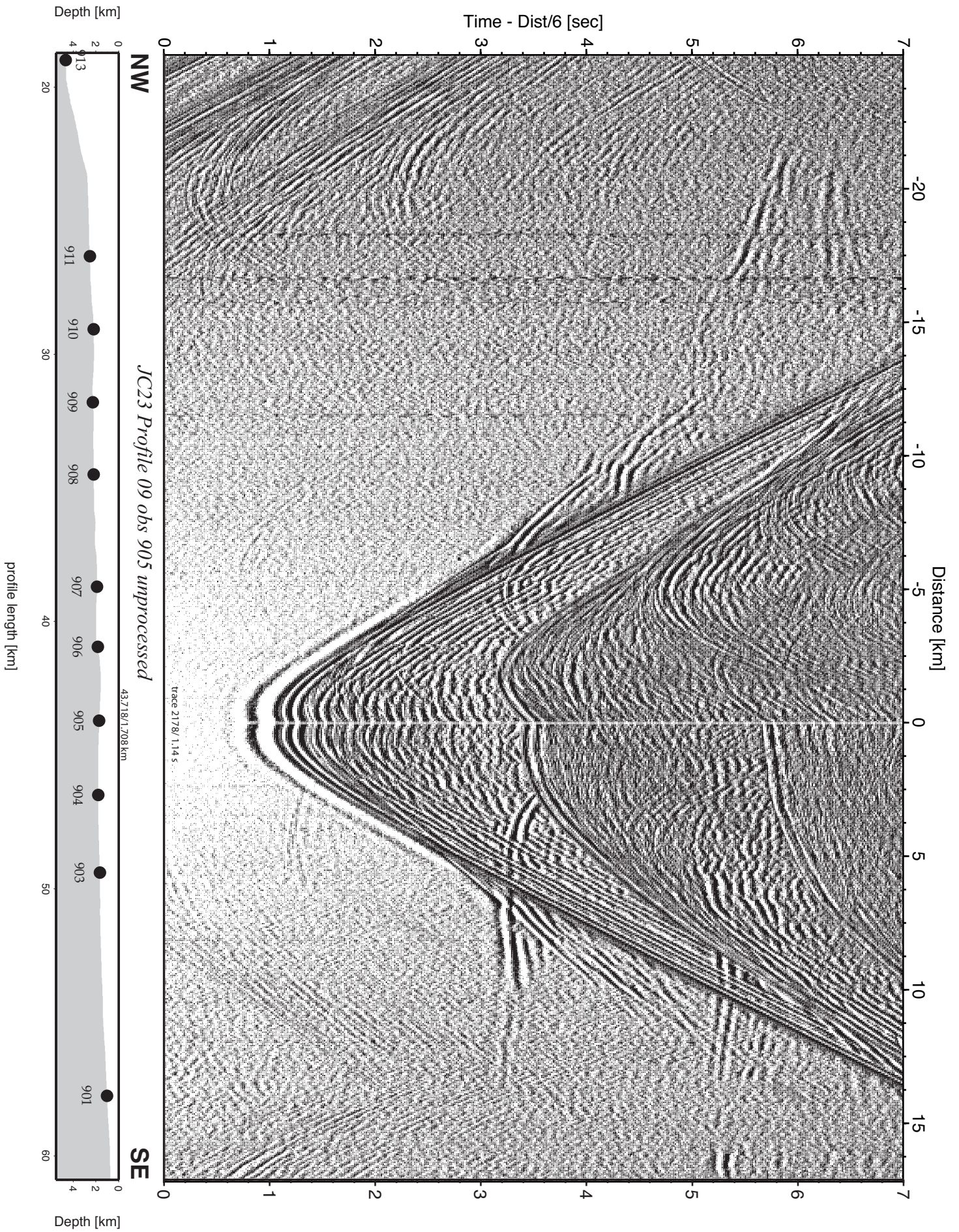

Figure 5.1.3.1 : Record section from obs 905 unprocessed, Profile 09.

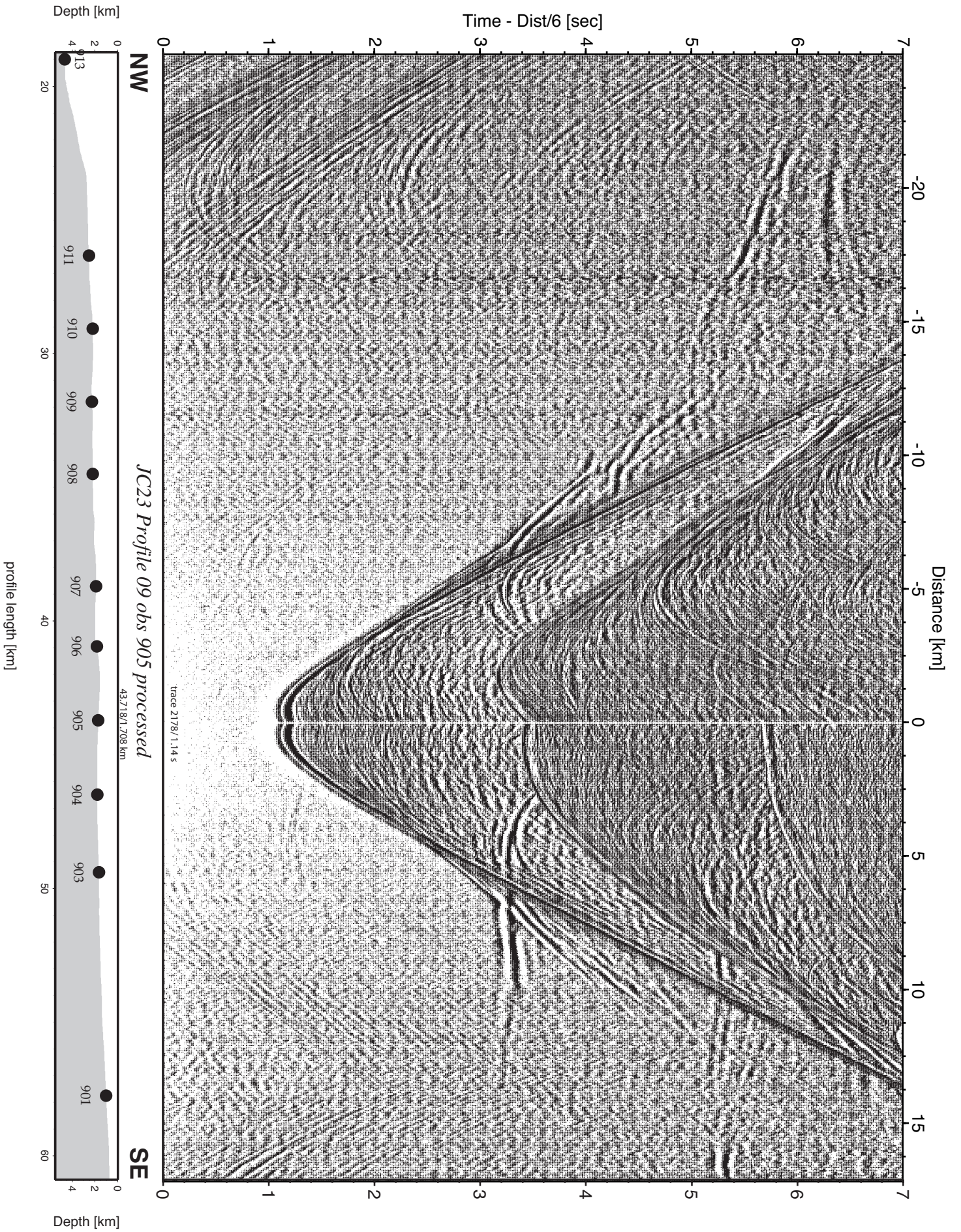

Figure 5.1.3.2 : Record section from obs 905 processed, Profile 09.

JC23 Profile 09 obs 905 hydrophone component

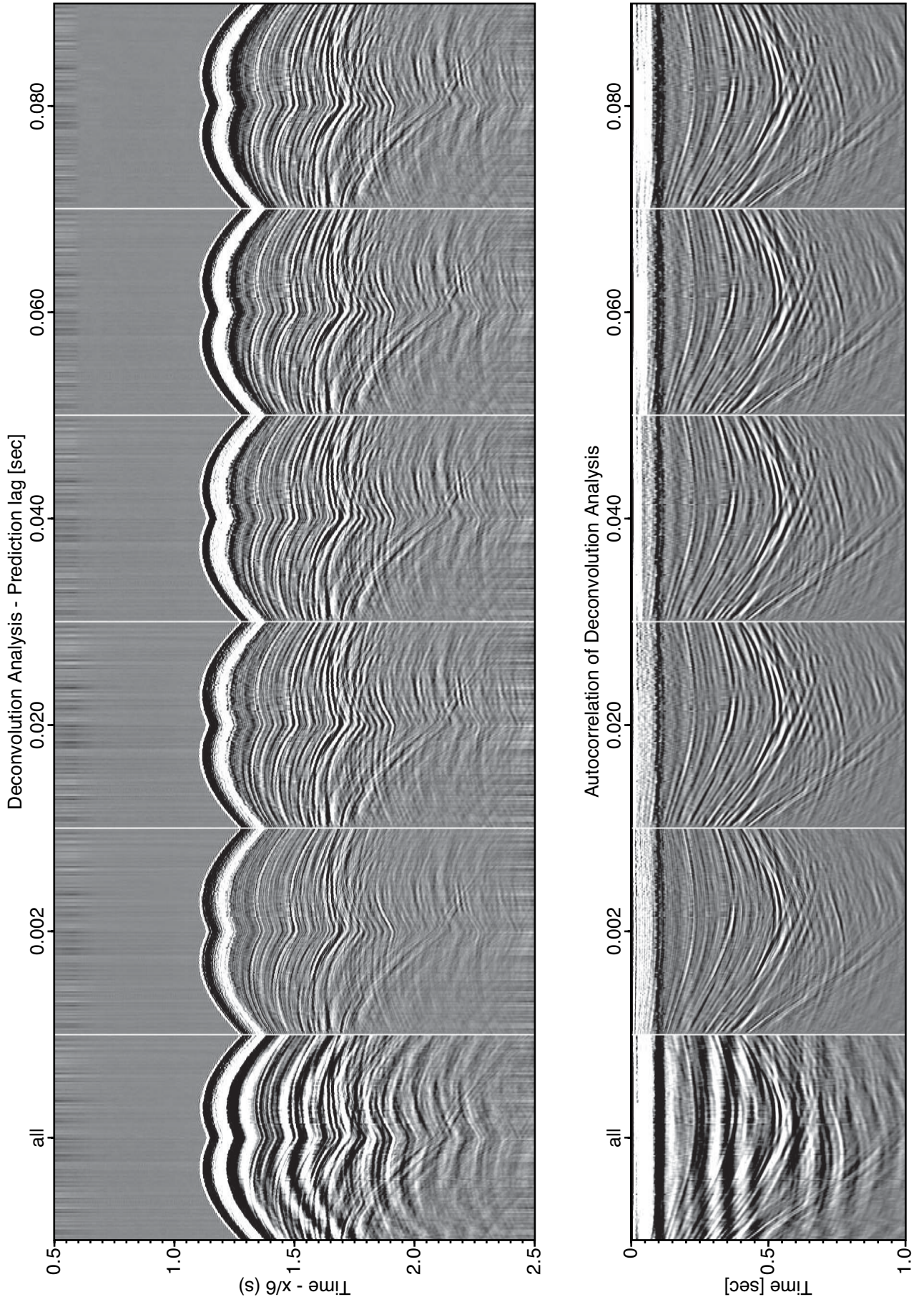

Figure 5.1.3.3:deconvolution analysis in far offset ranges.

JC23 Profile 09 obs 905 hydrophone component

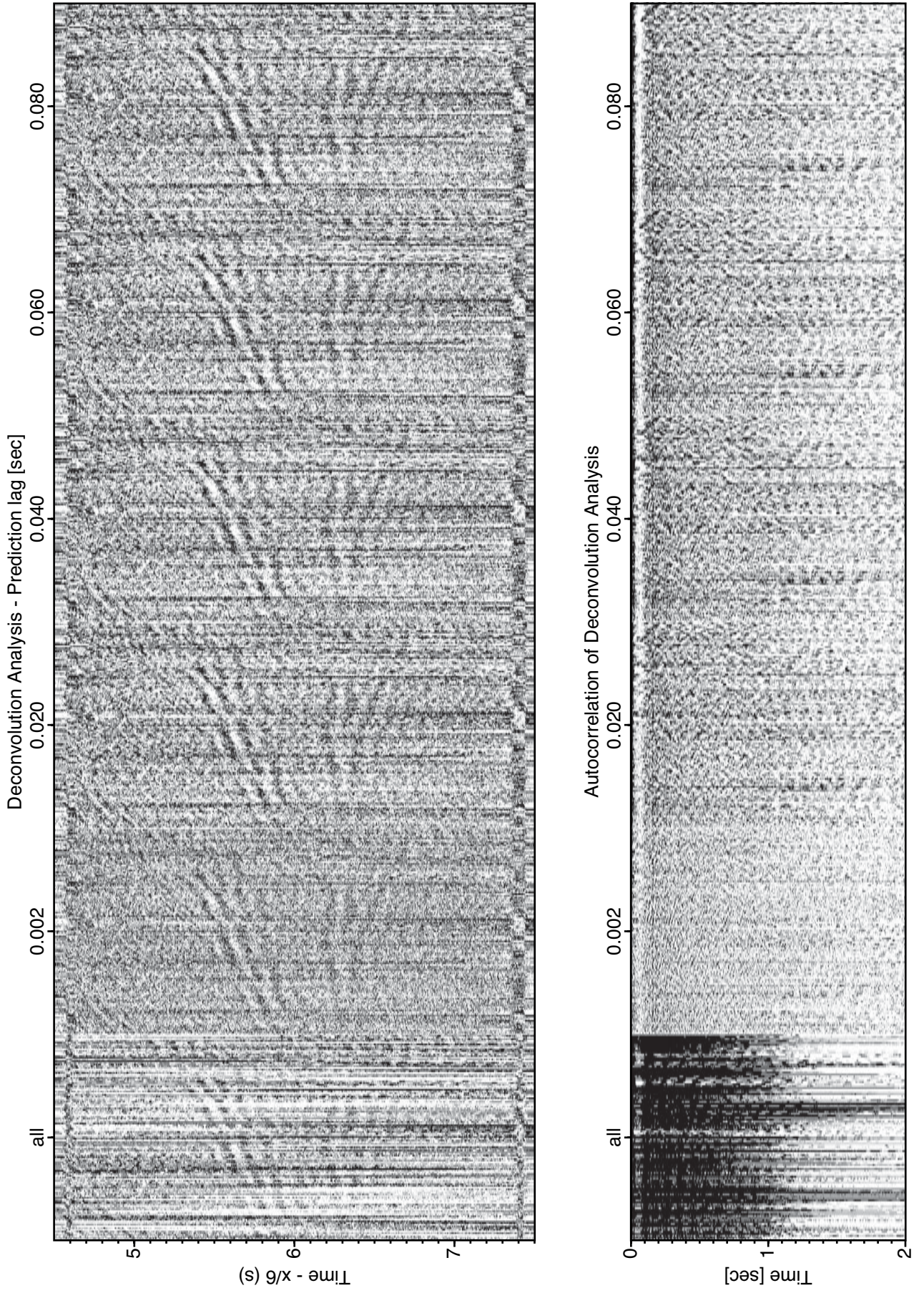

Figure 5.1.3.4:deconvolution analysis in far offset ranges.

JC23 Profile 09 obs 905 hydrophone component

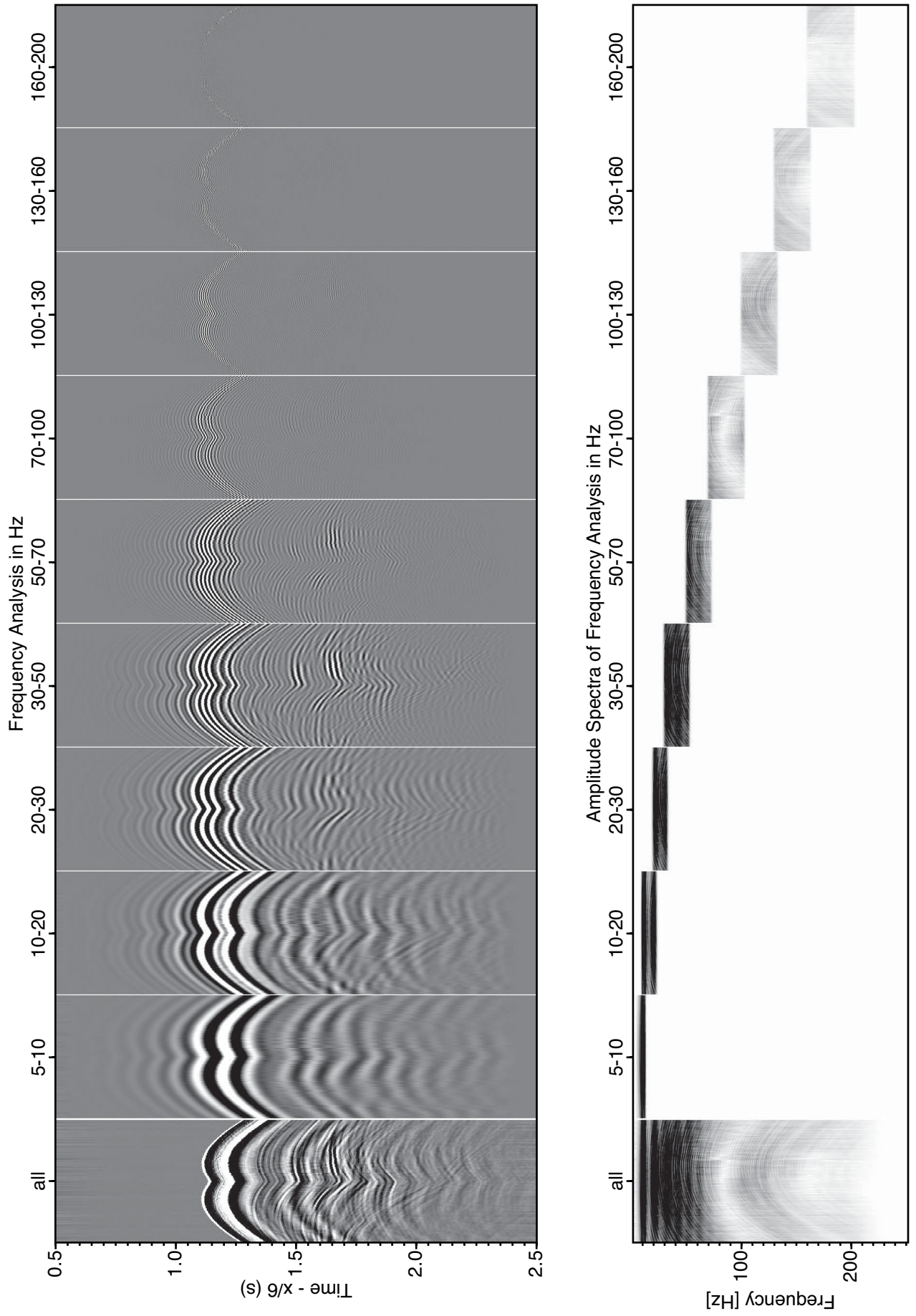

Figure 5.1.3.5: Frequency analysis in near offset ranges.

JC23 Profile 09 obs 905 hydrophone component

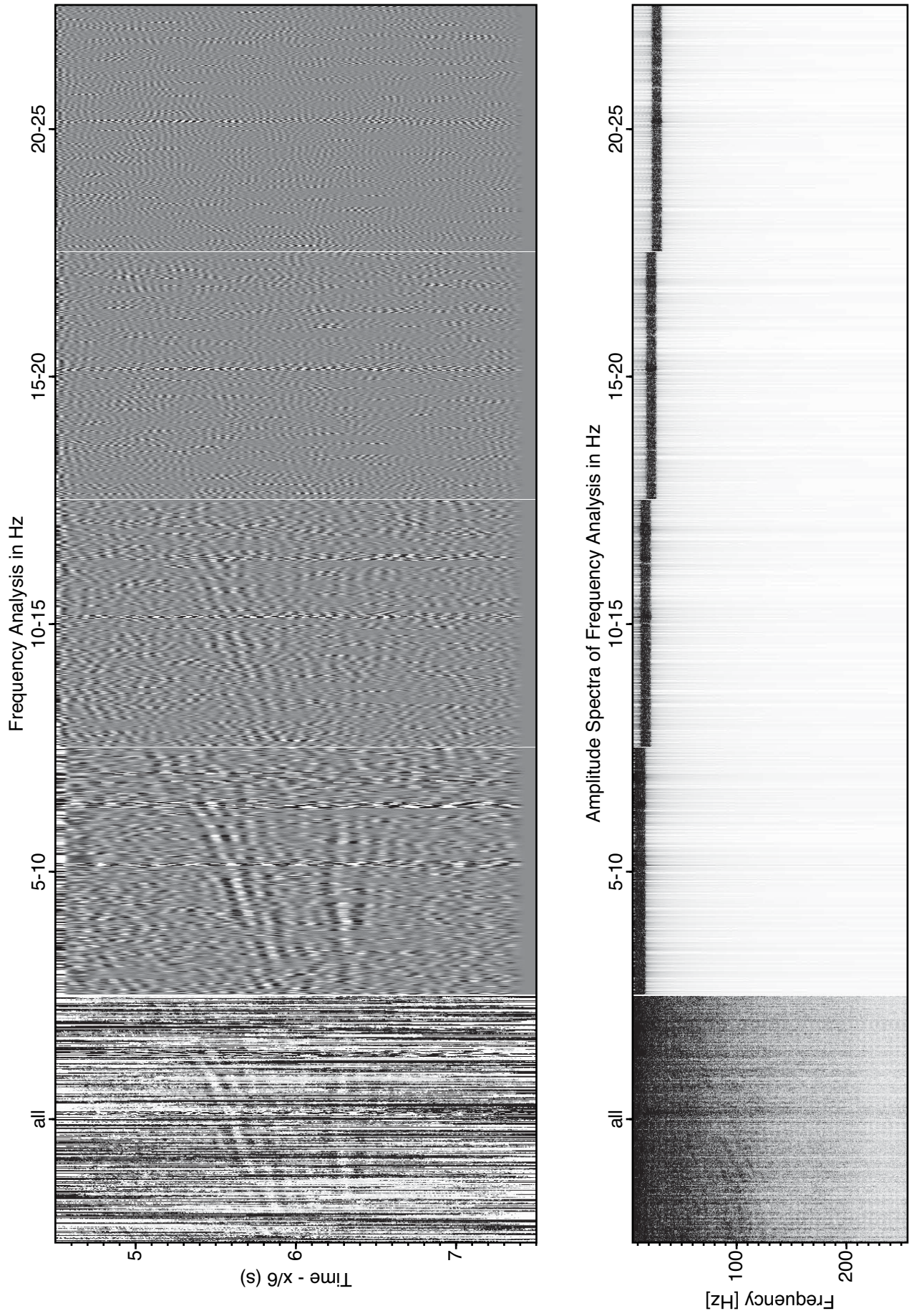

Figure 5.1.3.6:Frequency analysis in far offset ranges.

5.2 Seismic profiles

5.2.1 Profiles 1 and 11

The entire profile 1 covers 29 seismic instruments with a spacing of 3.5 km and crosses the Chile Trench and margin from west to east at 35° S. The profile is extended by 5 land stations installed during the first week of March. OBH's 108 to 111 had additional methane sensors. A location map is shown in Figure 5.2.1.1.

The deployment of the OBH/S was finished on 07.03. and shooting started in the morning of the 08.03. The time between last instrument deployment and airgun deployment was used to collect new bathymetric data. At 8 o'clock the airgun array had been deployed and after the beginning of the mammal watch the shooting started with a softstart at 8:41 am. and lasted for 33 h with a shot interval of 60 s and a ship velocity of 4 kn. The shooting had to be interrupted once due to seals around the ship and stopped for 33 min. During shooting several guns have been offline for a while to fix occurred technical problems.

The recovery of all seismic stations was successful. Four stations will be recovered in April 2008 as part of the short term seismological network and one station stays until November 2008, as node of the long term network registering seismic events from the seismogenic zone.

A four channel streamer and a magnetometer have been deployed as well. An OBS/H data example is shown in Figure 5.2.1.2. In general the seismic data are of very good quality with clear crustal and mantle arrivals and a signal penetration of several tens kilometers. The plate boundary reflection is clearly imaged on several sections.

Profile 11 was a 18 km long profile shot parallel to the Chilean coast and the trench. No further instruments had been deployed, so only fan recording was made in a shoot interval of 40 s and a ship velocity of 5 kn. The intersecting point to P01 is OBH102.

Plots of the methane sensors and the magnetometer can be found in chapter 6. and in Figure 12.2 respectively. Details on the instrumentation and the shooting protocol can be found in the Appendices 15.1 and 15.2.

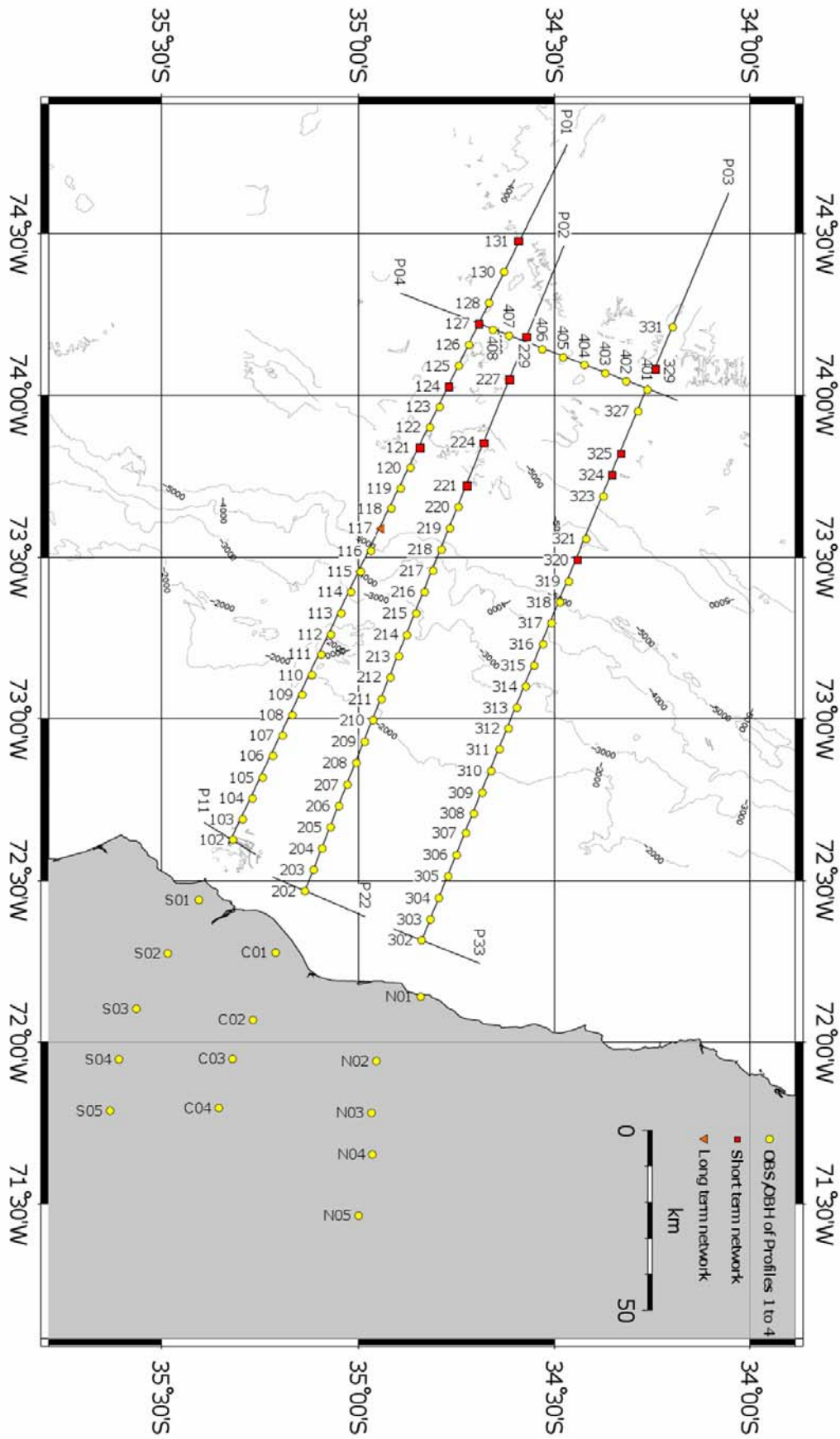

Figure 5.2.1.1: Location map of JC23-A wide-angle profiles p01 to p04

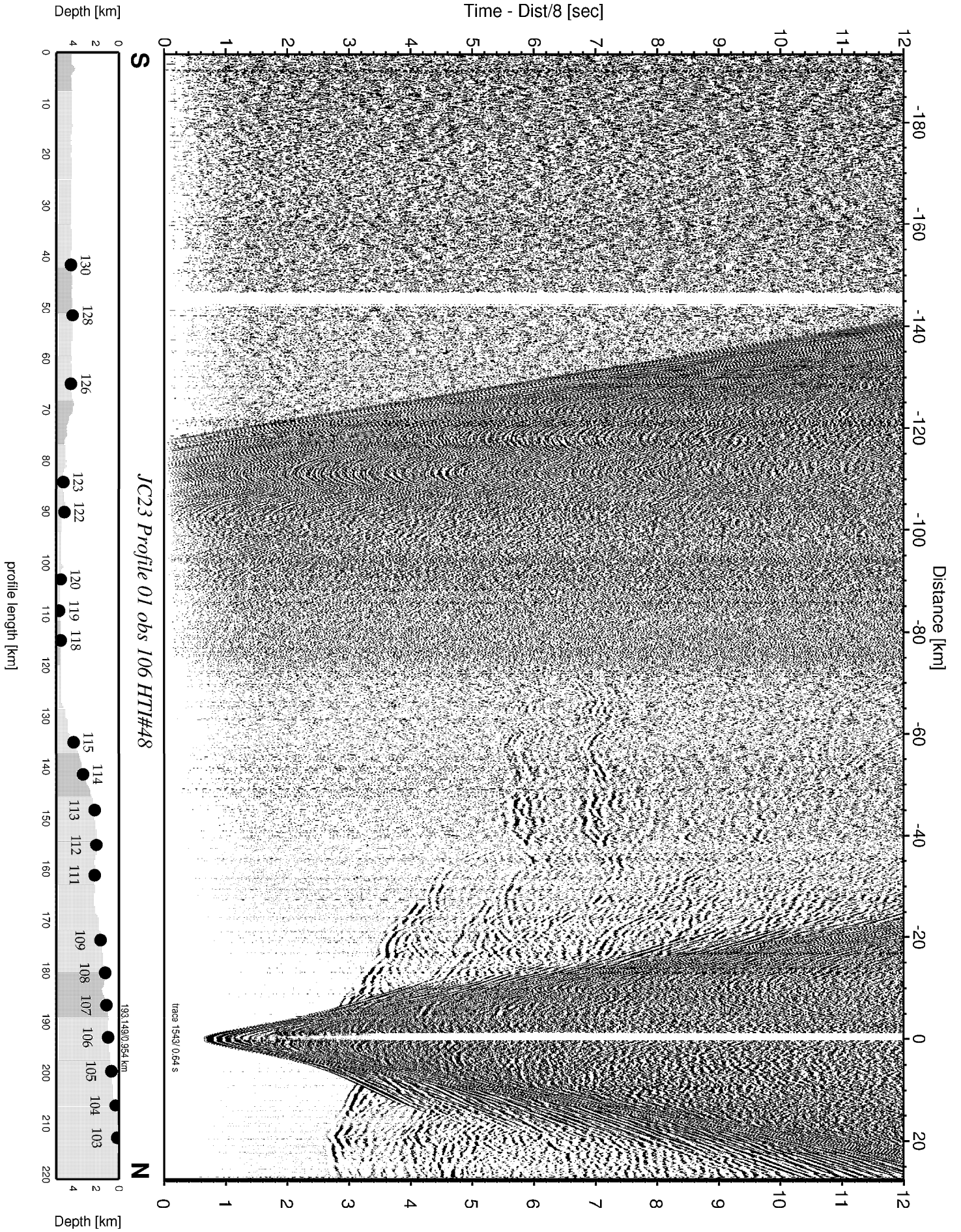

Figure 5.2.1.2: Data example from obs 106

5.2.2 Profiles 2 and 22

Profile 2 (Figure 5.2.1.1) crosses from west to east the Chile Trench and the margin. A total of 24 instruments were deployed on 17./18.03., but shooting started at 12:21 on 19th of March and terminated at 13:48 on 20th of March. The shoot was done without any interruption in an interval of 60 s resulting in a 197 km long line. But after 15 hours of shooting the Bolt gun had to be switched off at 4:34 the 20.03. and stayed on deck for the second half of profile 2 and the entire profile 22 due to bad weather conditions. The instrument spacing was 3.5 nm. The 4-channel streamer was also deployed and towed in two meter depth. OBH 209 to 212 have had additional methane sensors.

The recovery of all instruments was completed on 21.03. apart from the stations of the Outer Rise Network that register seismic events at a recording frequency of 100 Hz and will be recovered in April 2008. On land the profile 2 is extended by four seismometers.

The seismic data that have been collected are of good quality and especially in the deeper part of the profile of very good quality. In the seismic sections crustal and mantle phases of both the subducting oceanic plate and the continental plate appear also at larger offsets of several tens and as far as 100 km.

OBH/S data examples can be found in Figures 5.2.2.1 and 5.2.2.2. Results of the methane sensors and the magnetometer are shown in chapter 6. and in figure 12.3. The details on instrumentation and the airgun shots are given in the Appendices 15.1 to 15.2

Profile 22 was shot parallel to the Chilean coast in a shot interval of 40 s. The shooting on 20.03. started at 15:42 and stopped at 19:31 without any interruption. P22 crosses profile 2 at station 202.

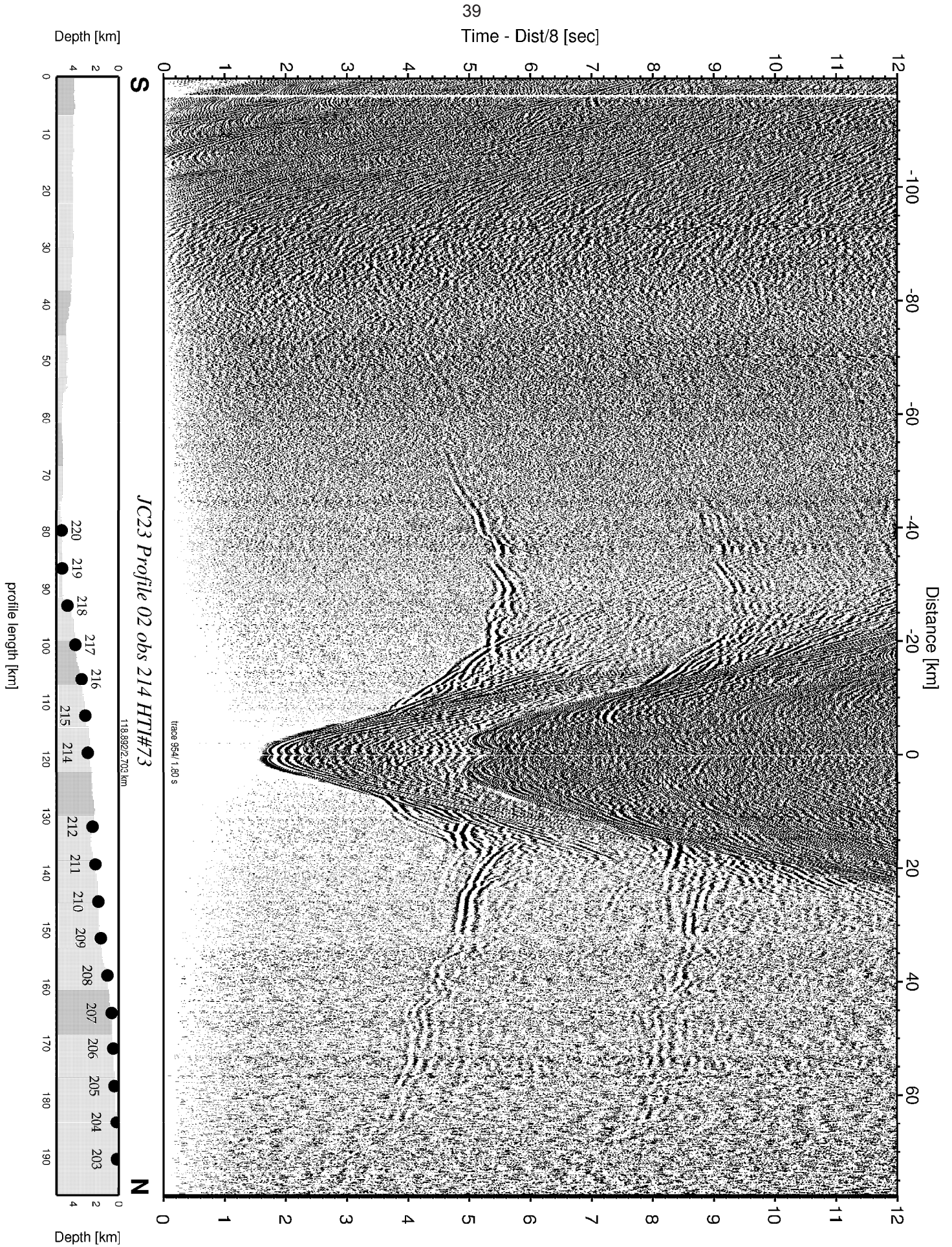

Figure 5.2.2.1: Data example from obs 214

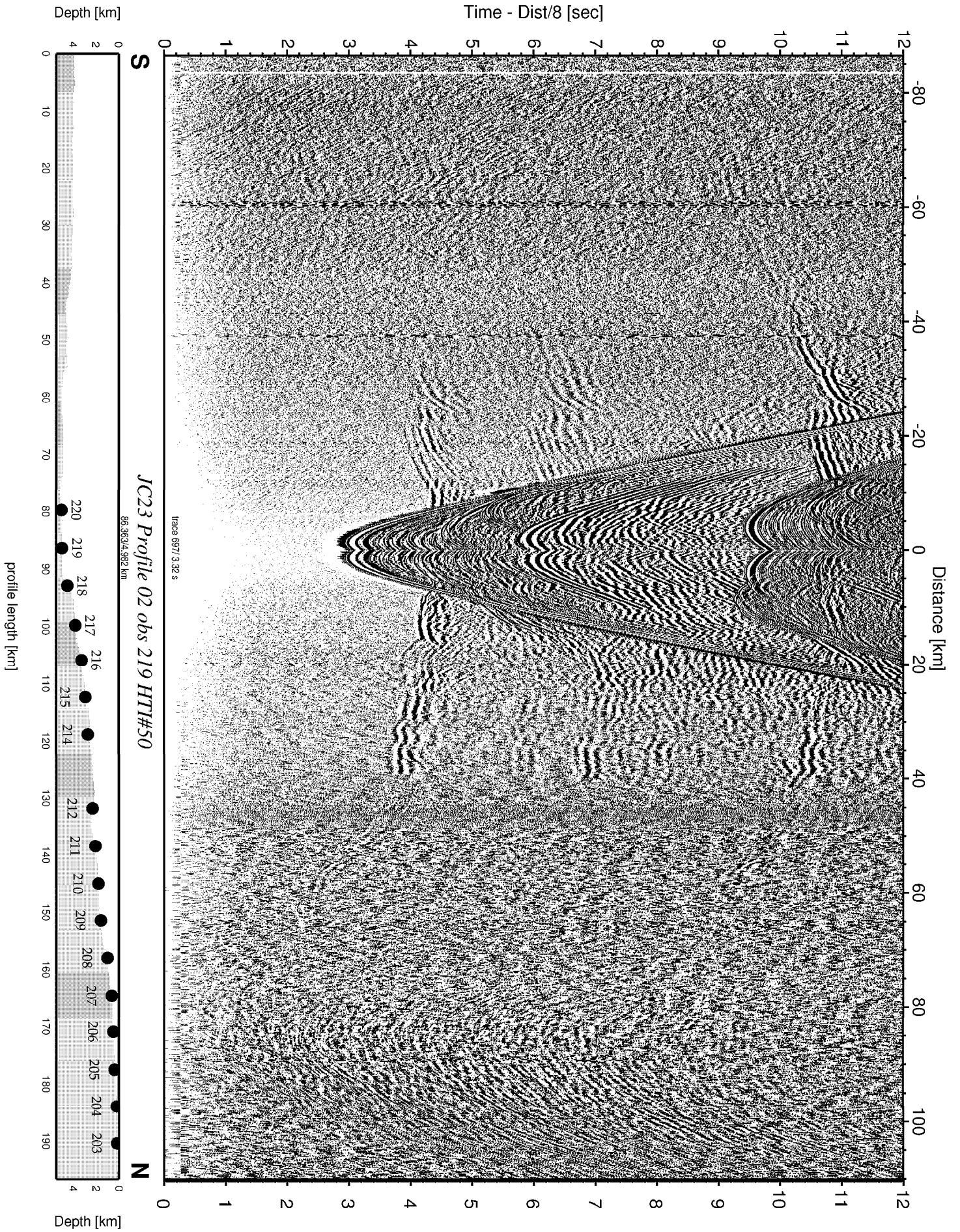

Figure 5.2.2.2: Data example from obs 219

5.2.3 Profiles 3 and 33

Profiles 3 and 33 are the northern most wide-angle seismic profiles of the investigated area. Crossing the Chile Trench and the margin from west to east at 34° N P03 includes 26 OBH/S. Additionally five land stations continue the profile towards the east and four OBH were equipped with methane sensors. Altogether nine MT stations were also deployed along the line. Profile 33 intersects the west-east profile at station 302 from north to south parallel to the Chilean coast (Location map in Figure 5.2.1.1).

The shooting at 60 s interval for profile 3 started at 11:46 March the 13th and lasted for 30.5 hours, resulting in a 230 km long line. For fan shooting profile 3 was shot with an interval of 40 s and 5 kn on 20th of March from 19:15 to 22:05. All guns worked without failure through the entire time.

The recovery of all seismic stations was successful, except for four OBS that remained on the oceanic plate until April 2008 as part of the short term seismological network.

The four channel streamer and a magnetometer have been deployed as well. In general the seismic data are of similar good quality like P01 with clear crustal and mantle arrivals and a signal penetration of several tens kilometers, exceeding 140 km in places.

Plots of the methane sensors and the magnetometer can be found in chapter 6. and Figure 12.4. respectively. Details on the instrumentation and the shooting protocol can be found in the Appendices 15.1 and 15.2

5.2.4 Profile 4

An additional profile could be performed that is aligned parallel to the trench on the oceanic plate to better resolve the oceanic crust. The deployment of eight instruments was done on 15th of March 2008 and shooting took place from 7:40 to 16:50 on 16.03. with a 60 s shot interval. This results in a profile length of approx. 85 km from north to south. Two OBS of the Outer Rise Network (127 and 229) are almost aligned in line with stations 401 – 408 (Fig: 5.2.1.1)

After the recovery of all eight OBS/H it turned out that the obtained data are of excellent quality. Even converted shear waves with mantle arrivals are visible in the seismic sections of the hydrophones. The offset with clear arrivals is only limited in the profile length. Thus crust and upper mantle have been penetrated sufficiently.

The four channel streamer and the magnetometer have been deployed during shooting. Plots of the seismic sections can be found in Figures 5.2.4.1 and 5.2.4.2 respectively. Details on the instrumentation and the shooting protocol can be found in the Appendices 15.1 and 15.2.

A first interpretation was attempted onboard. A diagram of all arrivals picked is shown in Figure 5.2.4.3. It is rather obvious that the travel times are slightly asymmetric, due to changing water depth and local disturbances caused by ridges and seamounts, that are also apparent on the bathymetric chart. Modeling the travel times, as shown in Figure 5.2.4.4 for OBS 408 with the resulting model in Figure 5.2.4.5 indicates that there seems to be a thin (200 plus/minus 100m) sedimentary cover, the velocity of which cannot be resolved. The oceanic crust is 6.0 to 6,5 km thick, with a high velocity gradient in the upper two km (4.4 to 6.2 km/s), underlain by a 4 km thick lower oceanic crust with velocities not exceeding 6.8 km/s. The Moho is a very sharp boundary, as evidenced by the strong PMP reflections seen on all record sections. The mantle velocities are normal with 8.0 to 8.1 km/s.

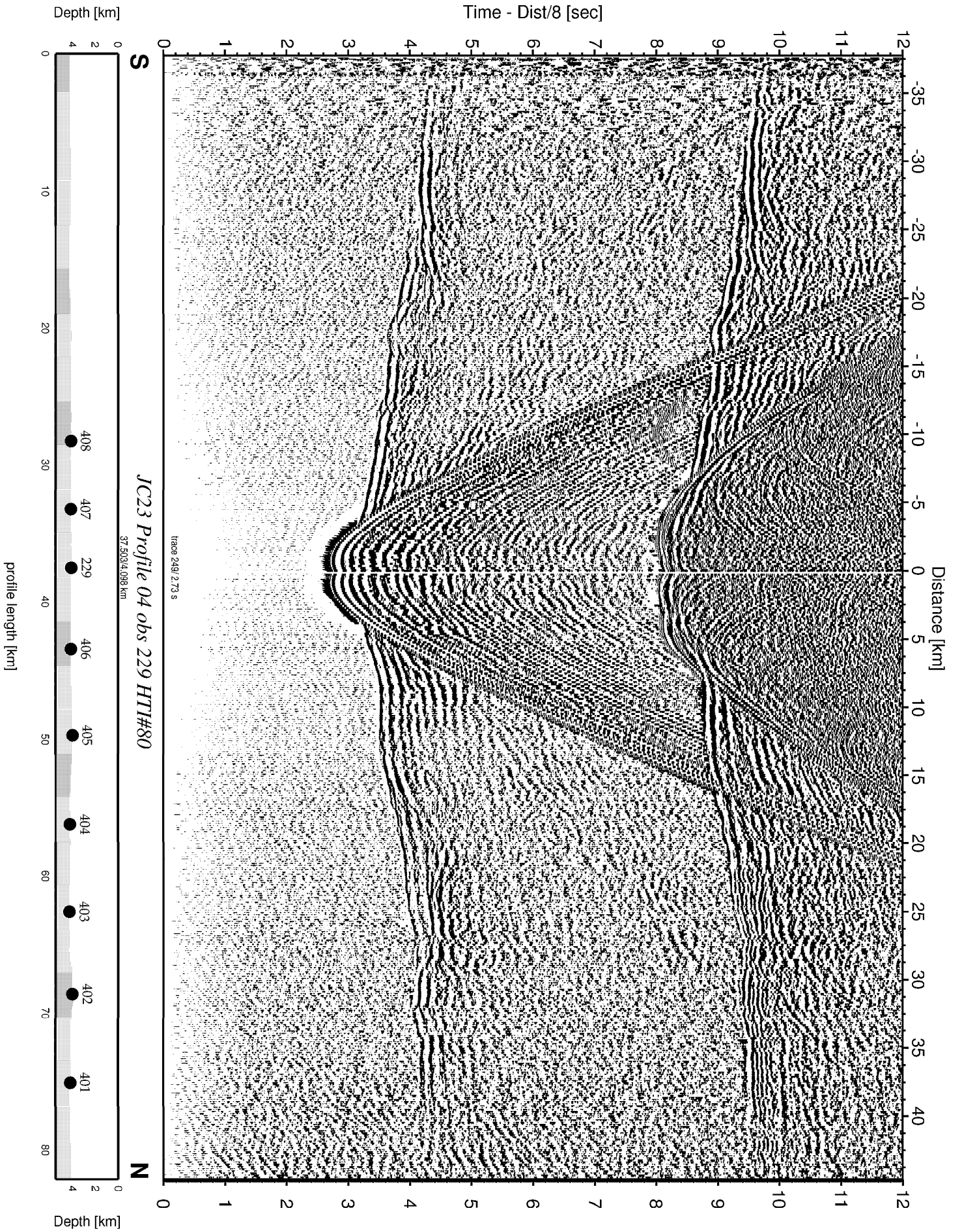

Figure 5.2.4.1: Data example from obs 229

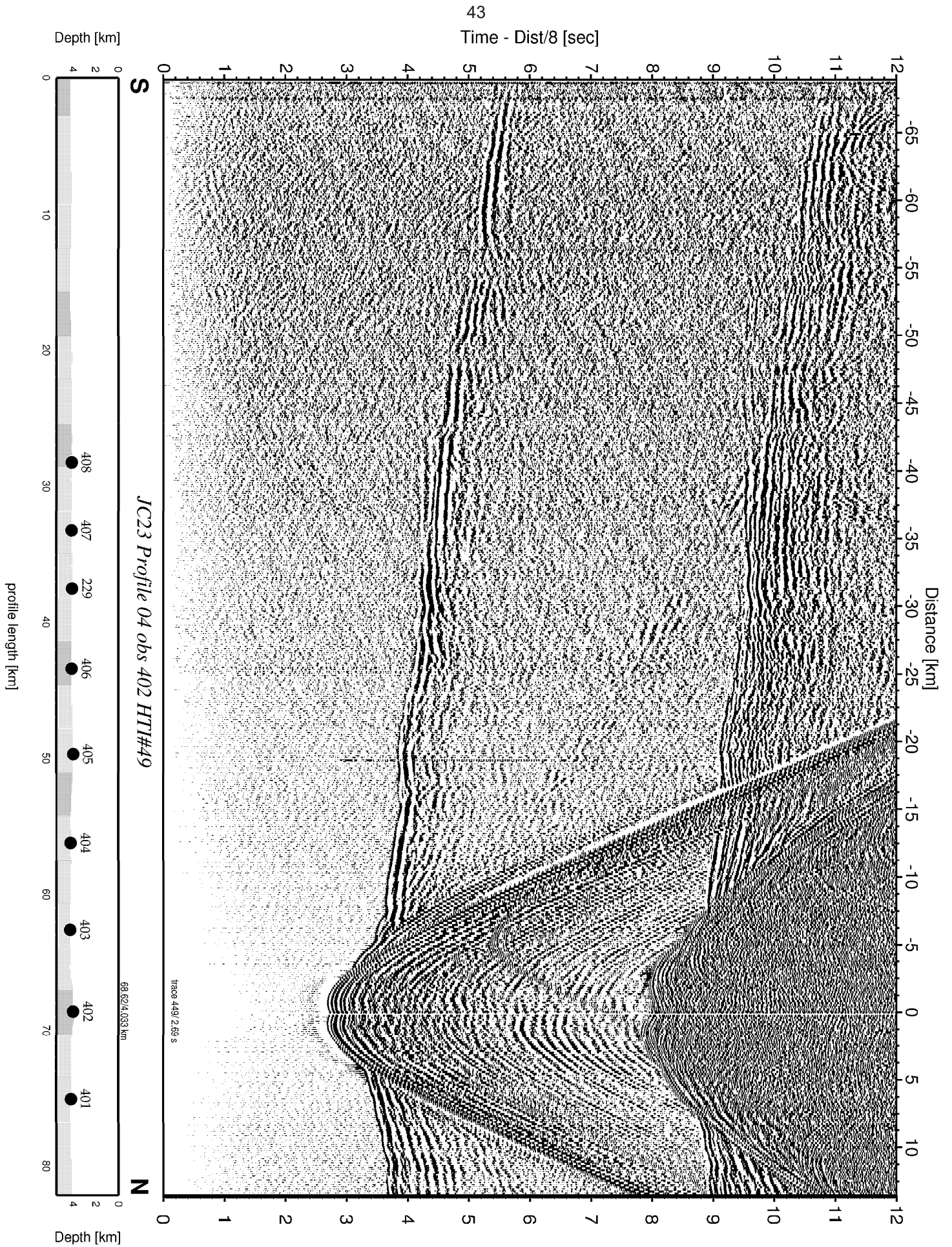

Figure 5.2.4.2: Data example from obs 402

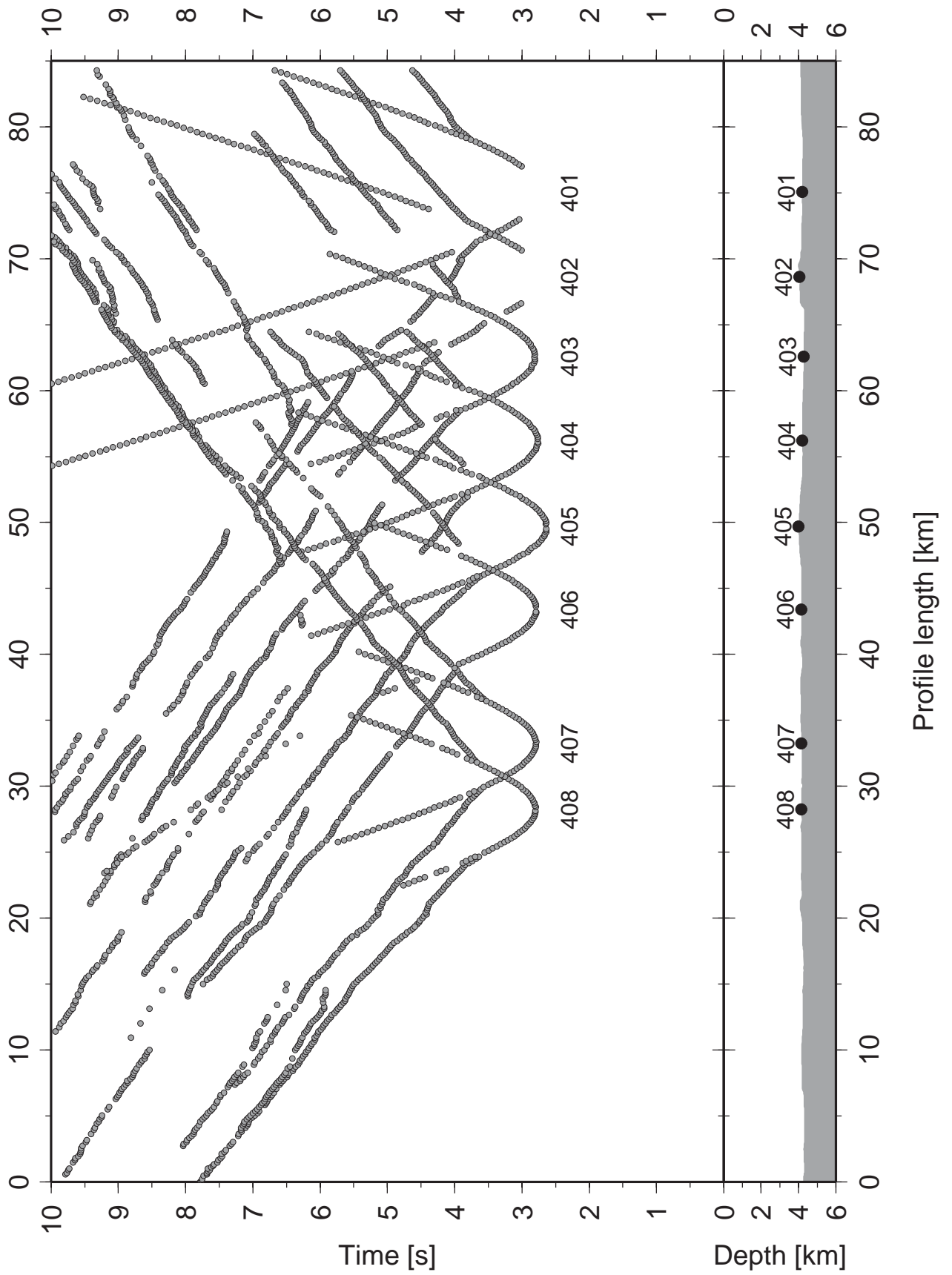

Figure 5.2.4.3: picked onsets of the OBSs on profile p04.

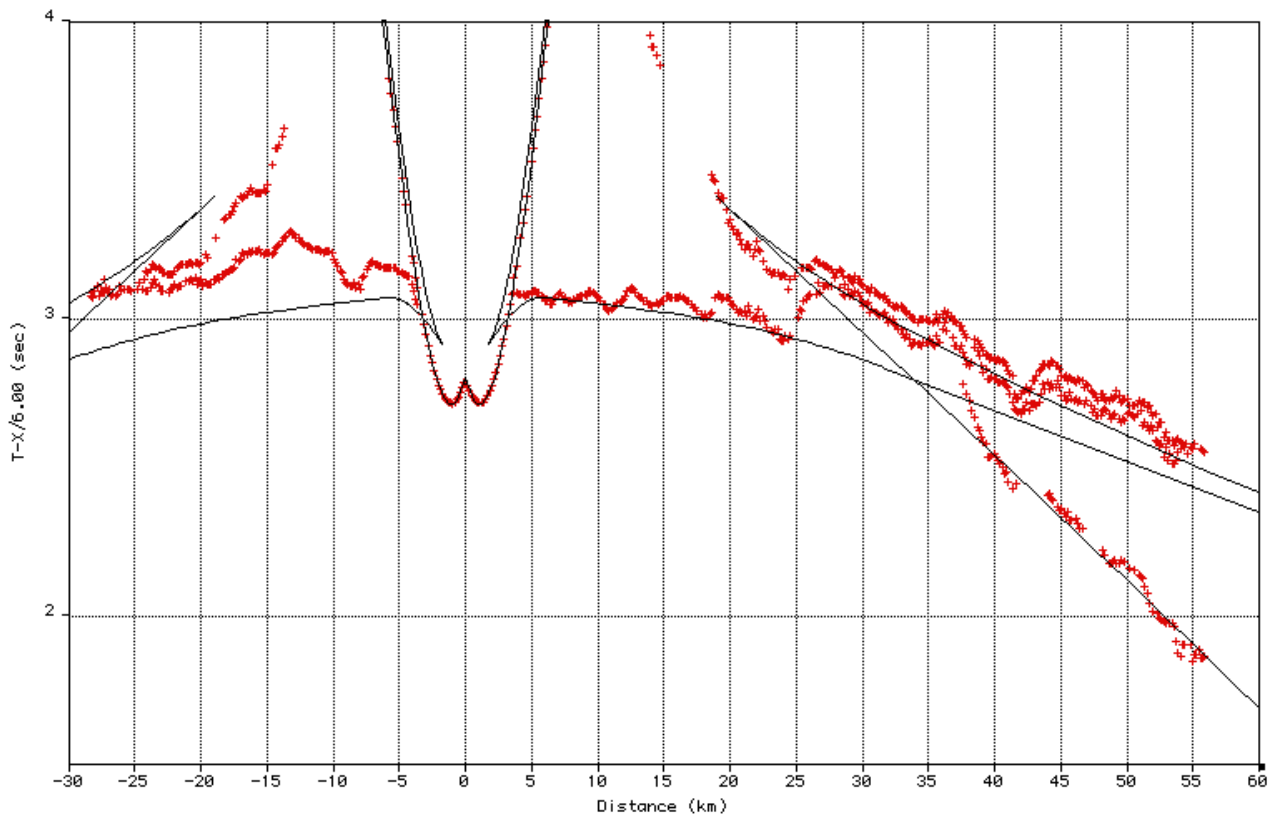

Figure 5.2.4.4: *Travel time picks and calculated travel times for a homogeneous Earth model for OBS 408. Note the apparent asymmetry of the travel times, caused by differences in water depth along the profile.*

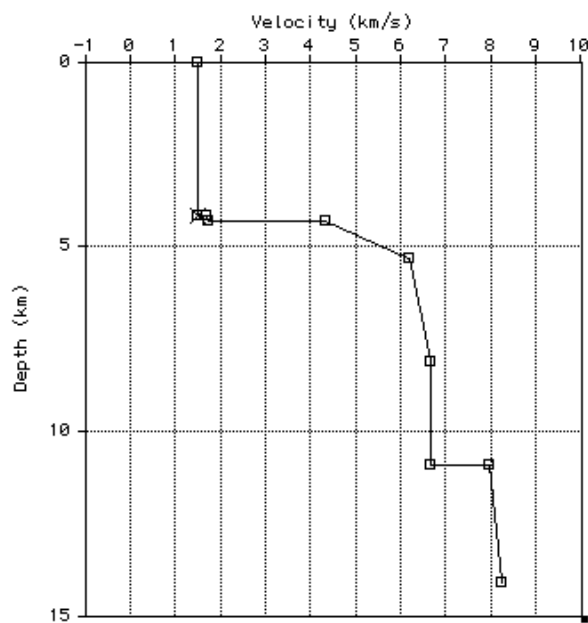

Figure 5.2.4.5: *Velocity model used to calculate traveltimes as shown in Figure 5.2.4.4.*

5.2.5 Profiles 08 and 81

The line is aligned north to south at approx. $72:30^{\circ}$ W on the margin at about 1500 m of waterdepth (A location map is shown in Figure 5.2.5.1) and was deployed for test purposes. Previously, methane plumes had been reported from this area (Juan Diaz, pers. Comm.). A tiltmeter and three instruments with one or two methane sensors were deployed at about 0.2 nm spacing. Three OBS (805, 806 and 807) were spaced 1 nm apart. The shooting along the profile took place on 23.03. with two different airgun systems. Shooting from north to south was done with two IFM-Geomar GI-guns, the shooting interval was set to 13 sec, the guns were towed at 5 m. In the opposite direction (P81) one of the four subarrays with three guns was shot at 30 sec intervals. The four channel streamer was also deployed. The airgun instrumentation is described in chapter 5.1.2.

The three OBS were recovered during the same day while the methane sensors and tiltmeter stayed on the ground until 28/03/08.

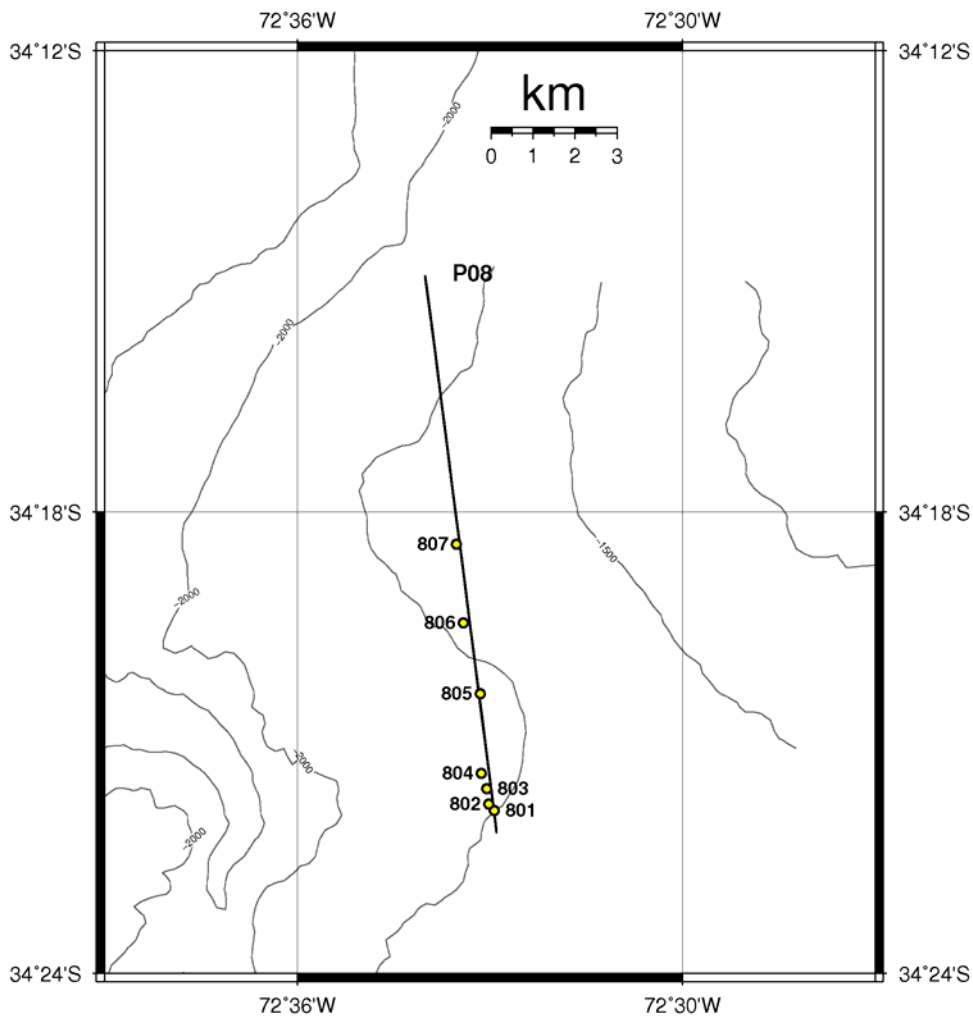

Figure 5.2.5.1: Location map of Profile 08

5.2.6 Profile P09

Profile P09 covers the continental slope at 35°39' S (Fig. 5.2.6.1). 19 OBS were deployed along the line (example sections Fig. 5.2.6.2 -3) covering the sediment filled deep sea trench, the so called "Reloca" slump and continued upslope crossing a sediment basin like structure, which is observed to stretch along the strike of the margin between 35°15' S and 35°45' S at a water depth of about 1500 m. An array of three GI airguns with 250 cinch generator volume (105 cinch injector) was used as seismic source.

Seismic sections of the surface streamer do resolve trench sediments up to 2.5 sec. TWT. Bathymetry map and sub bottom profiler show that debris of the Reloca slump has been flushed all the way across the central graben within the sediment infill of the trench. Clear separations between slumped debris and later sediment coverage can be identified on the streamer section (Fig. 5.2.6.4.). Upslope the base wall of the slump seems to be free of any sediment coverage (Fig. 5.2.6.5.). Horizontal layered reflective strata is cut off by the base of the slope wall. At water depth shallower than 1725 m a BSR is observed with discontinuous amplitudes. At depth 1725 m depth it terminates out at seafloor level along the interface between the hanging wall above a sediment filled graben. At 1500 m depth a 5 km wide 750 m deep graben is imaged. The variable layering of the filling sediments imply a variable tectonic history of uplift, subsidence and erosion over time (Fig. 5.2.6.6).

A preliminary first arrival tomography has been completed using the code of Korenaga (Fig. 5.2.6.7). Within the coverage of the deployed instruments the top of the downward bending oceanic plate can be imaged. The thick sedimentary infill of the trench is well covered. As well the topographic anomalies caused by the slumped debris are covered. Up to kilometre 40 the slope forming sediments are imaged with a thick sequence of lower velocities. At 40 km the almost vertical discontinuity to higher velocities could be interpreted as the landwards termination of the accretionary wedge.

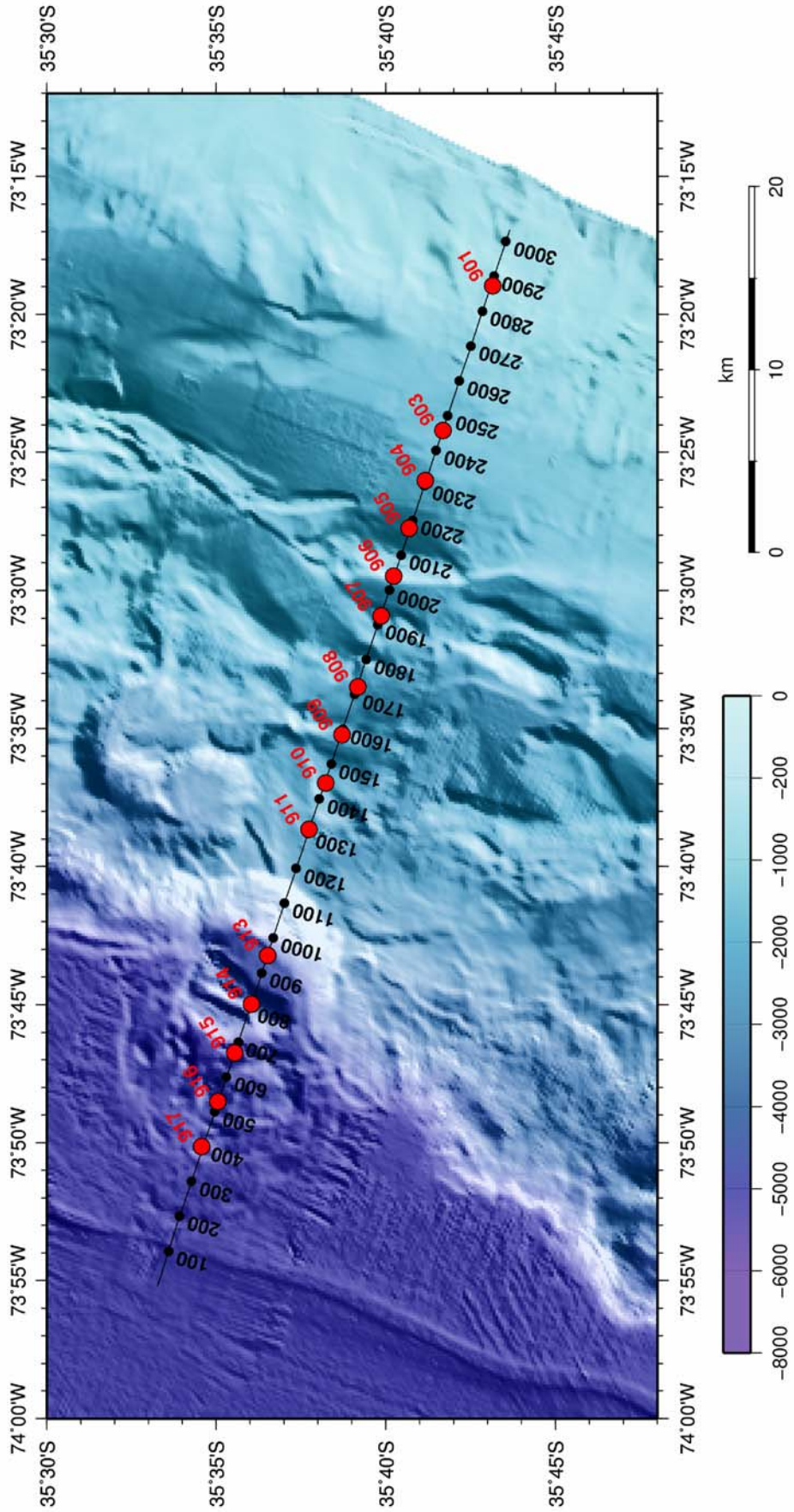

Figure 5.2.6.1.:Location map of JC23b seismic profile P09. Bathymetry is underlain

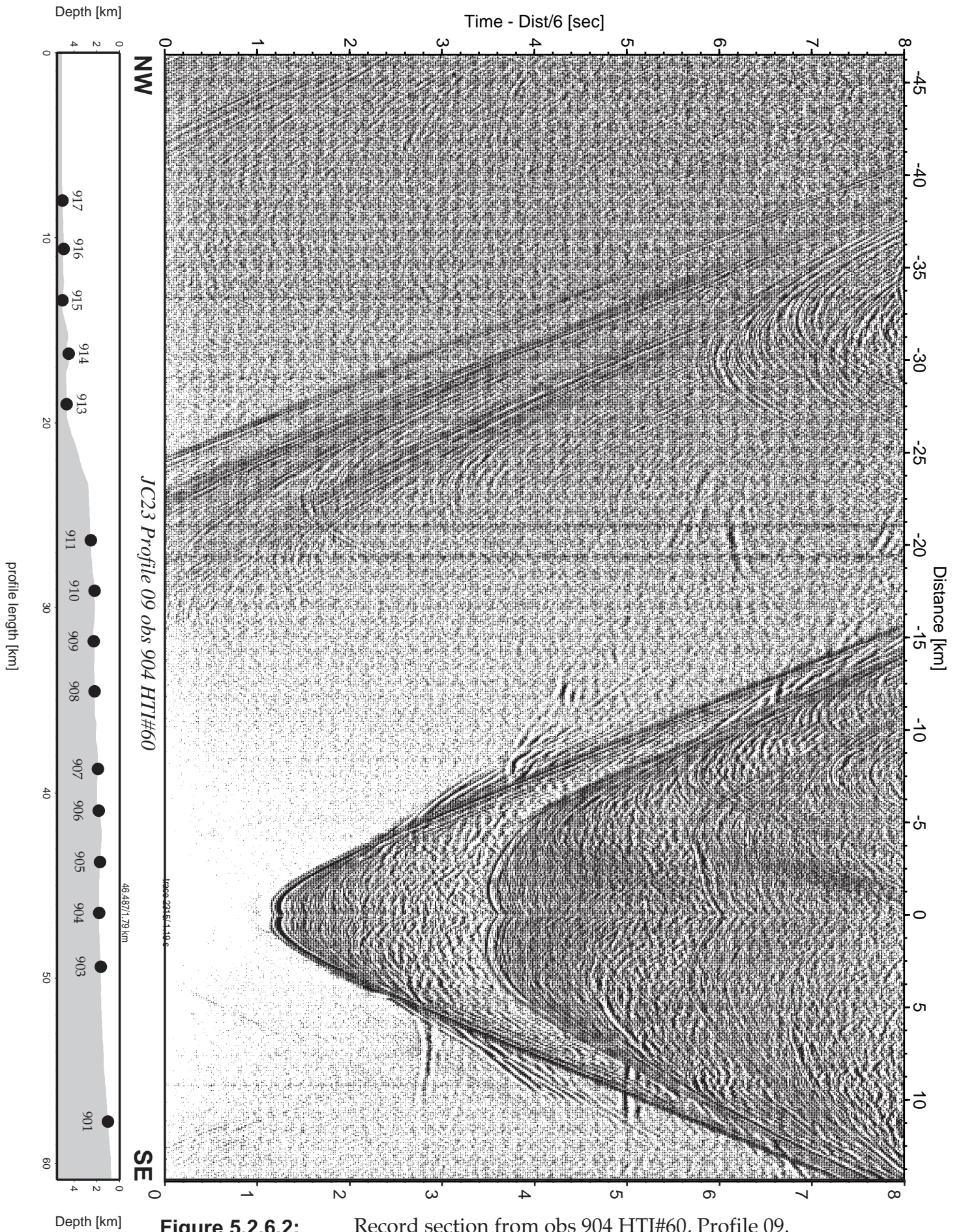

Figure 5.2.6.2: Record section from obs 904 HTI#60, Profile 09.

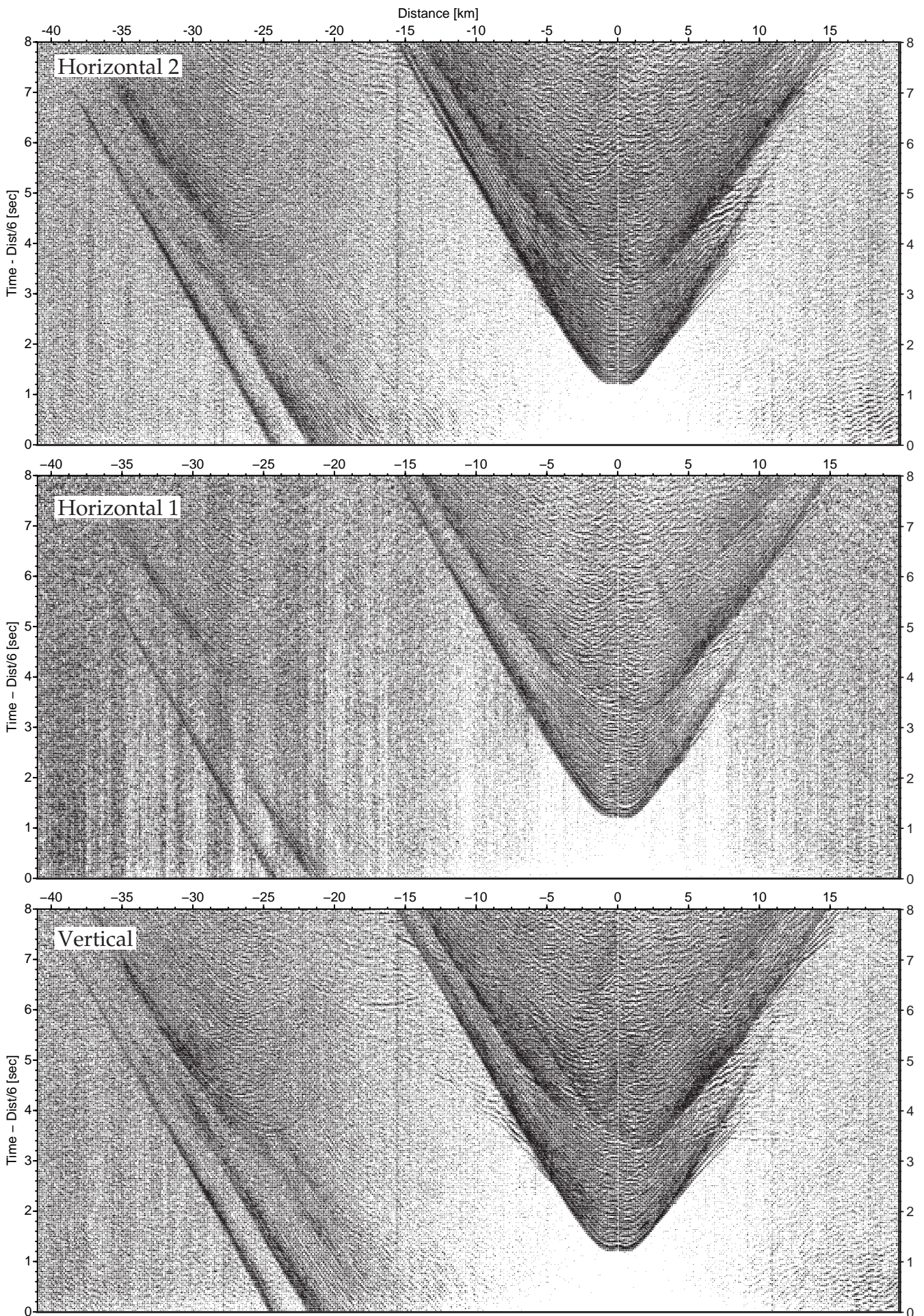

Figure 5.2.6.3 : Record sections from obs 906 (OAS/Owen-4.5Hz Geophone), Profile 09.

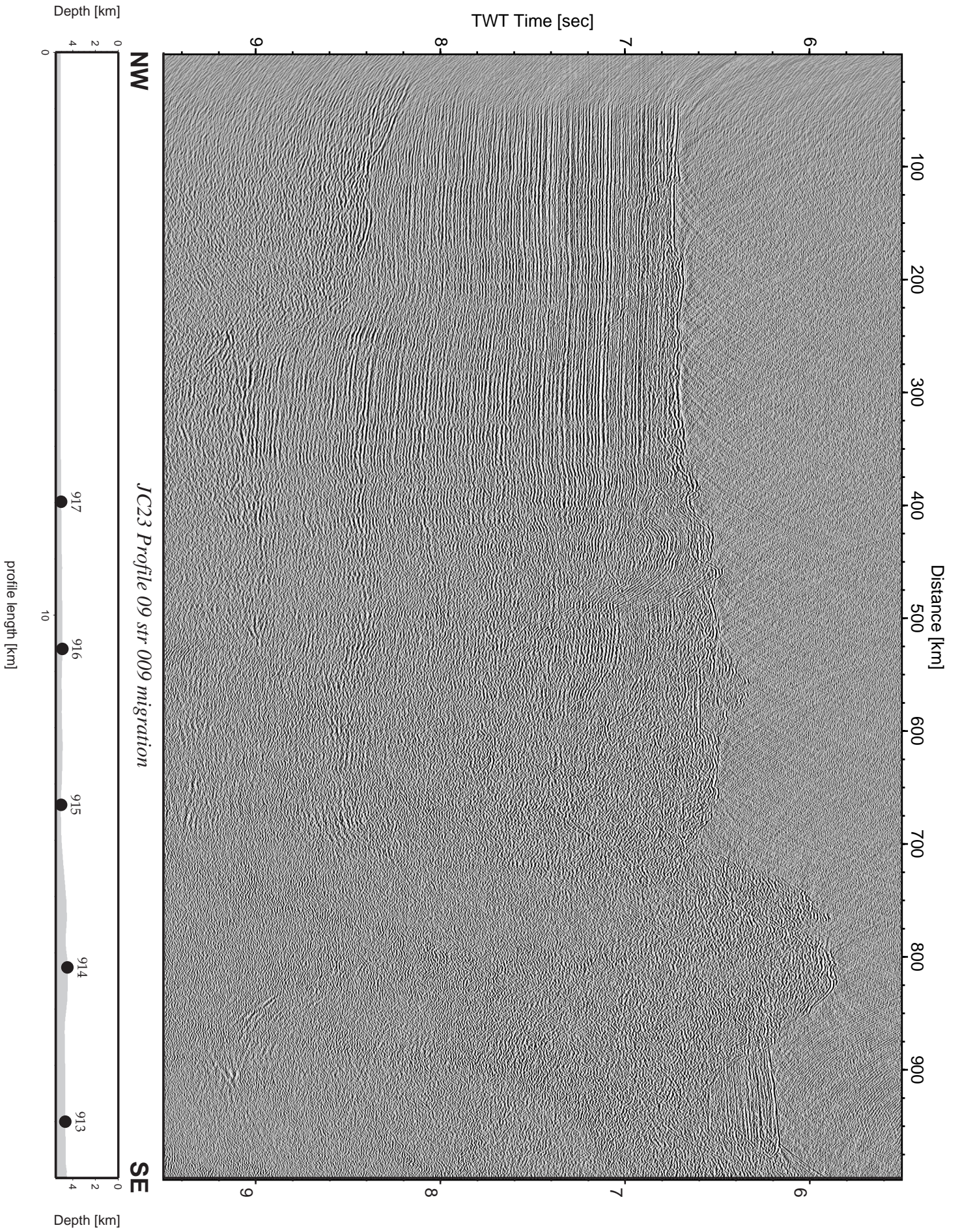

Figure 5.2.6.4 : Record section from str 009 migration, Profile 09.

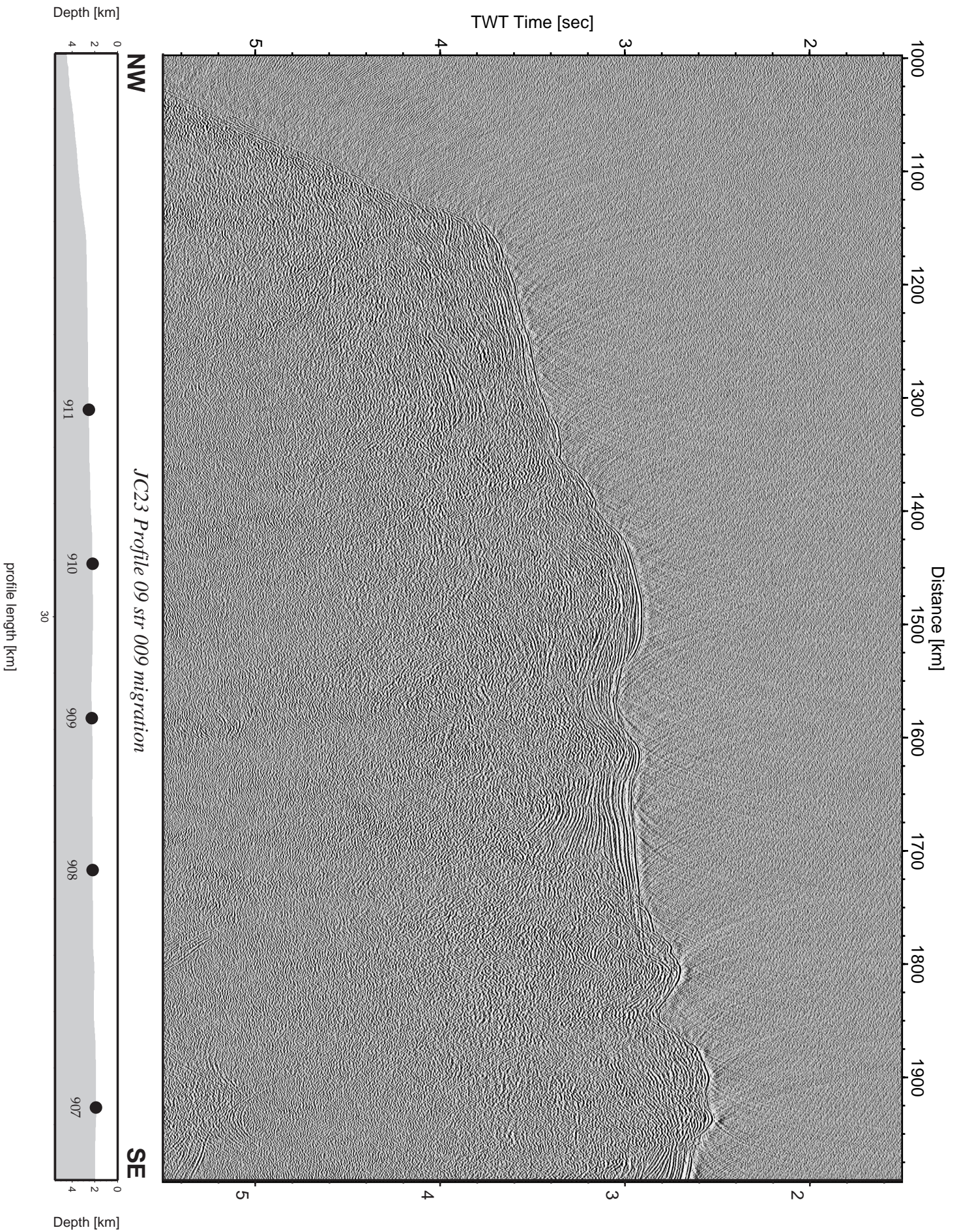

Figure 5.2.6.5 : Record section from str 009 migration, Profile 09.

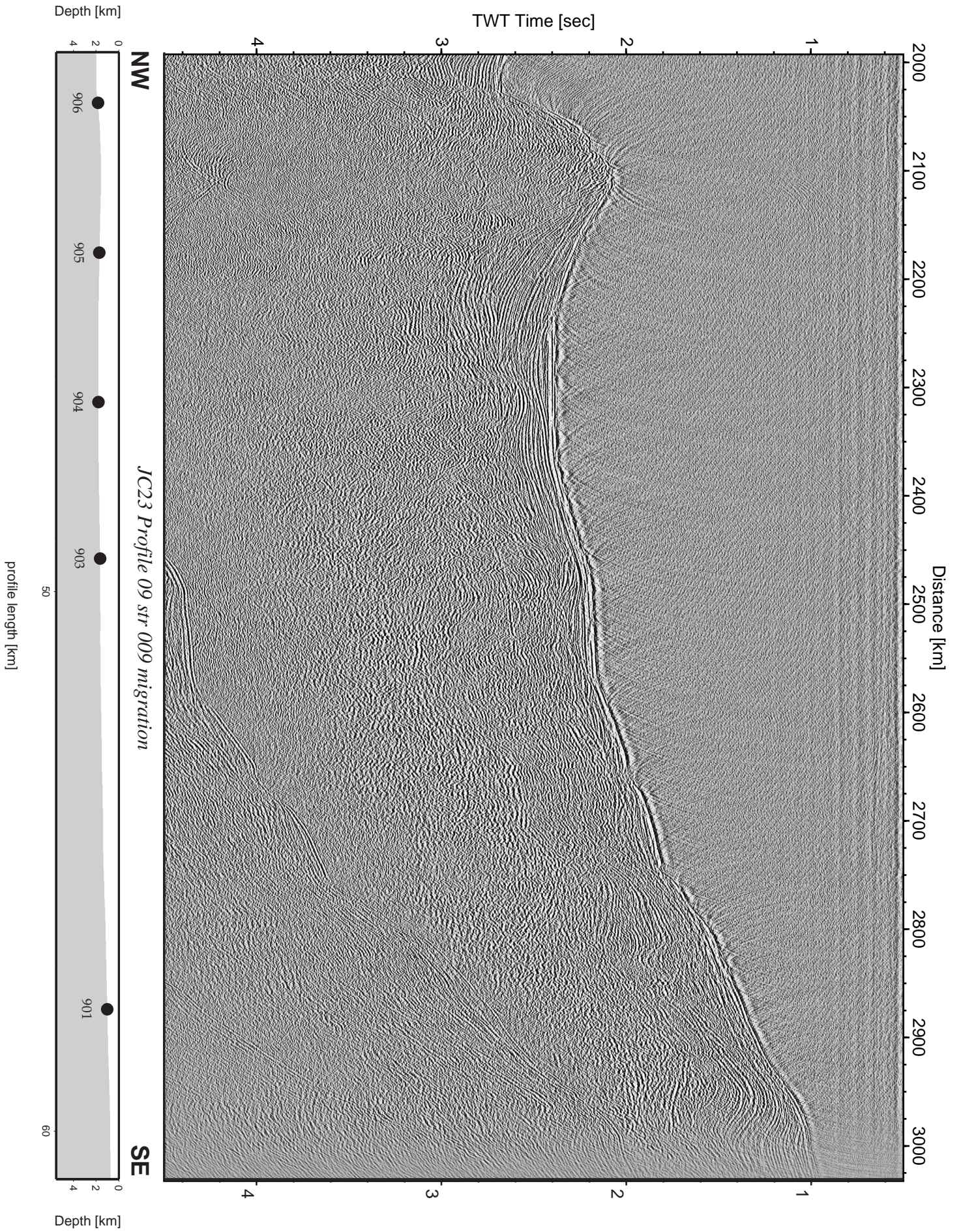

Figure 5.2.6.6 : Record section from str 009 migration, Profile 09.

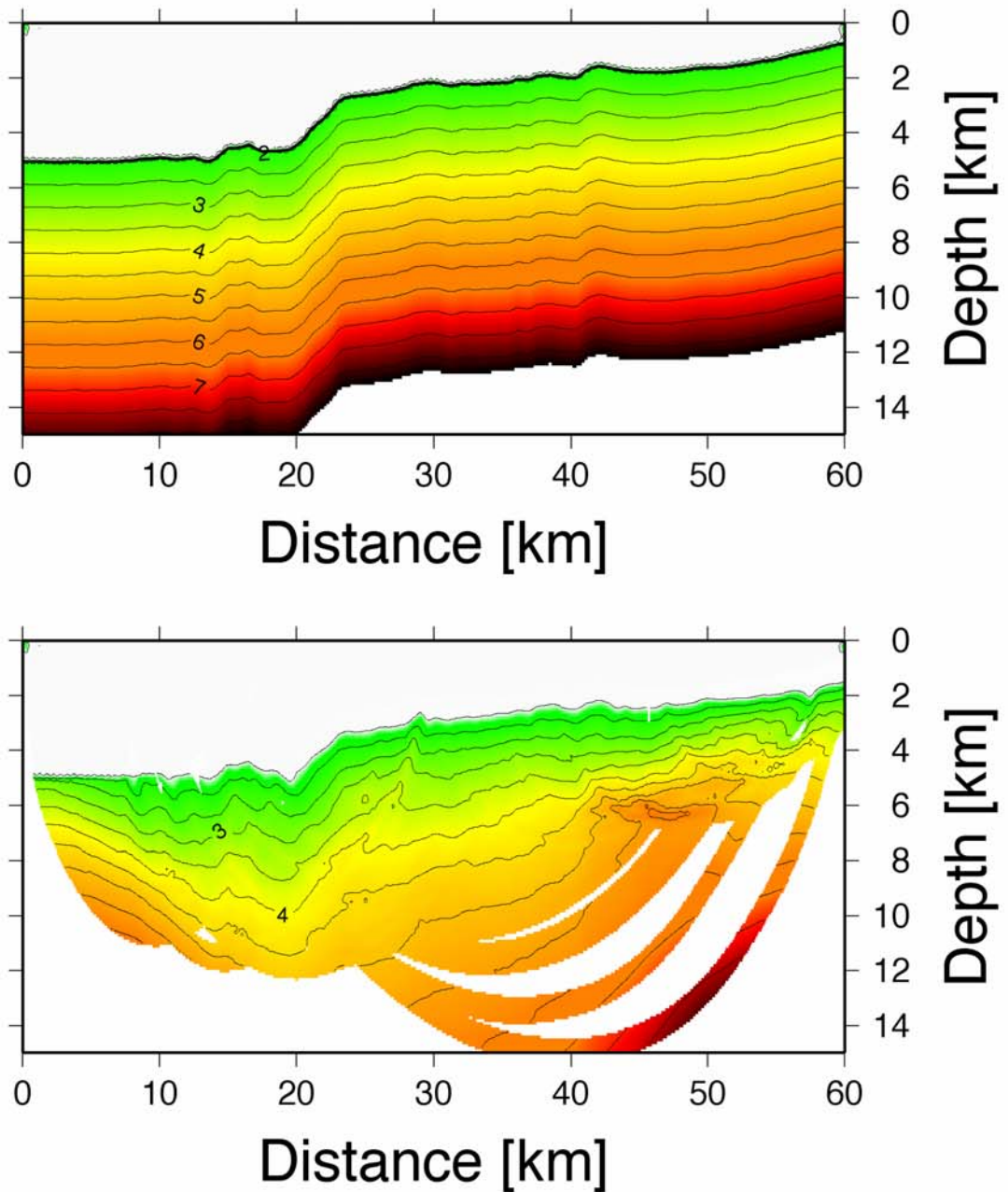

Fig: 5.2.6.7: First arrival tomography using code of Korenaga
 - top of the down dipping oceanic plate is modeled at the left border
 -thick sedimentcover of the trench is clearly imaged with the topographic undulations of the slumped debris
 -low velocities observed up kilometer 40 may image the accretionary wedge

5.2.7 Profile 10

Deployment of 19 OBS (example sections Fig. 5.2.7.2-3) along profile 10 (Fig. 5.2.7.1.) was done in an area between 35°45' S and 36° S at about 1,500 m water depth. The area was chosen according to noticeable structures found on seismic images of the Chilean cruise VG02, which were kindly provided by Juan Diaz, University of Valparaiso. Six parallel profiles were run with the deep towed sidescan while 3 GI airguns each equipped with 250 cinch generator and 105 cinch injector were shot at 13 sec interval. Besides the OBS a 4 channel surface streamer recorded the shots as well.

The streamer images repeat the major structures observed on the VG02 line (Fig.5.2.7.4-8).

A slightly elevated seafloor at kilometre 35. The uplift seems to be effective for all sediment layers down to the signal penetration of 800 ms TWT. Internal reflections observed to the side cannot be traced underneath the structure. Nevertheless no further indications have been found, which might indicate the presence of a mud volcano. Following the bathymetry map the location is next to slightly elevated ridge like structural elevations towards the NE and SW, which might form the image at this location. Next to the NE end of the profile a second slightly pronounced seafloor elevation is observed. Again reflections from the sides cannot be traced well underneath it. On its southern termination it seems as if the seafloor reflection is doubled up. Within the bathymetry two minor highs are observed at this location close by without any sign of enhanced backscatter. Hence the reflection image might be affected by side effects.

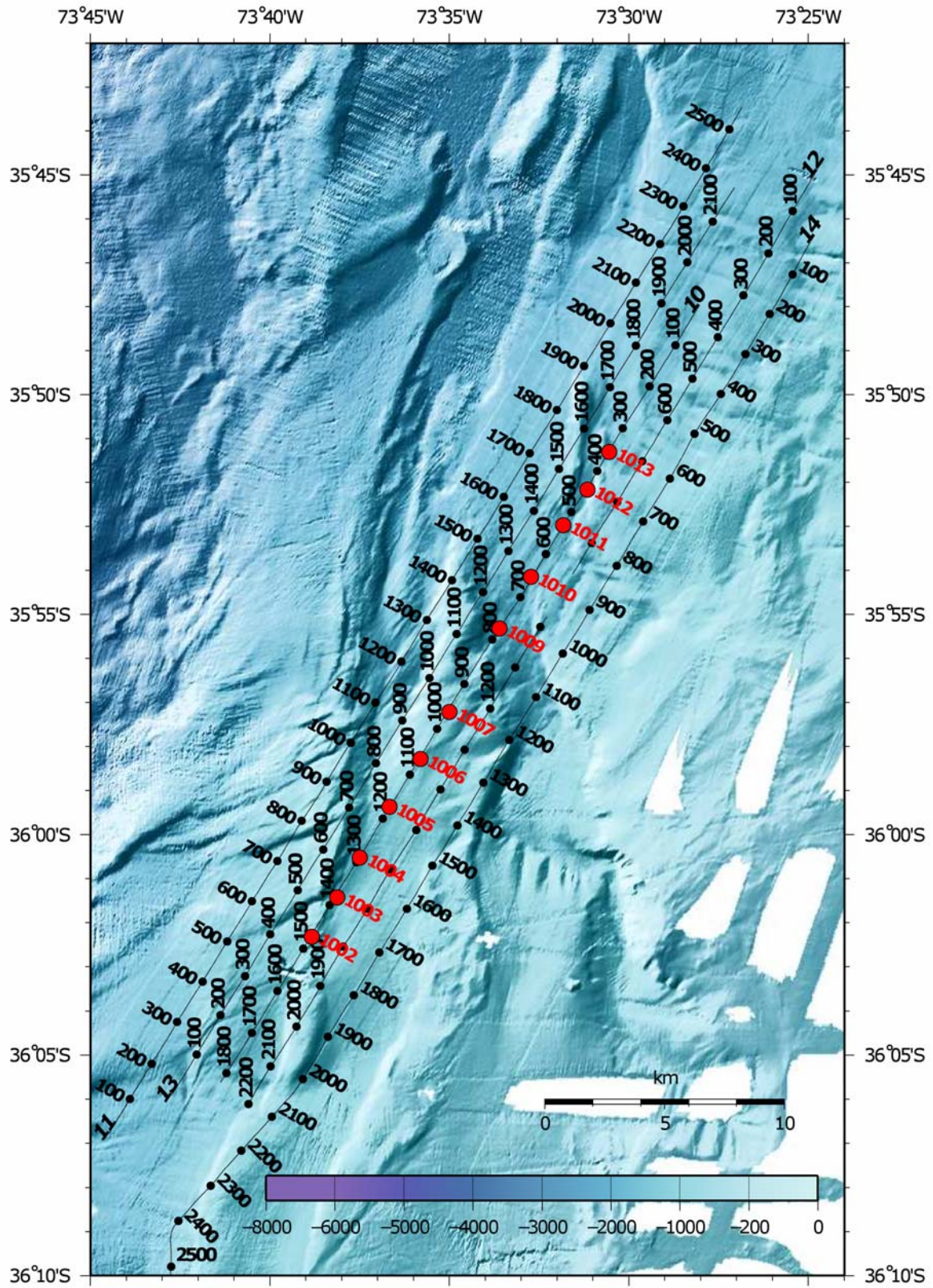

Figure 5.2.7.1.: Location map of JC23b seismic profile 10. Bathymetry is underlain

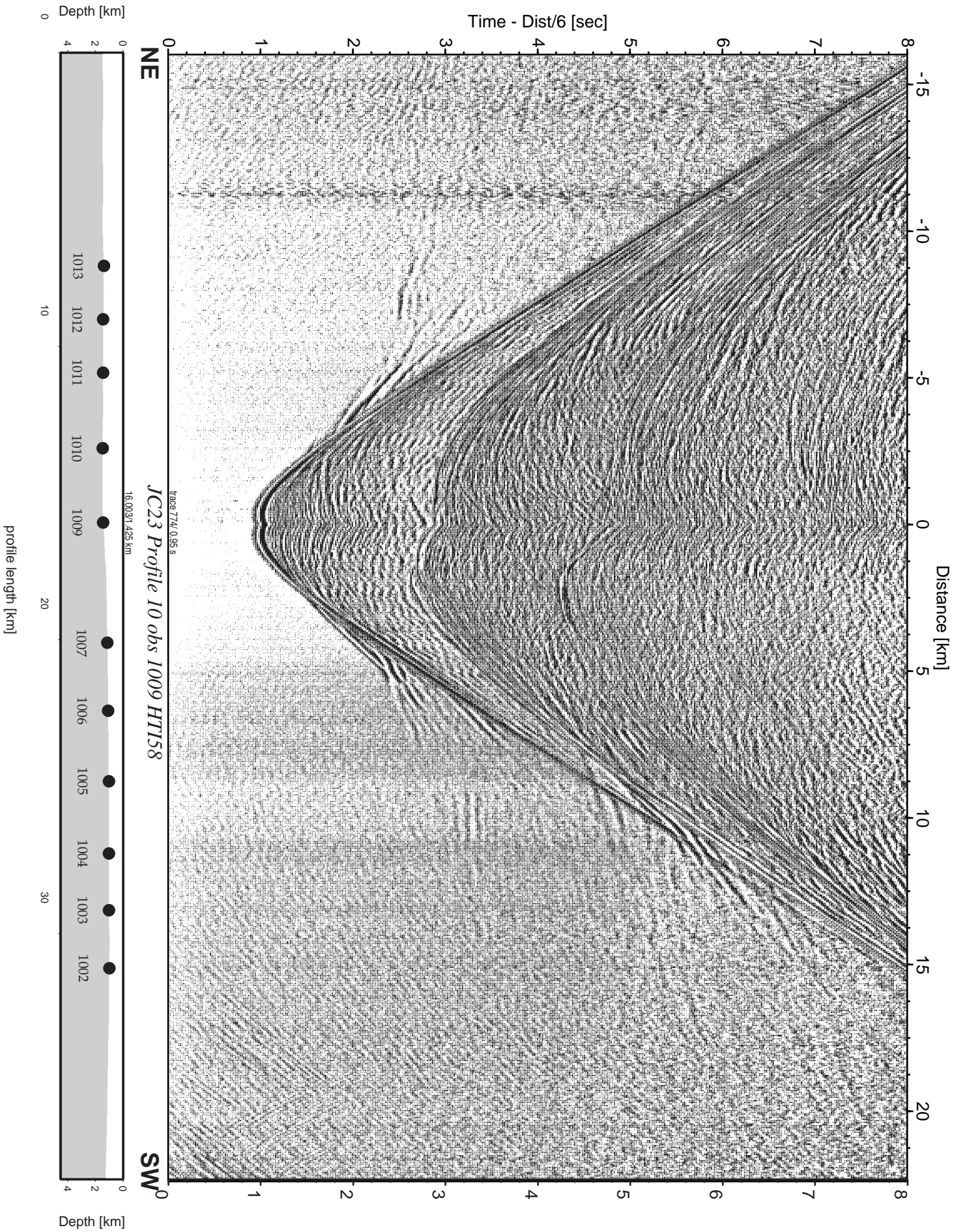

Figure 5.2.7.2 : Record section from obs 1009 HTI58, Profile 10.

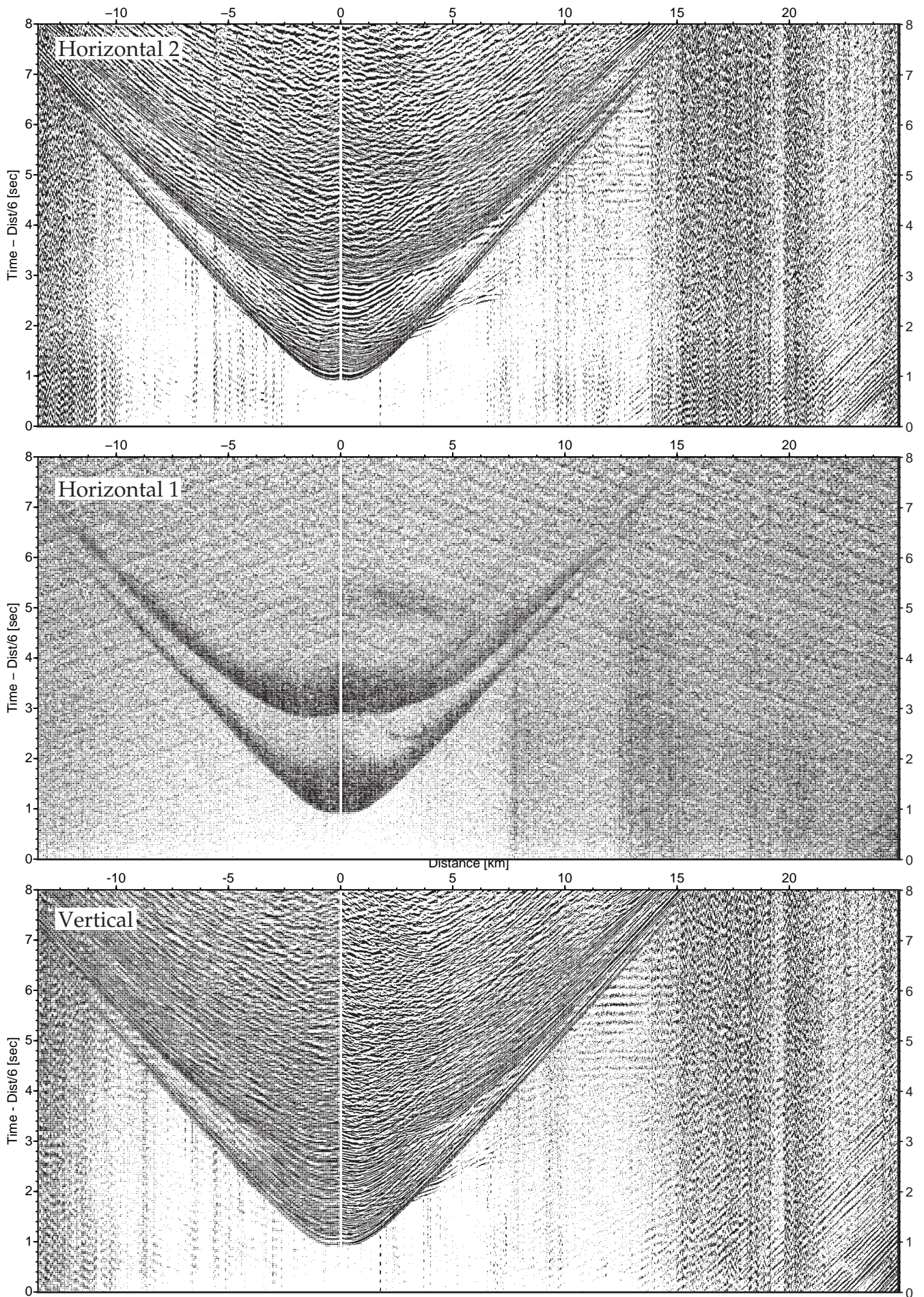

Figure 5.2.7.3 : Record sections from obs 1010 (HTI/Owen-4.5Hz Geophone), Profile 10.

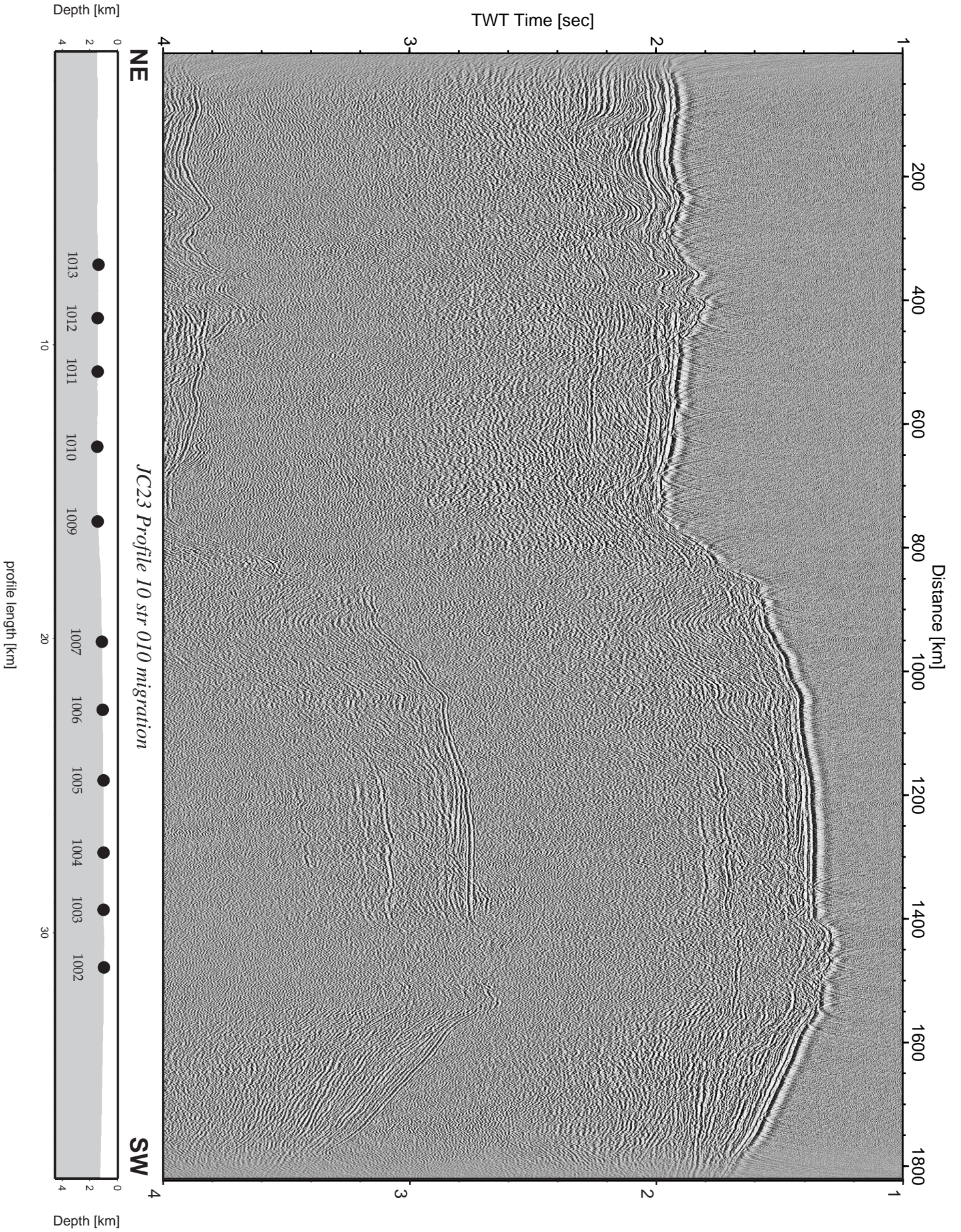

Figure 5.2.7.4 : Record section from str 010 migration, Profile 10.

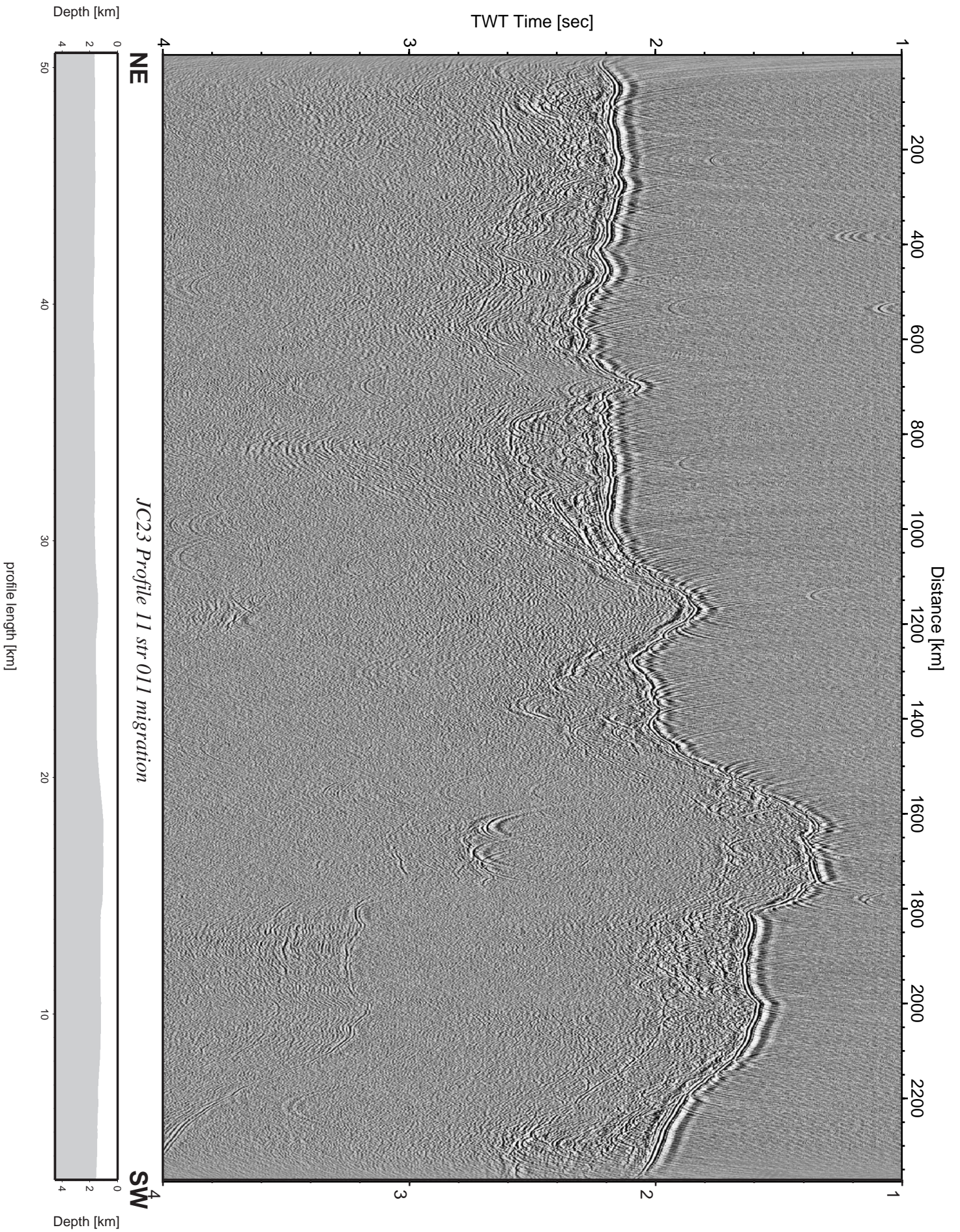

Figure 5.2.7.5 : Record section from str 011 migration, Profile 11.

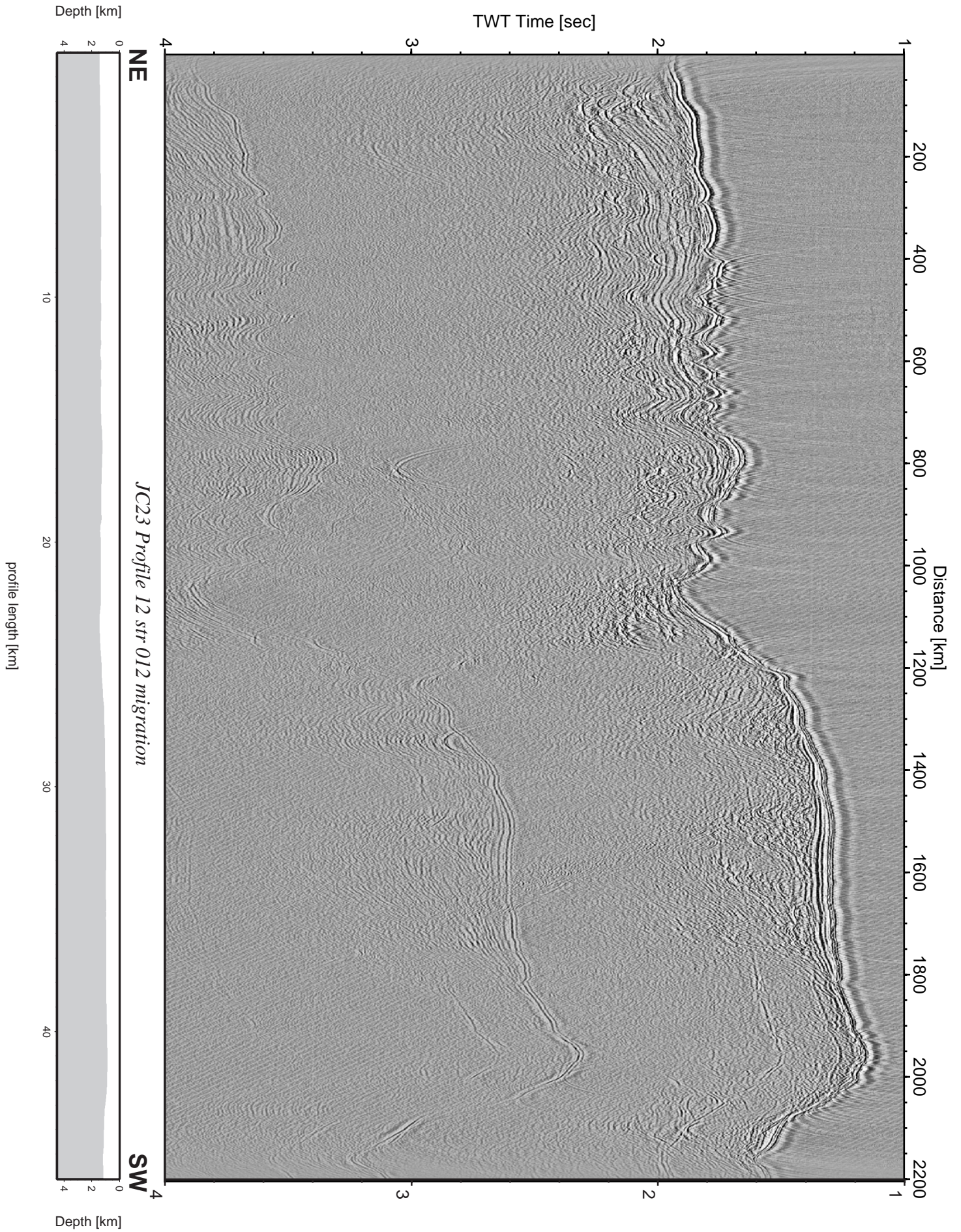

Figure 5.2.7.6 : Record section from str 012 migration, Profile 12.

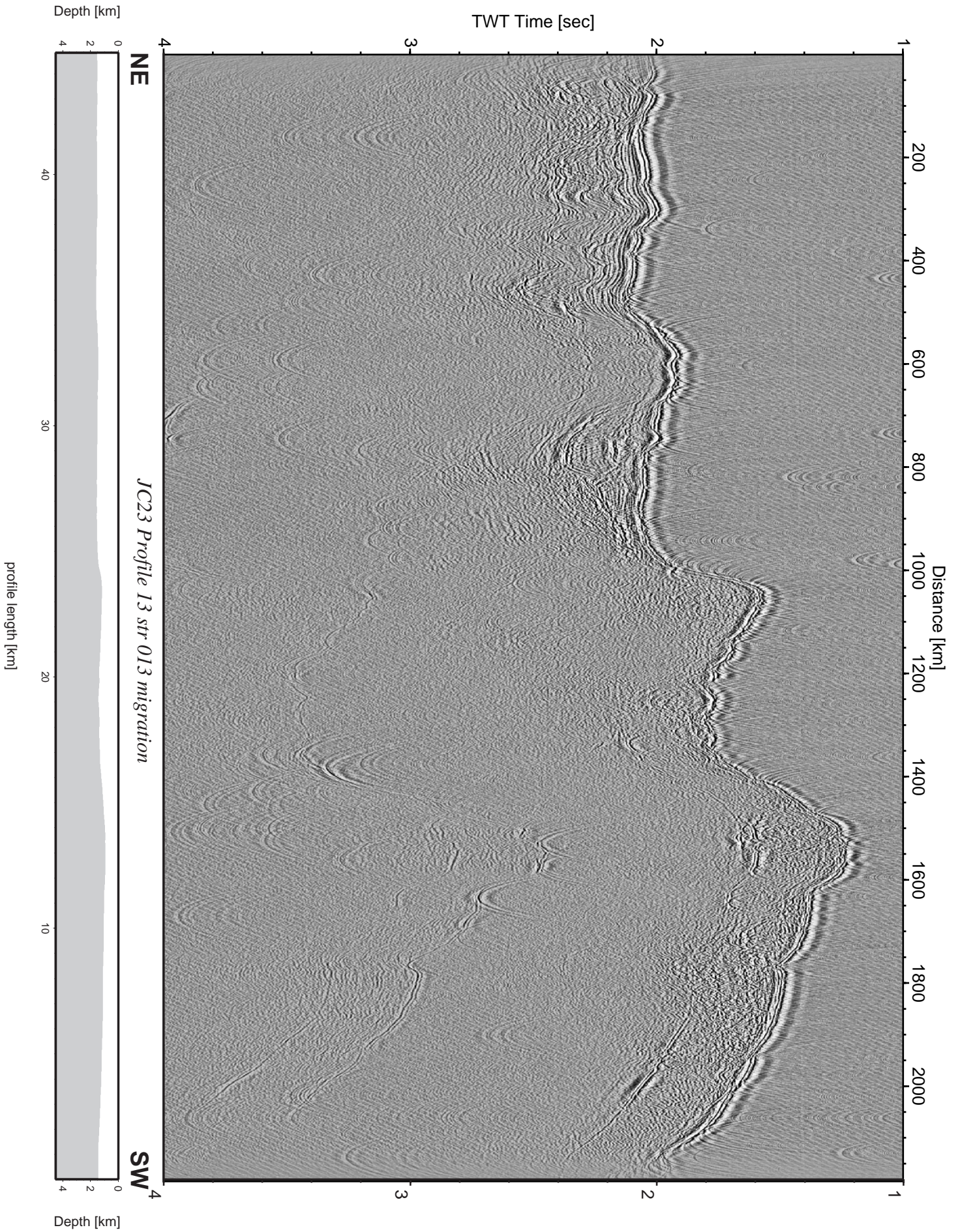

Figure 5.2.7.7 : Record section from str 013 migration, Profile 13.

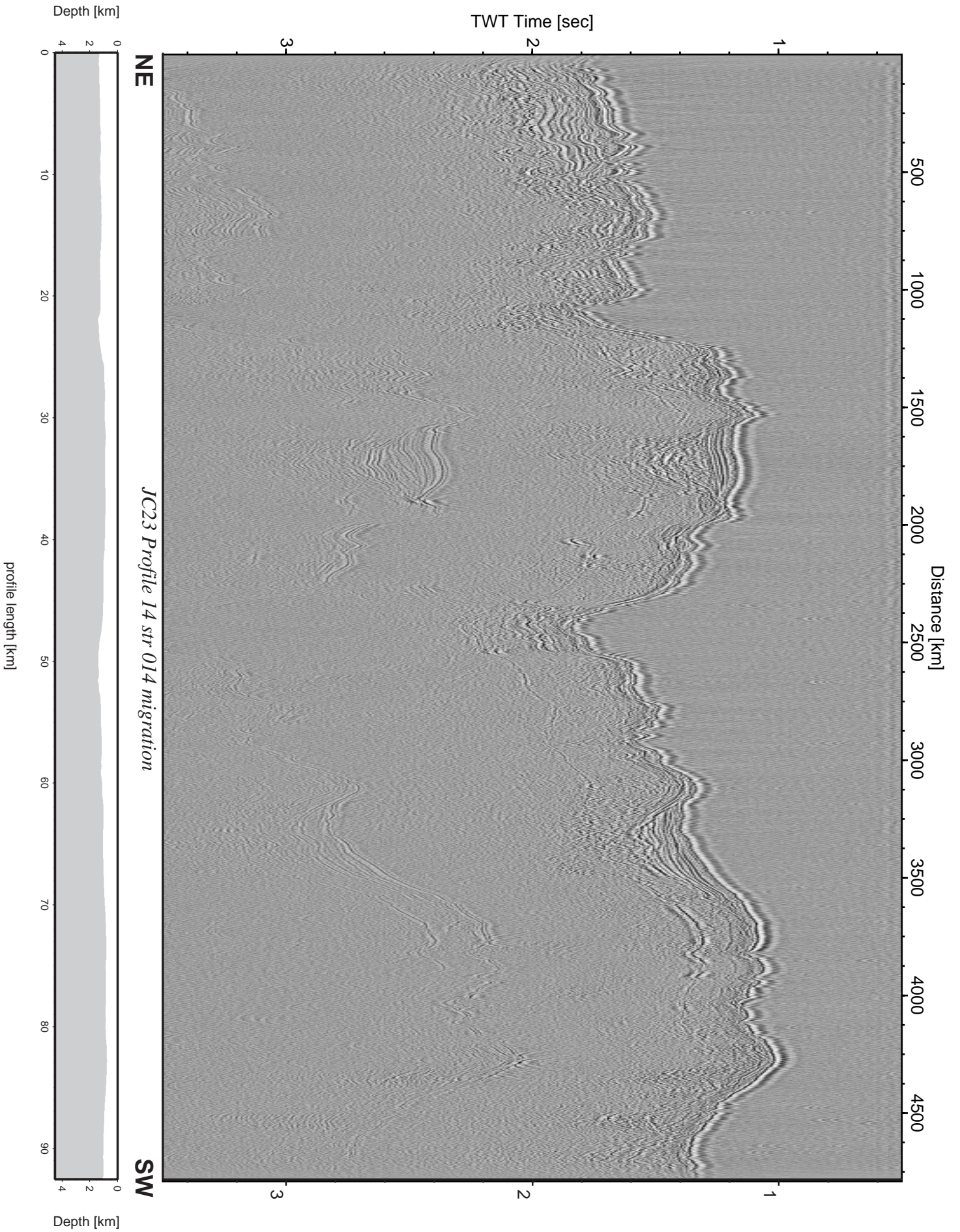

Figure 5.2.7.8 : Record section from str 014 migration, Profile 14.

5.2.8 Profile 11

Profile 11 (Fig. 5.2.8.1) was covered with 16 OBS (example sections Fig. 5.2.8.2-3) and 3 OBH/M stretching from 36°18' S to 36°34' S. It is located next to the area where cores taken during M67 did show some smelly indication for the presence of Methane. The instruments were positioned across the top hills of a high cliff like elevation. To the west the seafloor dips steeply down to a small plateau some 600 m below, while to the east a flat seafloor is shown in the bathymetric map. Due to intensive reprocessing of the swath data a grid with 50 m cell width could be provided. Here small circular features were indentified, which might be related to fluid venting. Unfortunately the weather conditions during this survey were not best for seismic acquisition. High wave state (up to 4 m swell) and strong winds (up to 8/9 Bft) increased noise on the streamer records. In addition it turned out that obviously the reflected energy from the operated 3 GI airguns (250 / 105 cinch) caused oversaturation within the streamer. Nevertheless sediment coverage could be imaged next to the peak elevations of the seafloor (Fig.5.2.8.4-9). Patchy continuations of reflections underneath these highs need to be further investigated and compared with image displays of the OBS. Instruments were closely spaced along the tops of the highs while wider offsets should ensure continuous coverage along the line in between. BSR reflections are observed with variable depths. Major unconformity in the BSR is found next to the elevation at 32 kilometers. This is coincident with strong flare observations in the deep towed sidescan data.

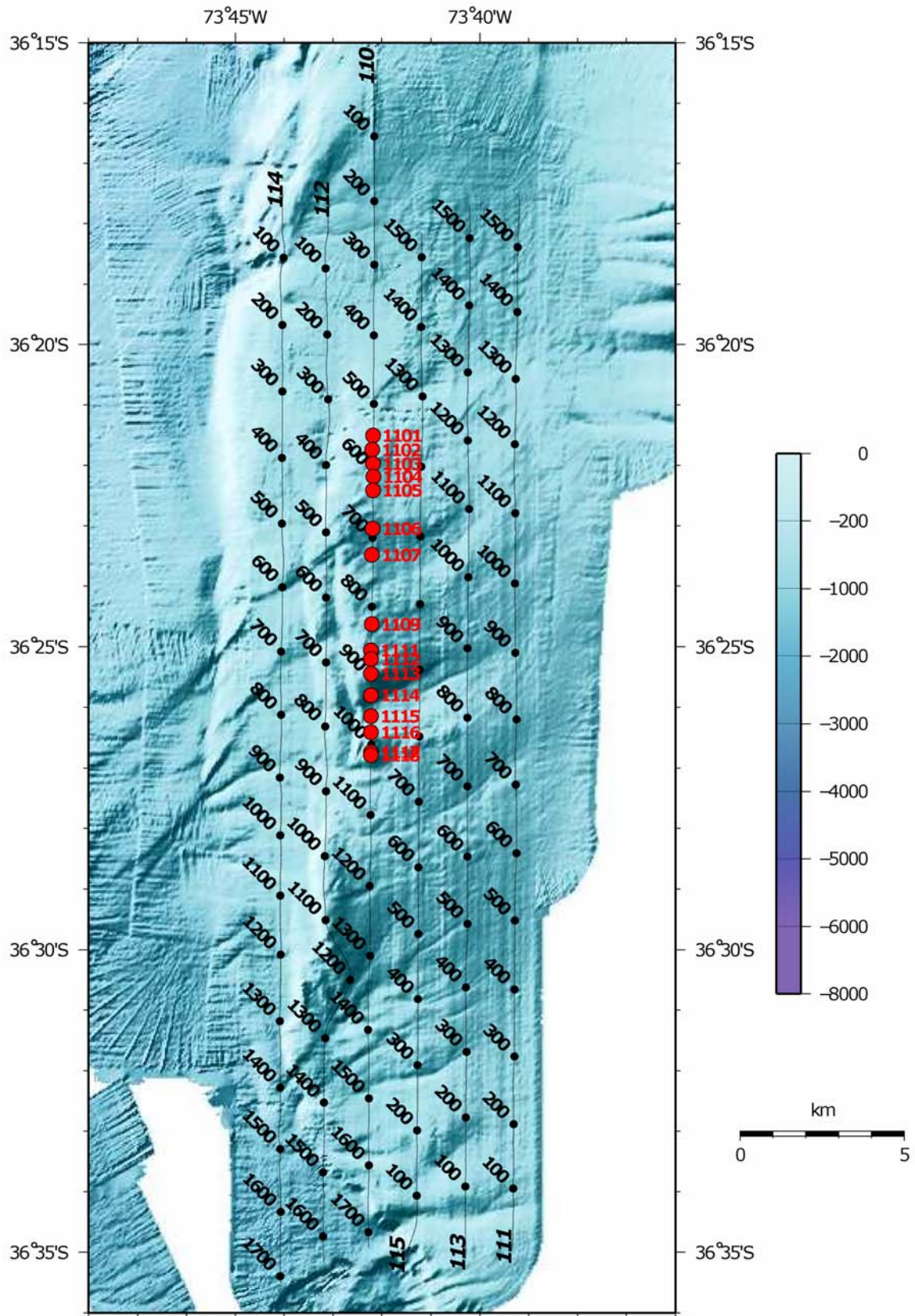

Figure 5.2.8.1.: Location map of JC23b seismic profile 11. Bathymetry is underlain

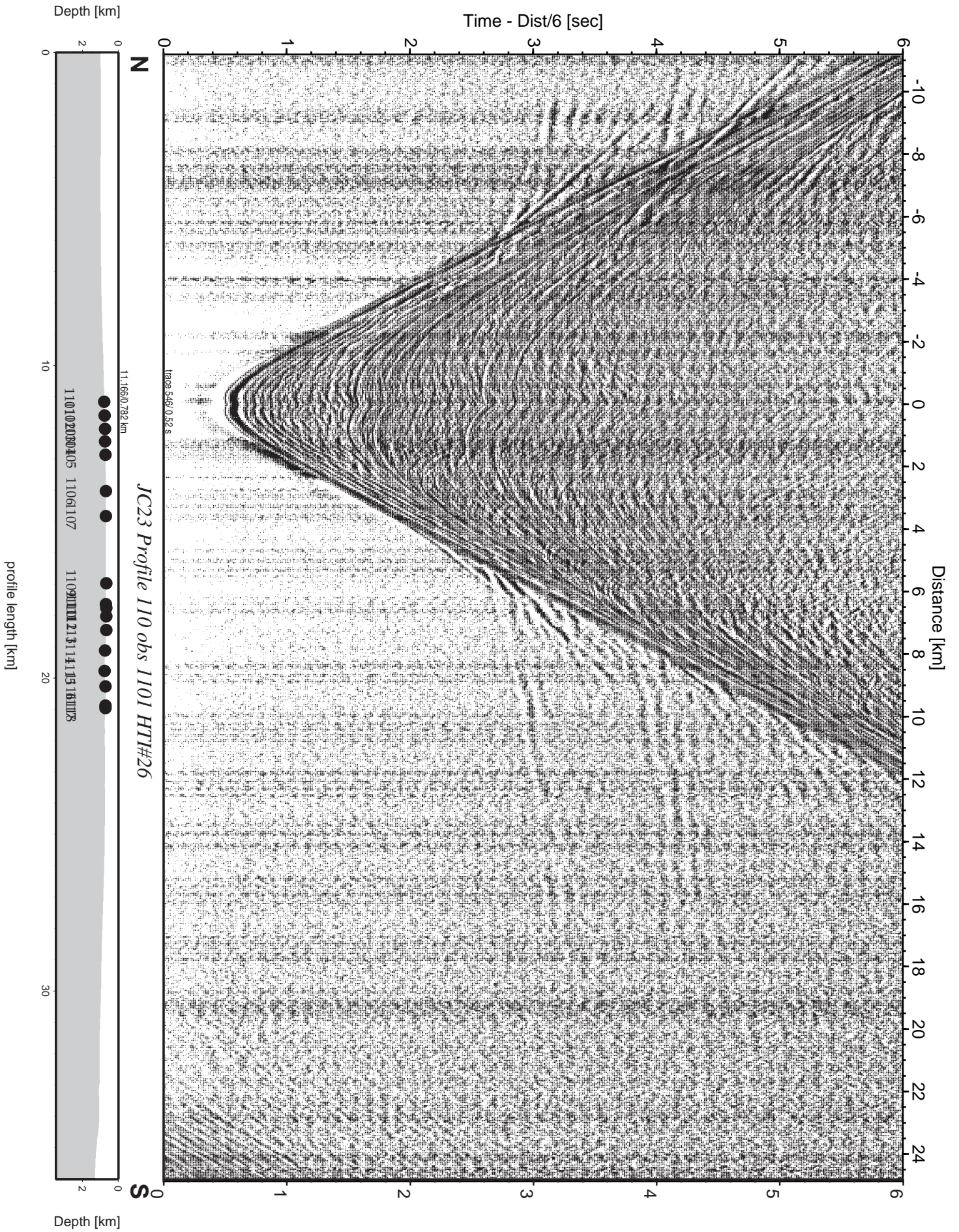

Figure 5.2.8.2 : Record section from obs 1101 HTI#26, Profile 110.

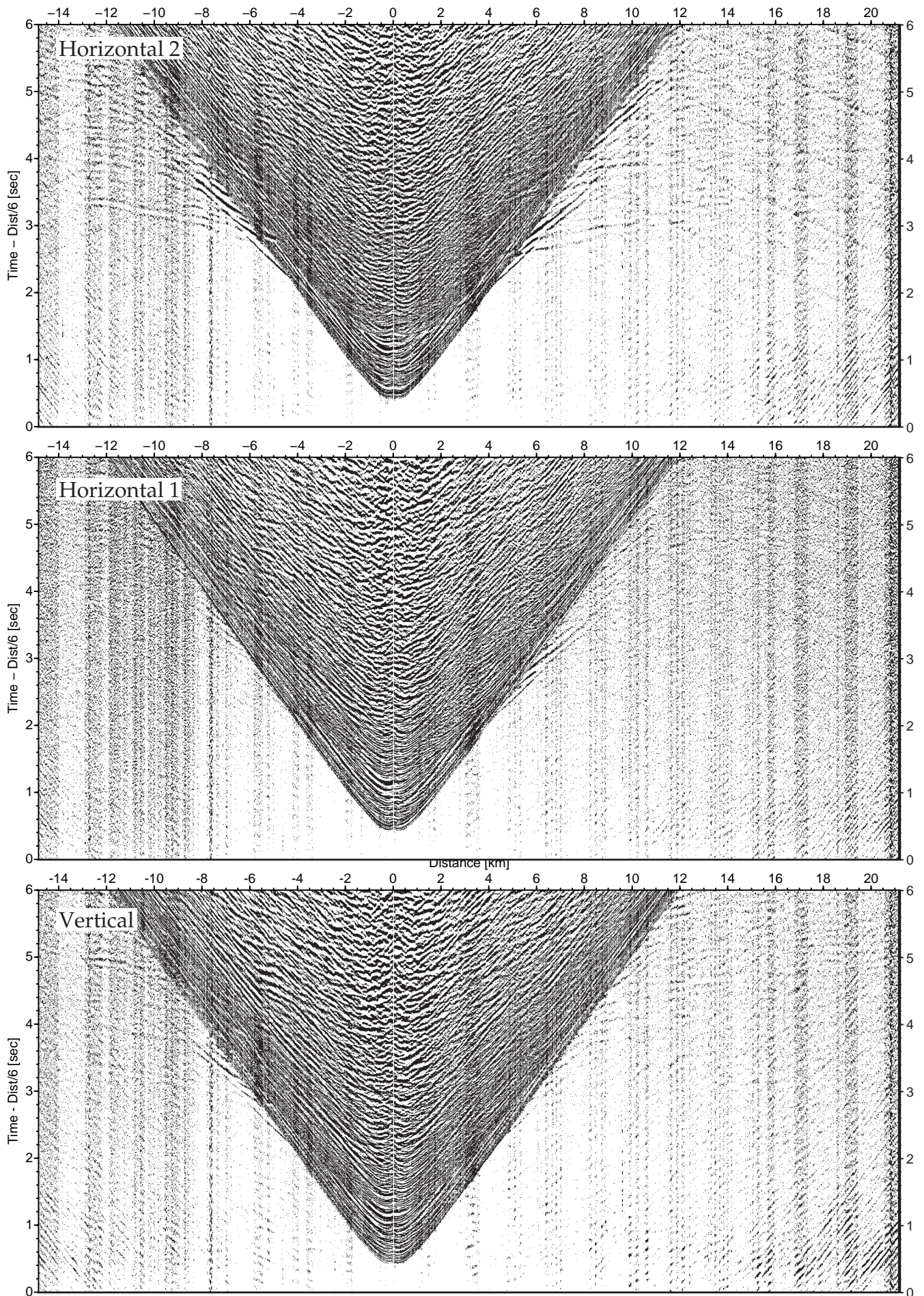

Figure 5.2.8.3 : Record sections from obs 1107 (HTI/Owen-4.5Hz Geophone), Profile 110.

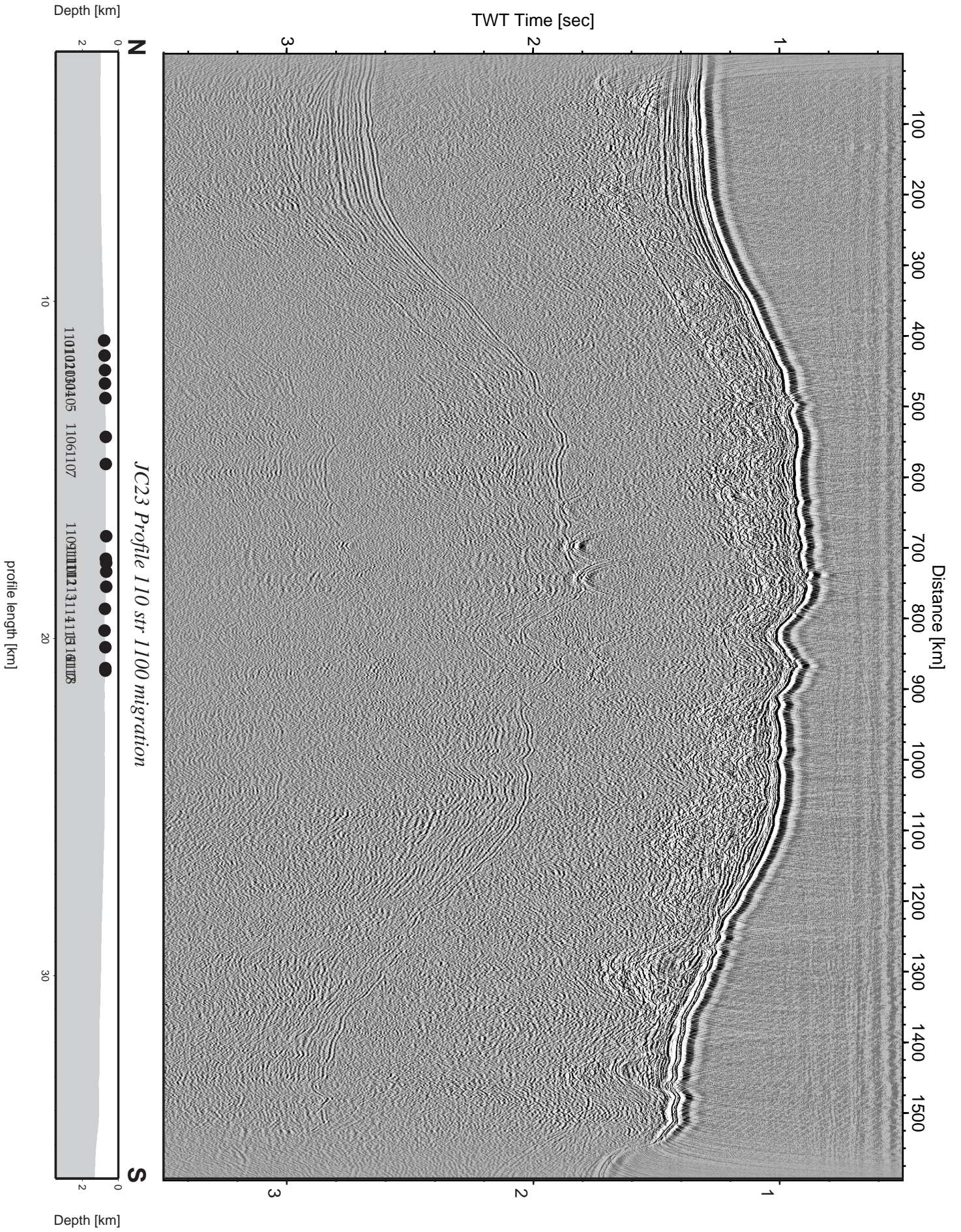

Figure 5.2.8.4 : Record section from str 1100 migration, Profile 110.

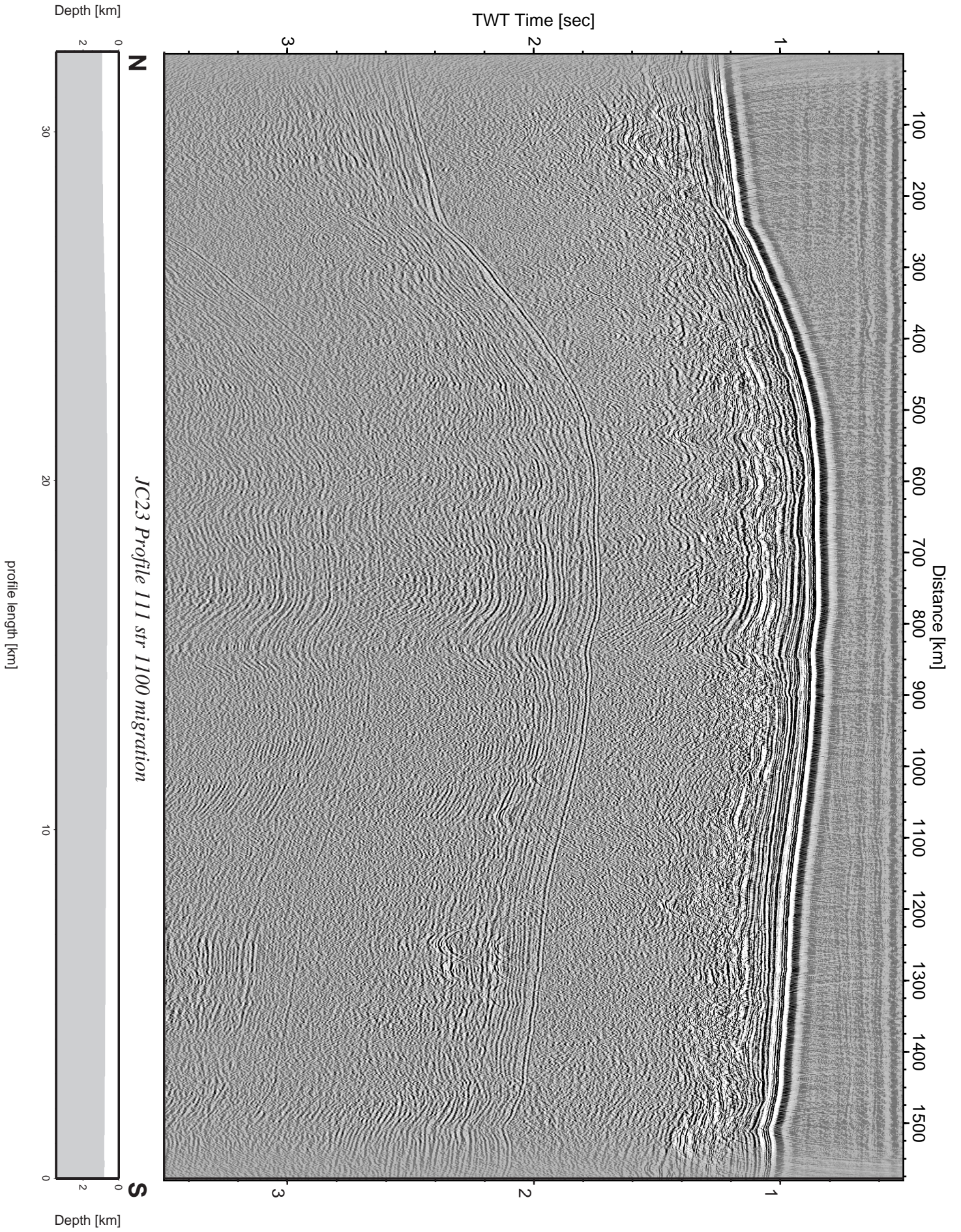

Figure 5.2.8.5 : Record section from str 1100 migration, Profile 111.

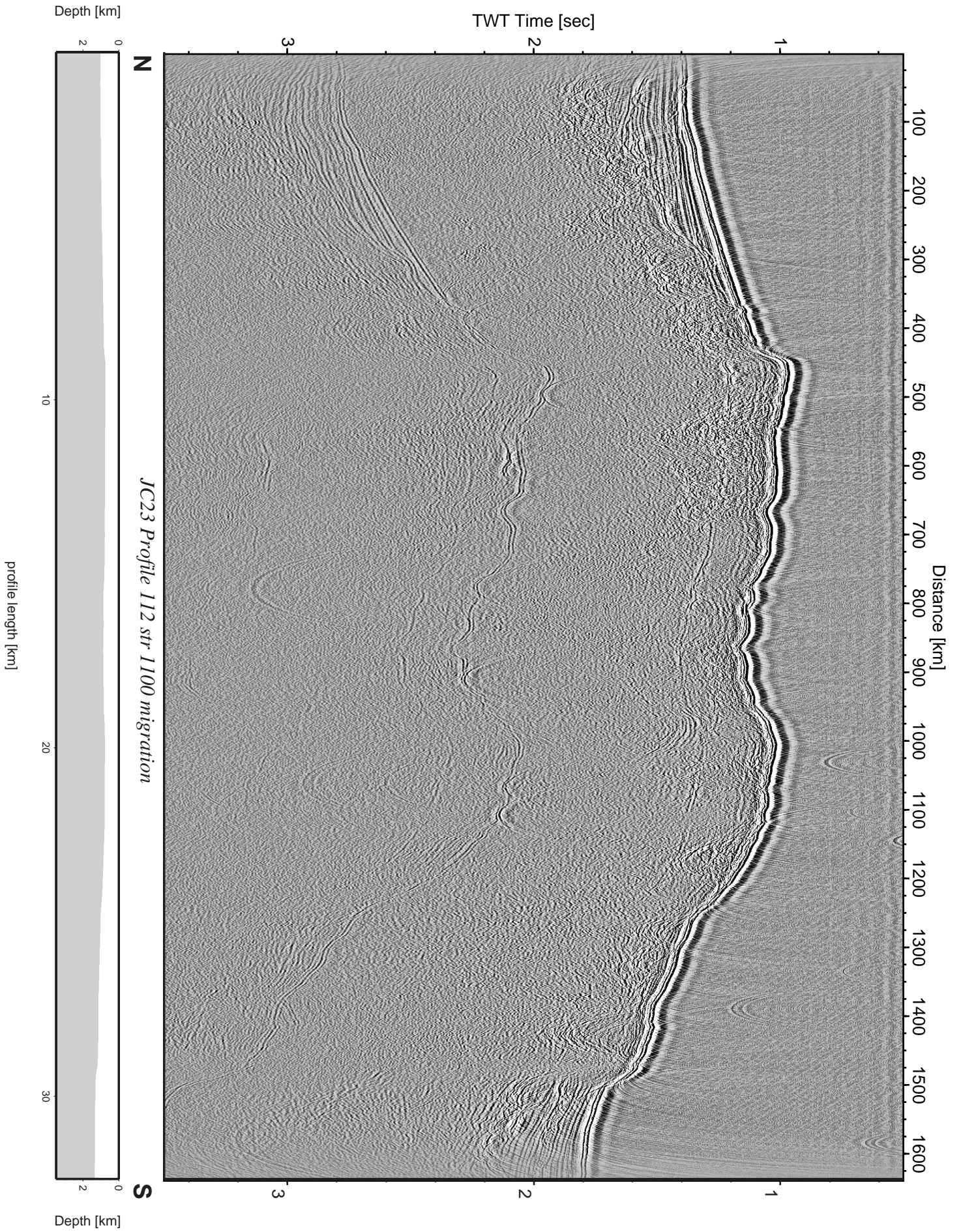

Figure 5.2.8.6 : Record section from str 1100 migration, Profile 112.

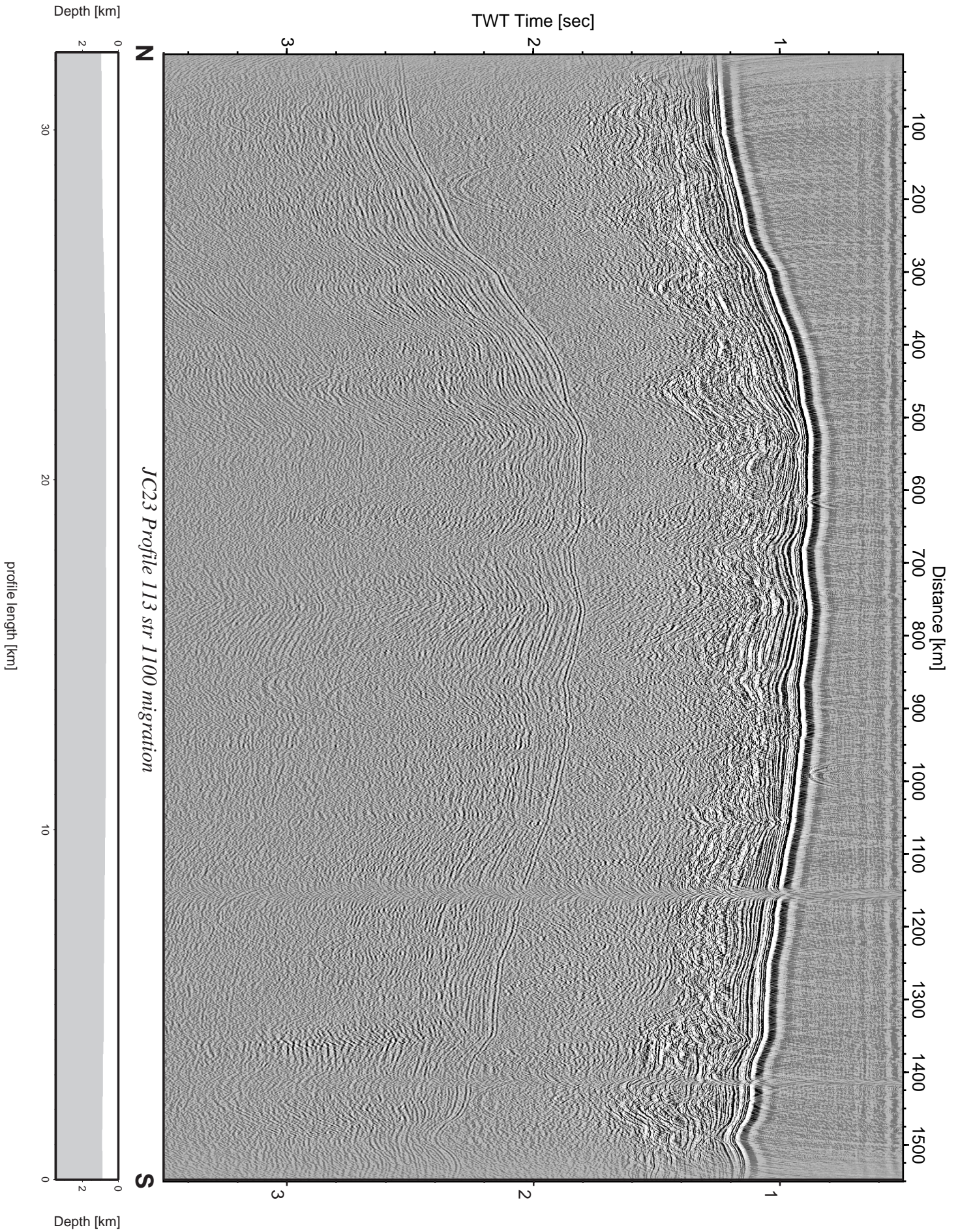

Figure 5.2.8.7 : Record section from str 1100 migration, Profile 113.

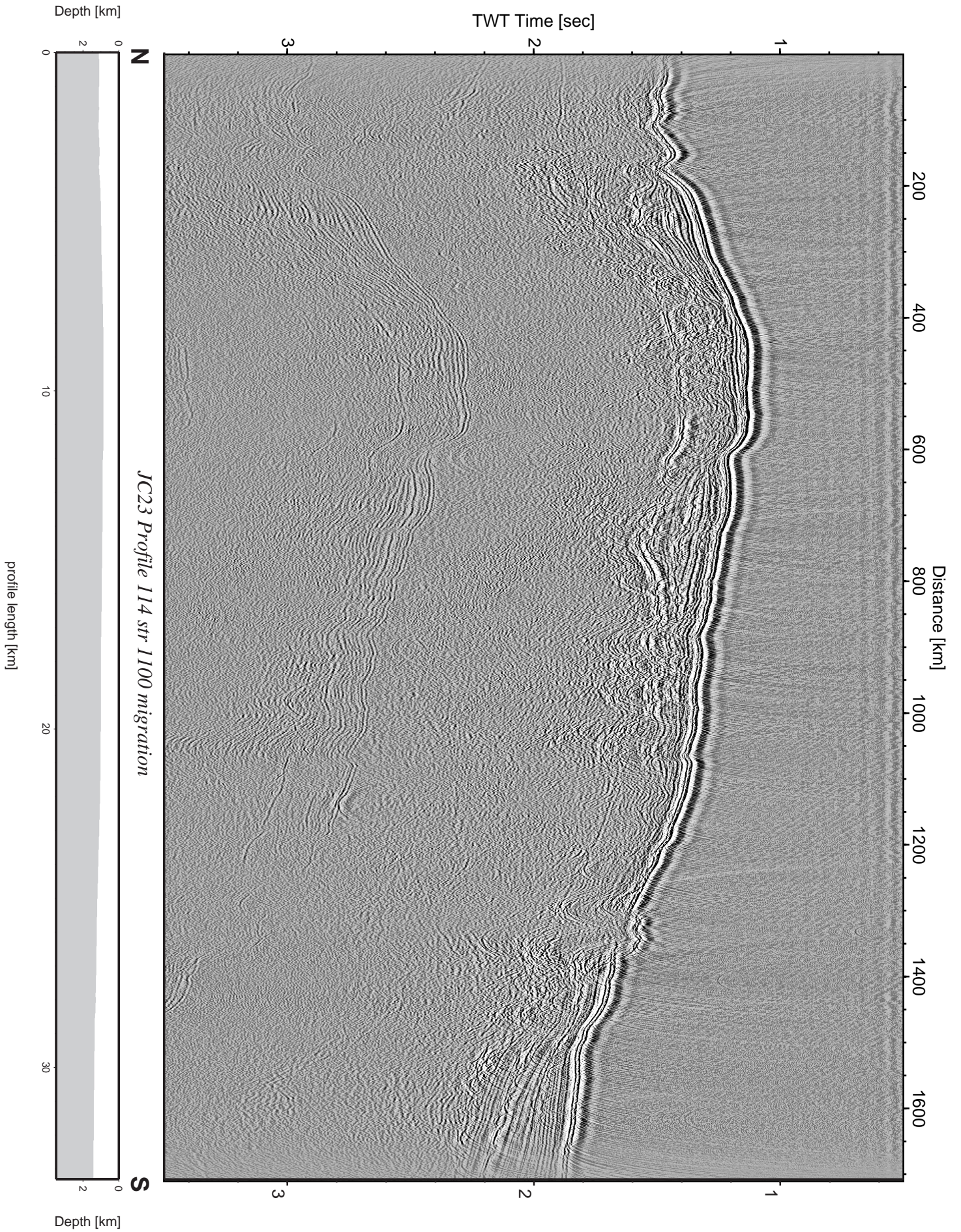

Figure 5.2.8.8 : Record section from str 1100 migration, Profile 114.

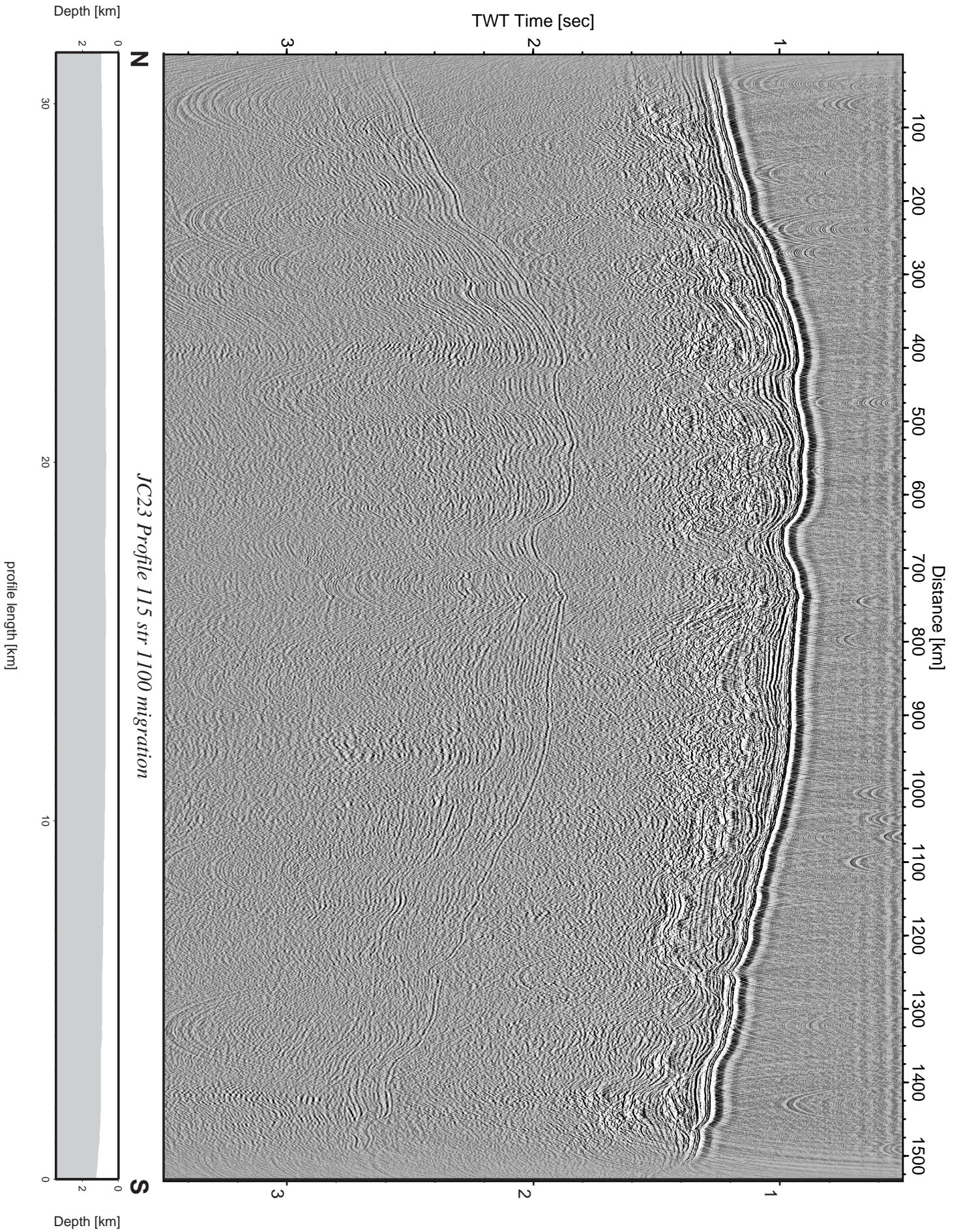

Figure 5.2.8.9 : Record section from str 1100 migration, Profile 115.

5.2.9 Profile 12

The area of profile 12 (Fig. 5.2.9.1.) was chosen at 35°31' S / 73°23' W the location of the "Valdés" slump. Again 19 OBS were deployed, this time distributed along two lines (example sections Fig. 5.2.9.2-5), one covering the head wall and the slump debris, the second covering the undisturbed side wall to the North. There occurrence of calyptogena had been reported from a dredge by our Chilean colleagues (Sellanes et al, 2004; Sellanes et al, 2005). Besides a single GI airgun (105 / 105 cinch) and the little surface streamer the deep towed sidescan was deployed to cover the area with a mesh of 6 profiles.

The slump occurred in landward direction from a ridge like structure, which forms the seaward termination of an elongated basin that can be observed in the bathymetry between 35°15' S and 35°45' S at about 1500 m water depth (Fig. 5.2.9.6-12.). Slump debris could be traced in the seafloor topography about half the width of the basin (5 km off the foot wall). Orientation of the sediment reflections indicate repetitive slump events interchanging with uplift tectonic and possible strong erosion along the sediment basin. A BSR reflection is observed at about 400 msec TWT. It shows increasing amplitudes underneath the ridge towards the hanging wall of the slump and can be traced all the way across the basin. Occurrence of the BSR in all parallel and cross lines does indicate its constant presence throughout this survey area. No indications for vent sites were found in the seismic data.

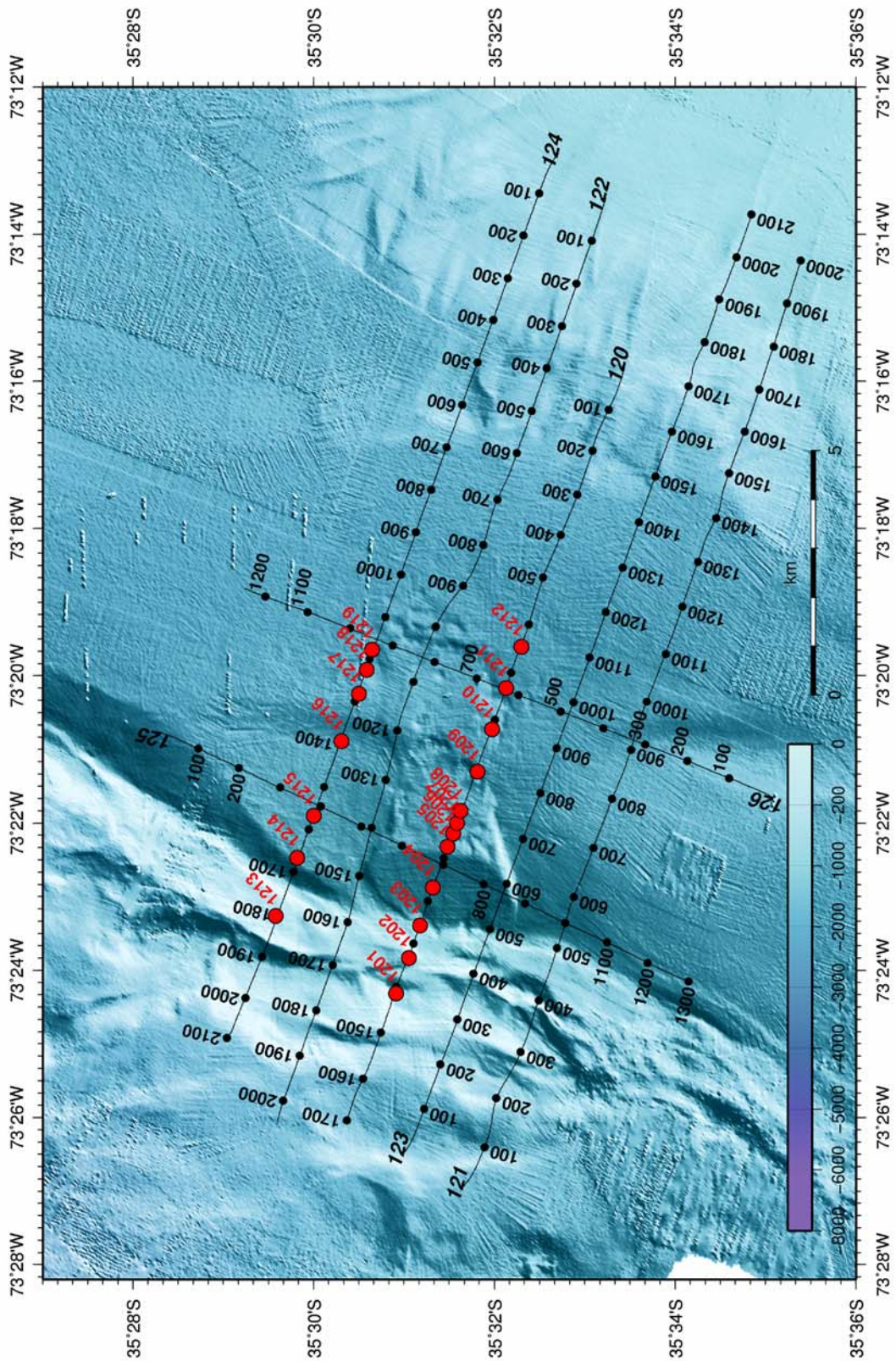

Figure 5.2.9.1.: Location map of JC23b seismic profile 12. Bathymetry is underlain

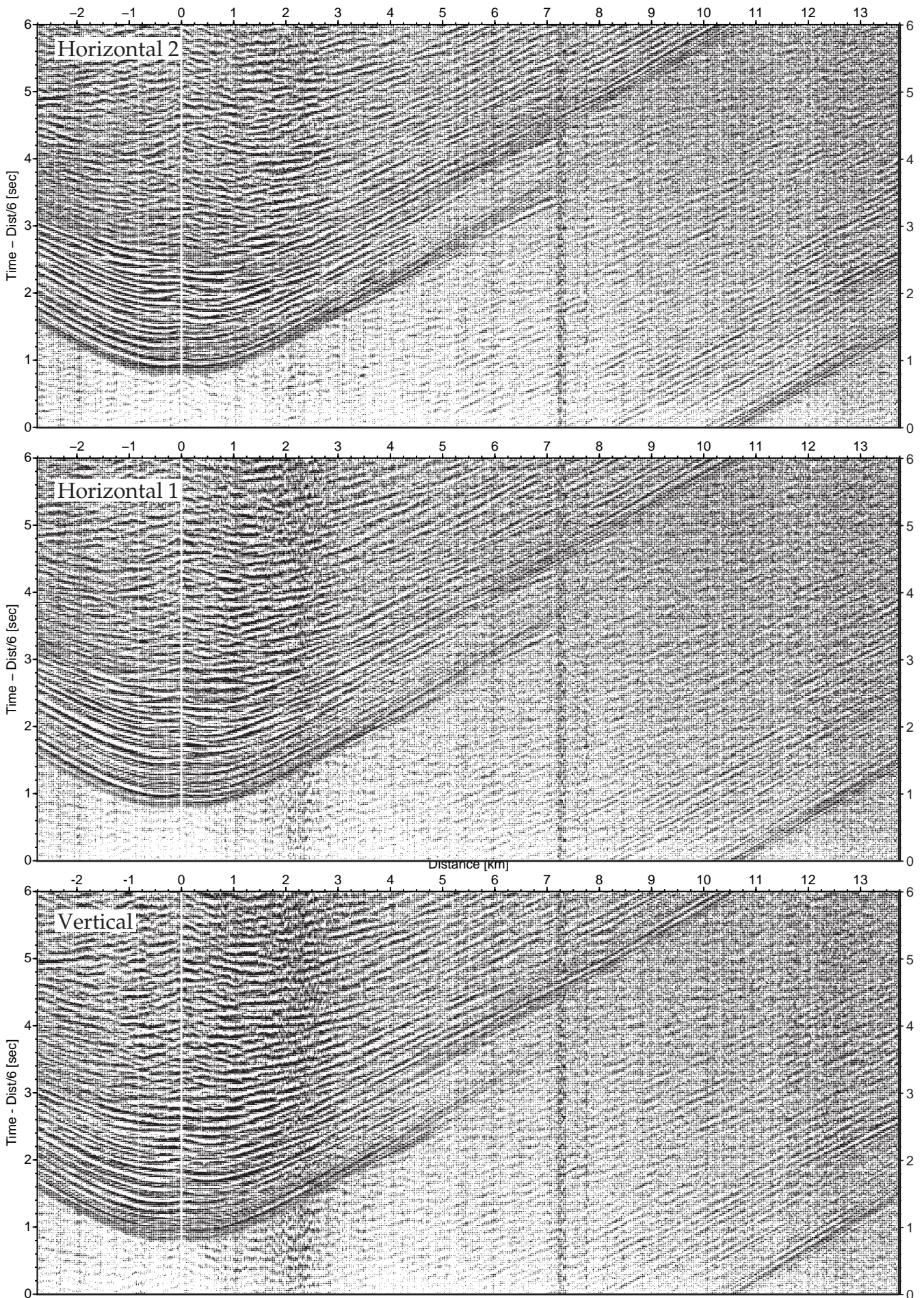

Figure 5.2.9.2 Record sections from obs 1201 (HTI/Owen-4.5Hz Geophone), Profile 120.

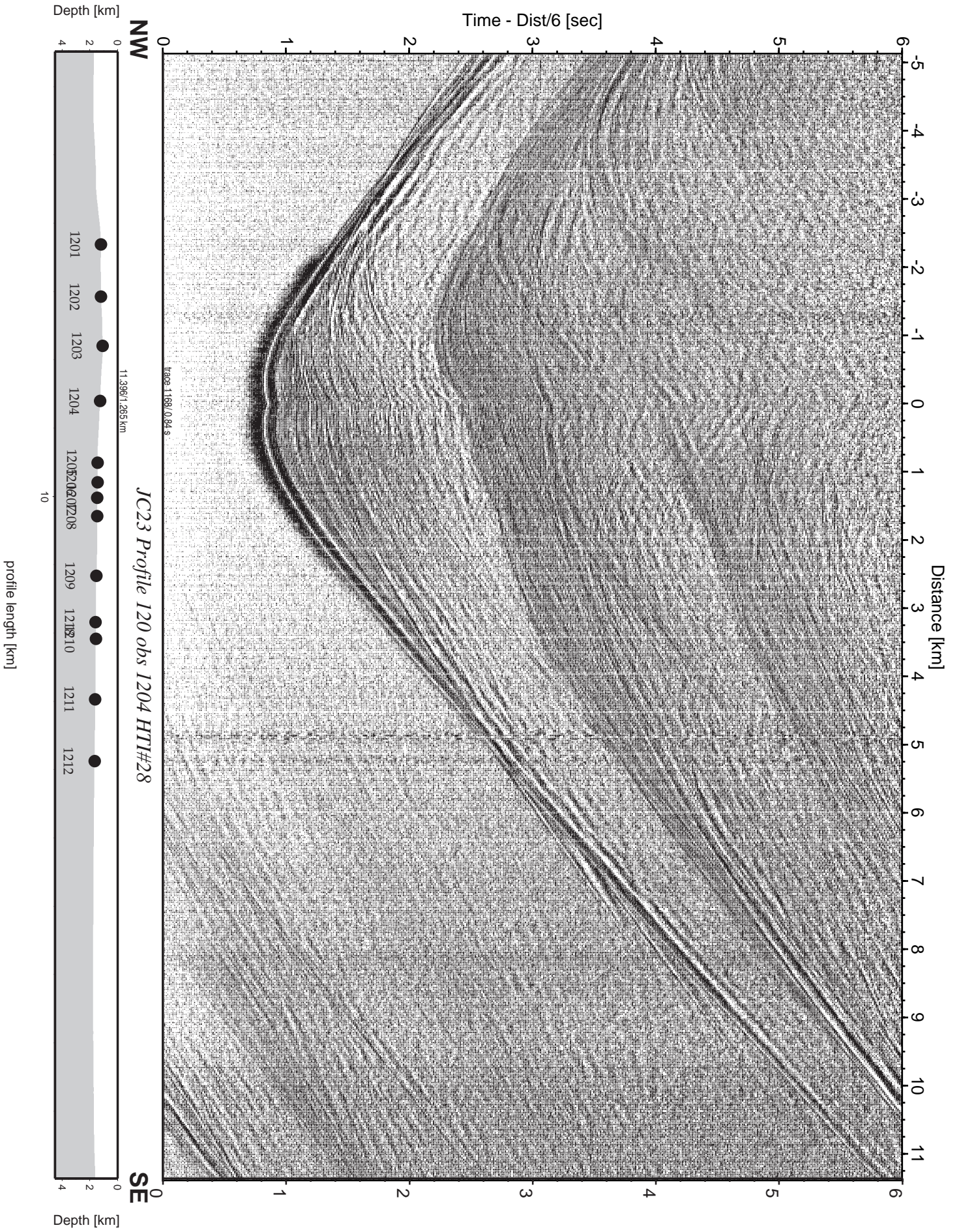

Figure 5.2.9.3 : Record section from obs 1204 HTI#28, Profile 120.

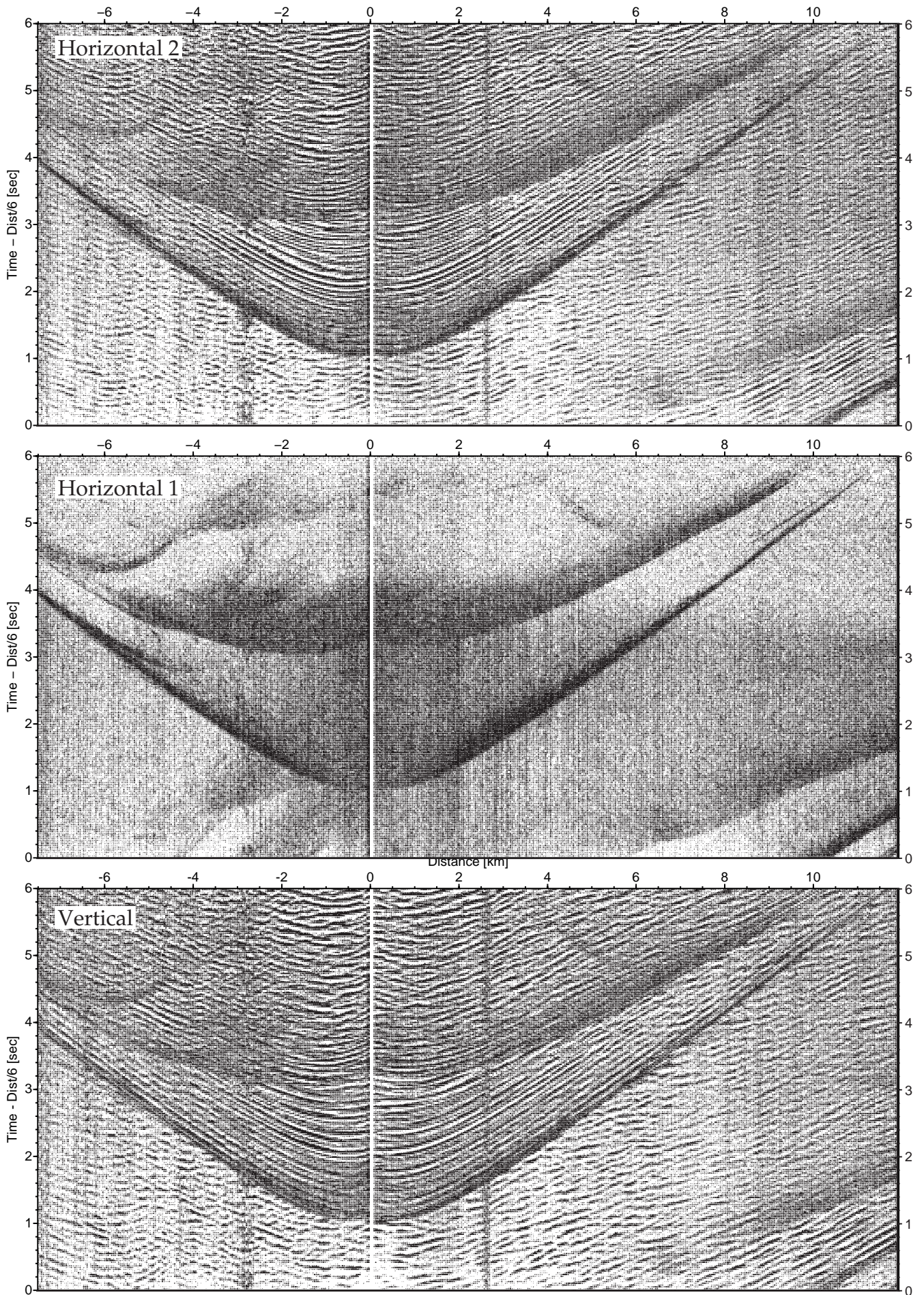

Figure 5.2.9.4: Record sections from obs 1217 (HTI/Owen-4.5Hz Geophone), Profile 124.

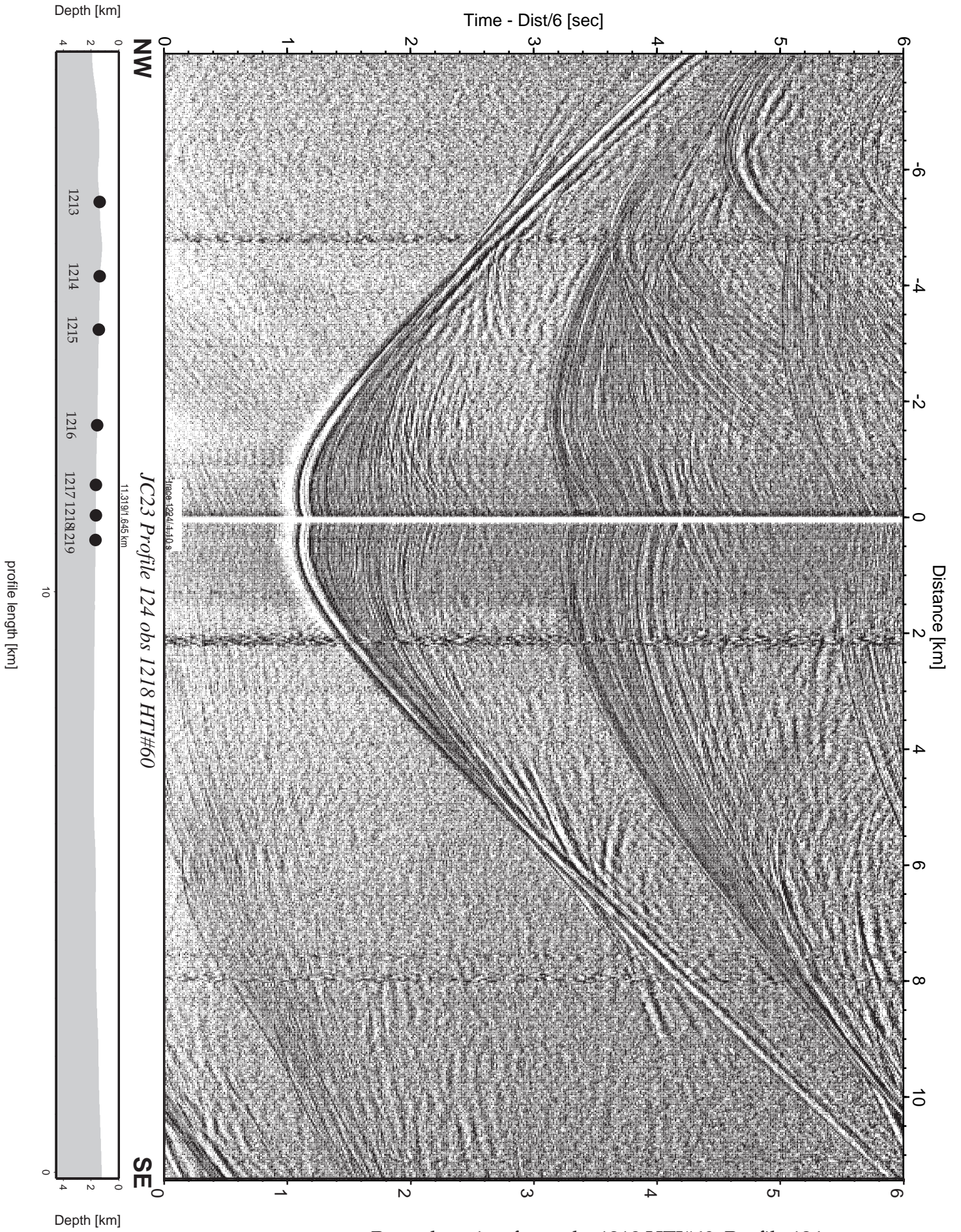

Figure 5.2.9.5 : Record section from obs 1218 HTI#60, Profile 124.

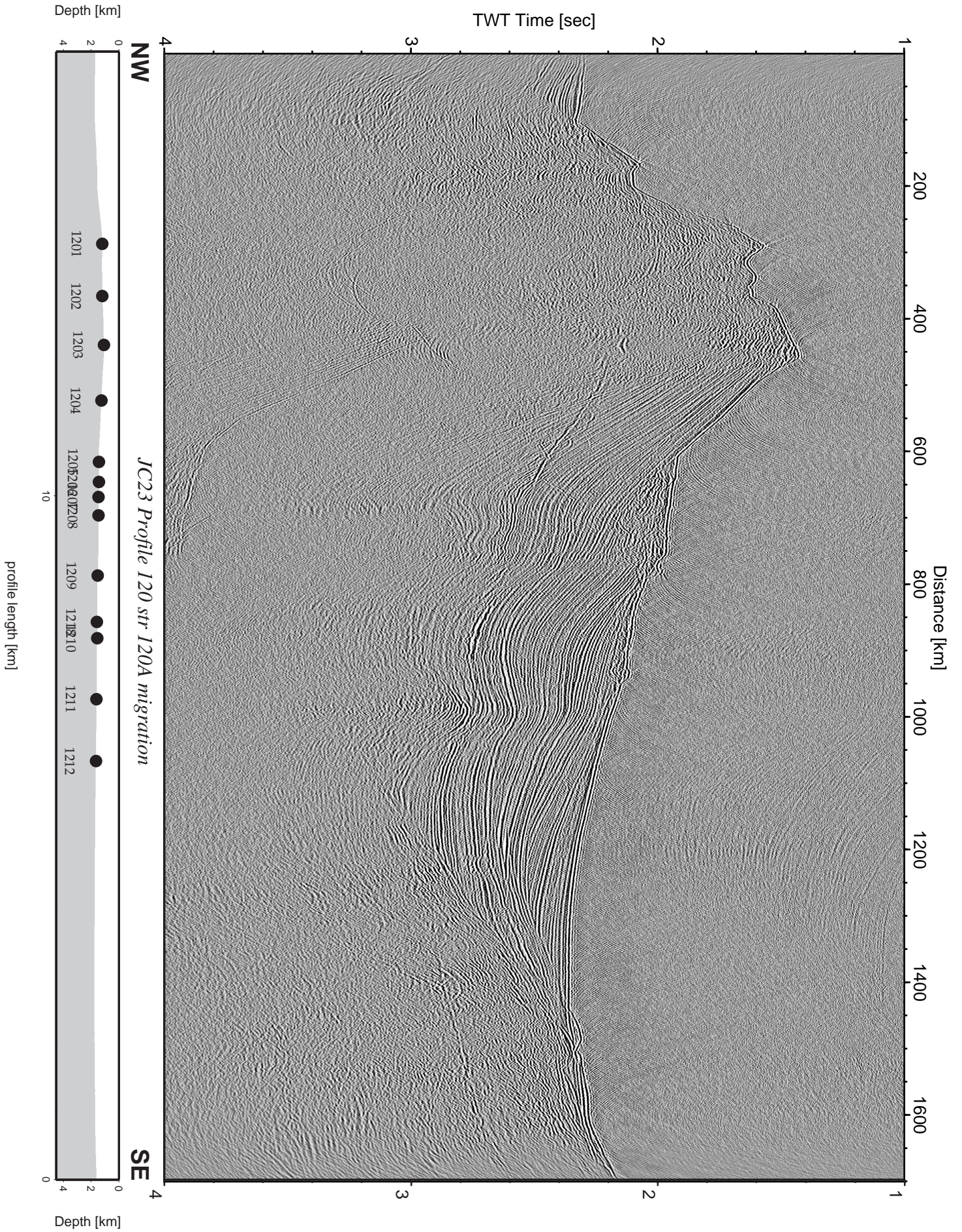

Figure 5.2.9.6 : Record section from str 120A migration, Profile 120.

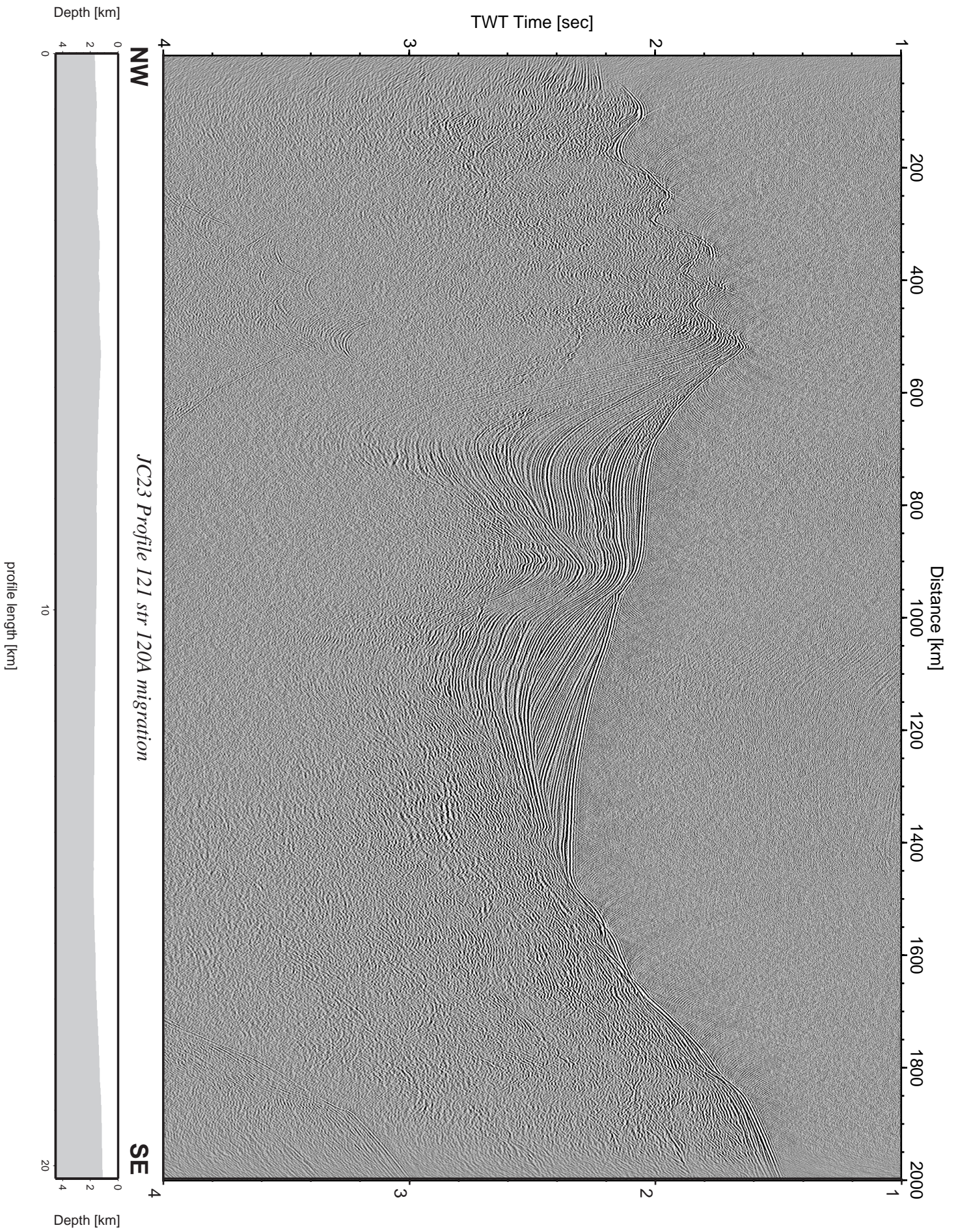

Figure 5.2.9.7 : Record section from str 120A migration, Profile 121.

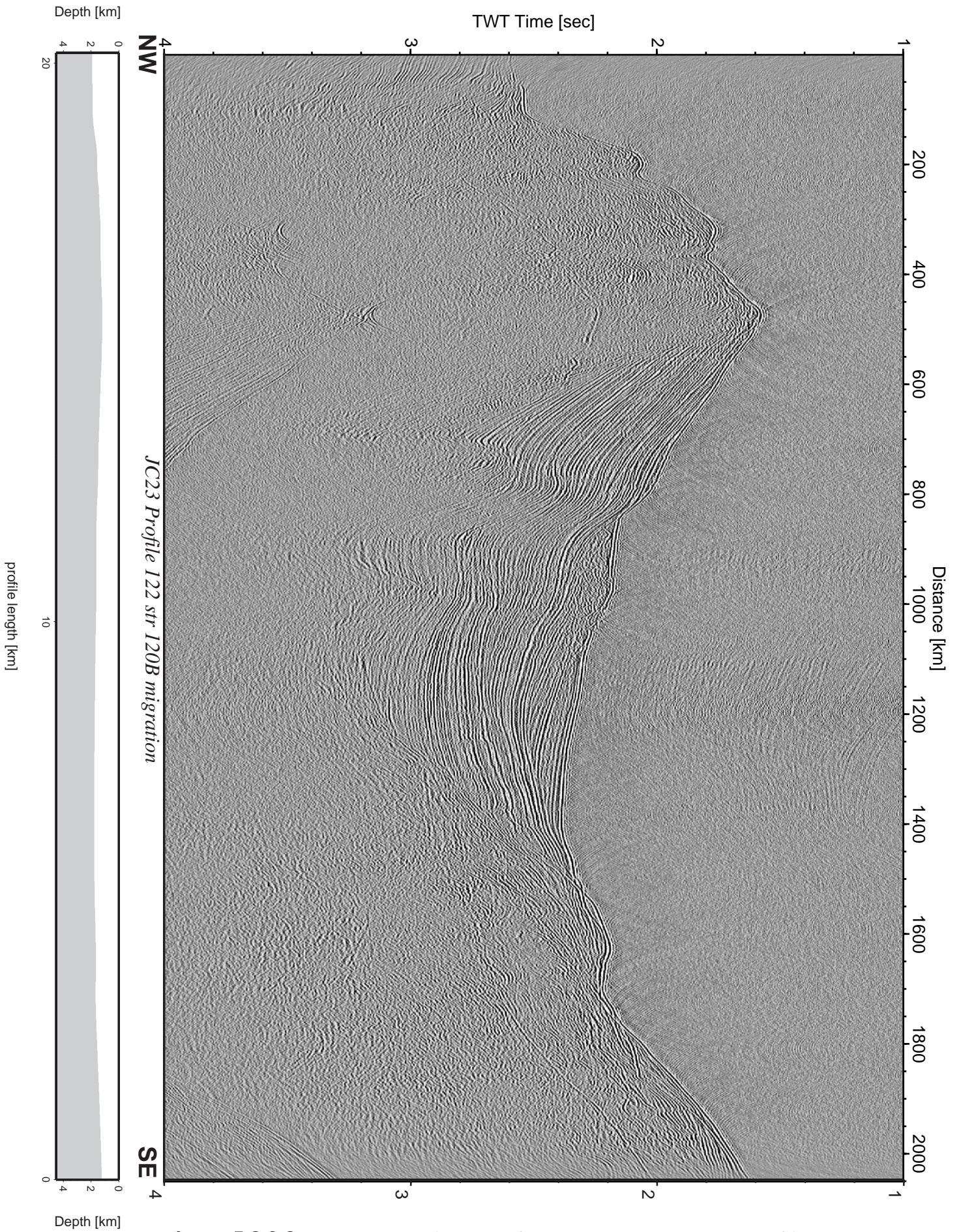

Figure 5.2.9.8 : Record section from str 120B migration, Profile 122.

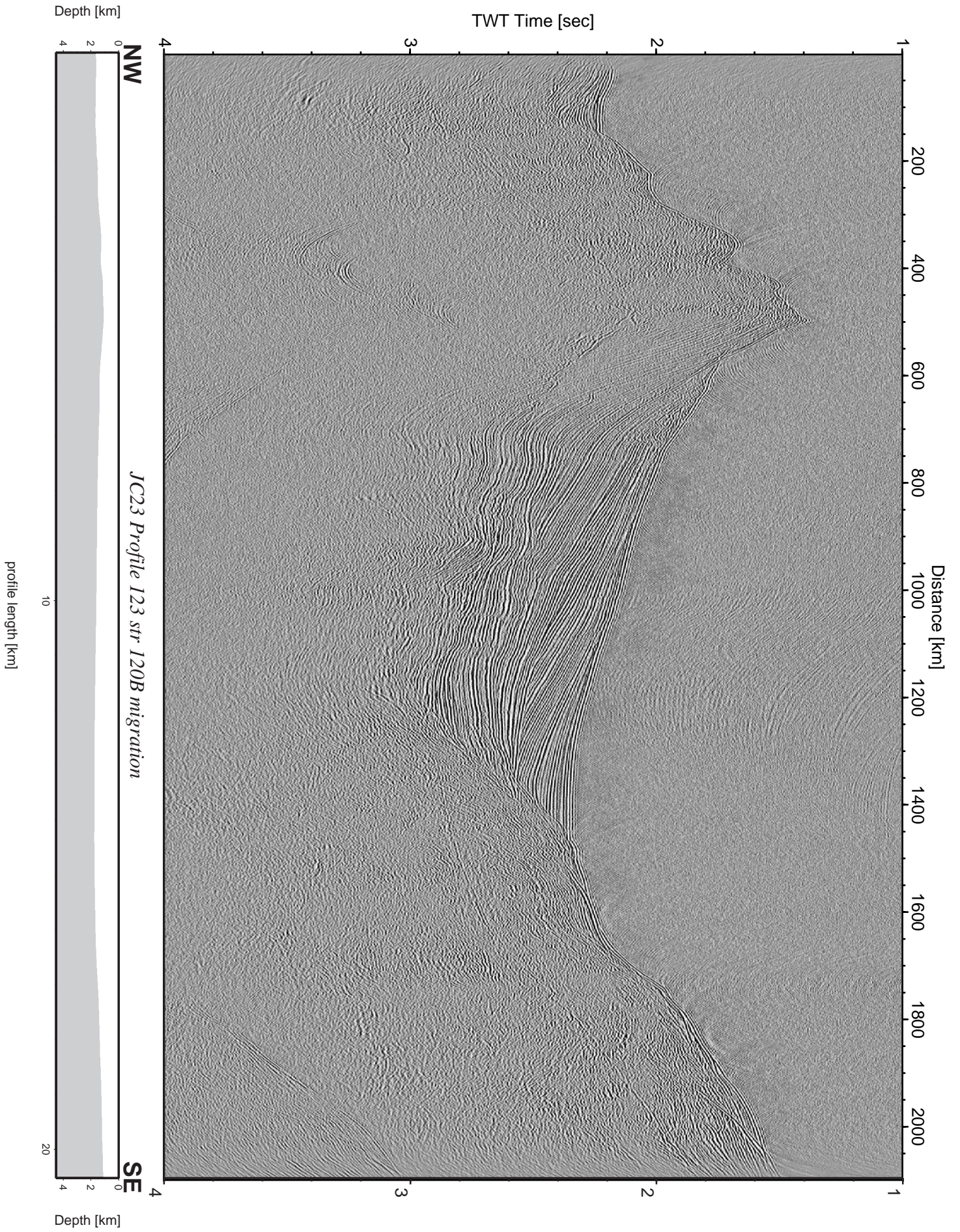

Figure 5.2.9.9 : Record section from str 120B migration, Profile 123.

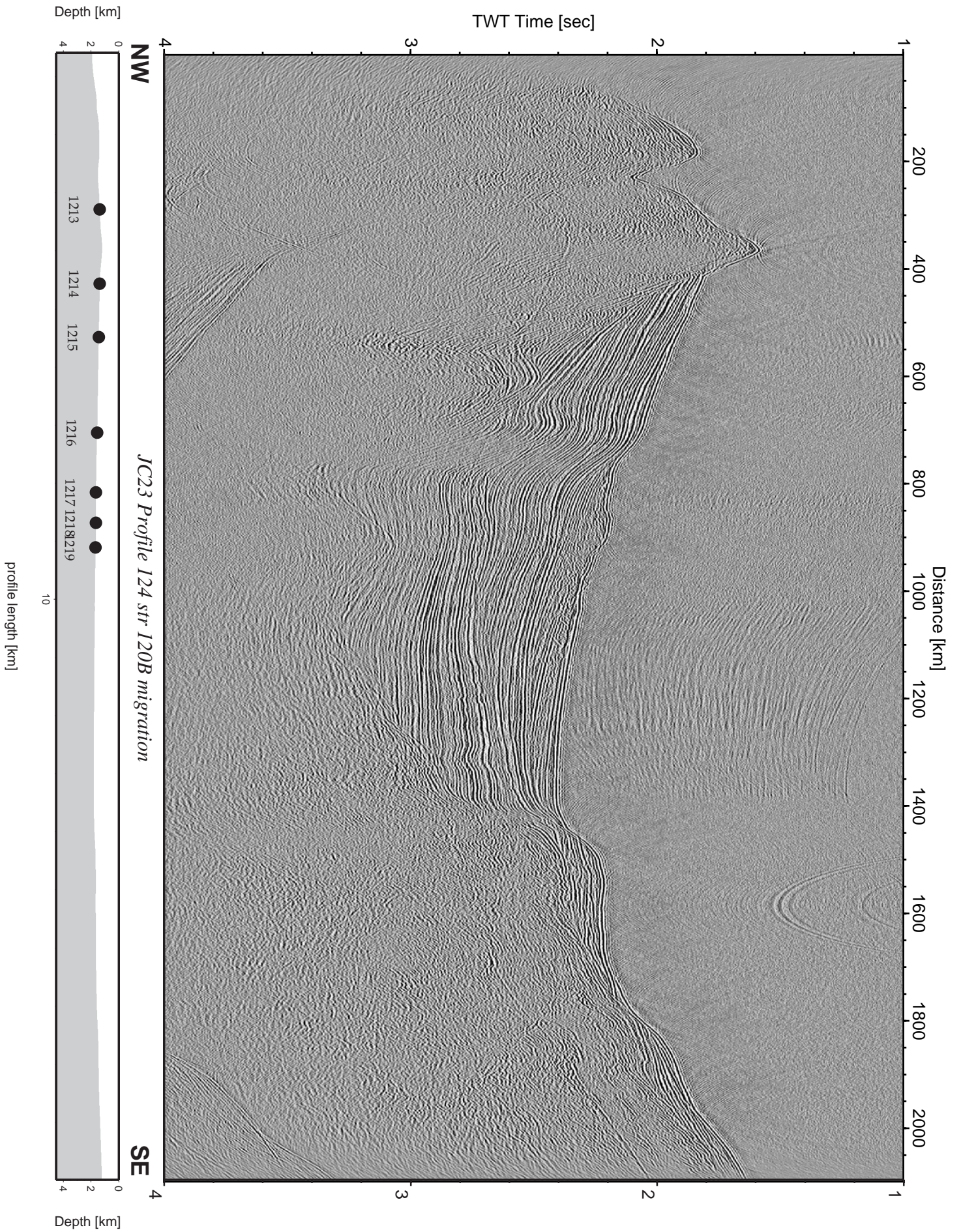

Figure 5.2.9.10 : Record section from str 120B migration, Profile 124.

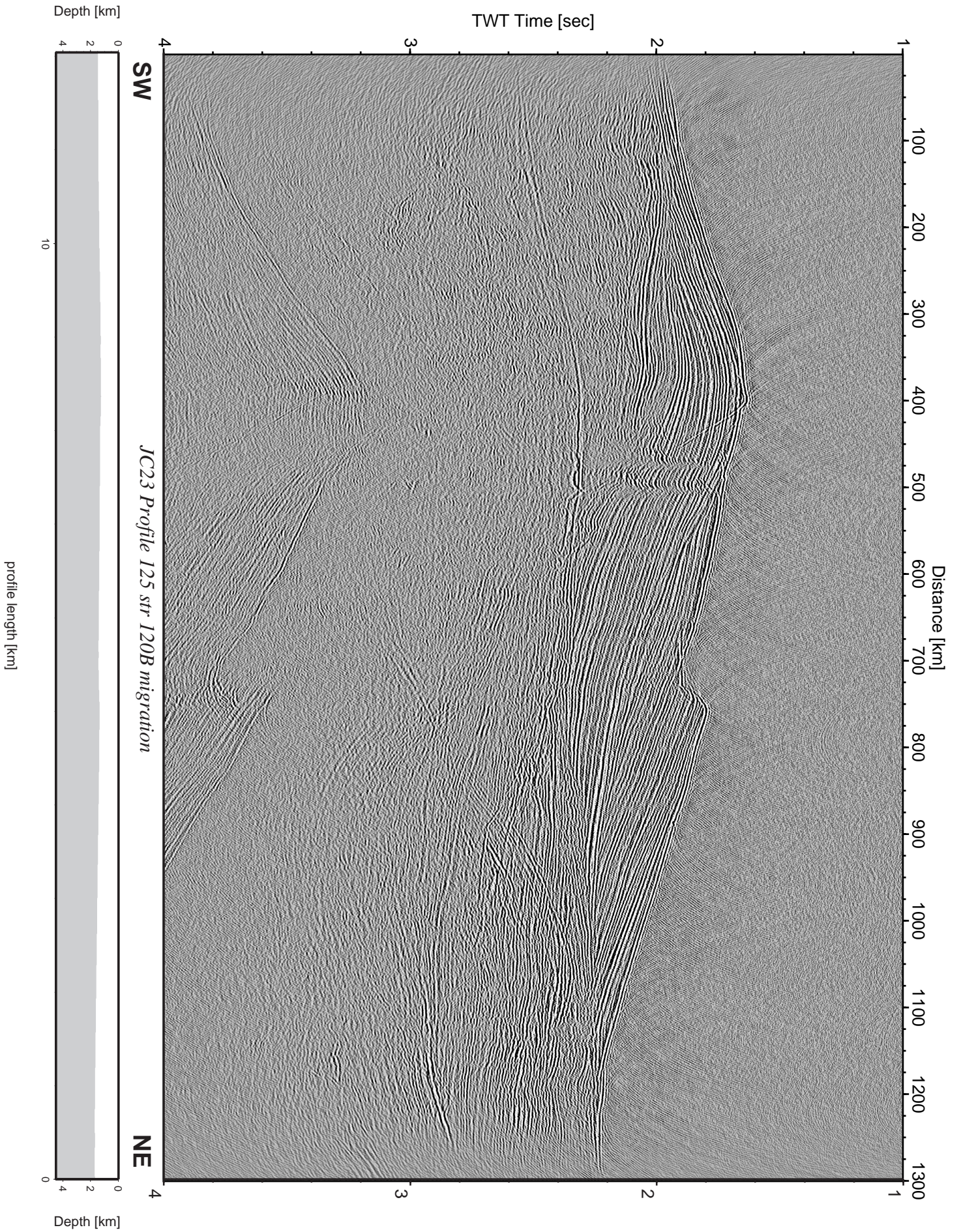

Figure 5.2.9.11 : Record section from str 120B migration, Profile 125.

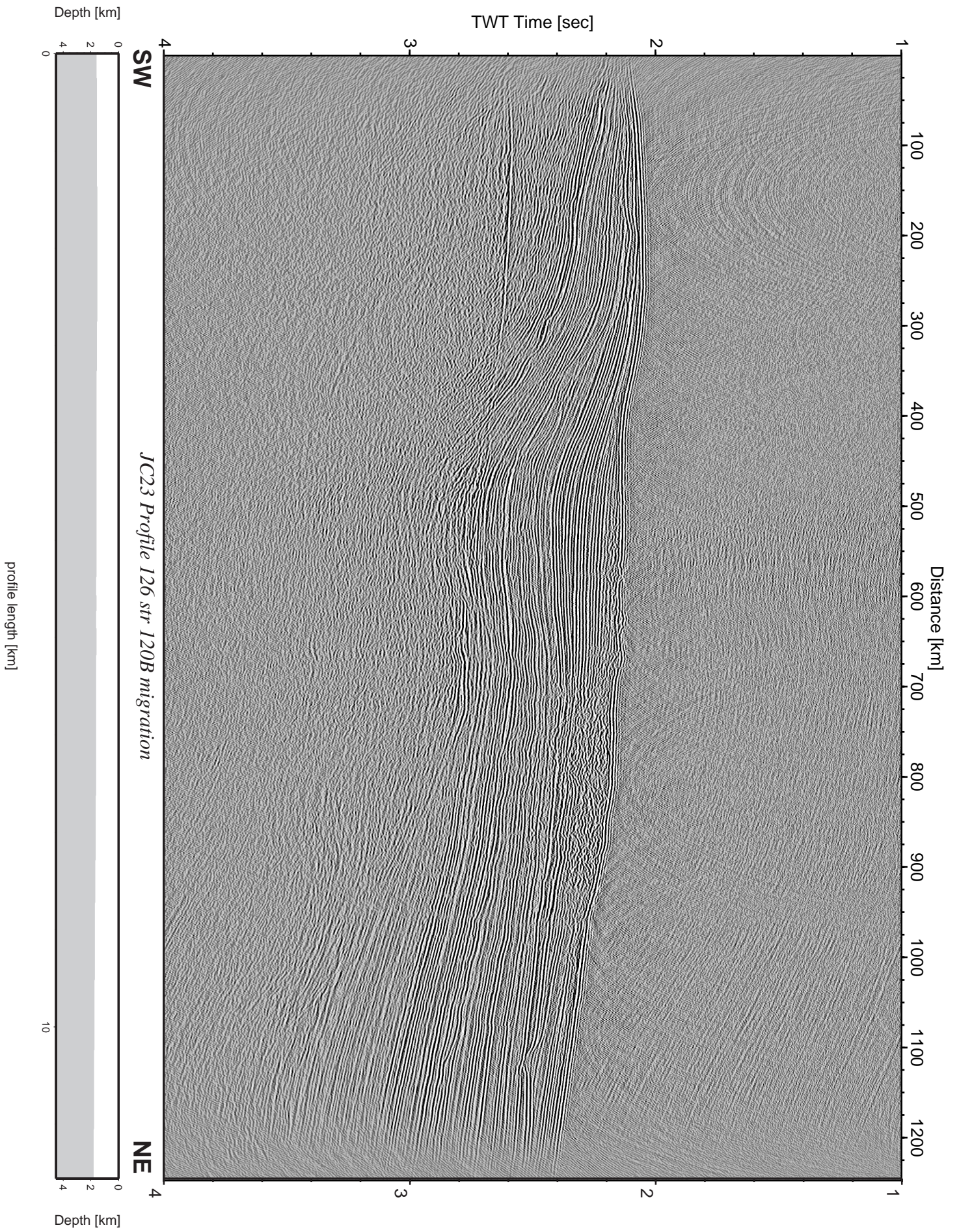

Figure 5.2.9.12 : Record section from str 120B migration, Profile 126.

5.3 Seismic Network

The strong bending of the incoming oceanic plate leads to normal faults (bend-faults) prior to subduction that have been inferred to cut deep enough into the mantle to provide a pathway for seawater. In consequence the “dry” mantle peridotites might be altered to serpentinite (Ranero et al. 2003; Ivandic et al., 2008), which contains up to 13 wt% of water. Dehydration at greater depths (i.e. beneath the volcanic arc) may influence a wealth of subduction zone processes, such as the location of the seismogenic coupling zone (Hyndman & Wang 1993), the melt generation under volcanic arcs (Rüpke et al. 2002) and Wadati–Benioff earthquakes (Meade & Jeanloz 1991; Kirby et al. 1996; Ranero et al. 2005).

Both, teleseismic studies (z.B., Chapple and Forsyth, 1979; Lefeldt and Grevemeyer, 2008) and results from local seismic networks (Grevemeyer et al., 2007; Lefeldt et al., 2008) suggest that bend-faults off Nicaragua cut 10-15 km into the mantle. Multi-channel seismic reflection data allows to image these faults off Nicaragua (Ranero et al., 2003) and Centralchile (Grevemeyer et al., 2005). At the trench-outer rise offshore Nicaragua, seismic wide-angle profiles show reduced P-wave velocities in the upper mantle which are best explained by 10-15% serpentinite (Ivandic et al., 2008).

Off Chile, teleseismically recorded earthquakes reach magnitudes of $M_w \sim 6.8$. However, deployments of local seismic networks have shown that most fault seems to continuously active, at magnitudes well below the global detection threshold of $M_w > 4.5-5$ (Grevemeyer et al., 2007; Tilmann et al., 2008).

Thus, a seismic shortterm network (Fig. 5.3.1) consisting of 16 short-period Oceanbottomseismometers (OBS) in addition to 10 Broadband-OBS was installed during Leg 1, basically with two aims (i) sampling local earthquakes for the study of trench-outer rise earthquakes, their distribution with respect to epicentre location and depth, and fault mechanisms (ii) collecting regional and teleseismic earthquakes for joint travel time inversion to yield the 3-dimensional velocity field down to a depth where mantle velocity returns from reduced values caused by serpentinitization to normal background velocity. Therefore, active and passive source seismic data will be jointly inverted using the Fast Marching Tomography Package (FMTOMO) of N. Rawlingson, developed at the Australian National University (Rawlingson et al., 2006; Rawlingson and Urvoy, 2006). Like for the active source data, we aim to derive the amount of chemically-water bound in the mantle, to be carried into the deep subduction zone.

Thus, if reduced mantle velocities can be observed, analysing b-factors of momentmagnitudes of local earthquakes may provide an answer whether with is due to mantle serpentinitization or fracture porosity (Lefeldt et al., 2008), since serpentinitization causes a significant drop in the strength of the lithosphere.

The shortterm network will be recovered and replaced by a longterm network during Leg 2 (Fig. 5.3.1). In combination with short-period and broadband landstations, the focus of this experiment is the seismogenic zone and should provide information about the degree of hydration of the mantle wedge. Next to the described tomographic inversion with FMTOMO, recordings from this network will be used as well for receiver function analysis. Receiver functions (e.g., Vinnik, 1977) are perhaps best being studied along transects. Receiver functions are isolated *P* to *S* converted waves from seismic velocity contrasts below a seismic station. Deconvolution removes the effects of the source and of the wave propagation prior to

P to S conversion. The Moho phase is generally clearly seen in the data. Moho multiples can be used to determine the Poisson's ratio ν and crustal thickness z for each station. (e.g., Zhu and Kanamori, 2000). This technique involves a grid search over the Poisson's ratio and Moho depth to determine the (ν, z) pair which best fits the observed waveforms. In addition, waveform modelling can be used to determine the velocity contrast at the Moho and hence the nature of the uppermost mantle wedge.

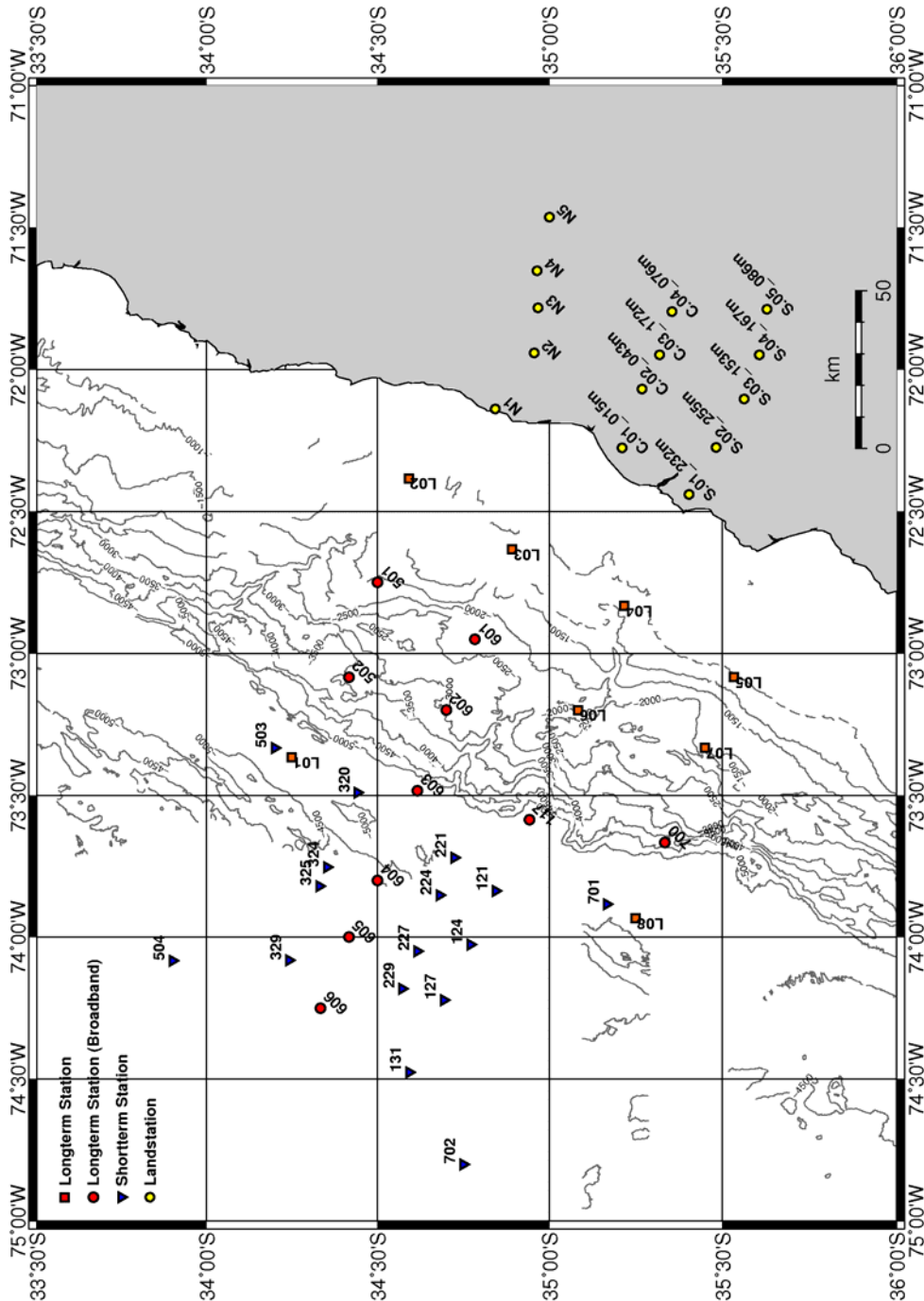

Figure 5.3.1: *Marines short- and amphibic longterm network. The shortterm network was installed from early March to middle April 2008, the longterm network will be deployed from middle April to October/November 2008, respectively broadband stations from early March as well.*

5.4. Sub Bottom Profiler

Technical description

The SBP 120 Sub Bottom Profiler is an extension of the EM 120 Multibeam echo sounder. The system uses the same receive transducer hydrophone array, which are wideband. By adding a separate low frequency transmit transducer and appurtenant electronic cabinets and operator units, the EM 120 can be extended to include the sub-bottom profiling capability provided by the SBP 120. The SBP 120 has significantly reduced beam widths compared to conventional sub-bottom profiles. This is obtained by one linear transmitter array mounted along the vessel keel, and one linear hydrophone array (shared with the EM 120) mounted orthogonal to the keel. The footprint of the transmitter array is wide across track and narrow along track, whereas the opposite is the case for the receiver array. The combined beam pattern of the two arrays is a narrow beam.

Because the transmit beam is wide across track and all hydrophones are sampled individually, the SBP 120 can make a fan of narrow beams across track per ping. This capability is useful for finding the specular returns in rough terrain and for obtaining information about sloping angle of sediments.

The transmitted waveform is a linear chirp. The outer limits for the start and stop frequencies of the chirp are 2.5 and 7.5 kHz, respectively, providing a maximal vertical resolution of approximately 40 cm. The used system was a three degree system, meaning that opening angles of individual beams are 3°. In general we recorded a fan of three beams. The beams are electronically stabilized for roll and pitch. Some problems, with the heave compensation, however, occurred during the cruise. These problems could be usually resolved by a restart of the program.

The system was operated in a burst mode. A number of pulses were transmitted before the first return. This option allows a much higher ping rate compared to the 'normal' mode, where the SBP 120 pings once and then waits to collect the return signal. The so called bottom tracker is used for finding and detecting the sea floor. Based on this depth the recording delay can be set automatically. The depth detection with the bottom tracker, however, was not very reliable, and hence the recording delay was chosen by the watch keeper.

The recording window was set to 500 ms. Unprocessed data were recorded in SEG-Y format. The system worked very reliable except for occasional problems with the heave compensation (see above). Data quality is significantly reduced when using the bow thrusters and when heading against the waves due to air bubbles beneath the ships keel.

First results

The sub bottom profiling system was always used when the ship was moving, i.e. during transits, seismic profiling, and deep-tow surveys. Some features were investigated especially with the bathymetric multibeam system and the sub bottom profiler alone. A number of typical examples are shown in the following.

A major target of the cruise was to detect seep sites in various water depths. Two areas with promising evidence for seep sites were surveyed with the deep-tow sidescan sonar. The first area (P10, chapter 5.2.7, 10.) is located between 35°40'S and 36°10'S in water depths ranging from 800m - 1800m (Fig. 5.4.1). Unfortunately no clear evidence for seepage was identified in this area. The variable sea floor shows sections with well stratified sediments, divergent

reflection patterns, small slide deposits, turbiditic channels, hummocky reflection patterns, and several steep escarpments.

A few examples of this area are shown in Figs. 5.4.2 to 5.4.5

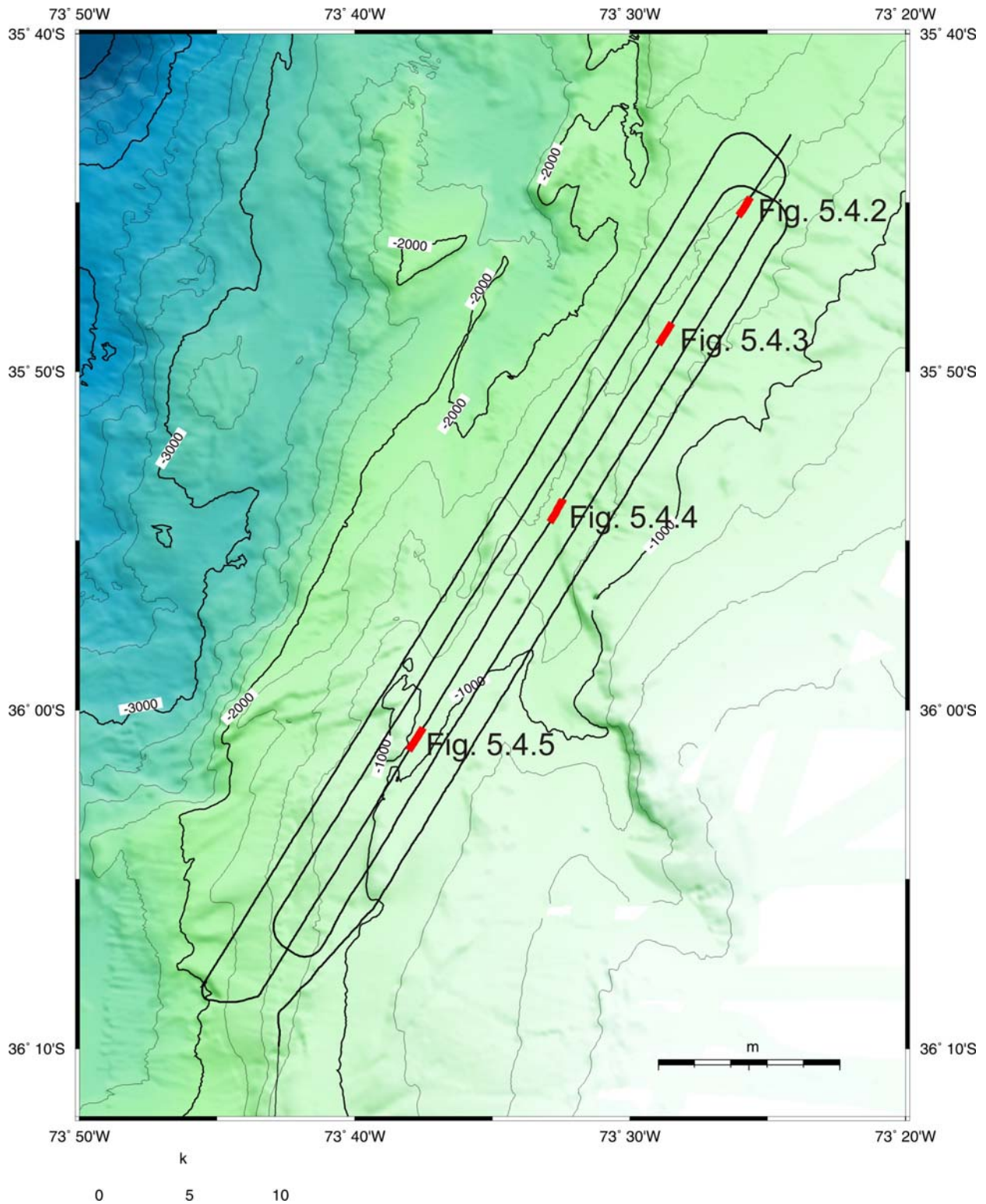

Fig. 5.4.1: Sidescan sonar tracks in an area between 35°40'S and 36°10'S. Locations of examples shown in Figs. 5.4.2 to 5.4.5 are marked as thick lines.

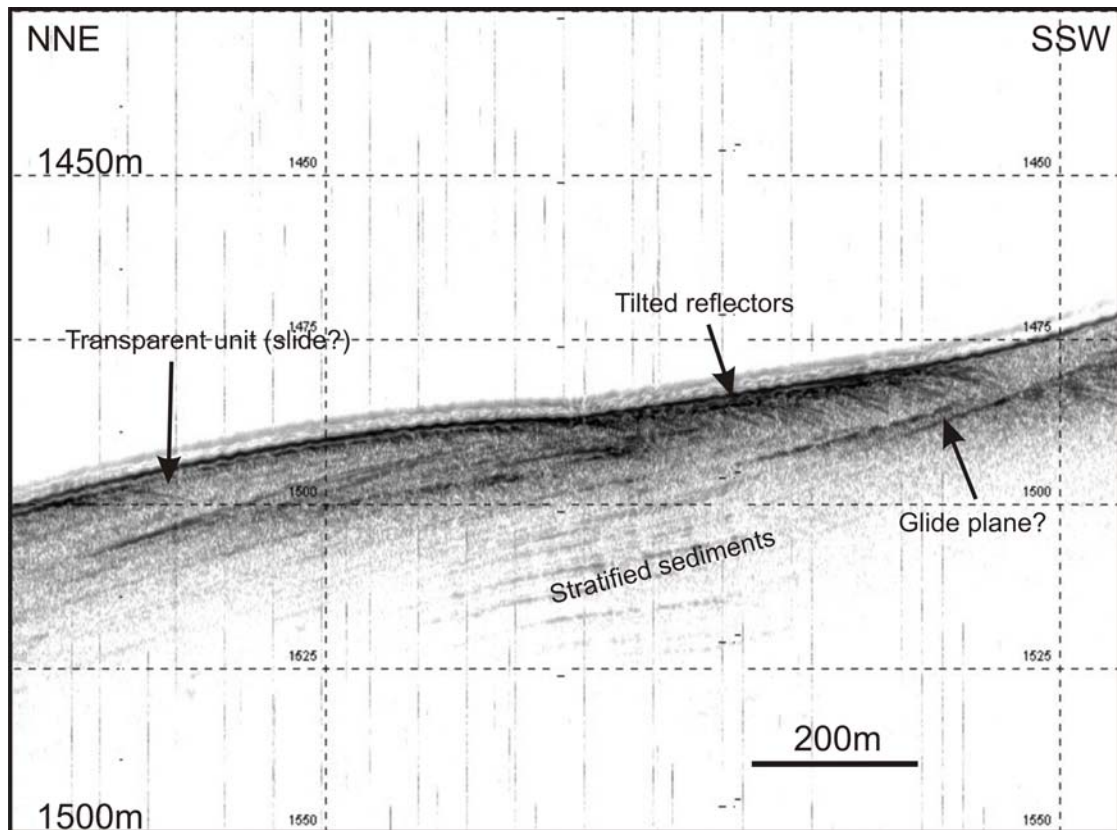

Fig. 5.4.2: Sub bottom profiler data showing transparent units and tilted reflectors on top of stratified reflectors. The transparent and tilted reflectors most likely belong to a small slide body. A possible glide plane is visible as prominent reflector. See Fig. 5.4.1 for location of profile.

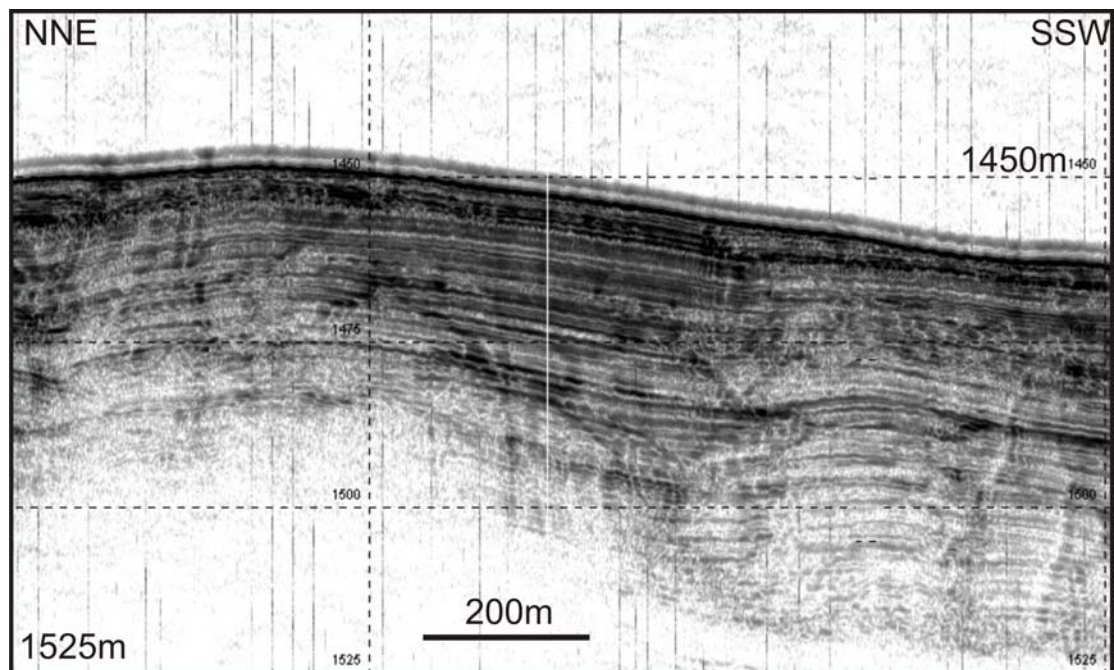

Fig. 5.4.3: Sub bottom profiler data showing slightly deformed stratified sediments. Some small amplitude variations might indicate a varying fluid content of the sediments. See Fig. 5.4.1 for location of profile.

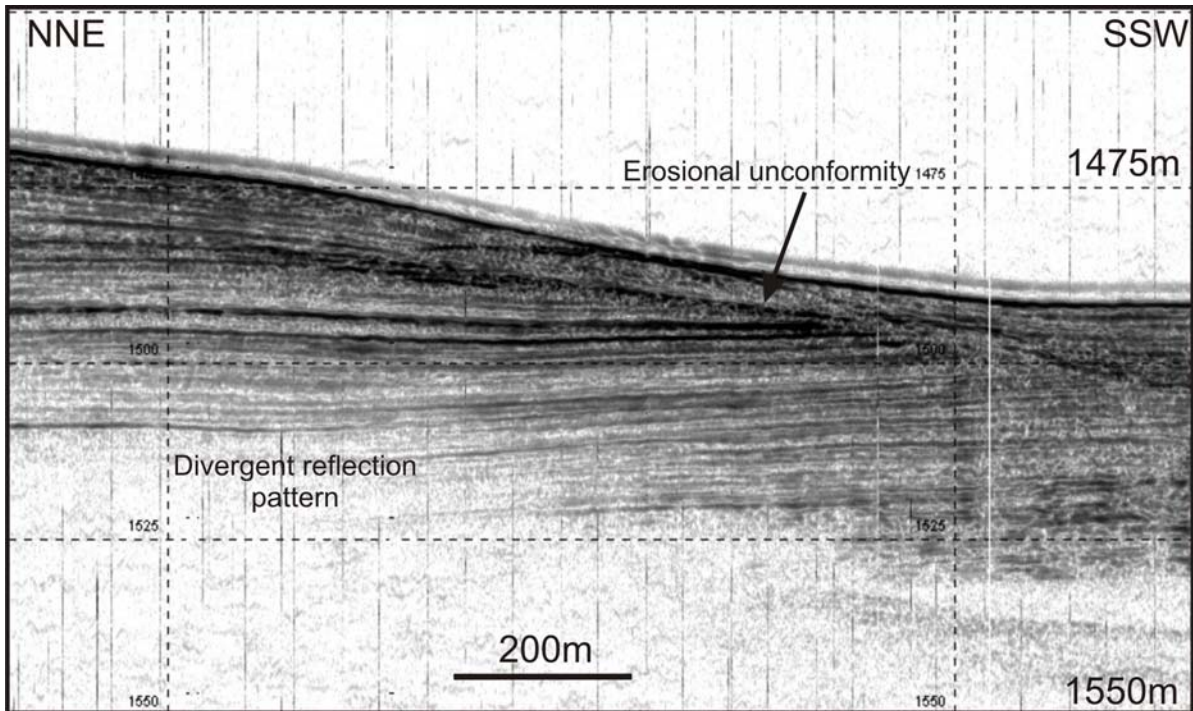

Fig. 5.4.4: Sub bottom profiler data showing a thin (<5m) sedimentary cover on top of an erosional unconformity. The sediments beneath the erosional unconformity are showing a slightly divergent reflection pattern. The erosional unconformity is most likely formed by strong bottom currents. See Fig 5.4.1 for location of profile.

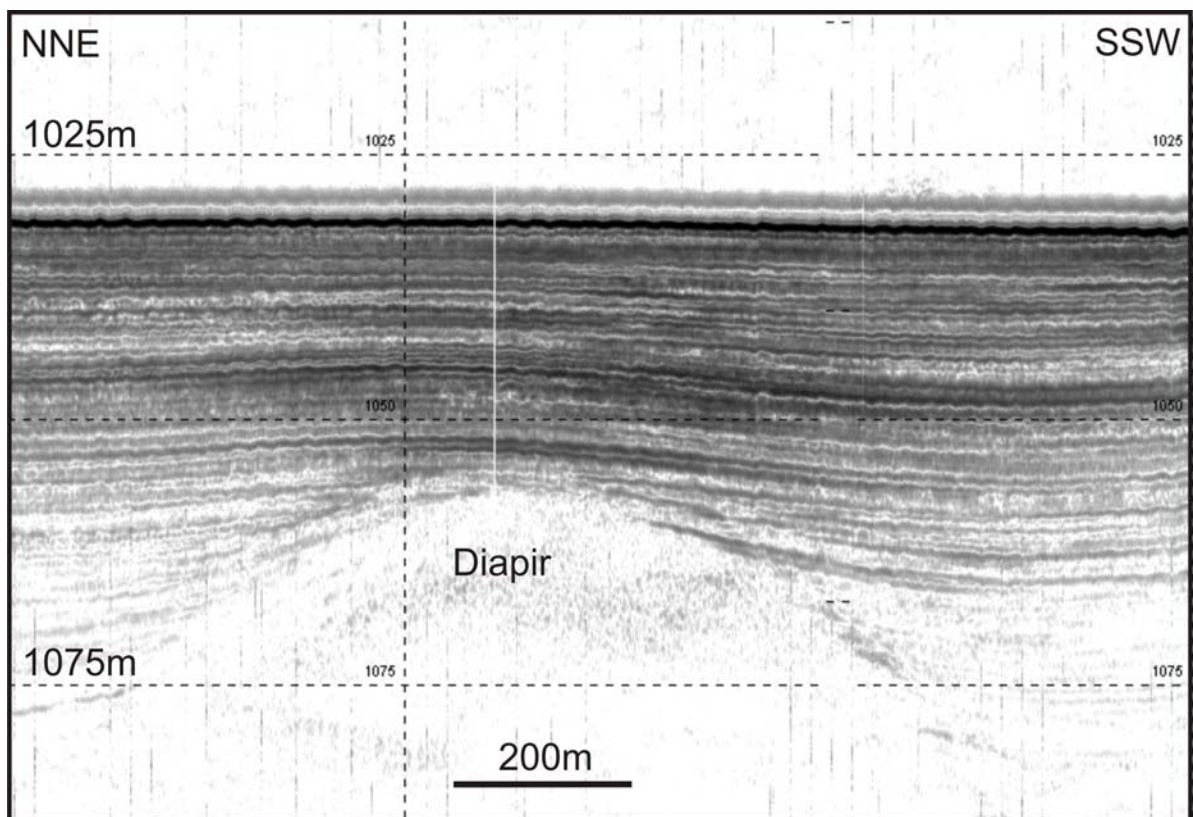

Fig. 5.4.5: Sub bottom profiler data showing a diapiric structure beneath well stratified sediments. See Fig.5.4.1 for location.

A second area for a deep-tow sidescan survey (P11, see chapter 5.2.8 & 10) was located south of the area described above between $36^{\circ}15'S$ and $36^{\circ}35'S$ in water depths around 1000m. Several small isolated highs were identified in this area on bathymetric maps. Various mound structures were identified in this area. Some examples of these mounds are shown in Figs. 5.4.7 to 5.4.9.

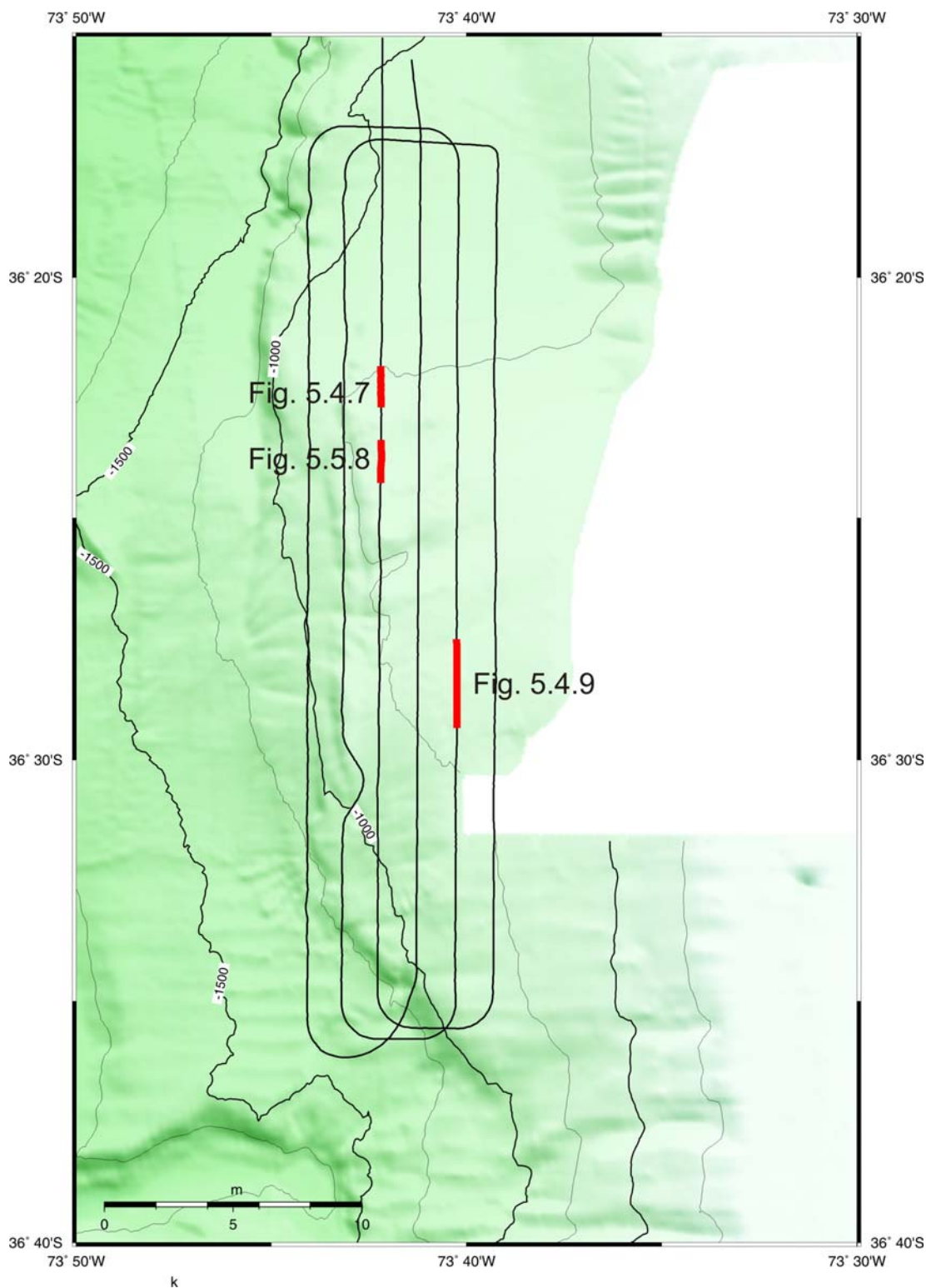

Fig. 5.4.6: Sidescan sonar tracks in an area between $36^{\circ}15'S$ and $36^{\circ}45'S$. Locations of examples shown in Figs.5.4.7 to 5.4.9 are marked as thick lines.

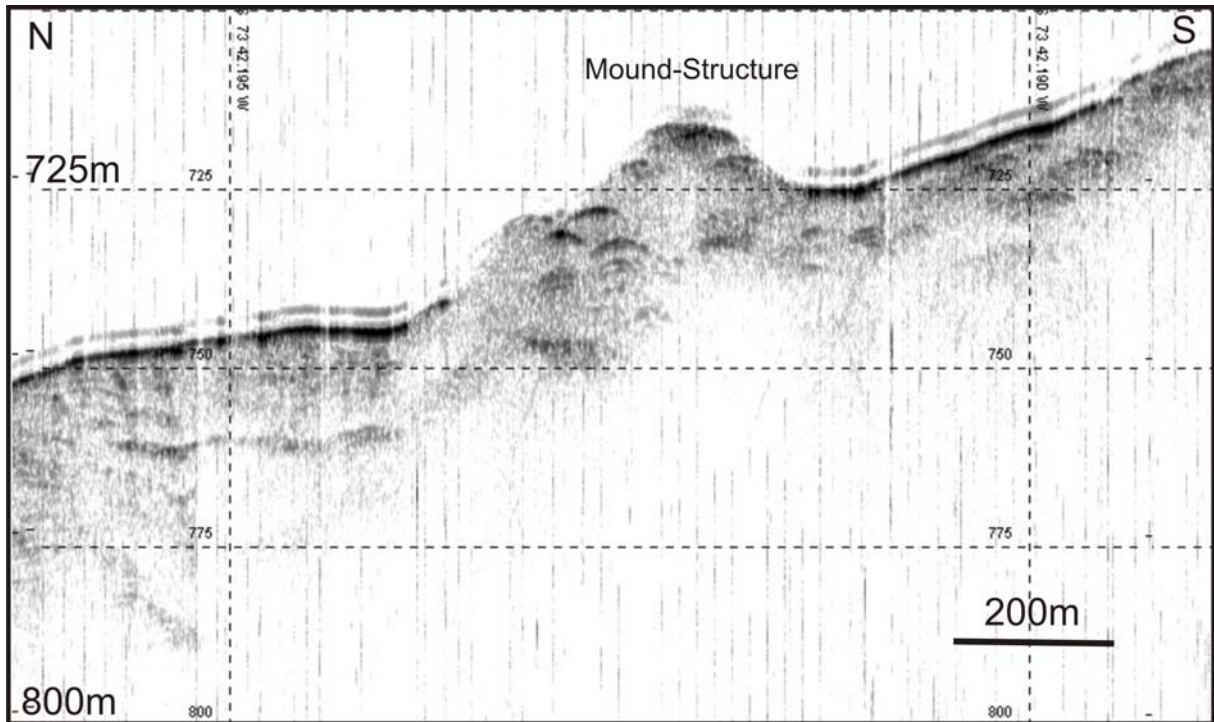

Fig. 5.4.7: Mound structure at approximately $36^{\circ}22.3'S$, $73^{\circ}42.2'W$. This structure has a diameter of $\sim 400m$ and a height of $\sim 20m$ above the surrounding sea floor.

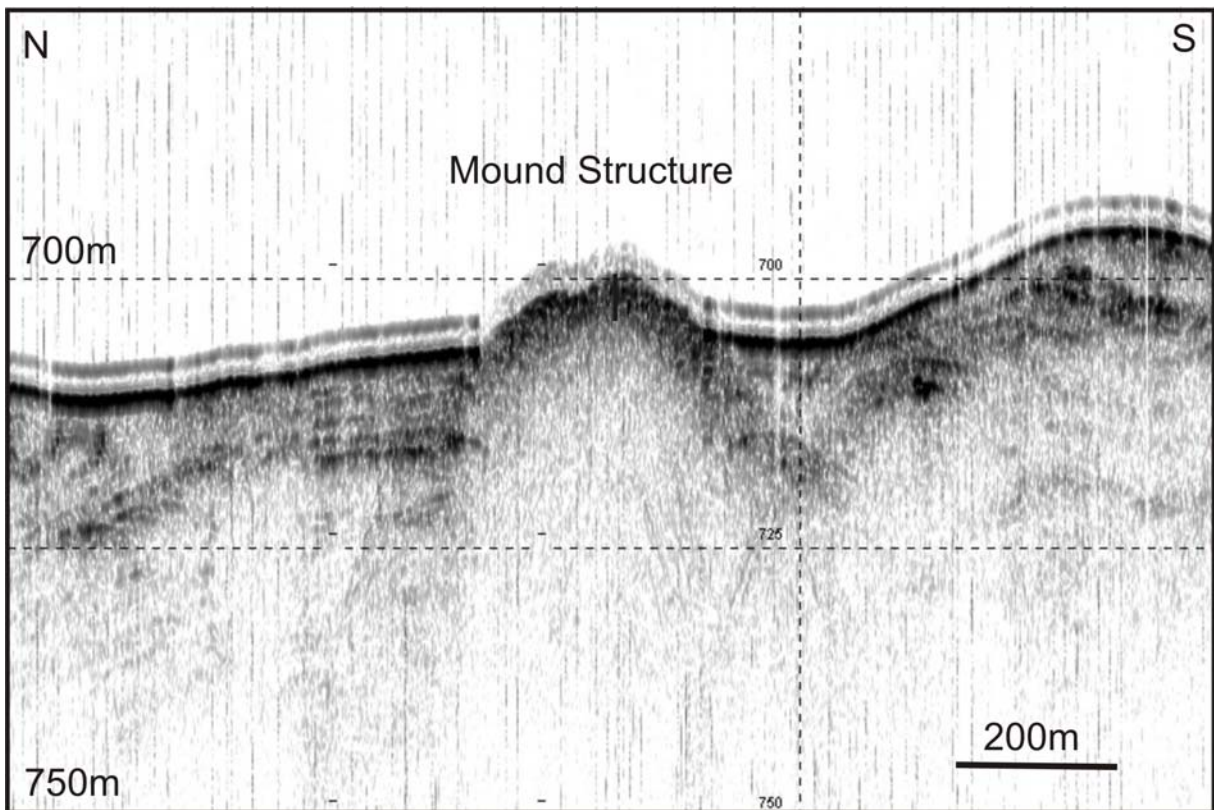

Fig. 5.4.8: Mound structure at approximately $36^{\circ}23.9'S$, $73^{\circ}42.2'W$. The diameter of this structure is $\sim 200m$. The height of this feature is less than $5m$ on this profile. No reflectors can be identified beneath the mound structure.

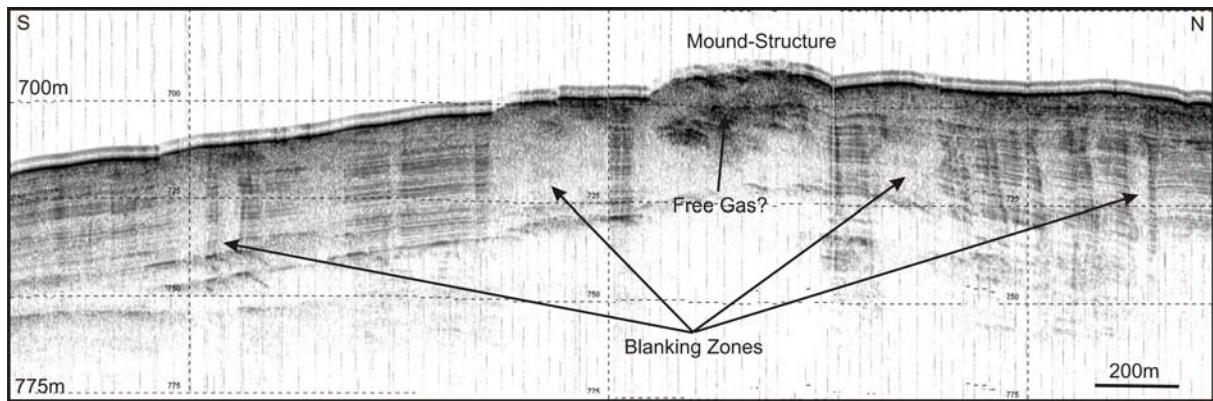

Fig. 5.4.9: Mound structure at approximately $36^{\circ}28.1'S$, $73^{\circ}40.2'W$. This structure has a diameter of $\sim 400m$ and a height of $\sim 10m$. A strong reflector beneath the mound might indicate the occurrence of free gas. The mound structure is surrounded by well stratified sediments which show some blanking zones. These blanking zones can be caused by attenuation of the signal due to free gas or might represent small diapirs.

Two major slides were surveyed during cruise JC23b. The first slide is located at the lower most continental slope (Fig. 5.4.10, P09, see chapter 5.2.6). The headwall is almost 200m high and is too steep to be imaged with the SBP 120. The depositional part of the slide consists of several mega blocks of several 100 meters height. The sub bottom profiler data were used to characterize the slide deposits and to select sampling sites. Examples of the sub bottom profiler data are shown in Figs. 5.4.11 to 5.4.13.

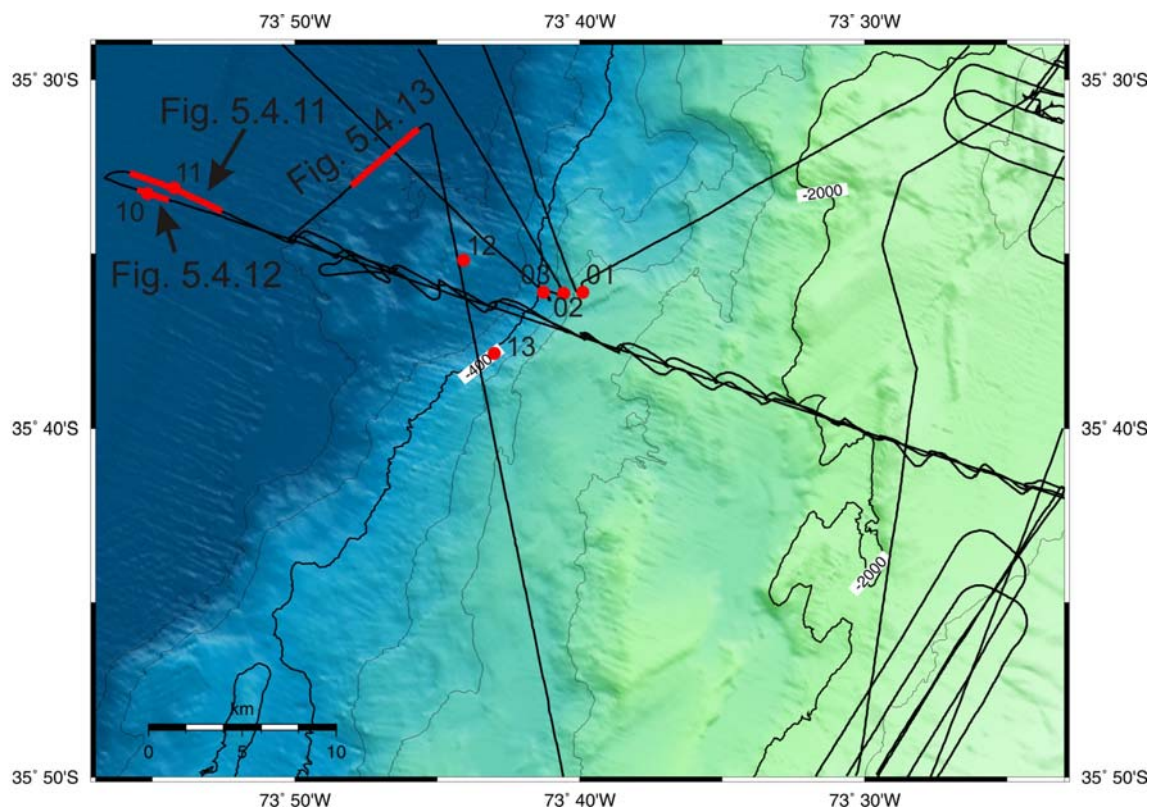

Fig. 5.4.10: Track chart and core locations across a major slide at lower continental slope. Locations of examples shown in Figs. 5.4.11 to 5.4.13 are marked as thick lines.

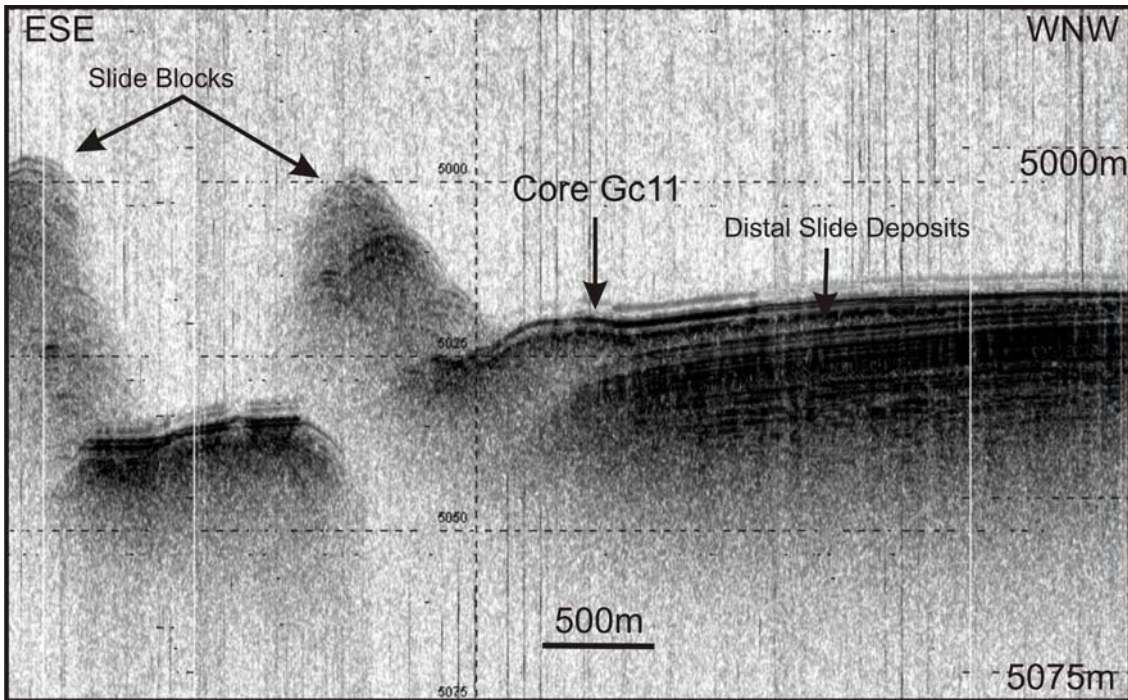

Fig. 5.4.11: Sub bottom profiler data across the distal edge of the slide shown in Fig. 5.4.10. The distal edge of the slide is imaged as thin transparent unit. The sub bottom profiler data suggest a thin cover (<2m) on top of the slide deposits. Two blocks each ~ 25m high are imaged at the eastern part of the profile. See Fig. 5.4.10 for location of profile.

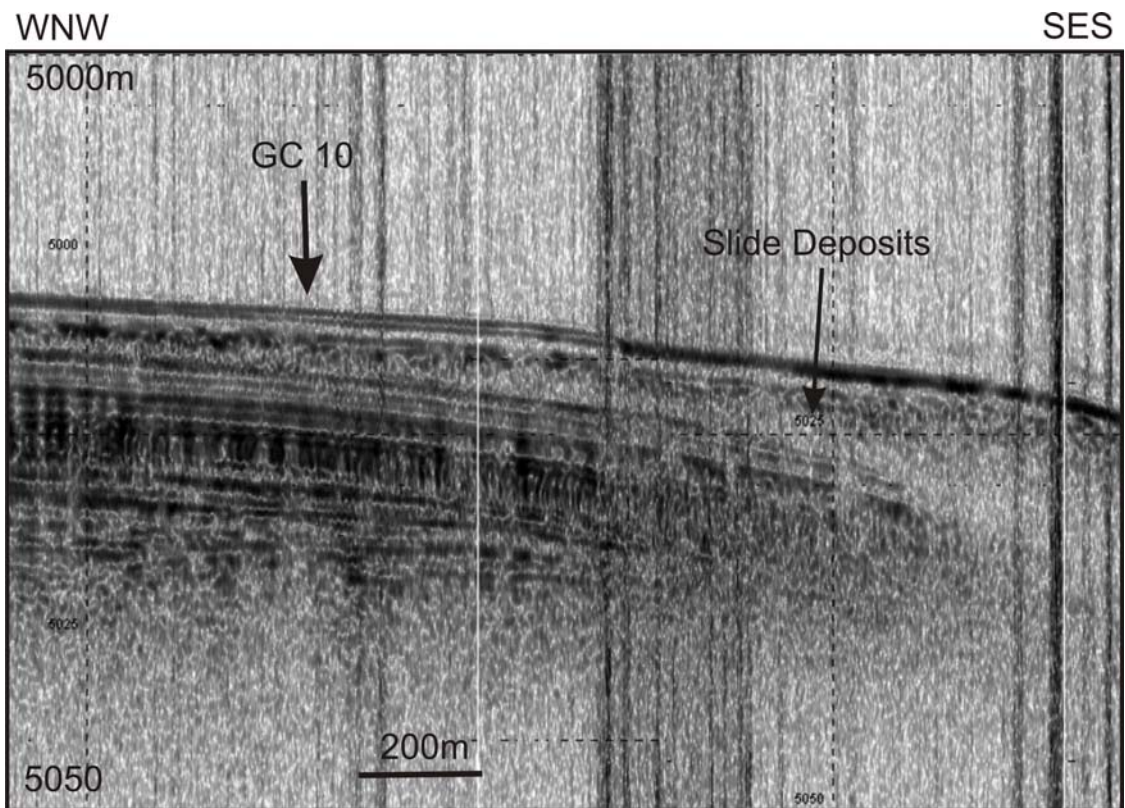

Fig. 5.4.12: Sub bottom profiler data across the distal edge of the slide shown in Fig. 5.4.10. This profile is in direct vicinity to the profile shown in Fig. 5.4.11 but has a better lateral resolution caused by a lower ship speed. The distal edge of the slide is imaged as transparent unit. See Fig. 5.4.10 for location of profile.

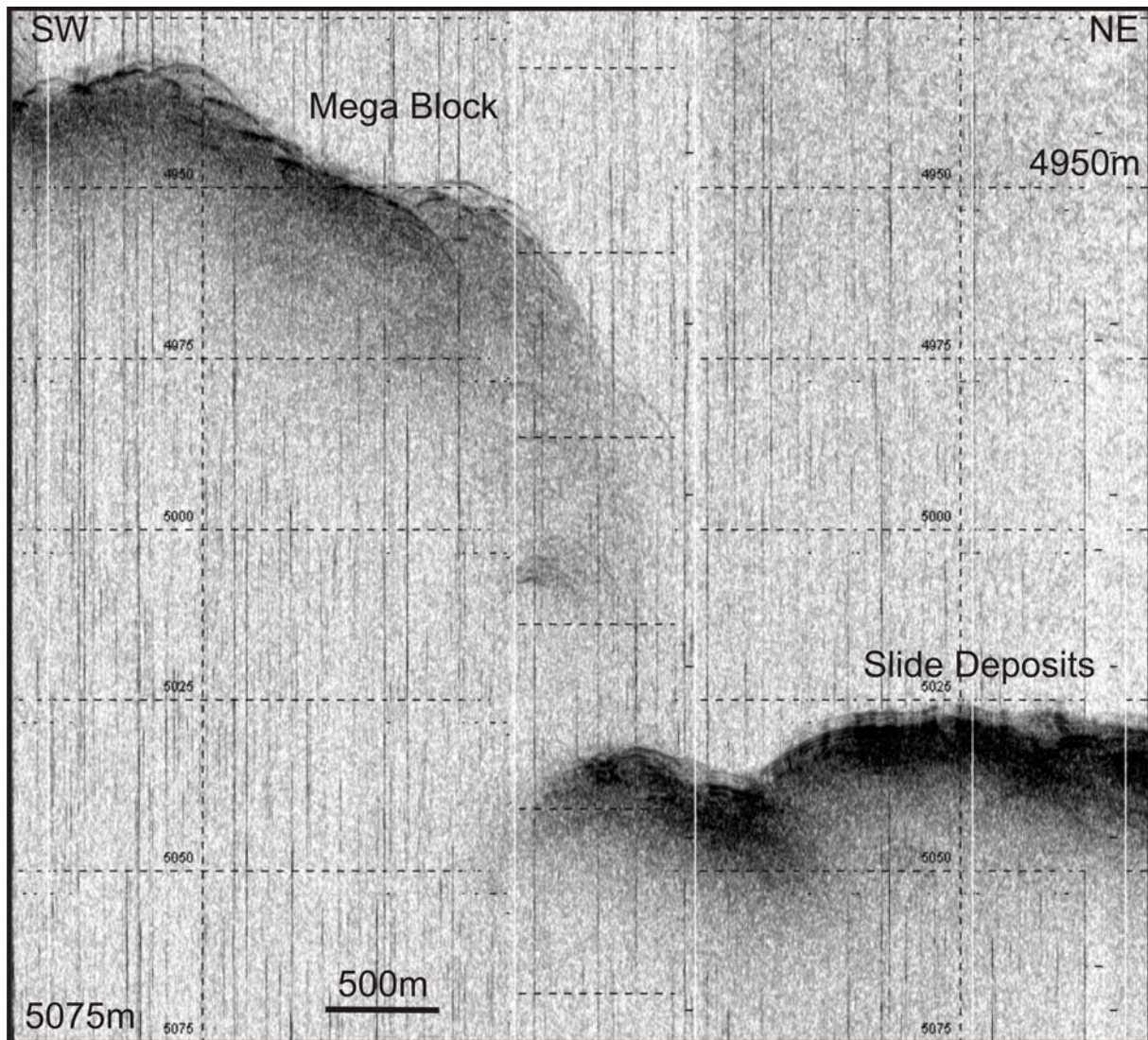

Fig. 5.4.13: *Sub bottom profiler data across a mega block of the slide shown in Fig. 5.4.10. This block has a height of ~ 100m. See Fig. 5.4.10 for location of profile.*

A much smaller slide in a middle slope location (P12, see chapter 5.2.9 & 10) was surveyed with sidescan sonar, seismic and sub bottom profiler (Fig. 5.4.14). This slide is located at the landward flank of a trench-parallel sedimentary ridge. The slide has a width of ~3km and a length of ~6km. The upper part of the slide is characterized a steep erosional part while the lower depositional part shows numerous small blocks. Coring locations were selected based on the sub bottom profiler data close to the headwall in undisturbed sediments, at the glide plane and the edge of the slide. Unfortunately, coring, however, was not successful. A few sub bottom profiler data are shown in Figs. 5.4.15 to 5.4.17.

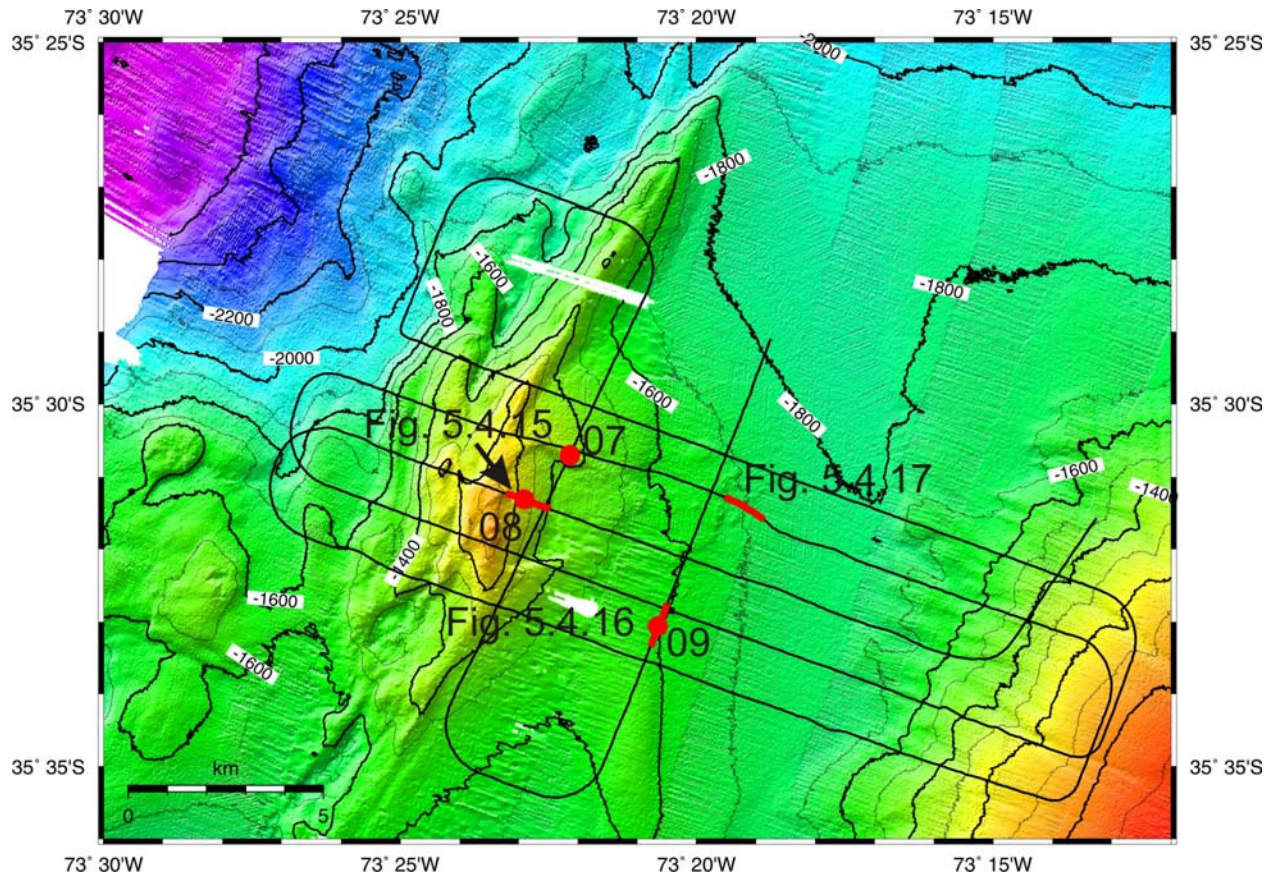

Fig. 5.4.14: Bathymetric map of a small slide in a mid slope location. The black lines are sidescan sonar profiles. Locations of cores are shown as circles. Locations of examples shown in Figs. 5.4.15 to 5.4.17 are marked as thick lines.

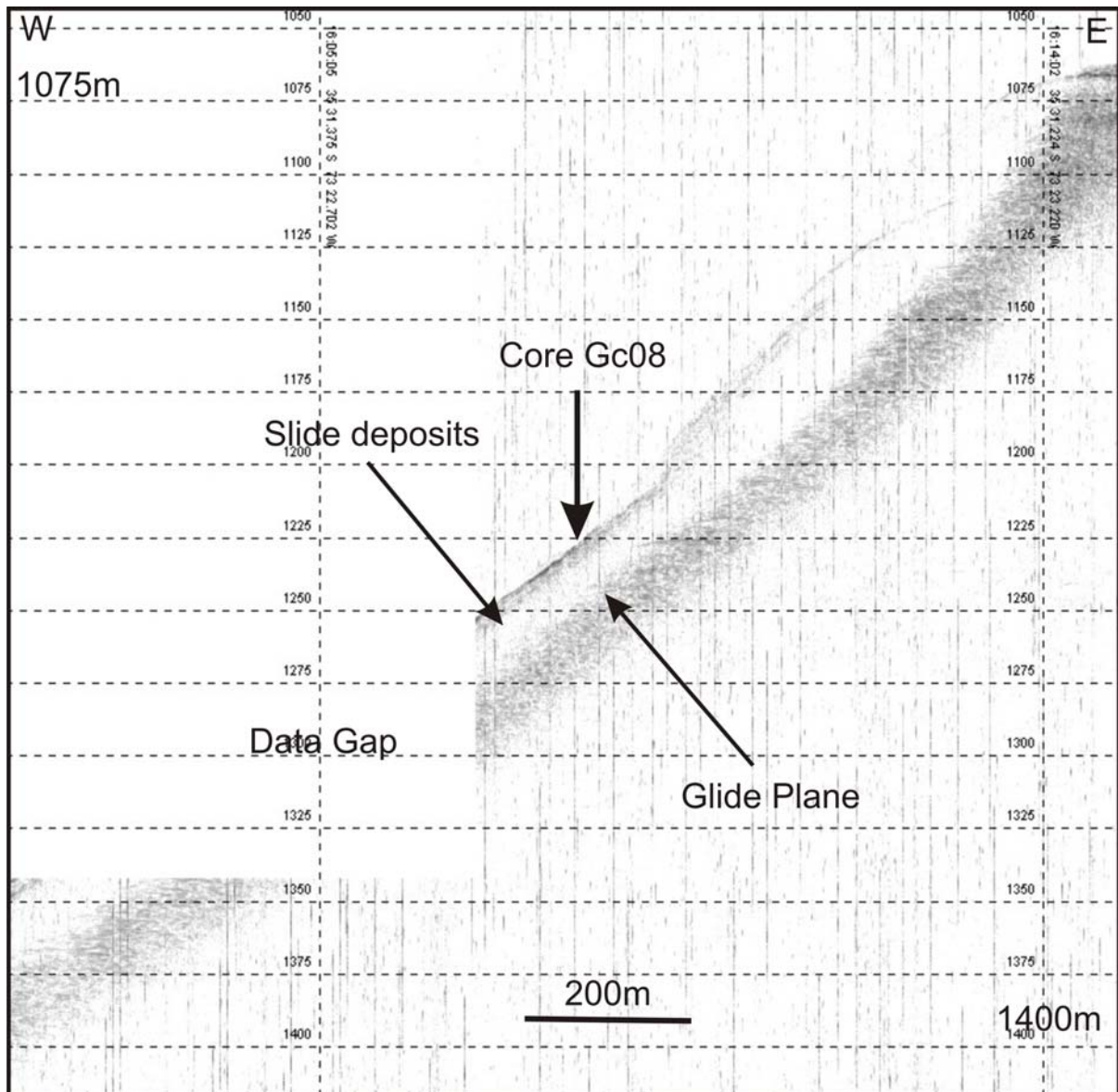

Fig. 5.4.15: Sub bottom profiler data crossing the head wall area. The slope angle is $\sim 12^\circ$. The glide plane is visible as a diffuse reflector covered by slide deposits. See Fig. 5.4.14 for location of profile.

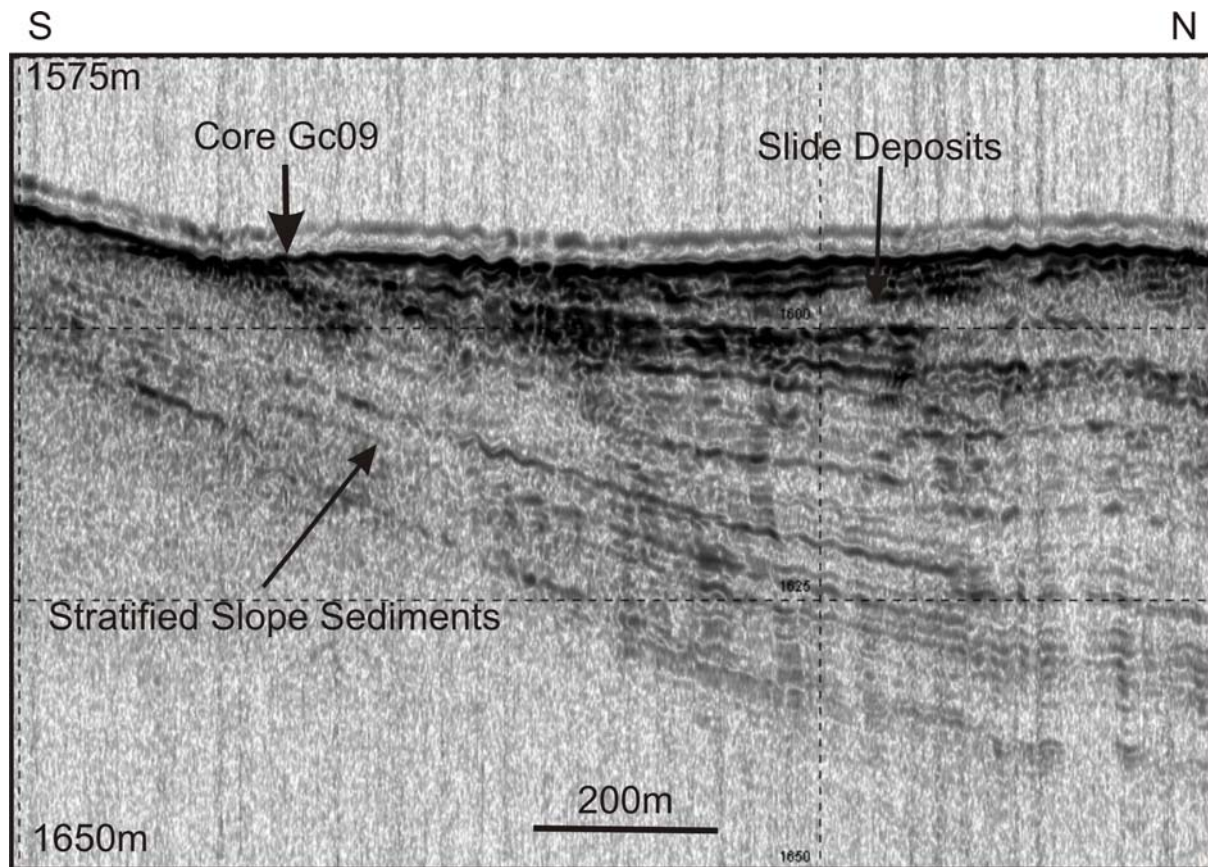

Fig. 5.4.16: *Sub bottom profiler data crossing the southern boundary of the slide. The slide overlies well stratified slope sediments. See Fig. 5.4.14 for location of profile.*

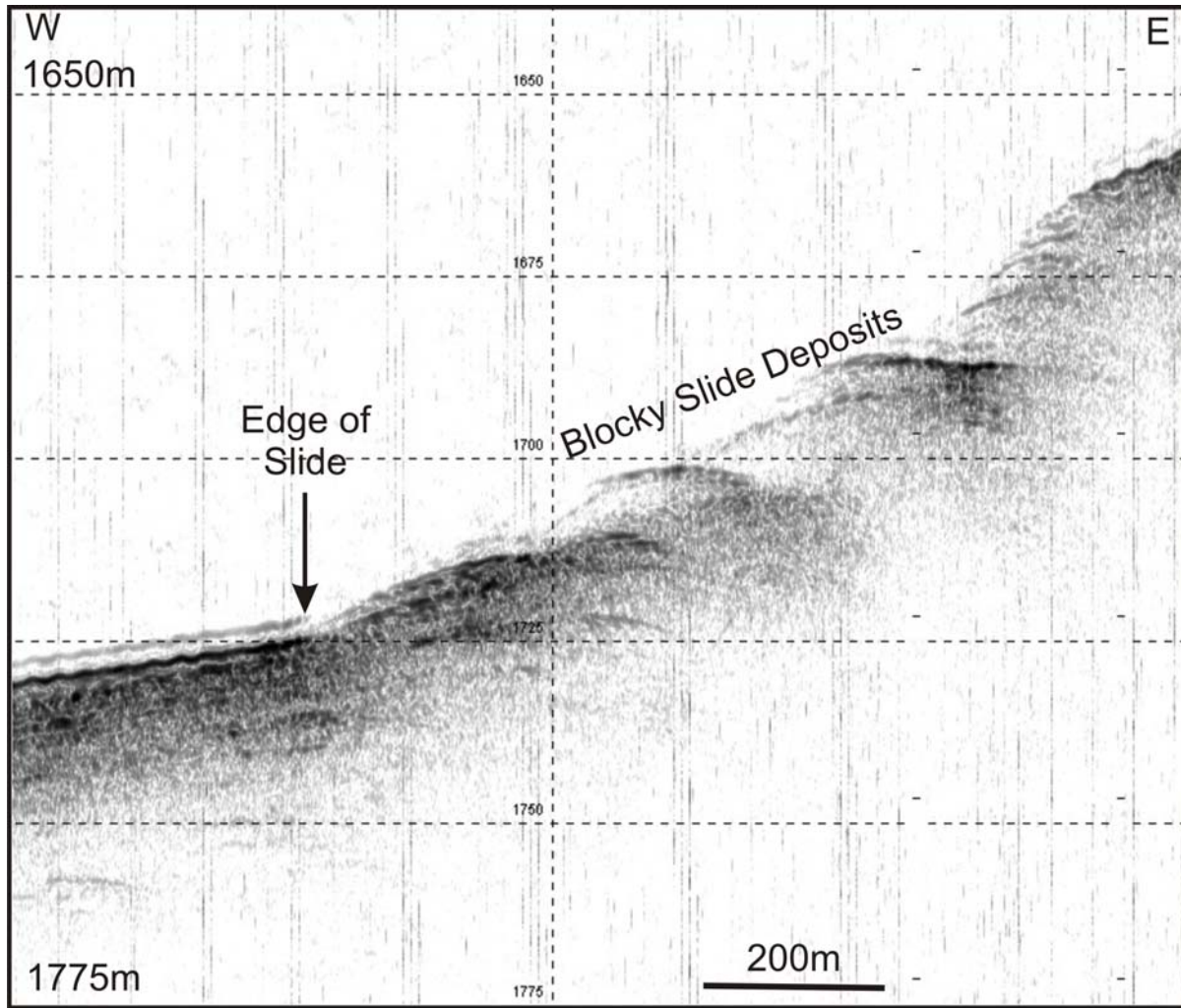

Fig. 5.4.17: *Sub bottom profiler data crossing the distal edge of the slide. The slide is characterized by a hummocky surface, while the normal slope sediments show a very smooth morphology. See Fig. 6.5.15 for location of profile.*

Three cores were taken on the oceanic Nazca Plate. Several horst and graben structures are identified on the Nazca Plate. All three cores were taken in small basins which are filled by undisturbed well stratified sediments. A typical example is shown in Fig. 5.4.18.

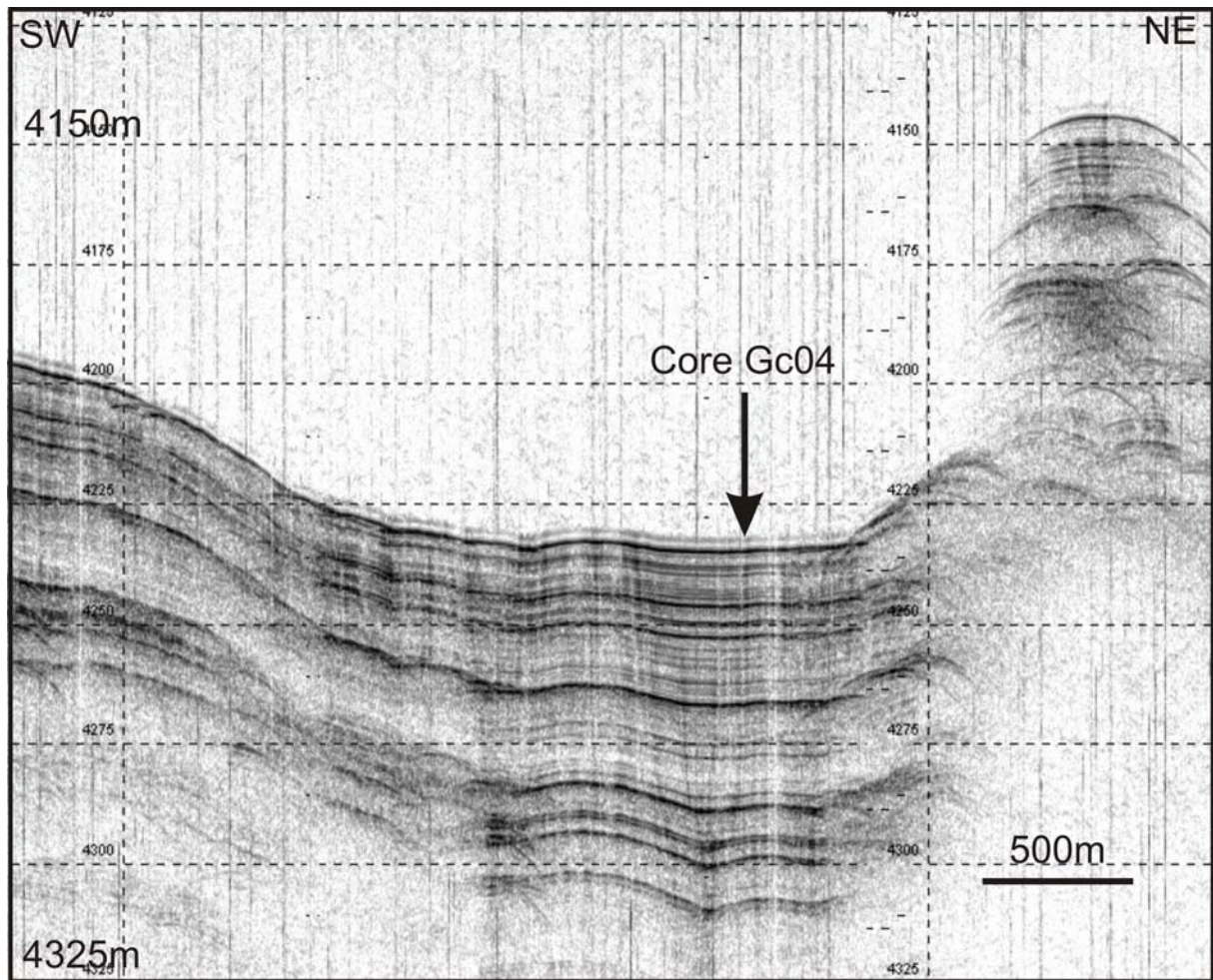

Fig. 5.4.18: Sub bottom profiler data crossing the location of gravity core GC04.
See Fig. 11.1 for location of cores.

6. Magnetics

A marine magnetics “SeaSpy” Magnetometer was operated during cruise JC 23 to record the Earth’s magnetic field (Fig. 6.1.) It was deployed during seismic profiling and during longer transit. The main aim was to observe seafloor spreading anomalies. These reversals were inherited during the creation of the seafloor and will therefore allow us to determine the age of the oceanic crust and to locate fracture zones. On the margin, magnetic anomalies may be used to further constrain the dip angle of the Nazca Plate and the nature of the margin wedge.

The SeaSpy Magnetometer, manufactured by Marine Magnetics Corporation, Canada (www.marinemagnetics.com), consists of an Overhauser total field sensor, attached to a 300 m long marine cable and a control unit. The Overhauser sensor operates on the proton spin resonance principle, but the proton-rich liquid within the sensor has been specifically engineered to allow the Overhauser effect to occur when the liquid is exposed to secondary polarization from a radio frequency magnetic field. In contrast to ordinary proton magnetometers the Overhauser magnetometer needs much less power and it can measure the magnetic field continuously.

In order to minimize the influence of the ship the sensor was towed 280 m behind the vessel. Thus the influence was less than 0.1 nT. On RRS James Cook a winch to which the cable is attached is placed on the starboard back deck. A boom leads the cable about 7 m to the side of the ship.



Figure 6.1: A photograph of the magnetometer.

Magnetic Data JC23
Reference Field: IGRF

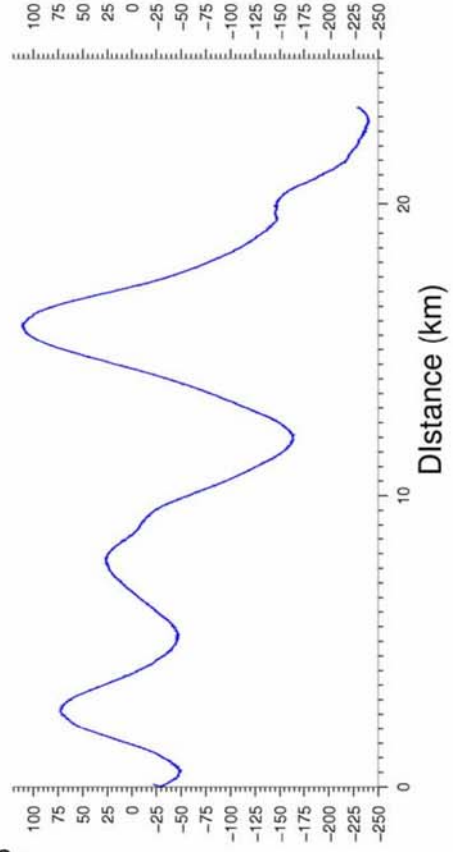
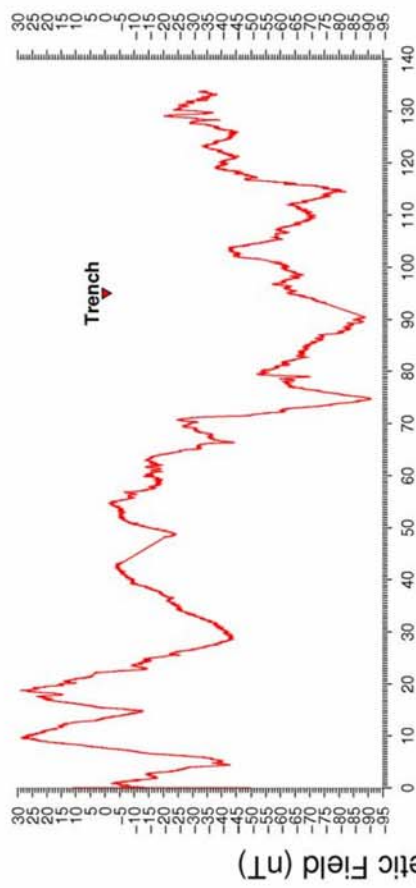
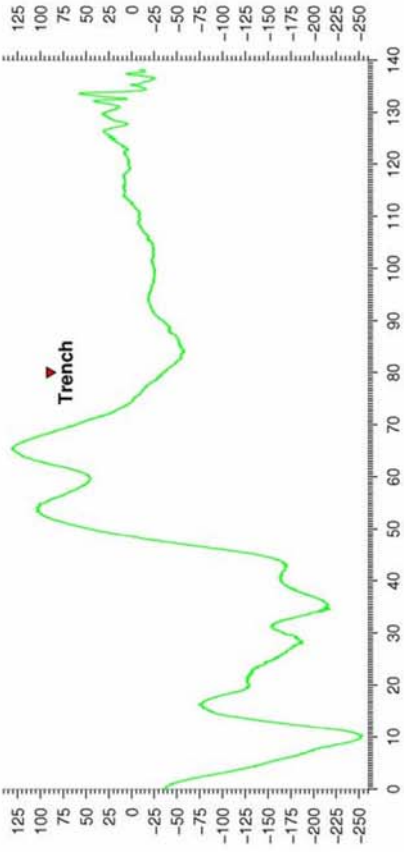
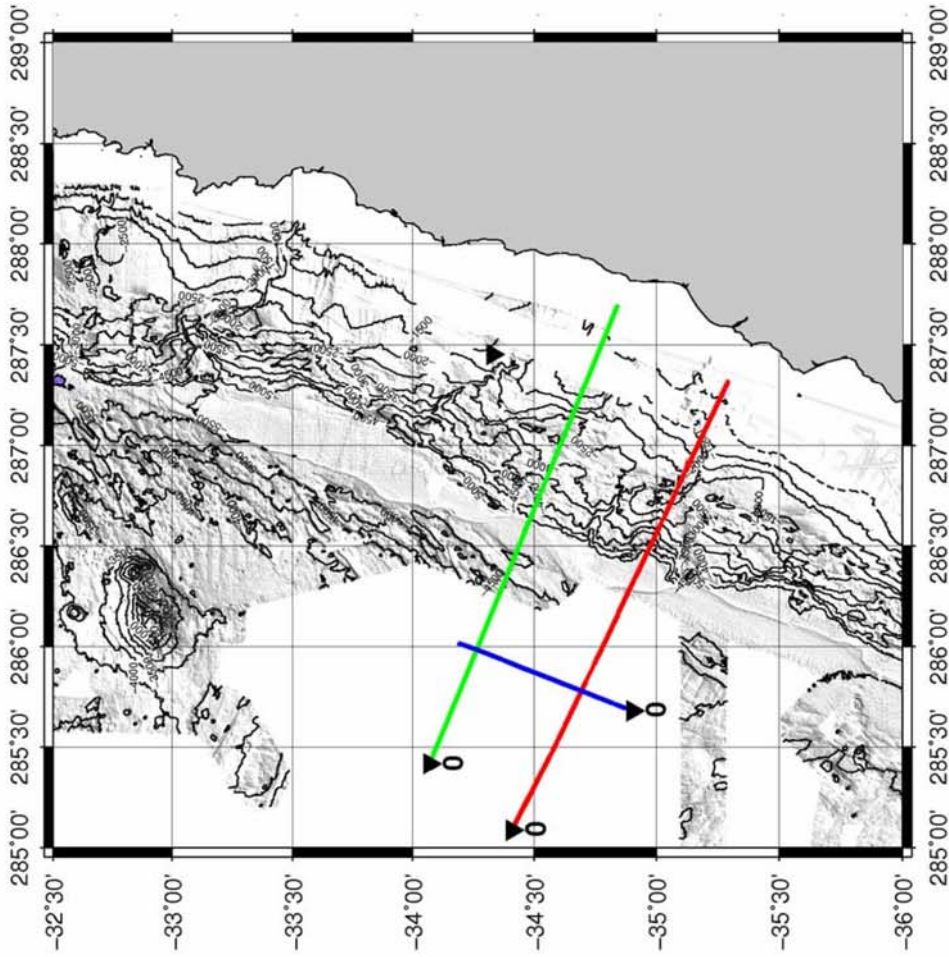

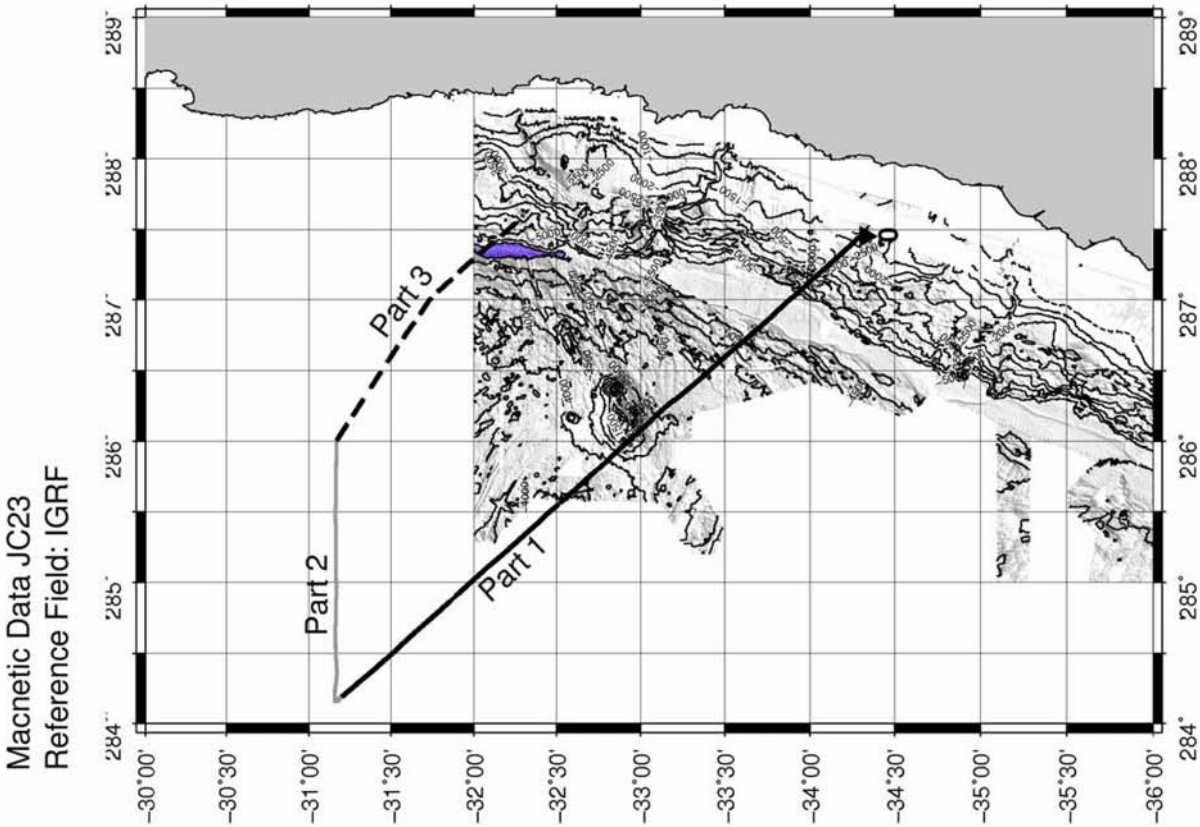
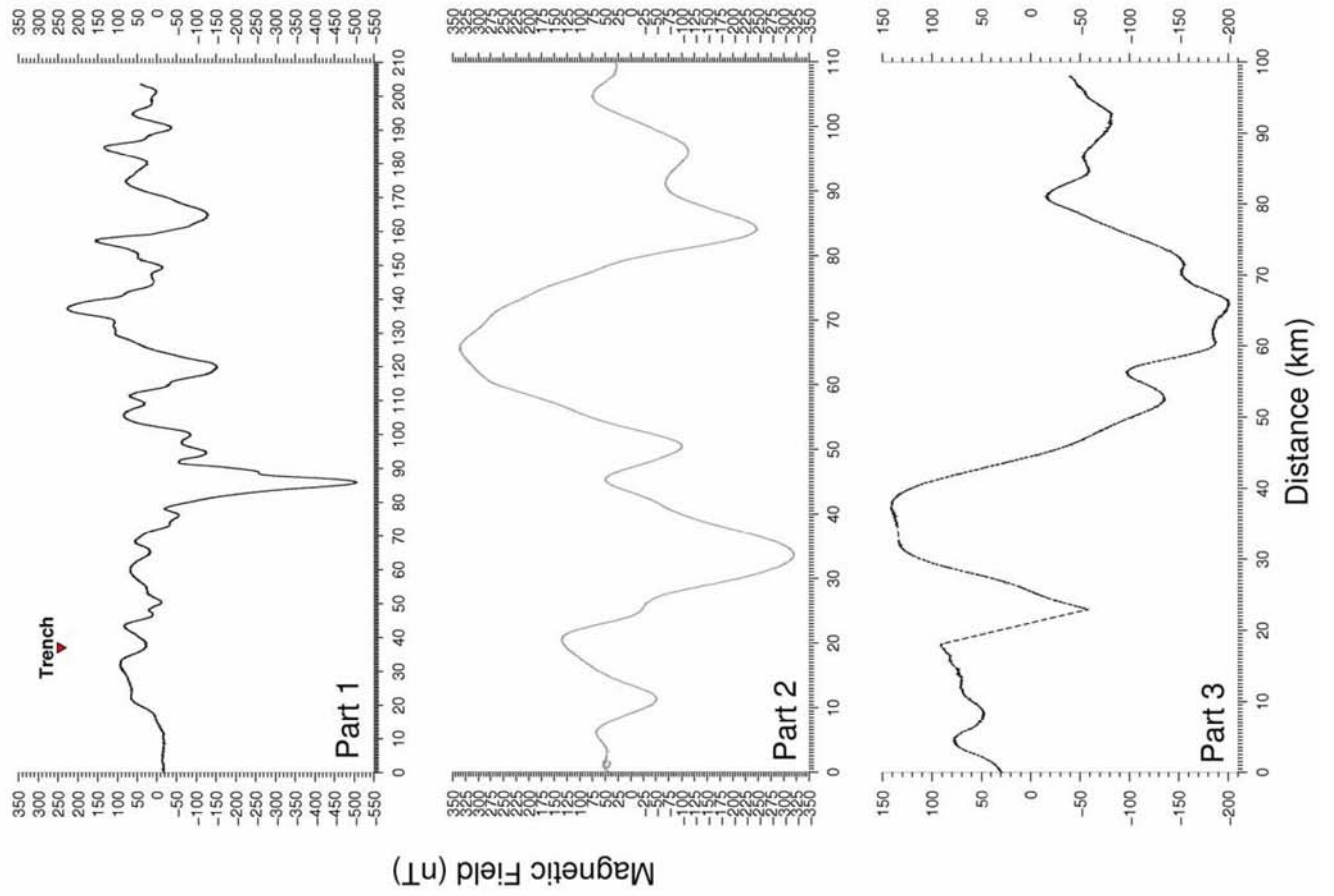

7. Gravity

The gravity data provide a first approximation of crustal thickness and can therefore confirm and back up the obtained seismic data. The Air-Sea Gravity System II is working permanently and is situated at the main deck (sea-level) in the gyro/gravimeter room (~43.2 m from stern, ~1.35 m portside from centre line), which is positioned close to the centre of motion. The dimensions of the gravity meter are about 71×56×84 cm and it has a weight (including the outer frame) of 86 kg.

The in-port checks include still reading, beam zero/gain check, k-check, a check of accelerometer levels and the dock-to-water height. Because of heavy fluctuations in water level and a change in position at port, the checks covered only still reading, a check of dock-to-water height and a gravity tie-in, which was carried out by means of measurements with a Worden gravity meter on land at a permanent gravity station with an absolute value (made 2002) and reference measurements at port to obtain the drift value.

The Micro-g LaCoste Air-Sea gravity meter (Model S) consists of a highly damped, spring type gravity sensor mounted on a gyro-stabilized platform. The sensor includes a hinged beam supported by a zero-length spring, whereby damping of the vertical accelerations due to the ship's motion is attained by air dampers. As a result of the very high damping of the beam and the high sensitivity of the gravity sensor, the acceleration term and the position term can be neglected. Hence it is not required to keep the beam constantly nulled. The stabilized platform is held on a horizontal plane by a servo system, which includes a pair of gyros, that supply signals that get amplified and send to the torque motors, which make the platform follow the gyro output. Hence this first loop stabilizes the platform in space. In addition the gyro is supported by a vertical reference signal provided by an accelerometer to reference the first loop, that the gyro can be precessed through the signal by the second loop and maintain the reference line vertical. To sum up the function in the Micro-g LaCoste stabilized platform is to derive the sum of the accelerometer output plus a constant multiplied by its integral, by whose combination the platform behaves like a damped pendulum.

The sensor works with a range of 12,000 mGal (worldwide) and has a drift of 3 mGal per month or less. The stabilized platform has a range of 25' roll and 22' pitch, the platform period is about 4 minutes to 4.5 minutes and user adjustable, whereby the platform damping is set at 0.707 times critical (U.S. Patent No. 3,474,672).

The Air-sea gravity meter is made for dynamic applications and operates with negligible errors in gravity due to vibration in the 0-100 Hz range at any amplitude which may be reasonably expected. The data recorded by the SEALOG software are unfiltered 1-second data, so that they can be re-computed and filtered according to the requirements of the exploration. The data have an accuracy of 1.0 mGal or better and are recorded in CU (Counter Units).

In Appendix 15.3 the harbour readings and calibrations are given.

8. Multibeam Bathymetry

8.1 Kongsberg multibeam bathymetry systems on RRS JAMES COOK

To allow for efficient and economic bathymetric mapping in shallow and in deep water, two multibeam systems, a shallow-water Kongsberg EM-710 as well as a deep-water Kongsberg EM-120 system are installed on RRS James Cook. Figure 8.1.1 gives an overview on the installed hydroacoustic systems.

The EM-710 is a new 2 by 2 degree broadband multibeam echosounder operating in the 70 kHz to 100 kHz band. It uses CW (continuous wave) pulses in shallow modes and FM (chirp) pulses in deep modes. Maximum water depth of the system is up to 1500 m to 2000 m, however the most efficient depth range for the EM-710 is less than 500 m. In this depth it has a better resolution and a slightly wider swath than the EM-120. For greater depths, the EM-120 system is the system of choice. As the main area of investigation during the cruise JC-23 was in water with depths greater than 500 m the EM-710 was operated only occasionally during the cruise, data from the EM-710 had not been processed and used in this report.

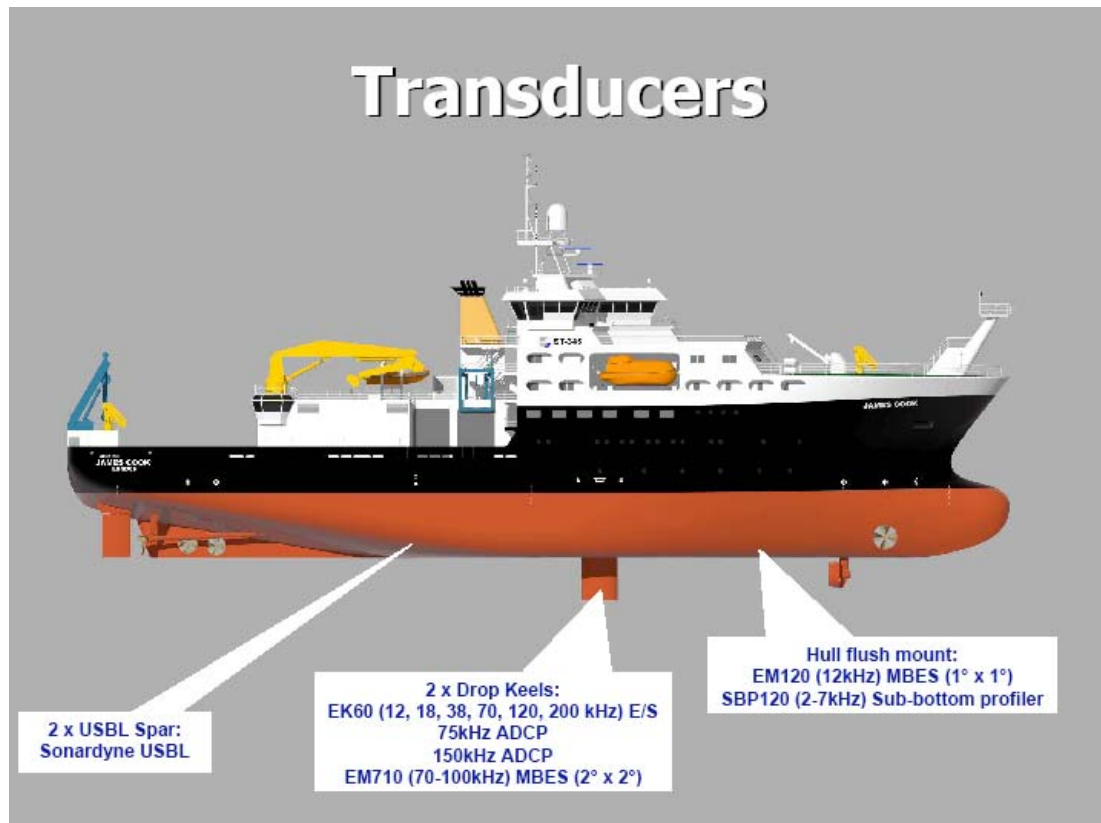

Figure 8.1.1: RRS James Cook – positions of hydroacoustic transducers

EM-120 System description

The EM120 system is a deep-water multibeam echosounder providing accurate bathymetric mapping up to full ocean depth. Basic components of the system are two linear transducer arrays in a Mills cross configuration with separate units for transmit and receive. The nominal sonar frequency is 12 kHz with an angular coverage sector of up to 150° and 191 beams per ping. The emission beam is 150° wide across track, and 1° along track direction. Reception is obtained from 191 beams, with widths of 1° across track and 20° along track (Fig. 8.1.2). Thus the actual footprint of a single beam has a dimension of 1° by 1° . Achievable swath width on a flat bottom will normally be up to six times the water depth dependent on the character of the seafloor (Fig. 8.1.3). The angular coverage sector and beam pointing angles may be set to vary automatically with depth according to achievable coverage. This maximizes the number of usable beams. The beam spacing is normally equidistant with equiangle available. For depth measurements, 191 isolated depth values are obtained perpendicular to the track for each ping. Using the 2-way-travel-time and the beam angle known for each beam, and taking into account the ray bending due to refraction in the water column by sound speed variations, depth is calculated for each beam. A combination of amplitude (for the central beams) and phase (slant beams) is used to provide a measurement accuracy practically independent of the beam pointing angle.

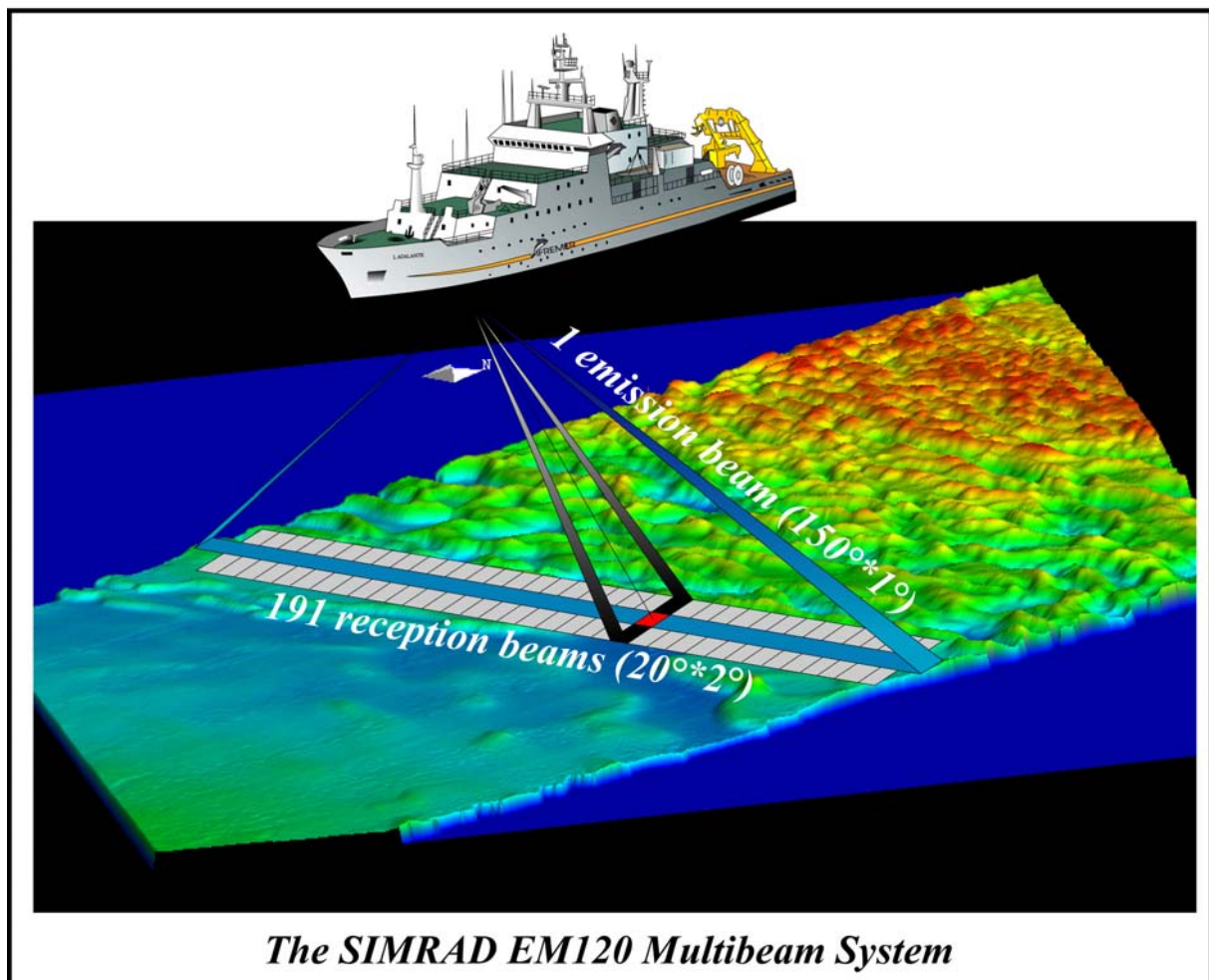

Figure 8.1.2 : Basic principle of multibeam echosounding with Kongsberg EM-120

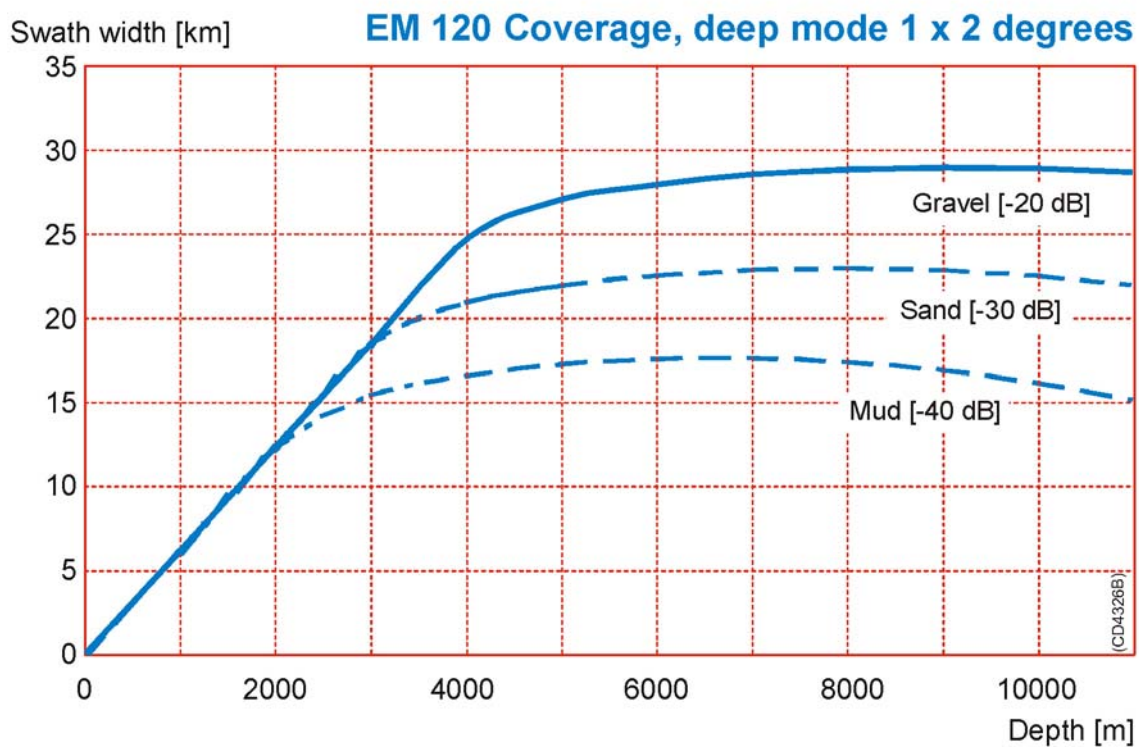

Figure 8.1.3: Coverage diagram for the Kongsberg EM120

EM-120 multibeam data processing

Generally processing of multibeam data requires two sequences of processing steps: a profile-oriented sequence followed by area-based processing. The profile-oriented processing of the EM120 data comprises the check of navigation data, interpolating missing navigation values, the calculation of water depth and positions of the footprints of the beams by raytracing through the water-column taking into account the sound velocity profile, and removing artefacts and erroneous data points. Area-based processing comprises the calculation of a digital terrain model (DTM) and the visualisation of the data in various different presentations. For these purposes the NEPTUNE software package from Kongsberg is available onboard RRS JAMES COOK. However, mainly for easier integration of other data from different systems in various data formats, the “open source software” packages MB-System (Caress and Chayes, 1996) and GMT (Wessel and Smith, 1995) were used for the processing of the multibeam data during JC23 cruise.

Data of the multibeam system Kongsberg EM-120 is stored continuously during operation on the disks of the operator workstation in a vendor specific raw-data format. Data is organized in SURVEYS. A survey is initiated by the operator on the operator console. Generally a new survey was initiated when working in a new area started. The raw data was copied to the disks of the IFM-GEOMAR workstations by ftp.

In the MB-System software the Kongsberg vendor specific raw data format is defined as format 56. Further processing of the data requires the conversion of the data to the MB-System format 57. In addition, some ancillary files have to be created, containing meta information for each file. These files speed up further processing steps. In MB-System the

management of the data is maintained by so-called datalist-files, which contain names, paths, format-ID and a weighting factor for each file. Datalist files can be set up recursively, i.e. entries in a datalist refer to another datalist, which points to the actual data files. This structure helps to easily keep track of all data files which can grow to several thousand files for a normal-sized project. For the JC23 cruise, the number of raw data files sum up to more than 2100. The format conversion, the creation of ancillary files and the set up or updating the respective datalist files is accomplished by the script

```
prepare_work.sh <cruise> <survey_name>.
```

Two steps follow in the processing sequence which have to be carried out interactively. The cleaning of the raw data by flagging outliers and artefacts are done with the programme

```
mbedit -F57 -I<filename>
```

for each of the raw data files. This quite time-consuming step requires careful inspection of all pings and beams in each raw data file. Following this the navigation has to be checked interactively with the programme

```
mbnavedit -F57 -I<filename>
```

for each raw data file. The interactive editor programmes do not change the data files, they only store the edit instructions to a file. Following the interactive editing, the data files are actually updated by a call to the programme

```
mbprocess -F-1 -I<datalist file>
```

Any intended further data processing step, e.g. application of a different water sound velocity profile or additional roll- or pitch- bias correction, is accomplished by parameter files. The programme mbprocess checks the existence of an adjunct parameter file for each data file and takes the instructions contained therein into account during processing. After successful completion of mbprocess the profile-oriented data processing is finished.

An area in the context of “area based multibeam data processing” is a rectangular survey area defined by its geographical coordinates (minimum and maximum latitude, minimum and maximum longitude). All processed multibeam data that fall within this box will be integrated in the calculation of a digital terrain model (DTM) for this survey area. For each survey area a directory with its name is created. Key parameter for a survey area (name, boundaries, scale) are stored in the file .hsdefaults in that directory. The access to the processed data files is accomplished by a datalist file, as already introduced above. For the calculation of the DTM of the area the script

```
process.cmd
```

is executed. The DTM is represented by a regular grid. Basic parameters for the DTM calculation are the name of the datalist-file, the grid size in lat and long as well as the number of grid cells without data, which will be filled by interpolation.

The basic script for the presentation of the DTM is

```
fig_bathy.cmd
```

which follows the successful calculation of the DTM. Different presentation modes (isocontours, colour coded, colour coded with illumination and combinations) are available (c.f. comments in the script for a complete description).

multibeam system performance on RRS James Cook

Being the newest vessel of the research fleet of NERC, James Cook provides state-of-the-art hydro-acoustic systems however, the design of the ship and particularly of the hull deteriorates survey data. The survey results do not at all match quality requirements as could be anticipated from that kind of equipment. This has already been realized by the operating body NMF-SS at NERC (West,2007) who conceded a significant “bubble sweep-down” problem. This is probably due to the bulbous bow of the vessel and the openings of the bow thrusters in the hull. Generally the EM-120 multibeam system which can survey a swath of up to 150° width was operated during the cruise JC-23 with a swath angle of just 90°. Furthermore, when the vessel was heading against waves and swell no data was recorded at all.

8.2 Work done and preliminary results

8.2.1 Water sound velocity profile

On March 4 a sound velocity profile was measured with a CTD at position 72.9166670° W and 34.0816670 S. The graph of the sound velocity as well as the temperature in the water column is shown in Fig. 8.2.1.1. This water sound velocity profile was used throughout the survey for the processing of the multibeam data.

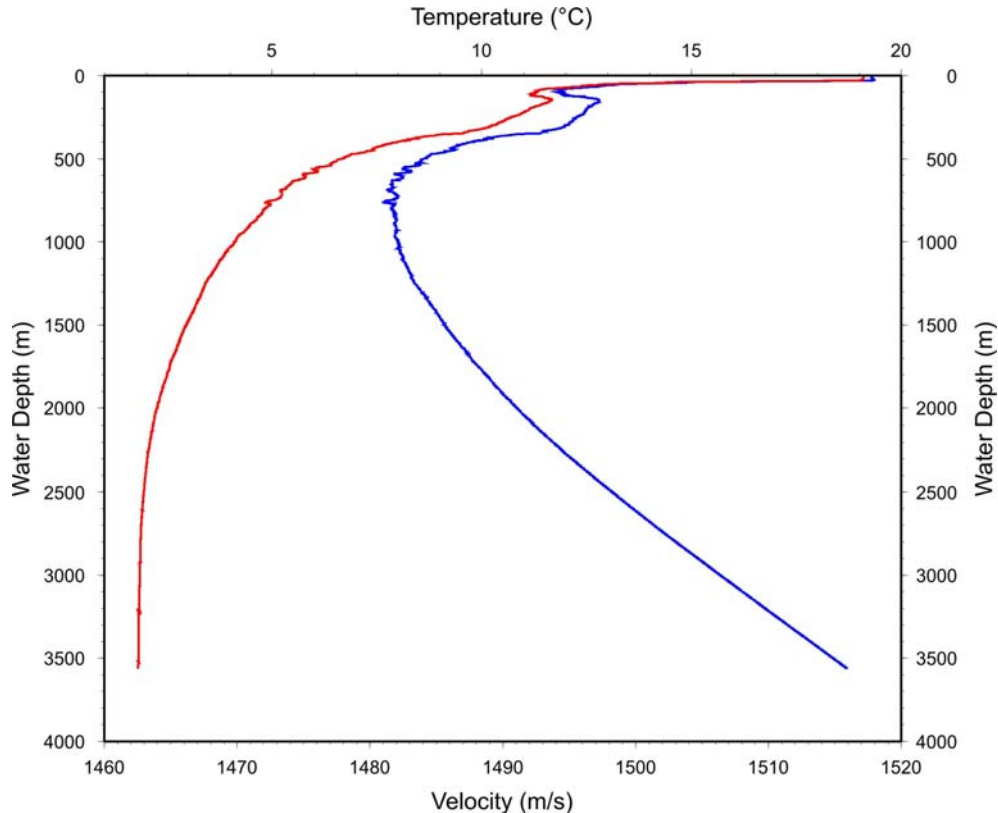

Figure 8.2.1.1: *Sound velocity and temperature profile measured with a CTD at position 72.9166670°W / 34.0816670°S.*

8.2.2 Multibeam bathymetry survey results

As large parts of the area of investigation had already been surveyed bathymetrically multibeam mapping was not a primary objective of the cruise JC23. Yet the multibeam systems were operated continuously throughout both legs of the cruise. As has been outlined in 8.1.3 the performance of the hydro-acoustic systems were quite disappointing. Large amount of the recorded data were not usable. However some significant extensions to the existing maps were achieved. Figure 8.2.2.1 shows the preliminary data recorded during JC23-A. The data is not finally processed as can be seen in several distorted sections. Figure 8.2.2.2 displays the area mapped during JC23-B. A compiled map integrating the JC23 recordings with all available bathymetric data from earlier cruises is shown in figure 8.2.2.3. As can be seen in this figure, the continental margin in the area between 33°S and 37°S has nearly totally been mapped from the incoming oceanic plate to the upper middle slope. To show more detail the figures 8.2.2.4 to 8.2.2.10 display blow-ups of the area in a sequence from South to North as indicated by the red boxes in figure 8.2.2.3.

The morphology of the surveyed area shows an irregular slope toe facing the trench, surprisingly, the turbidite-flooded trench is not faced by a well-developed system of accretionary ridges. Generally, the morphology of the continental slope displays three different regions: The lower slope typically displays a rugged terrain, including collapse structures, whereas the middle slope is characterized by a series of smooth terraces probably representing mid-slope basins. The transition from the lower to the middle slope occurs across a roughly margin-parallel 150-km-long distinct lineament of alternating narrow highs and troughs. These structures indicate local uplift and subsidence along the same lineament, suggesting strike-slip deformation along a fairly continuous array of faults. Their sharp relief and the transition from a rugged to a smooth morphology across them suggest that faulting is currently active. Across a moderate change in slope dip, the middle slope grades into the upper slope, which displays a smooth morphology and gentle dips. The entire slope structure is cut by several large canyons that zigzag from near the coast to the trench. The canyons head is typically located at the mouth of the largest rivers in the area and possibly transport most of the sediment reaching the trench.

A remarkable feature in the southern part of the lower continental slope is a large slump and an olistolith at 35°35'S shown in figure 8.2.11. The scarp of this giant slump spans a height difference of nearly 1500 m. The detached block has a size of about 7 km by 3 km. The debris fan can be traced over a horizontal distance of more than 14 km. The trench-parallel turbidite channel, which can be traced throughout the Chile subduction zone from 41°S up to 33°S, has partly been covered by the debris fan documenting that the age of the slump must be quite young. Figure 8.2.2.12 displays the slope (absolute value of maximum gradient of the digital terrain model) of the area. The outline of the debris fan is clearly enhanced in this kind of presentation. Figures 8.2.2.13 to 8.2.2.15 show perspective views of the digital terrain model illustrating the remarkable dimensions of this structure.

Multibeam bathymetry systems had also been operated during the deep-tow side-scan sonar surveys. Due to the slow towing speed the multibeam data quality was comparatively good. In addition, the small distance between profiles allowed setting the total swath width to 90° and less resulting in a high spatial data density. Hence digital terrain models could be calculated on a regular grid with a spacing of just 20 m and less. Figure 8.2.2.16 shows the terrain model of the DTS-1 survey. This survey was run in order to search for manifestations of fluid venting. At this mid-slope area Chilean colleagues had reported the occurrence of gas

hydrates in a gravity core. Figure 8.2.2.17 shows a perspective image of the same area. Unfortunately no indications for fluid venting have been found in the DTS-data.

The second DTS-1 survey was run over a mid-slope submarine landslide. This landslide close to the Cape Valdes ashore was named “Valdes-landslide”. The slide originated at the highest point of an elongated ridge. The edges of the failure plane are quite distinct which indicates that the slide could be quite fresh. The bathymetry of the slide is shown in figure 8.2.2.18, the corresponding slope image is shown in figure 8.2.2.19, a perspective view of the slide in figure 8.2.2.20.

The third DTS-1 survey covered an area just south of the area of the first DTS-1 deployment. The bathymetry is shown in figure 8.2.2.21. Gravity cores taken during the M67/1-cruise with RV METEOR in this part of the middle slope showed indications of methane. Small mound-like features can be found in the high resolution bathymetric map at an elongated North-South trending small ridge at $73^{\circ}43'W$ between $36^{\circ}22'S$ and $36^{\circ}32'S$. These features are characterized by a strong acoustic backscattering strength as can be seen in figure 8.2.2.22 which shows the “pseudo”-sidescan signal of the EM-120 multibeam system mapped during the cruise M67/1. High-backscatter patches at the positions of the mounds are indications of carbonate patches and hence indications for fluid venting. Perspective views of morphology of the area are shown in figures 8.2.2.23 and 8.2.2.24 displaying the mounds on top of the small ridge. In figure 8.2.2.25 the side-scan information of the EM-120 is draped over the bathymetry, illustrating the coincidence of the high-backscatter patches and the mounds.

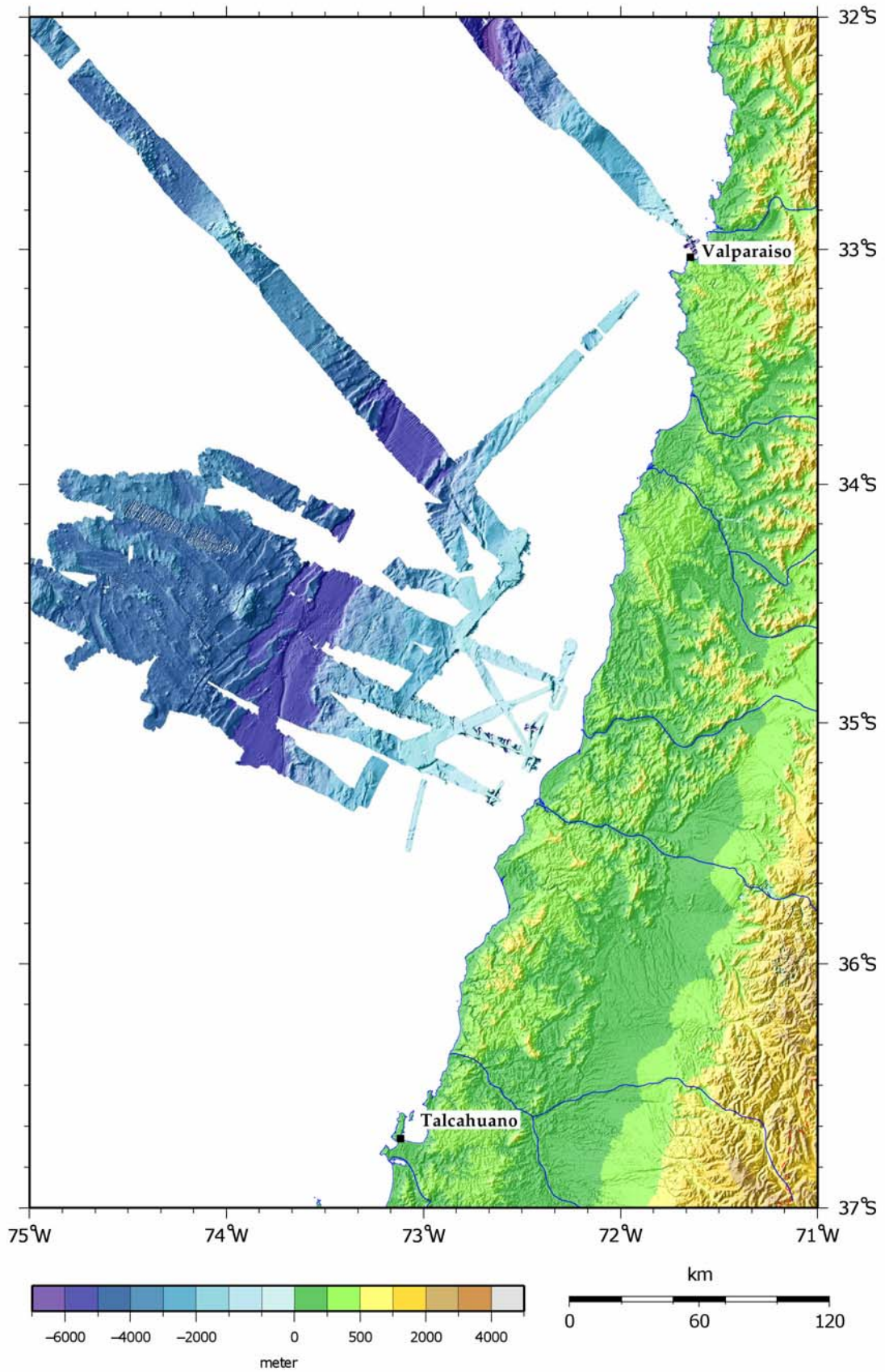

Figure 8.2.2.1 Colour-coded, shaded relief map of the topography of the survey area and the bathymetry mapped during cruise JC23 leg A.

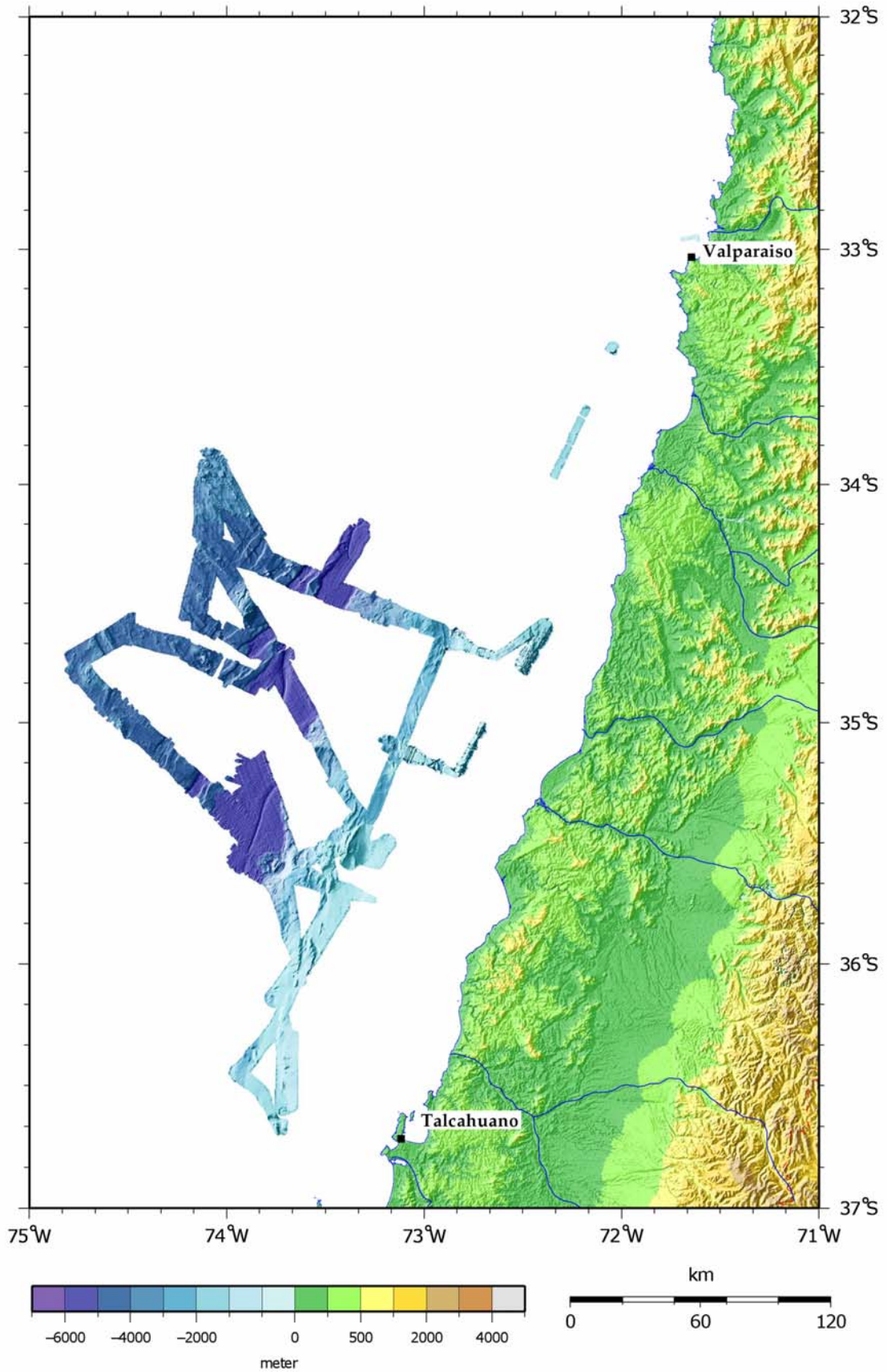

Figure 8.2.2.2 Colour-coded, shaded relief map of the topography of the survey area and the bathymetry mapped during cruise JC23 leg B.

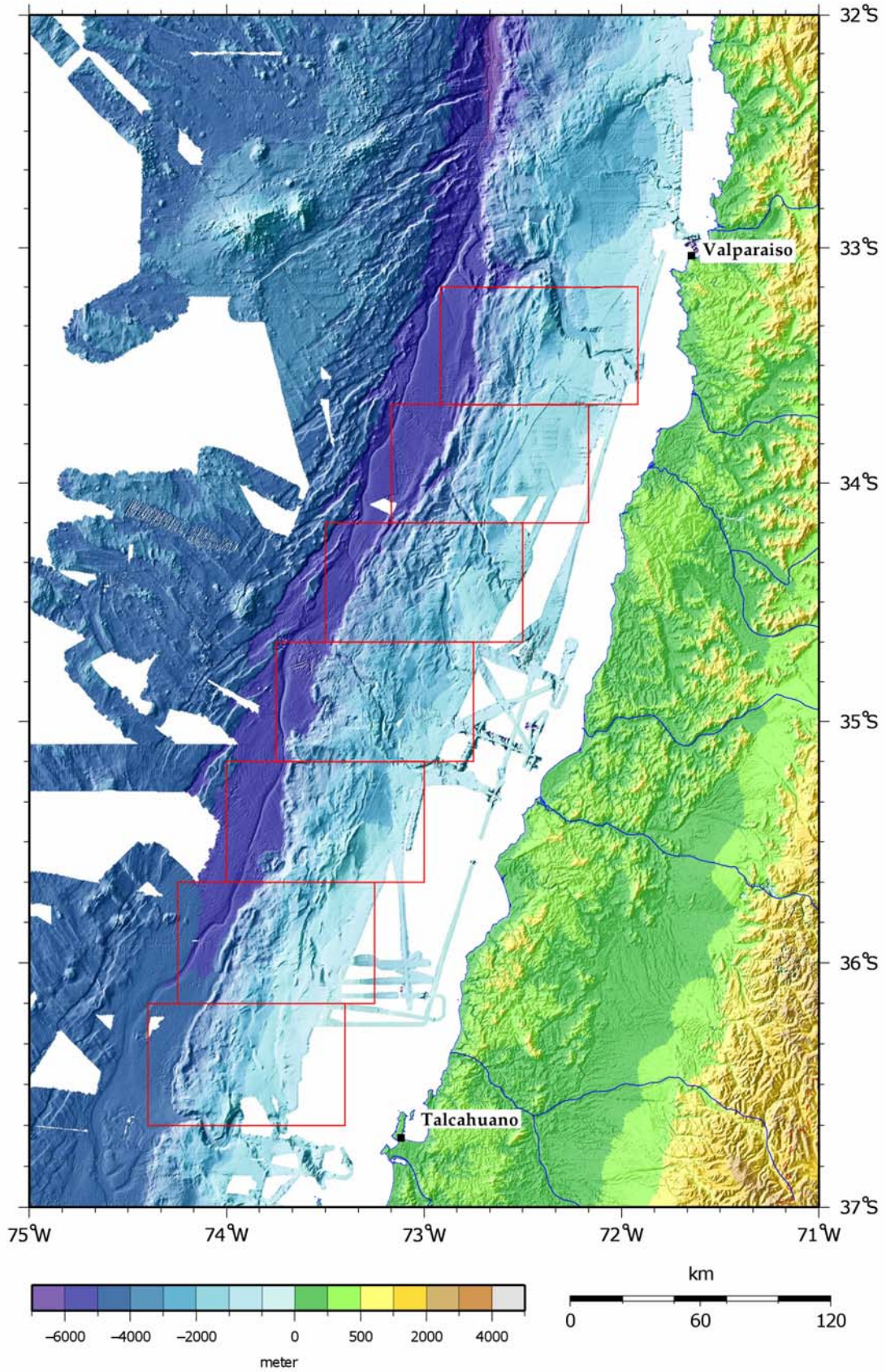

Figure 8.2.2.3: Colour-coded, shaded relief map of the topography of the survey area and compilation of all available bathymetry including the data from JC23.

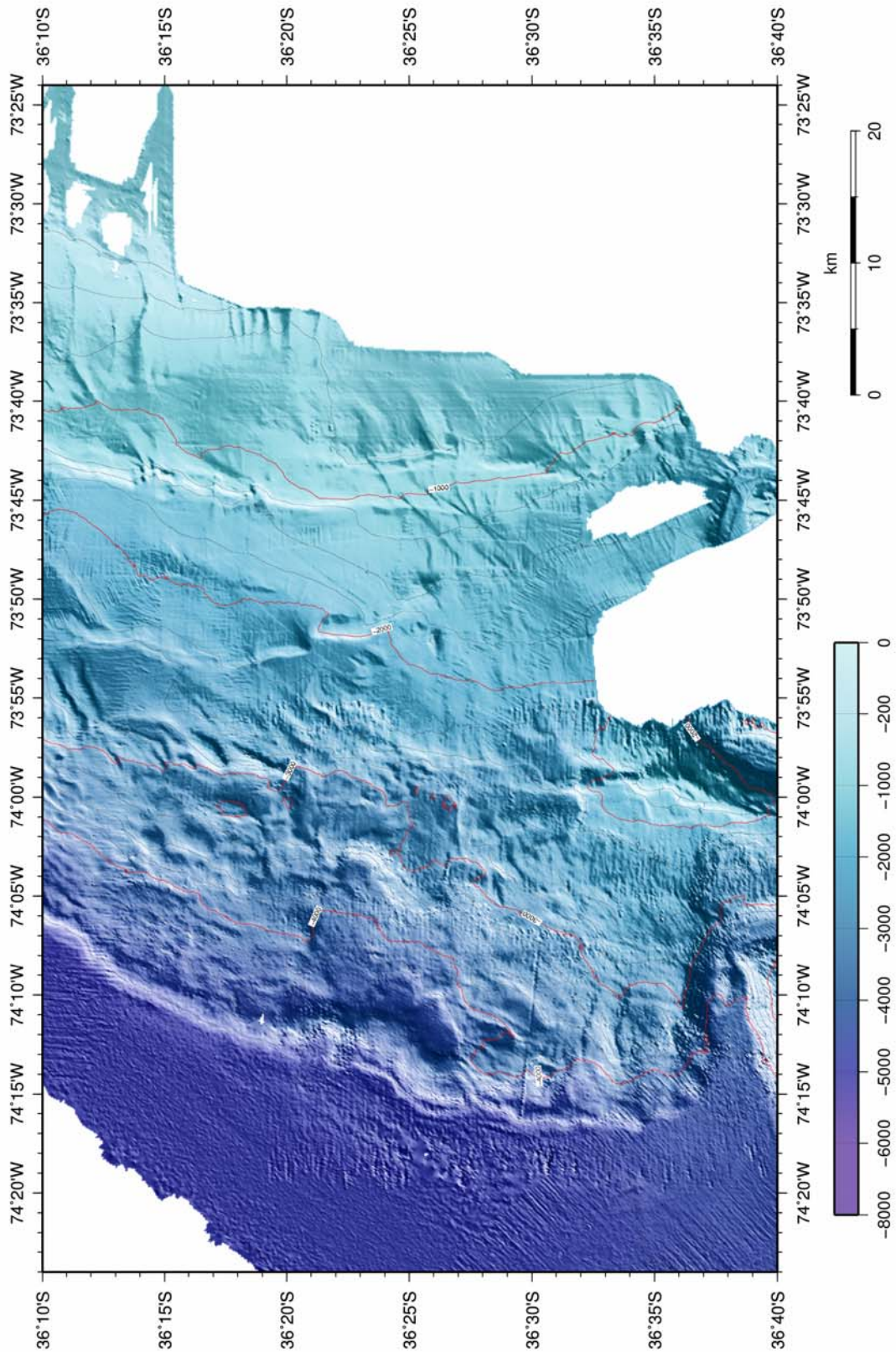

Figure 8.2.2.4 Colour-coded, shaded relief map of the bathymetry of the continental margin between 36°40'S and 36°10'S

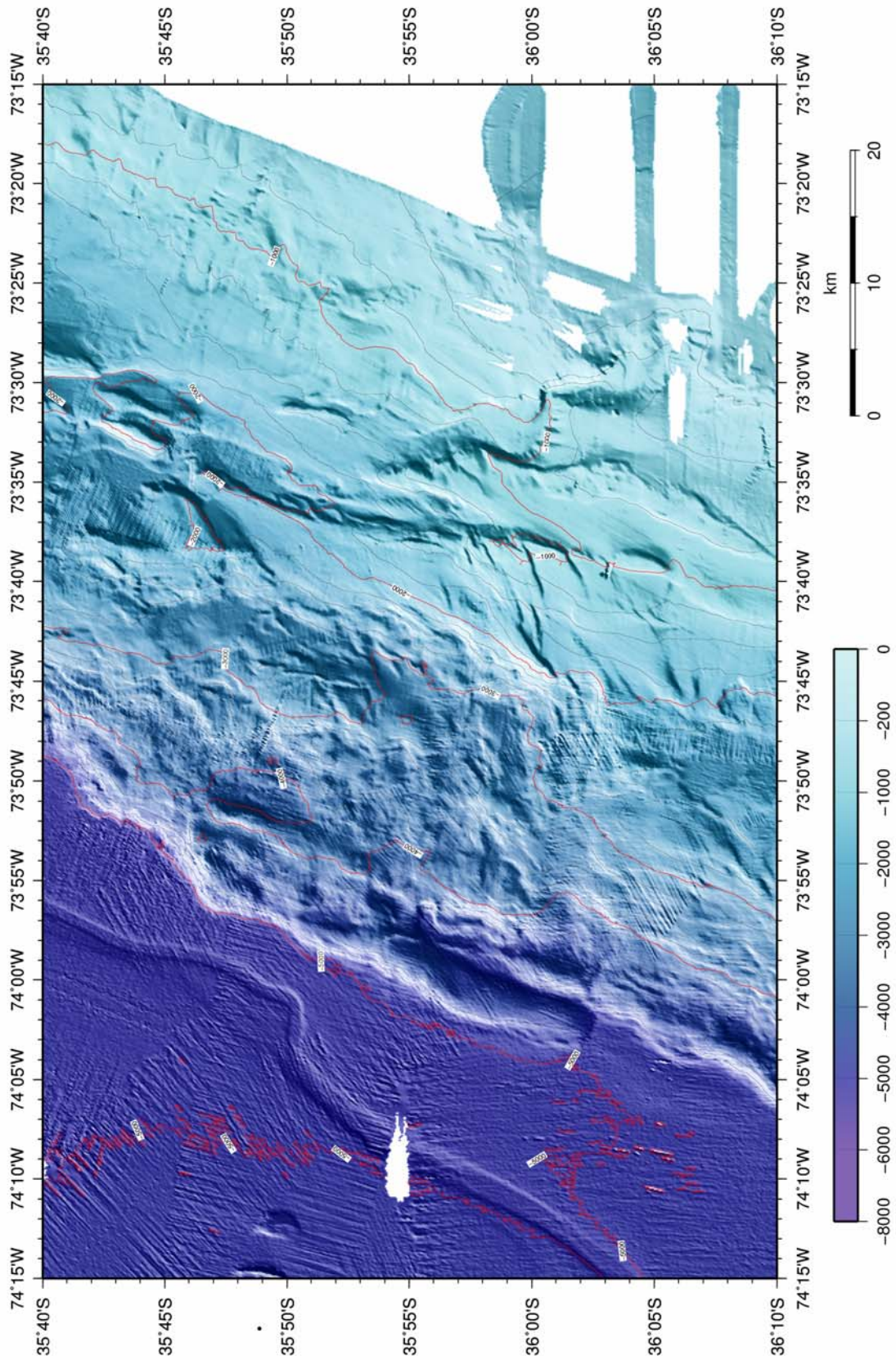

Figure 8.2.2.5 Colour-coded, shaded relief map of the bathymetry of the continental margin between 36°10'S and 35°10'S

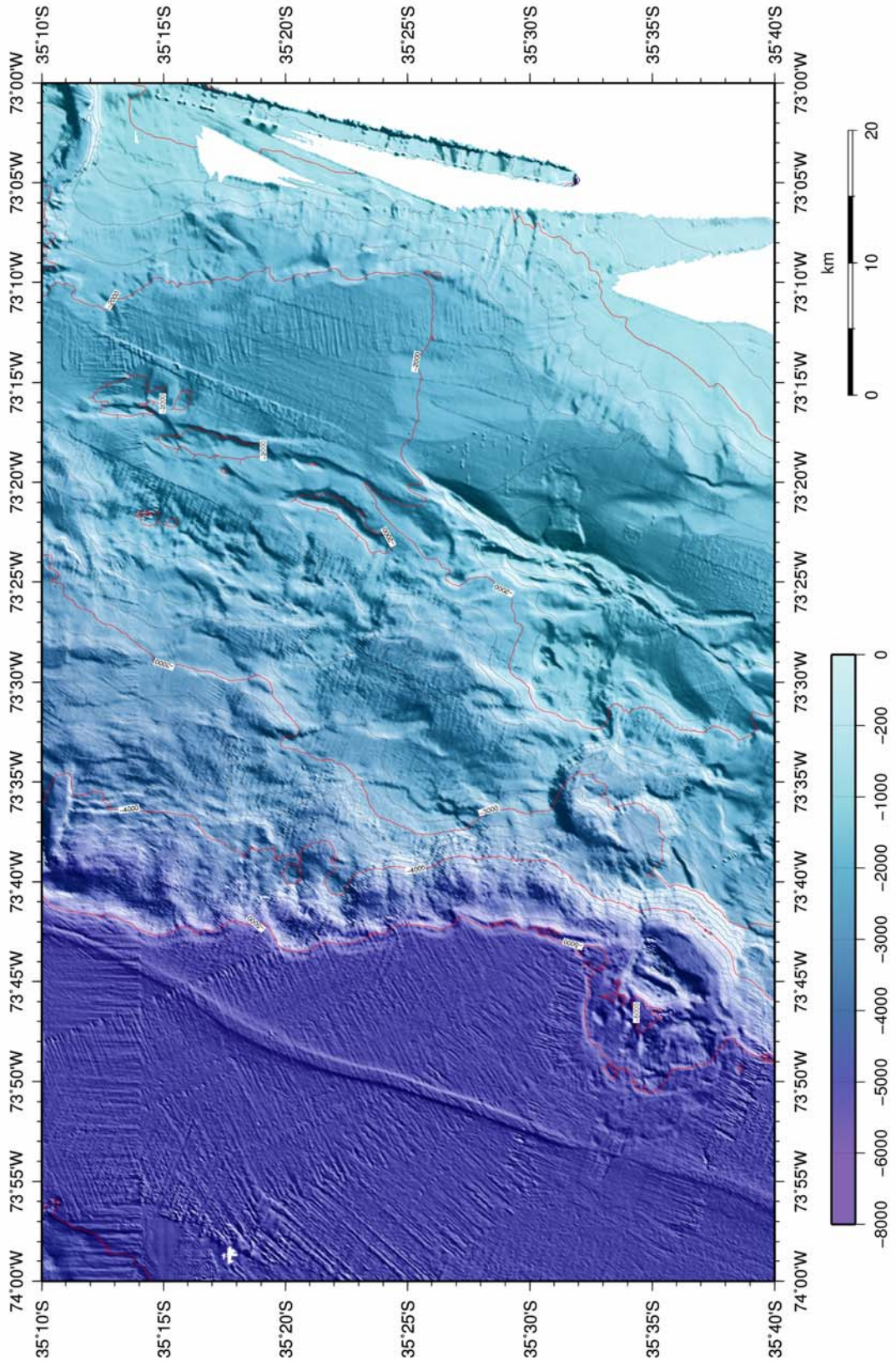

Figure 8.2.2.6 Colour-coded, shaded relief map of the bathymetry of the continental margin between 35°40'S and 35°10'S

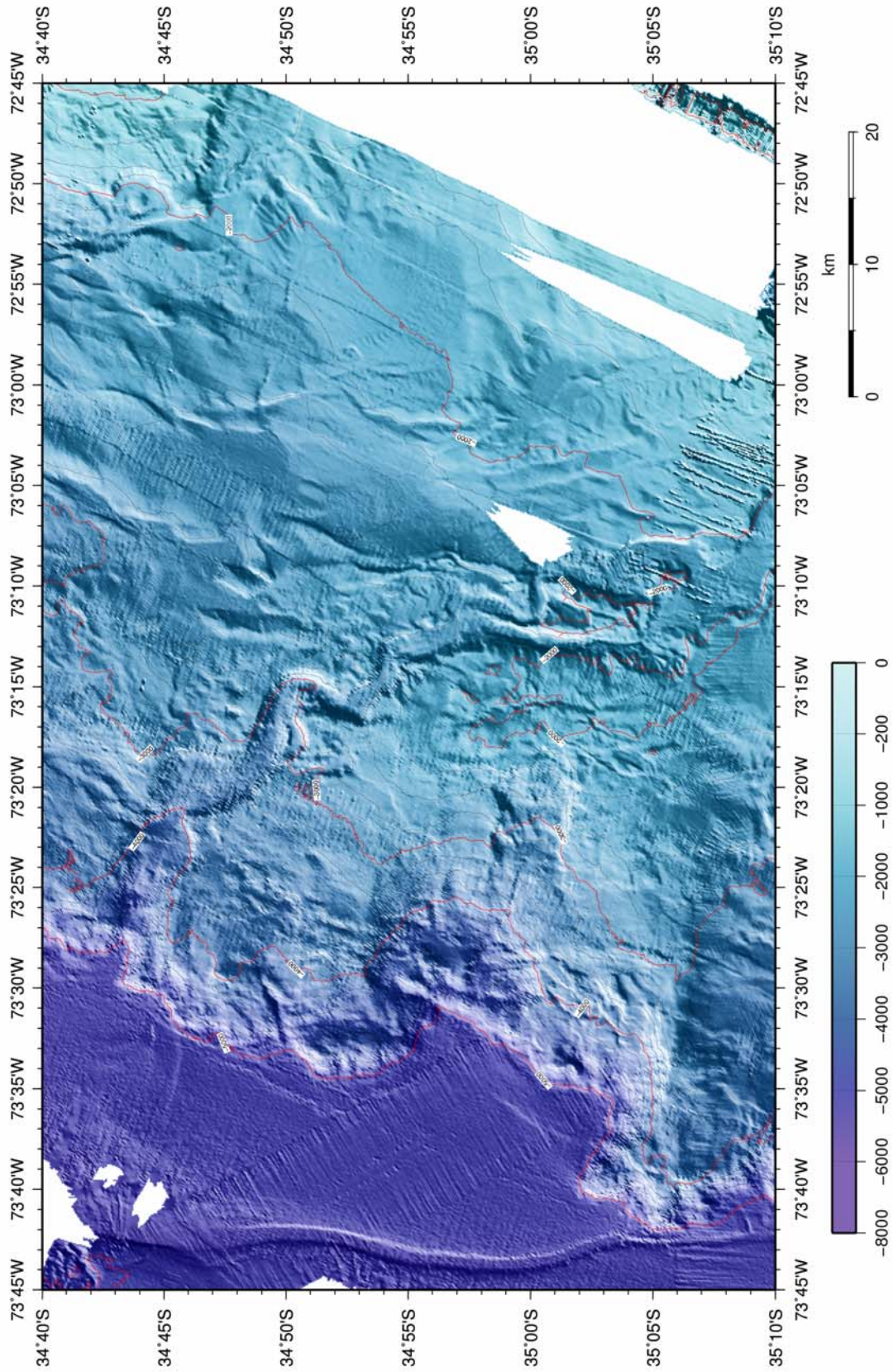

Figure 8.2.2.7 Colour-coded, shaded relief map of the bathymetry of the continental margin between 35°10'S and 34°40'S

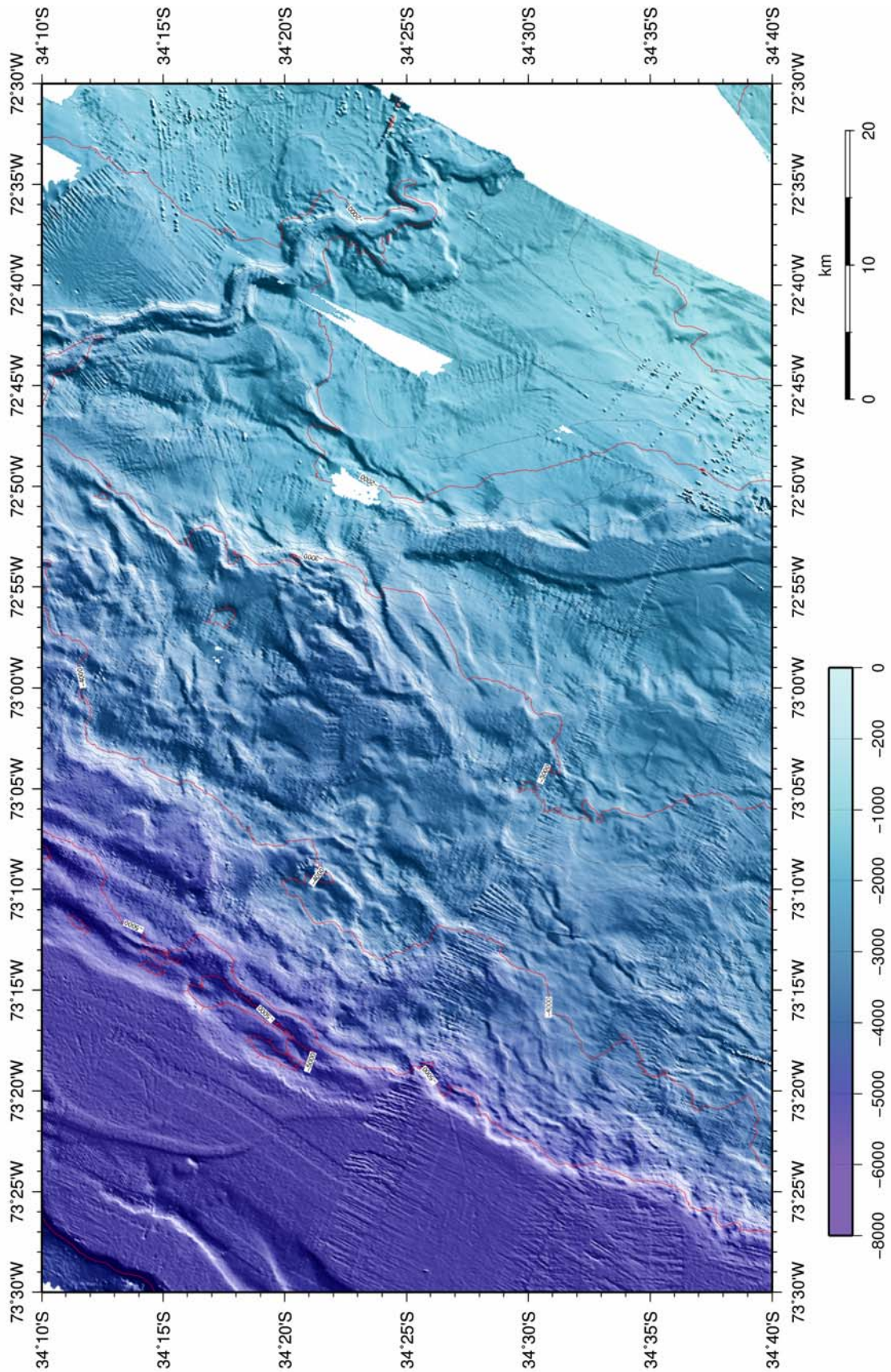

Figure 8.2.2.8 Colour-coded, shaded relief map of the bathymetry of the continental margin between 34°40'S and 34°10'S

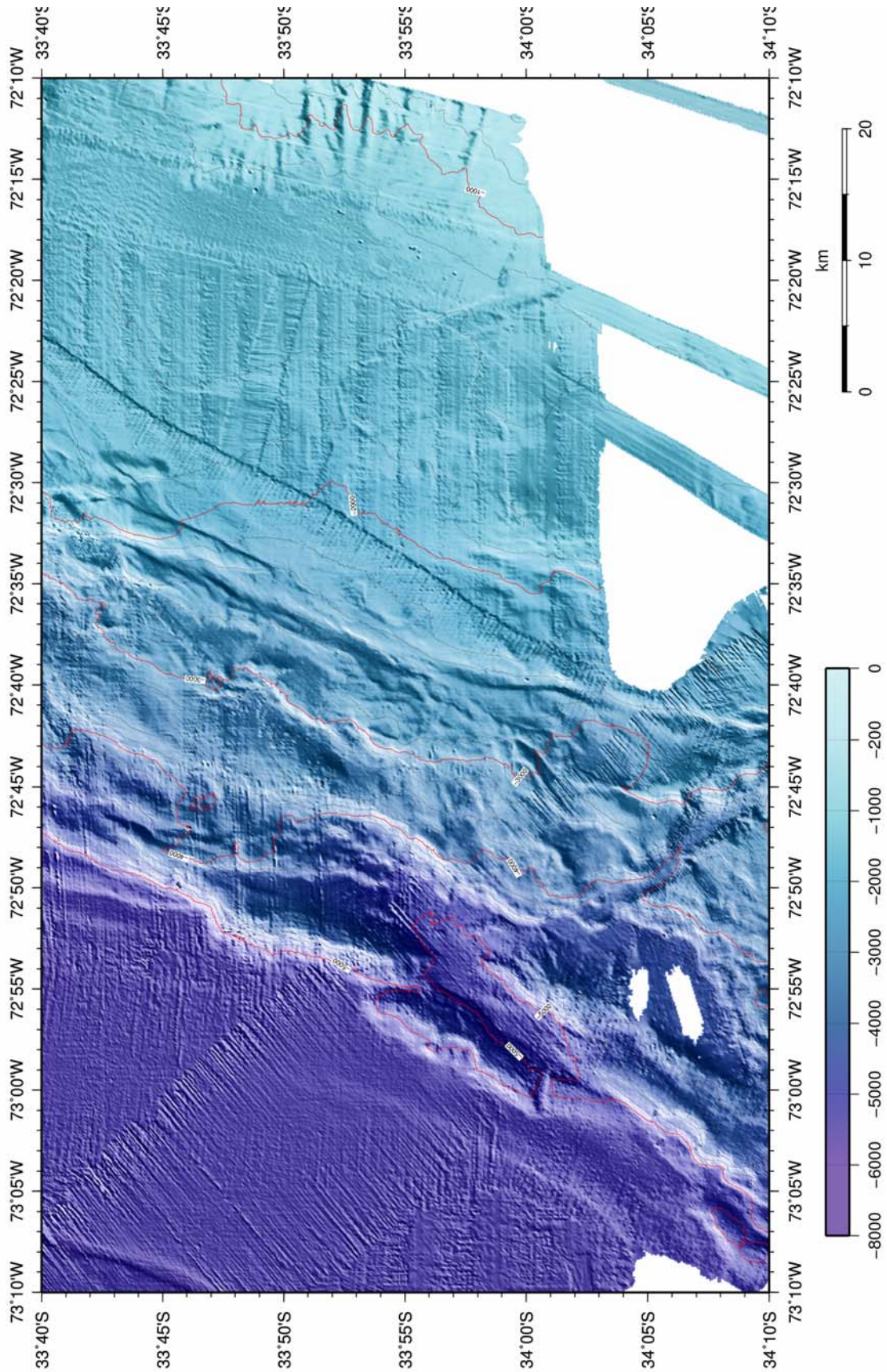

Figure 8.2.2.9 Colour-coded, shaded relief map of the bathymetry of the continental margin between 34°10'S and 33°40'S

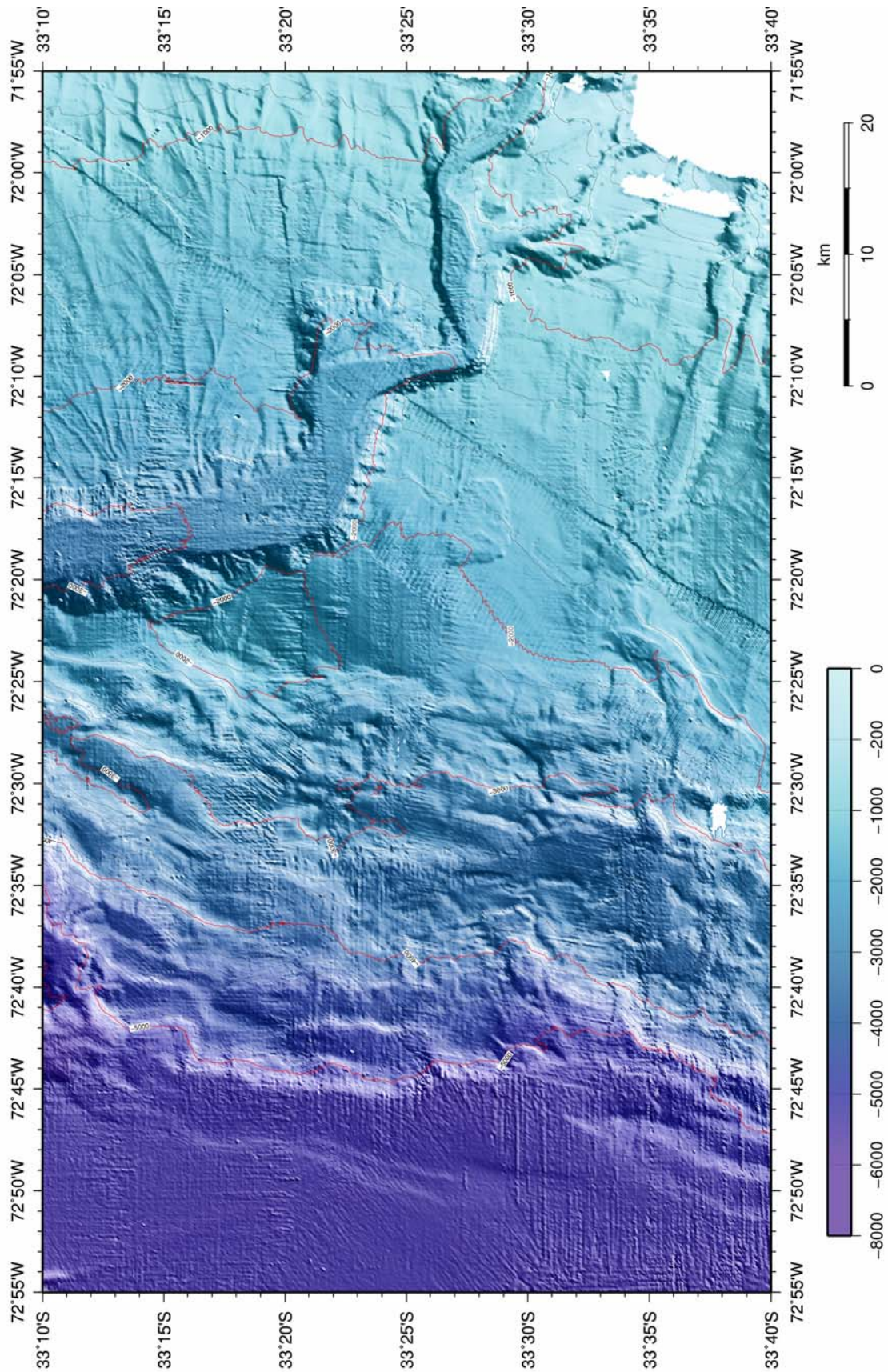

Figure 8.2.2.10 Colour-coded, shaded relief map of the bathymetry of the continental margin between 33°40'S and 33°10'S

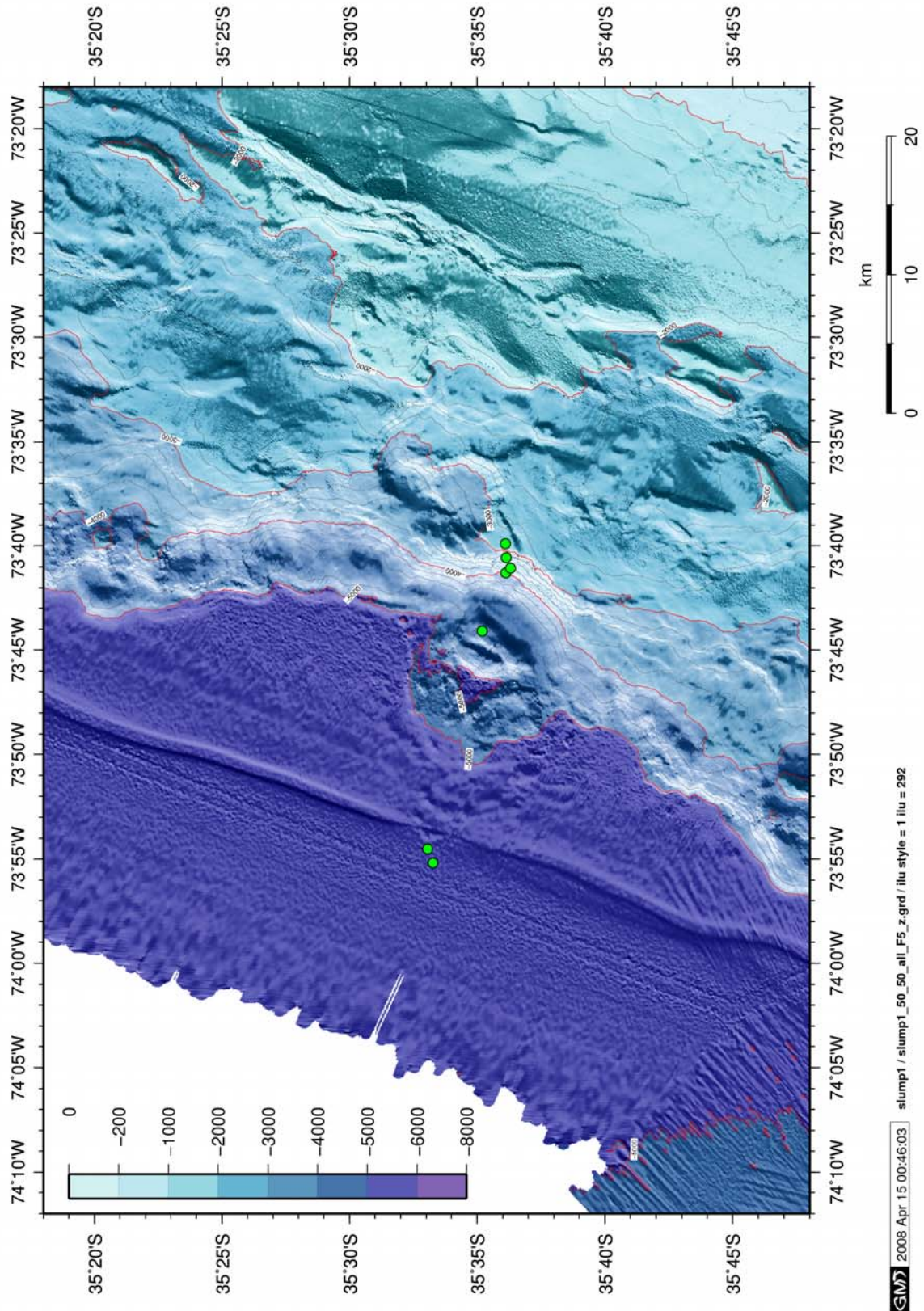

Figure 8.2.2.11 Colour-coded, shaded relief map of the bathymetry of the Roca slump and olistolith at the lower continental slope. The green dots mark positions of gravity cores taken

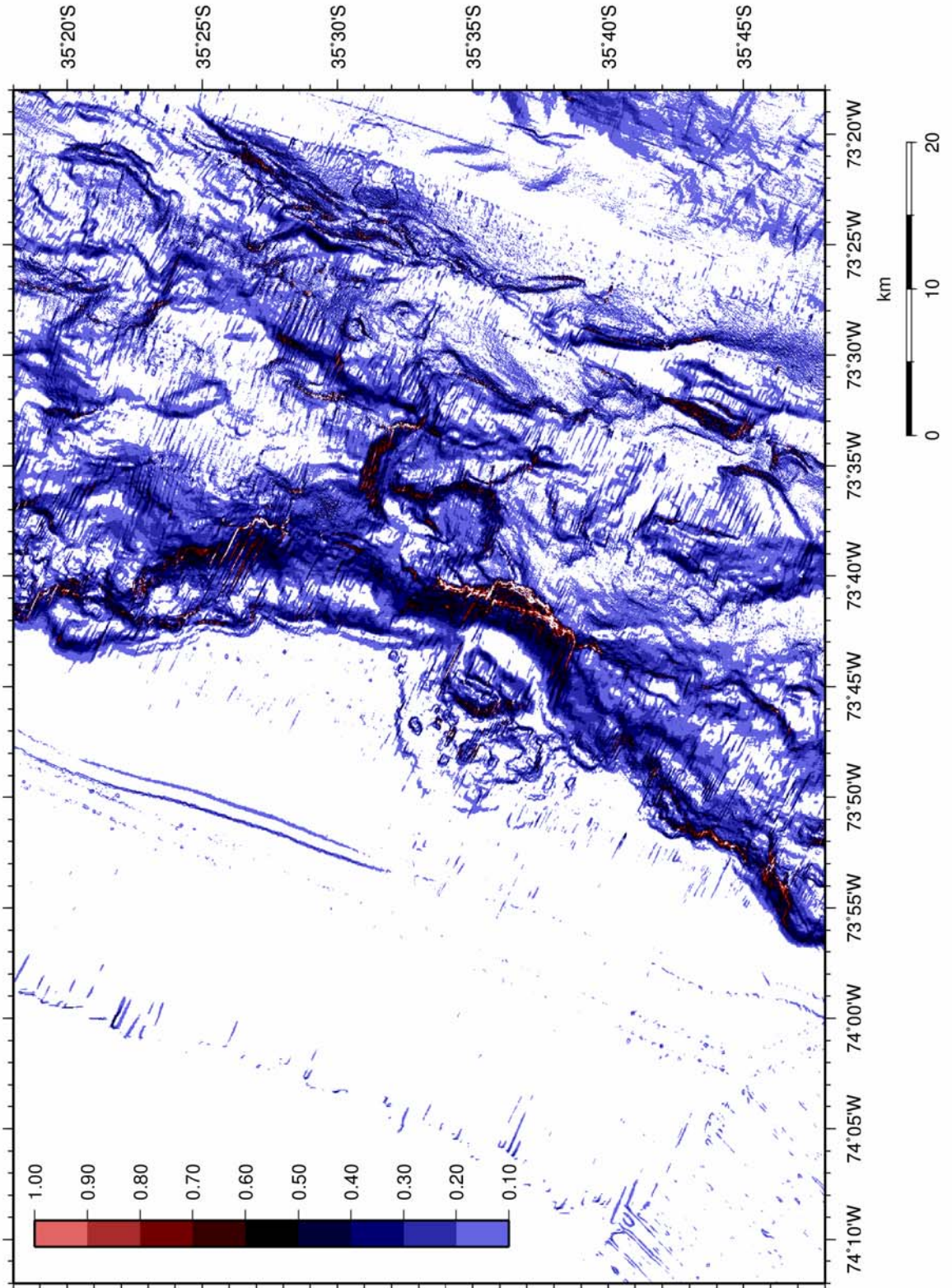

Figure 8.2.2.12 Slope map (maximum gradient of the digital terrain model) of the Roca slump and olistolith area

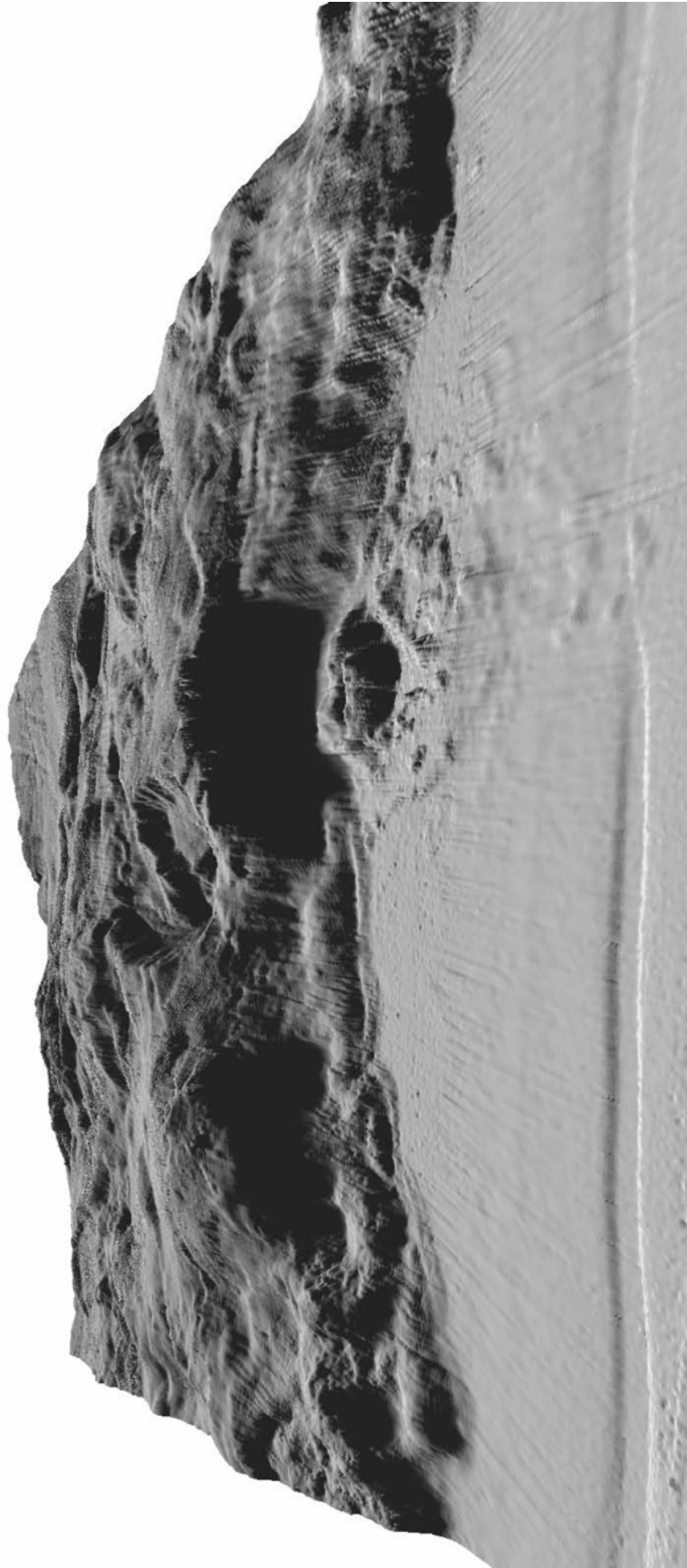

Figure 8.2.2.13 Perspective view of Roca slump, view from west

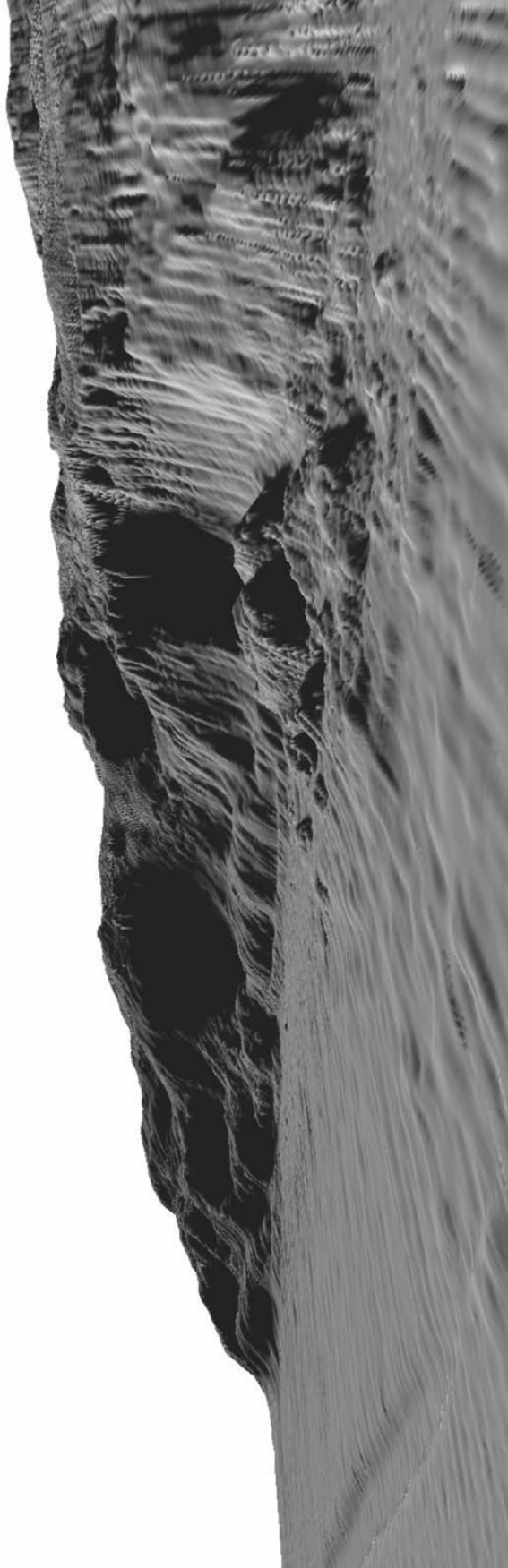

Figure 8.2.2.14 Perspective view of Roca slump, view from south-west

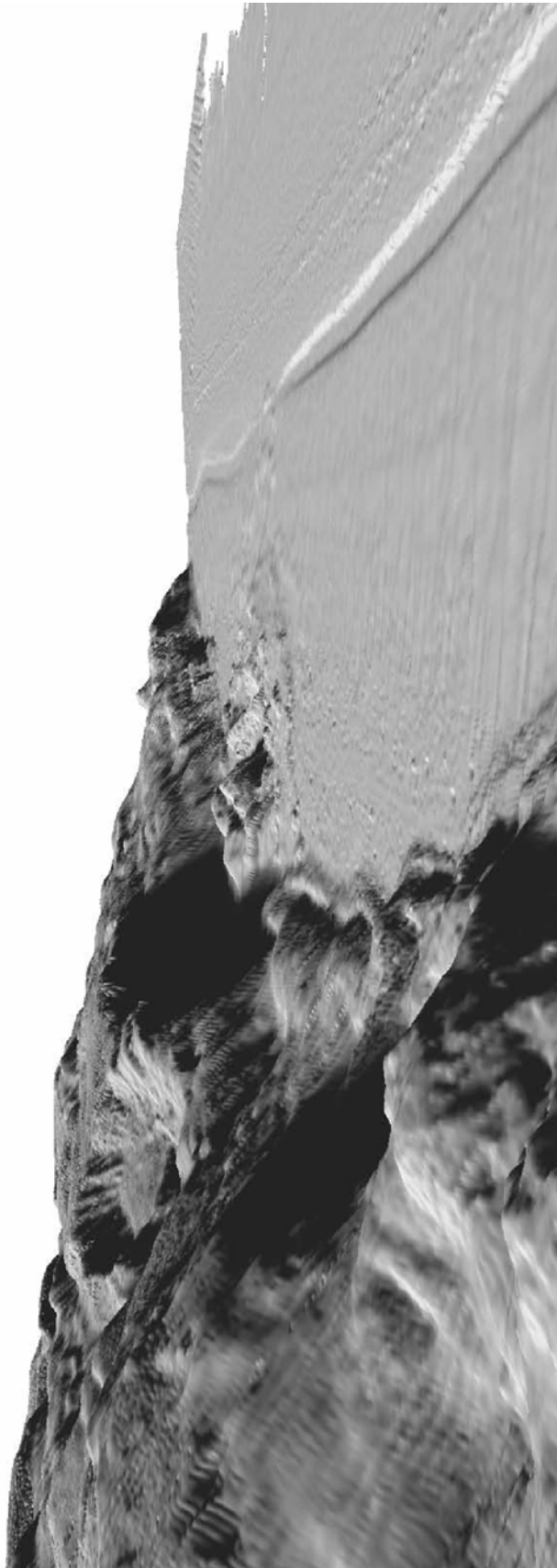

Figure 8.2.2.15 Perspective view of Roca slump, view from north.

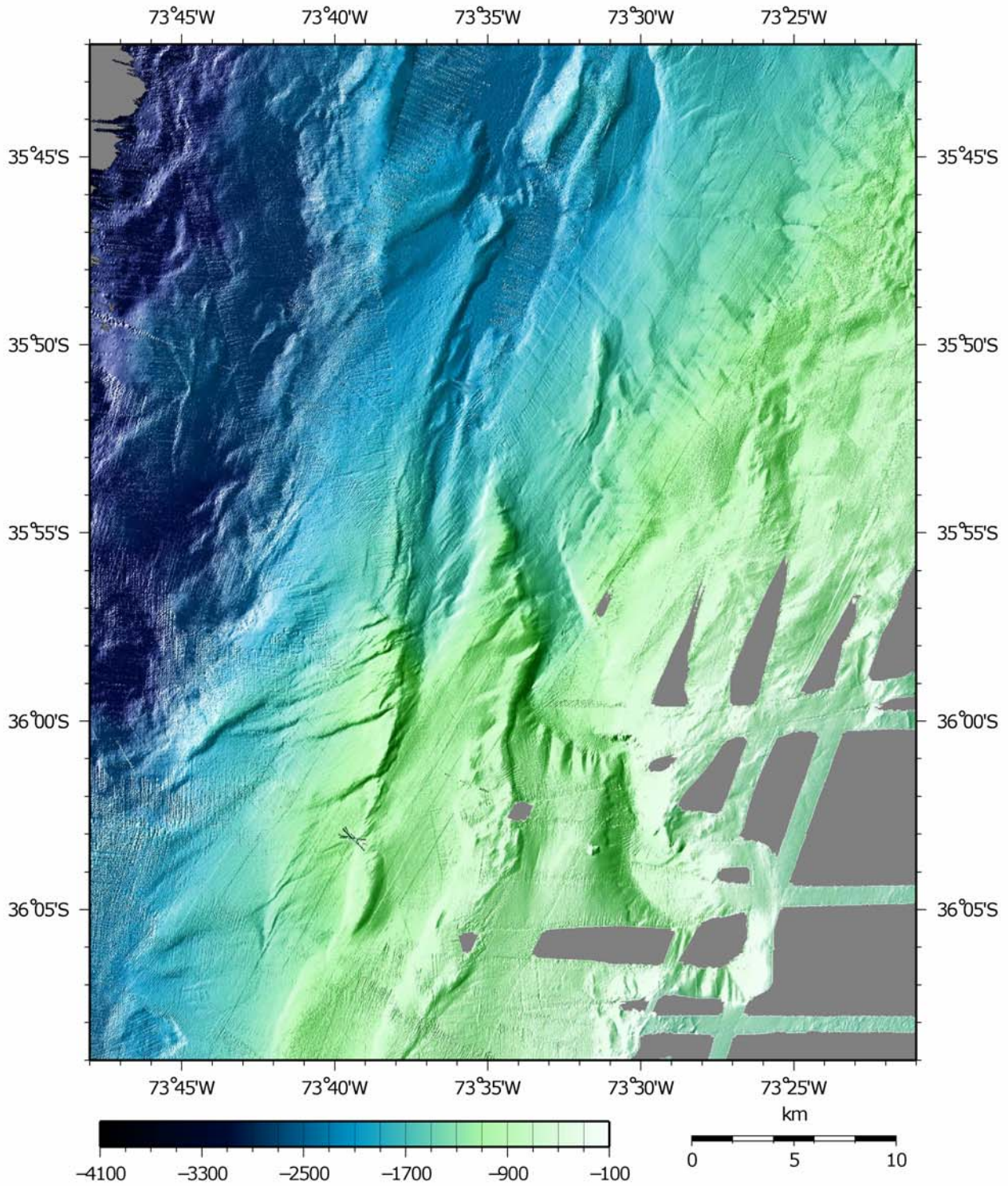

Figure 8.2.2.16 Colour-coded, shaded relief map of the bathymetry of the area of the DTS-1 survey 1 at the middle continental slope

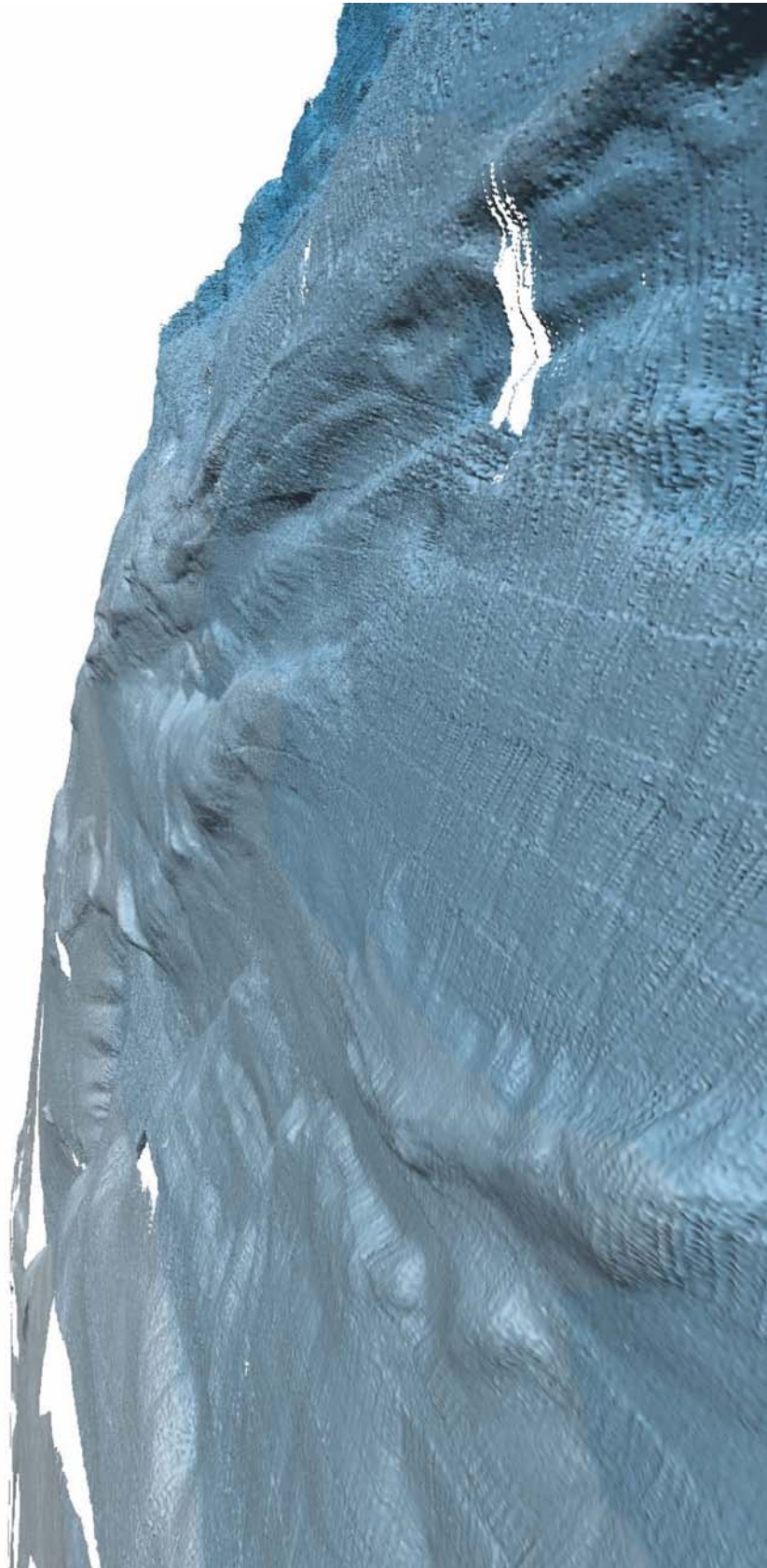

Figure 8.2.2.17 Perspective view of the area of the DTS-1 survey 1, view from north

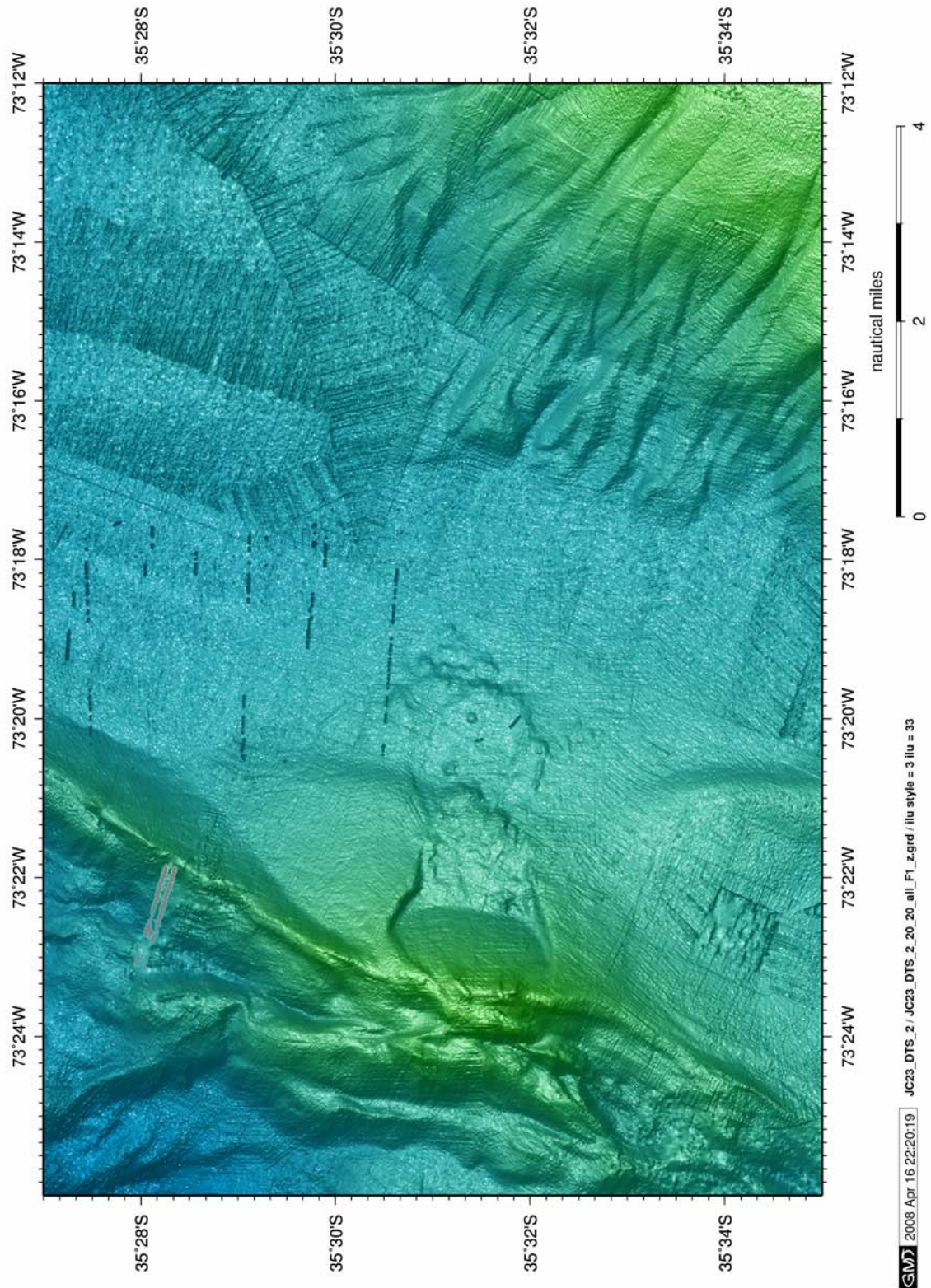

Figure 8.2.2.18 Colour-coded, shaded relief map of the bathymetry of the Valdes submarine landslide, the area of the DTS-1 survey 2 at the middle continental slope

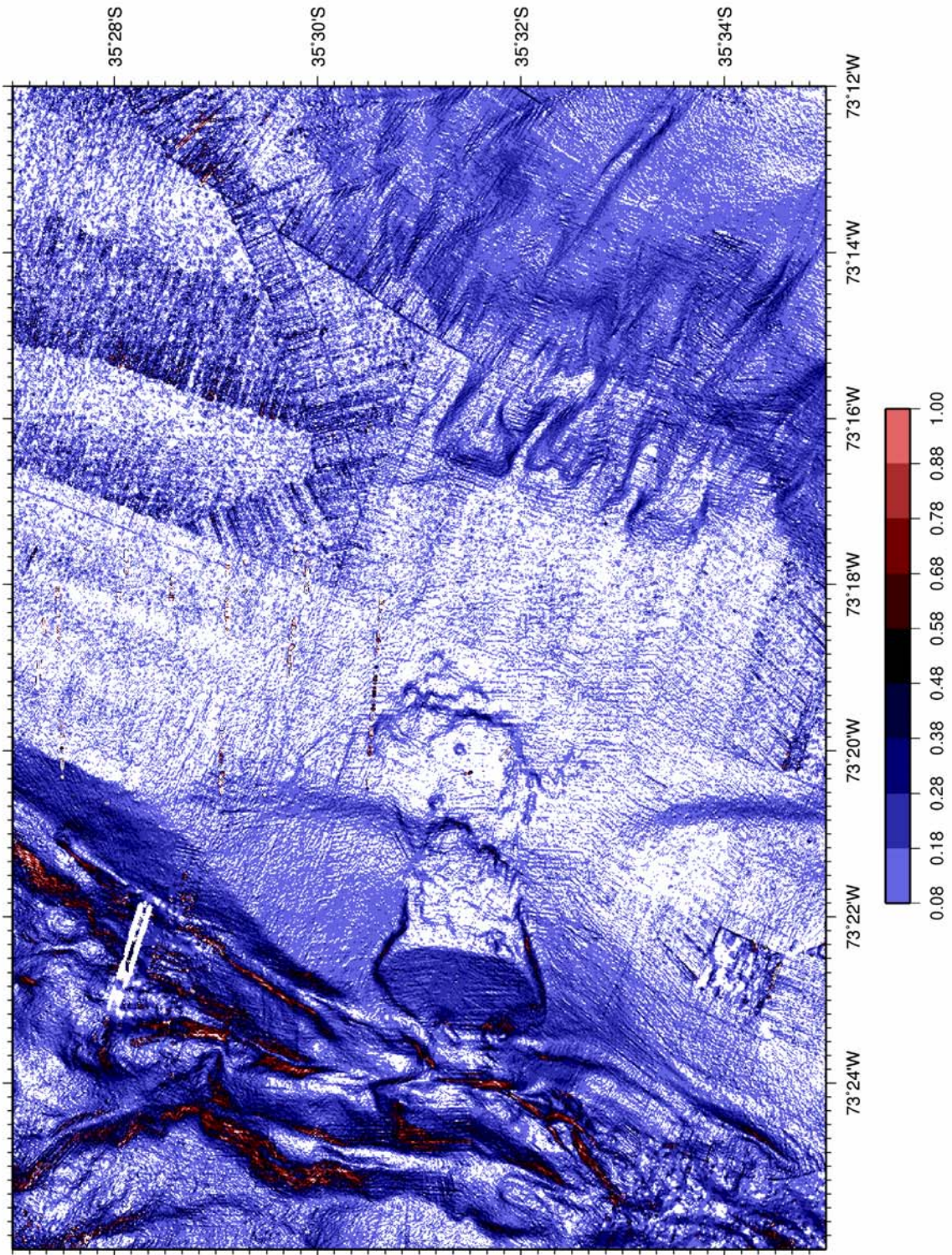

Figure 8.2.2.19 Slope map of the Valdes submarine landslide, the area of the DTS-1 survey 2 at the middle continental slope



Figure 8.2.2.20 Perspective view of the Valdes submarine landslide, view from east.

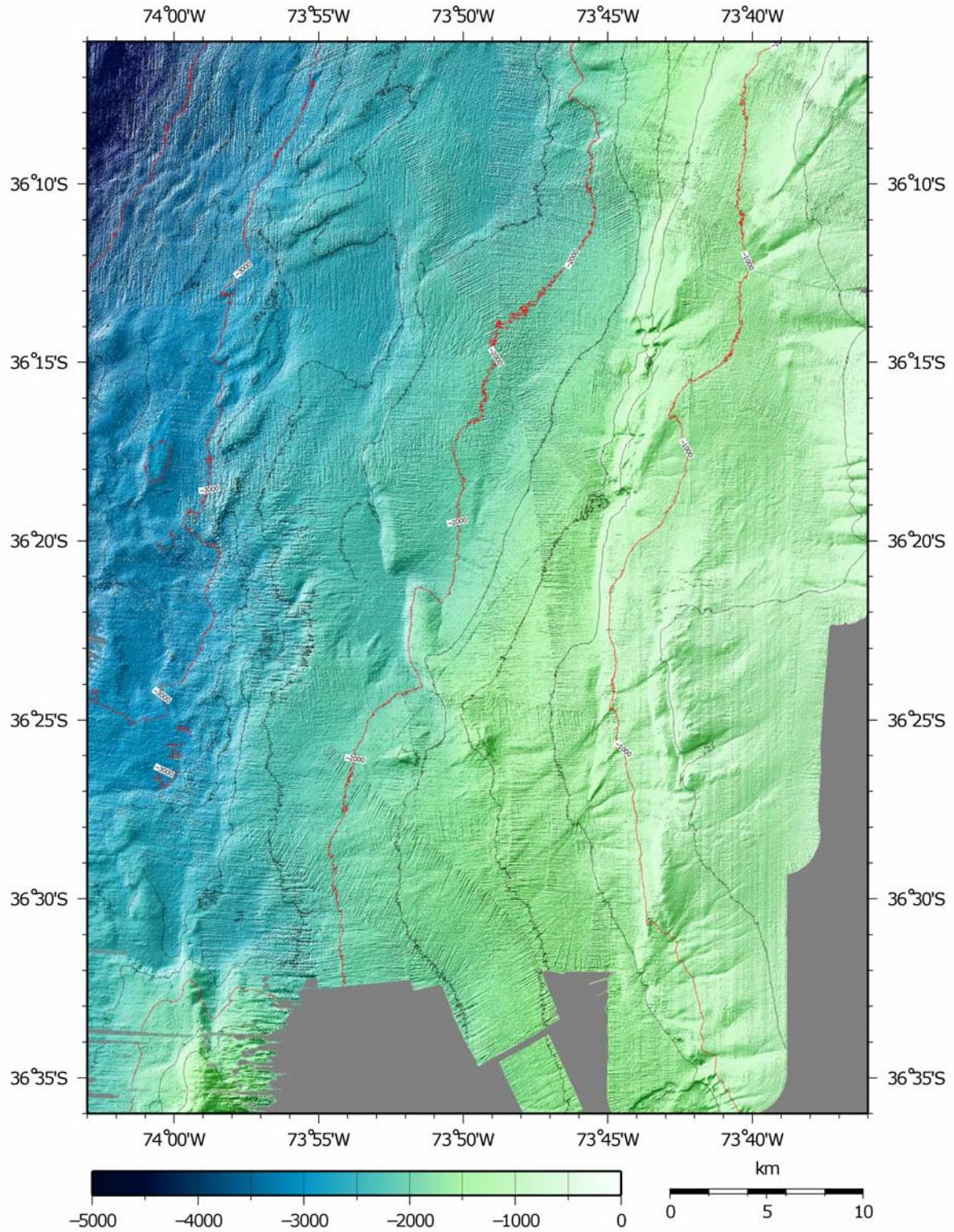

Figure 8.2.2.21 Colour-coded, shaded relief map of the bathymetry of the area of the DTS-1 survey 3 at the middle continental slope

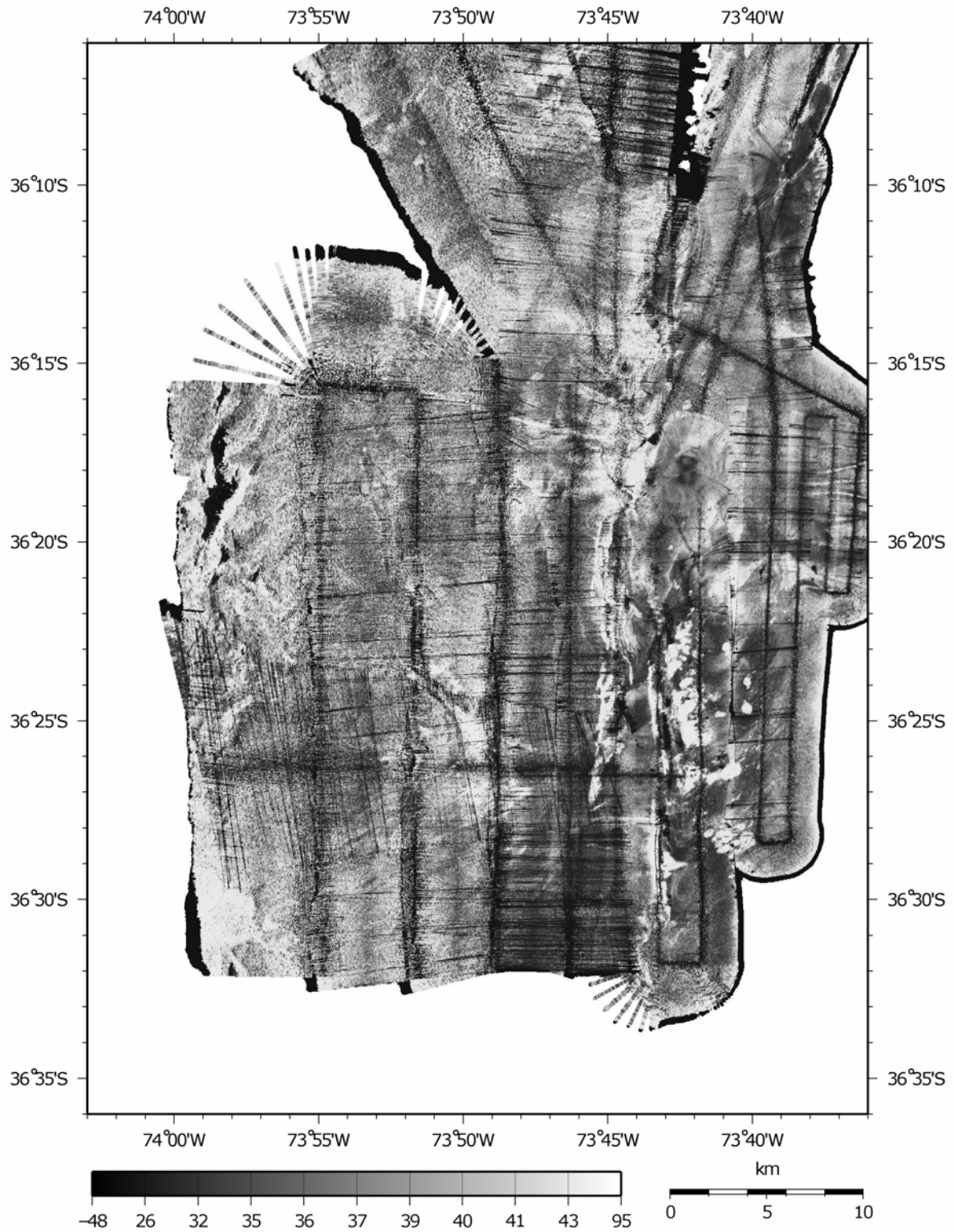

Figure 8.2.2.22 EM-120 „pseudo“-side-scan sonar image of the area of the DTS-1 survey 3 at the middle continental slope

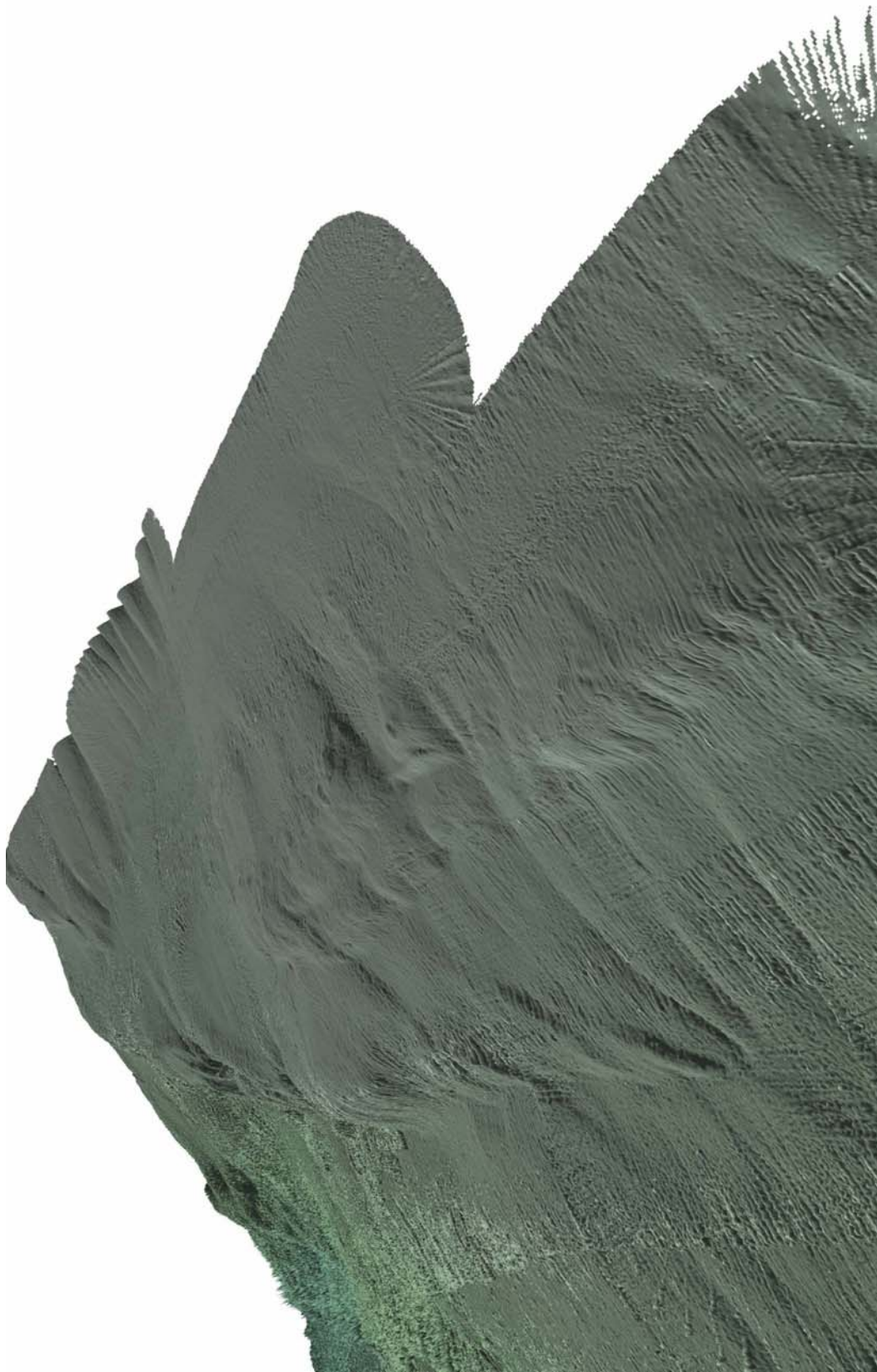

Figure 8.2.2.23 Perspective view of the area of the DTS-1 survey 3, view from south



Figure 8.2.2.24 Perspective view of the area of the DTS-1 survey 3, view from east



Figure 8.2.2.25 Perspective view of the area of the DTS-1 survey 3, view from east, EM-120-“pseudo”-side-scan data draped over the bathymetry

9. Magnetotelluric Instrumentation

Nine ocean bottom magnetotelluric measurements (OBMT) instruments were deployed on cruise JC 23-A (Fig 9.1). The instruments occupied a line which was extended across the margin with onshore installations. Instruments were recovered during leg B, but unfortunately one of the OBMT stations was lost due to unknown reasons (no reply on acoustic interrogation). Details on deployment and recovery are given in Appendix 15.5.

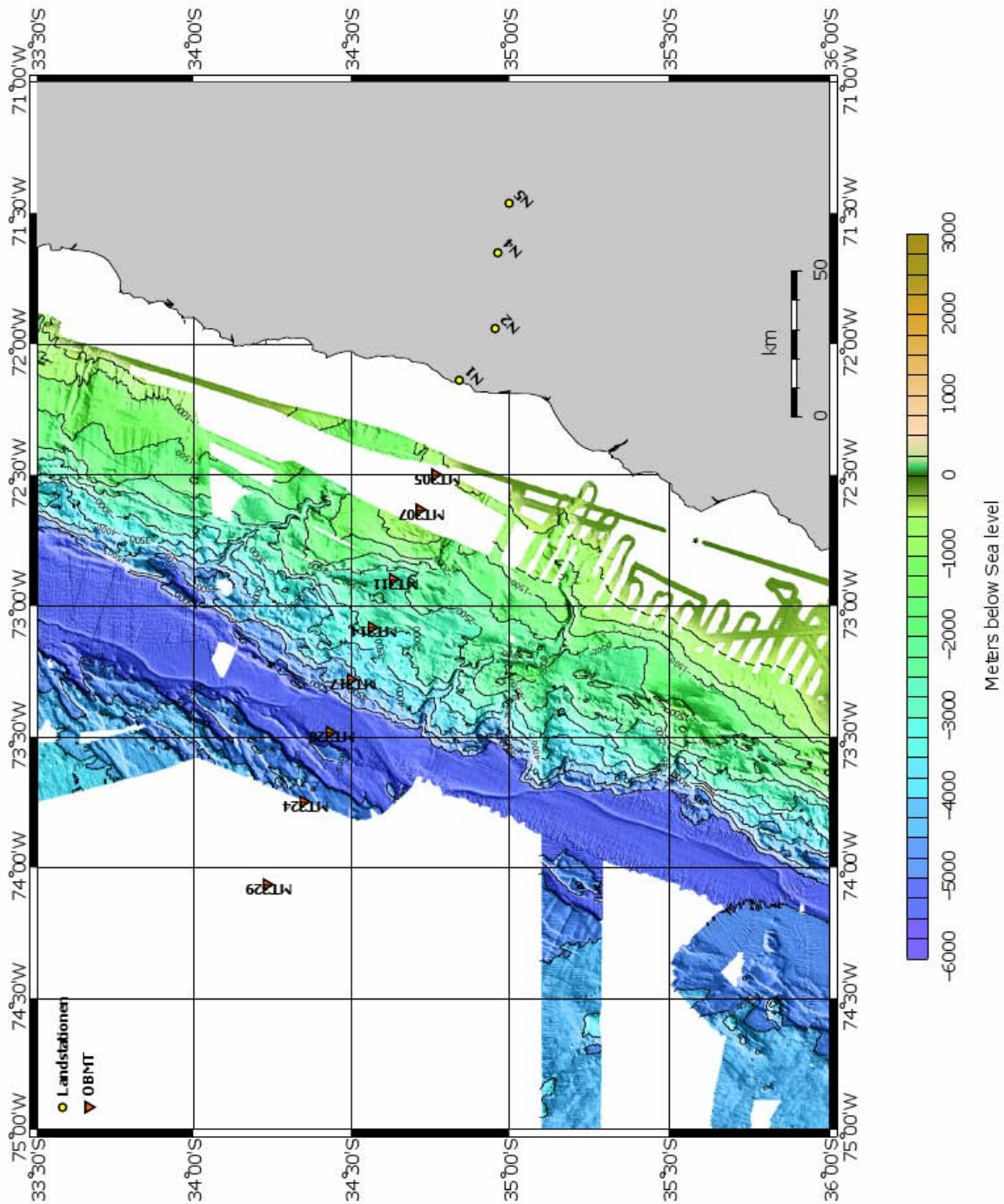

Fig. 9.1.: Location map of OBMT deployment. Bathymetry contours are at 500 m.

This instrument measures the natural temporal geomagnetic and geoelectric (telluric) field variations in a period range from $T = 0.2 \text{ s} - \text{DC}$ (possible sampling rates are 10Hz, 5Hz, 1Hz and 1/60Hz.). The OBMT-System is constructed at IFM-GEOMAR according to Ocean bottom seismometers. The recording instrument inside the Titanium cylinder is designed and constructed by *MAGSON GmbH* and contains:

- a three component fluxgate magnetometer,
- two E-field channels for recording the electric field in two components,
- a dual axes tilt meter for measuring pitch and roll,
- a realtime clock (RTC), and
- a temperature sensor.

The instrument is equipped with an internal data logger for instrument control and data storage on compact flash cards. The OBMT-System is a free falling system with a non-magnetic anchor made of aluminium and concrete to avoid distortion of data due to induction effects, and has an acoustic release for recovery. A photo showing the instrument upon deployment is shown in Fig. 9.2, a sketch is given in Fig. 9.3.

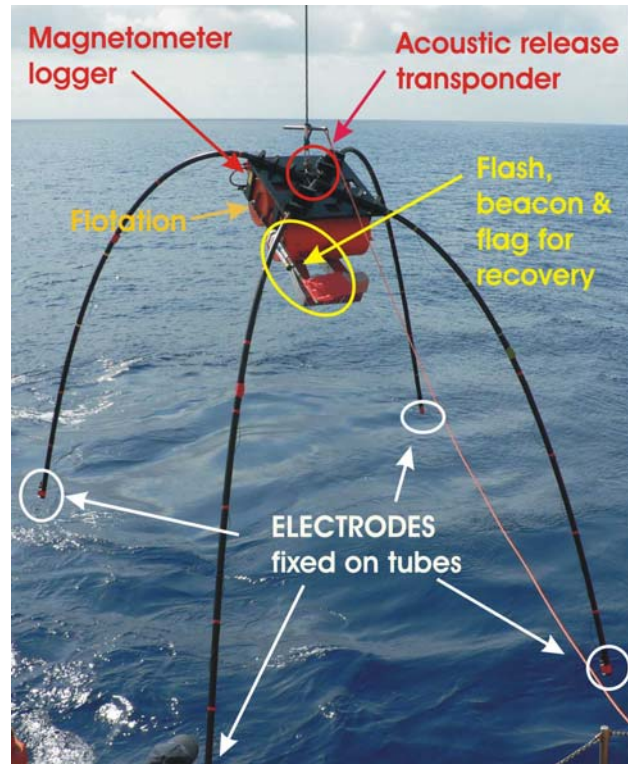

Fig.9.2.: OBMT Deployment

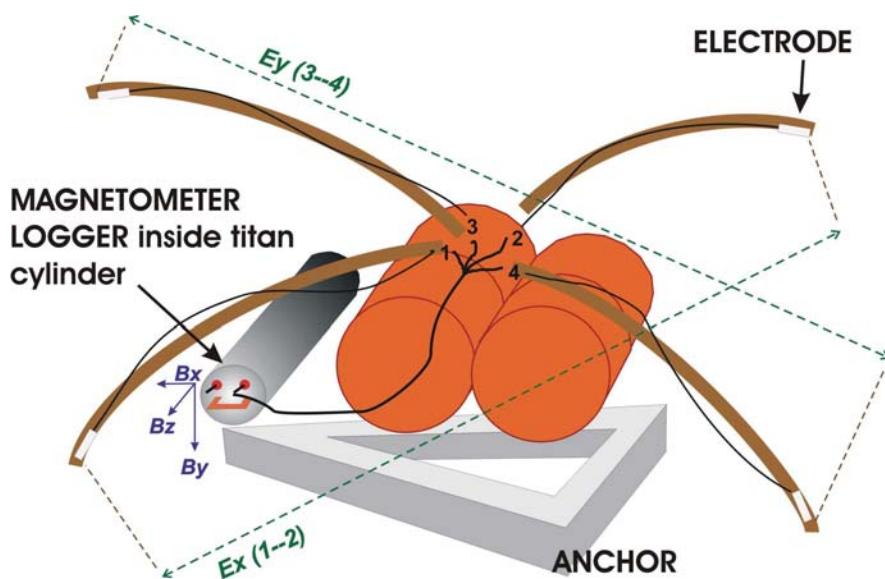

Fig.9.3: sketch of OBMT

Fluxgate Sensor:

The magnetic field is measured with a vector compensated ringcore fluxgate sensor. It consists of two crossed ringcores, three pick-up coils and a tri-axial Helmholtz coil system for field feedback. The vector compensation reduces the cross-field influence on the measurement. Scale values and non-orthogonality depend only on stability of the feedback coil system. Because of stable temperature conditions on seafloor, the use of the three component mini sensor without additional support materials is applicable. Thermal expansion coefficient of the feedback coil system is about 24ppm/°C. Noise level of ringcores is in the order of 10pT/ $\sqrt{\text{Hz}}$ @ 1Hz.

Digital Fluxgate Magnetometer Principle:

The main property of the digital fluxgate magnetometers is the direct digitization of the second harmonic of the excitation frequency, which contains the magnetic field information. Filters and phase-sensitive demodulators are not used. Analog-to-digital conversion close to the sensor reduces the amount of analogue parts, which often cause drift problems or show deviations in the component values, and it highly increases the robustness against environmental influences (e.g. temperature change and electromagnetic disturbances).

These considerations lead to the design of mainly digital sensor electronics. First, the sensor output (sense) signal is amplified by an instrumentation amplifier. Next, it is digitized by a 16-bit analogue-to-digital converter exactly in the minimum and maximum of the second harmonic of the excitation frequency. The FPGA (Field Programmable Gate Array) calculates the difference between both measurements and stores the result in an accumulator. This measurement will be repeated for a programmable number of excitation periods. A FPGA internal RISC (Reduced Instruction Computer) processor calculates from the accumulated ADC (Analog/Digital Converter) values and the last set DAC (Digital/Analog Converter) feedback value the magnetic field value, transmits the results to the data logger and calculate a new set of DAC feedback values. The feedback system is driven by two 16bit DA-Converters for each component, the first one to compensate the Earth's field and the second one to operate the sensor in a reduced range. Therefore two measurement modes are available. The full range mode covers the whole Earth's magnetic field range and the variometer mode works in a limited range of +/-2.000nT. The reason to separate the field compensation into coarse and fine range is the differential nonlinearity (DLN) of the DA-Converter. Reduced operation range in variometer mode guarantees, that nonlinearity is smaller than the resolution. Using a higher internal sampling rate and cascaded DA-Conversion the dynamic range corresponds with 24bit. The resolution on the background of the Earth's field is still 10pT.

Ocean Bottom MT electronics:

The electronics consists of magnetometer electronics, electric (E-) field measurement, tilt and temperature measurement and the data logger with real time clock (RTC) and power management. B- and E- field will be measured in time synchrony, triggered by the 1Hz signal of the RTC. The internal data acquisition rate is 100Hz. Dependent on the selected storage frequency, data output as well as system time, inclination, temperature and instrument status are stored on the flash disk. Furthermore, data logging and instrument control with an external unit via RS232 is possible.

Optionally, a time table may be programmed to determine settings of mode, sampling rate and format for any time chosen. This option allows, as an example, a broadband recording at shallower depth from high frequent sampling in the beginning switching automatically to long period measurements, since it may save disk capacity and battery.

Electric field sensors

Electric field fluctuations are determined by measuring the potential difference (U) between pairs of electrodes, which are connected via shielded cable to form a dipole and fixed nearby the ground at known distances (d) round about 10m apart: $E=U/d$.

In this system we use 4 unpolarizable Ag-AgCl electrodes for probing the electric field (2x two dipoles). Two dipoles are required in order to ascertain the two horizontal components of the electric field. They are configured orthogonal to each other being fixed to four tubes of each 5 m length (see fig.9.2).

Technical data:***Magnetic (B) –Field***

sensor type: 3- component fluxgate, vector compensated
 Feedback coil system: Self-supported sensor construction
 expansion coefficient: 24ppm/°C
 dimensions: height 4cm, diameter: 5cm
 Sensor weight: 50 g
 orientation: orthogonal (X,Y,Z)
 Measurement ranges:
 -full range mode: $\pm 60.000\text{nT}$ / DNL: 350pT
 -variometer mode: $\pm 2.000\text{nT}$ / DNL: 20pT
 resolution: 10pT
 noise: $< 10\text{pT/Hz}$ @1Hz
 long term stability: $< 10\text{nT/Year}$
 linearity: $< 0.002\%$
 offset drift $< 1\text{nT/}^\circ\text{C}$ in Earth field $< 0.05\text{nT/}^\circ\text{C}$ in reduced field

Electric (E) –Field

ranges: $\pm 1,25\text{V}$ Gain 1 & $\pm 20\text{mV}$ Gain 64
 ADC: 24 Bit with programmable Gain
 noise: $< 10\text{nV}/\sqrt{\text{Hz}}$ @ 1Hz
 (short circuit without electrodes)

Tilt

sensor type: spectron SSY0091P
 range: ± 20 degrees
 accuracy: $\pm 0,6$ degree

Temperature

range / resolution: -50 & $+100^\circ\text{C}$ / $0,1^\circ\text{C}$

RTC

Dallas RTC:
 power consumption accuracy: $50\mu\text{W}$ 2ppm
 Seascan based module:
 power consumption accuracy: (optional / under development) 25mW 0,1ppm

Data Logger

mass storage: Compact flash up to 8GByte
 storage frequency: 10, 5, 1 and 0,1 Hz
 interface: RS232, 38.400Baud, ASCII

10. Sidescan sonar operations

Objectives

Deployments of the DTS-1 sidescan sonar offshore Chile were targeted at two different objectives. Based on information from previous cruises and Chilean colleagues several areas on mid-continental slope have been mapped in order to identify and image fluid-escape structures. In addition, one submarine landslide occurring at the seaward margin of a mid-slope basin has been mapped as well.

Methods

These fluid-escape structures and submarine landslides have been mapped using the DTS-1 sidescan sonar system (Fig. 10.1) operated by IfM-GEOMAR. The DTS-1 sidescan sonar is a dual-frequency, chirp sidescan sonar (EdgeTech Full-Spectrum) working with 75 and 410 kHz centre frequencies. The 410 kHz sidescan sonar emits a pulse of 40 kHz bandwidth and 2.4 ms duration (giving a range resolution of 1.8 cm), and the 75 kHz sidescan sonar provides a choice between two pulses of 7.5 and 2 kHz bandwidth and 14 and 50 ms pulse length, respectively. They provide a maximum across-track resolution of 10 cm. With typical towing speeds of 2.5 to 3.0 kn and a range of 750 m for the 75 kHz sidescan sonar, maximum along-track resolution is on the order of 1.3 metres. In addition to the sidescan sonar sensors, the DTS-1 contains a 2-16 kHz chirp subbottom profiler providing a choice of three different pulses of 20 ms pulse length each. The 2-10 kHz, 2-12 kHz or 2-15 kHz pulse gives a nominal vertical resolution between 6 and 10 cm. The sidescan sonar and the subbottom profiler can be run with different trigger modes, internal, external, coupled and gated triggers. Coupled and gated trigger modes also allow specifying trigger delays. The sonar electronics provide four serial ports (RS232) to attach up to four additional sensors. One of these ports is used for a Honeywell attitude sensor providing information on heading, roll and pitch and a second port is used for a Sea&Sun pressure sensor. Finally, there is the possibility of recording data directly in the underwater unit through a mass-storage option with a total storage capacity of 30 GByte (plus 30 Gbyte emergency backup).

The sonar electronic is housed in a titanium pressure vessel mounted on a towfish of 2.8 m x 0.8 m x 0.9 m in dimension (Fig. 10.1). The towfish houses a second titanium pressure vessel containing the underwater part of the telemetry system (SEND DSC-Link). In addition, a releaser capable to work with the USBL positioning system POSIDONIA (IXSEA-OCEANO) with separate receiver head, and an emergency flash and radio beacon (NOVATECH) are included in the towfish. The towfish is also equipped with a deflector at the rear in order to reduce negative pitch of the towfish due to the weight of the depressor and buoyancy of the towfish. During cruise JC23B the POSIDONIA USBL system was not available as the portable antenna could not be fixed to the ship. A different USBL tracking system from Sonardyne was used instead and an additional transponder had to be mounted at the front of the towfish. This additional weight has been compensated for by pieces of syntactic foam, but the towing and stability behaviour of the towfish has been altered by these transformations.

The towfish is connected to the sea cable via the depressor through a 45-m long umbilical cable (Fig. 10.2). The umbilical cable is tied to a buoyant rope that takes up the actual towing

forces. An additional rope has been taped to the buoyant rope and serves to pull in the instrument during recovery.

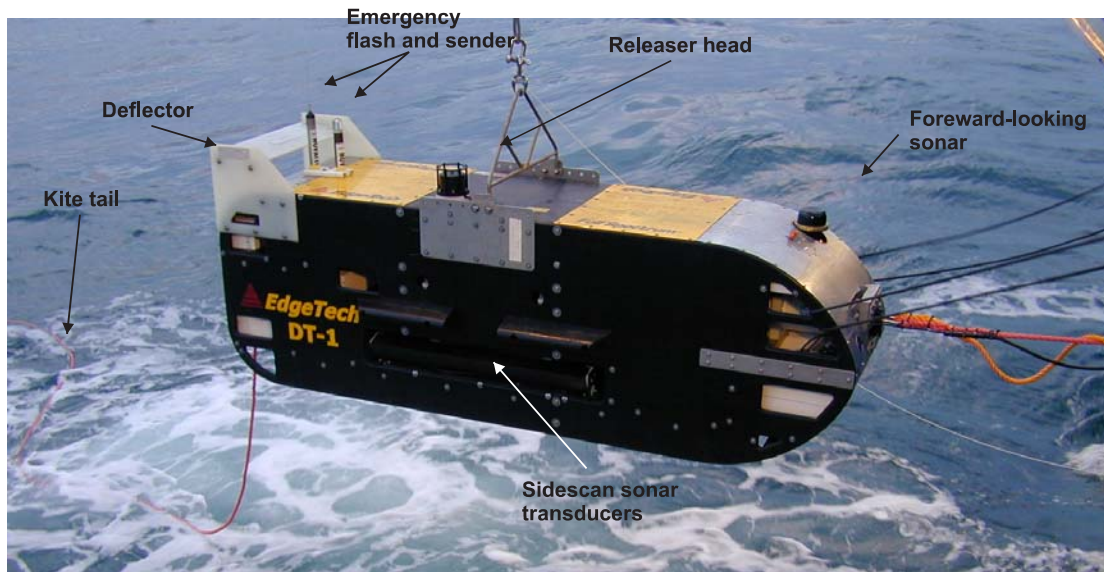

Figure 10.1: A picture of the DTS-1 sidescan sonar towfish. The forward-looking sonar is no longer mounted.

The main operations of the DTS-1 sidescan sonar are run using HydroStar Online, the multibeam bathymetry software developed by ELAC Nautik GmbH and adapted to the acquisition of EdgeTech sidescan sonar data. This software package allows onscreen presentation of the data, of the tow fish's attitude, and the tow fish's navigation when connected to the POSIDONIA USBL positioning system. It also allows setting the main parameters of the sonar electronics, such as selected pulse, range, power output, gain, ping rate, and range of registered data. HydroStar Online also allows activating data storage either in XSE-format on the HydroStar Online PC or in JSF-format underwater on the full-spectrum deep-water unit FS-DW. Simultaneous storage in both XSE and JSF-formats is also possible. Accessing the underwater electronics directly via the surface full-spectrum interface-unit FS-IU and modifying the sonar.ini file of the FS-DW allows changing additional settings such as trigger mode. The FS-IU also runs JStar, a diagnostic software tool that also allows running some basic data acquisition and data display functions. HydroStar Online creates a new XSE-file when a file size of 25 MB is reached, while a new JSF-file is created every 40 MB. How fast this file size is reached depends on the amount of data generated, which depends on the use or not use of the high-frequency (410 kHz) sidescan sonar. The amount of data generated is also a function of the sidescan sonar and subbottom pulses and of the data window that is specified in the initialisation file (sonar.ini) on the FS-DW. The data window specifies the range over which data are sampled.

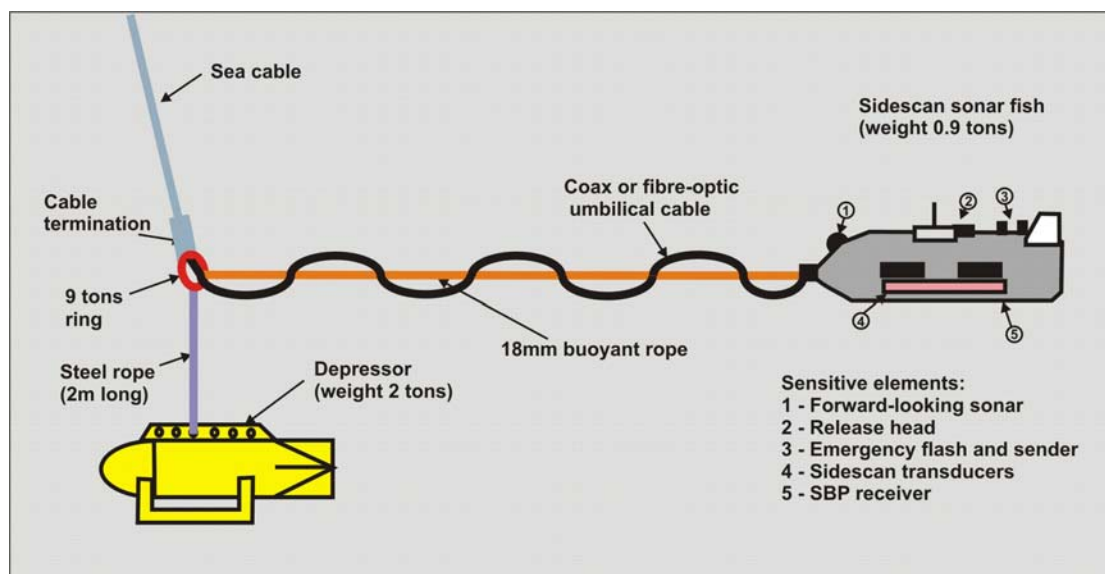

Figure 10.2: *The DTS-1 towing configuration.*

The subbottom profiler data have to be corrected for varying water depths in which the towfish is flying. These corrections are based on depth information provided by the pressure sensor mounted on the towfish and have been carried out with in-house processing scripts based on GMT and Seismic Unix software packages.

Deployments

The first deployment of the DTS1 system lasted from March 30, 13:00 UTC to April 2, 02:00 UTC and was designed to image an area where previous seismic surveys have suggested the presence of mud volcanoes and diapiric structures. The deployment consisted of five 20 miles long, parallel profiles running roughly NNE-SSW obliquely crossing several ridges on the continental slope in about 1500 metres water depth (Fig. 8.2.2.16). The last of these profiles has been extended for another 20 miles along the slope in a south-easterly direction. This survey had to be interrupted after the first profile at March 30, 23:30 UTC, because of a failure of the control PC running the deep-towed seismic streamer. This failure also resulted in frequent losses of the connexion to the towfish and irregular triggering of the sidescan sonar pings. The towfish was recovered, the telemetry system changed against a spare version running without the control PC for the seismic streamer and re-deployed at March 31, 02:00 UTC. The data of the first profile have been uploaded from the back-up in the towfish after the deployment, a process through which data gaps have been eliminated. Unfortunately, two problems affecting tow-fish navigation occurred during this deployment. The Sonardyne USBL system worked fine, but failed to export and log the data in a readable format. Consequently, no USBL navigation is available for this deployment and towfish navigation has to rely on a layback method using the length of the tow-cable. The second problem is a time-shift of exactly two hours between the navigation data and the ping times. This time-shift is likely due to an incompatibility between the version of HydroStar (version 3.3.4) running during this survey and Windows XP. By using an old computer running Windows NT this problem has been overcome during subsequent surveys. Parts of the profiles were also affected by electrical noise appearing first for extended periods lasting several tens of minutes and then at regular intervals and whose origin could not be determined.

The second deployment targeted a submarine landslide (Valés slump) situated along the seaward (western) margin of a vast intra-slope basin (Fig. 8.2.2.18) lasted from April 8, 2008 at 12:30 UTC until April 9, 2008 at 17:00 UTC. This survey consists of five parallel profiles running East-West along the axis of an eastward dipping submarine slide in 1300-1700 metres water depth. Two additional N-S profiles crossed the presumed main depositional area of the slide. USBL navigation data are available for part of this survey, but the Sonardyne system was not running stable and the accuracy of some of the data points is questionable.

The third and last deployment was targeted at an area east of the southern end of the first deployment, where several interesting high backscatter patches had been identified and where bathymetric data showed the presence of several, small but aligned elevations and cross-cutting canyons or fault traces (Fig. 8.2.2.21). This survey lasted from April 12, 2008 at 07:30 UTC until April 14, 2008 at 00:30 UTC and consists of six, parallel, 15 miles long, N-S running profiles. Again USBL navigation was not running correctly during this survey. This is particularly unfortunate as the ship had once to deviate from the intended course in order to avoid a fishing vessel and layback methods only give good results during straight lines.

Preliminary results

The sidescan sonar data were processed onboard using the Caribes software package developed by IFREMER. This software package together with navigation based on cable length using a layback method allows quick and reliable georeferencing of the sidescan sonar images for subsequent sampling or first analysis onboard.

Northern area

Although previous surveys suggested several indications for fluid-escape structures such as possible mud volcanoes seen on seismic profiles and various seep fauna recovered in geological dredges, the sidescan sonar data from the area do not show indications for active cold seeps. Much of the surveyed area shows uniform low backscatter intensity. High backscatter is either associated with two prominent ridges running obliquely to the survey area or rough canyon floors. In addition, the northern end of the survey area shows two deeply incised linear depressions of only a few tens of metres in width that could either represent deeply cut canyons or extensional faults (Fig. 10.5.). Although fault traces are known to host cold seep sites, such as offshore Costa Rica, no indications for increased backscatter have been observed in this area offshore Chile. The southern extension of profiles 5 finally showed indications for cold seeps in form of circular to elongated areas of increased backscatter intensity (Fig. 10.6) that could represent authigenic carbonate pavements on or gas-charged sediments near the seafloor. Based on these findings the layout for the third deployment of DTS-1 has been planned. The positioning of the sidescan sonar data, however, has to be taken with great caution due to the time shift mentioned earlier. Subsequent processing will have to carefully compare the sidescan sonar data with bathymetric information in order to manually adjust the towfish navigation if necessary.

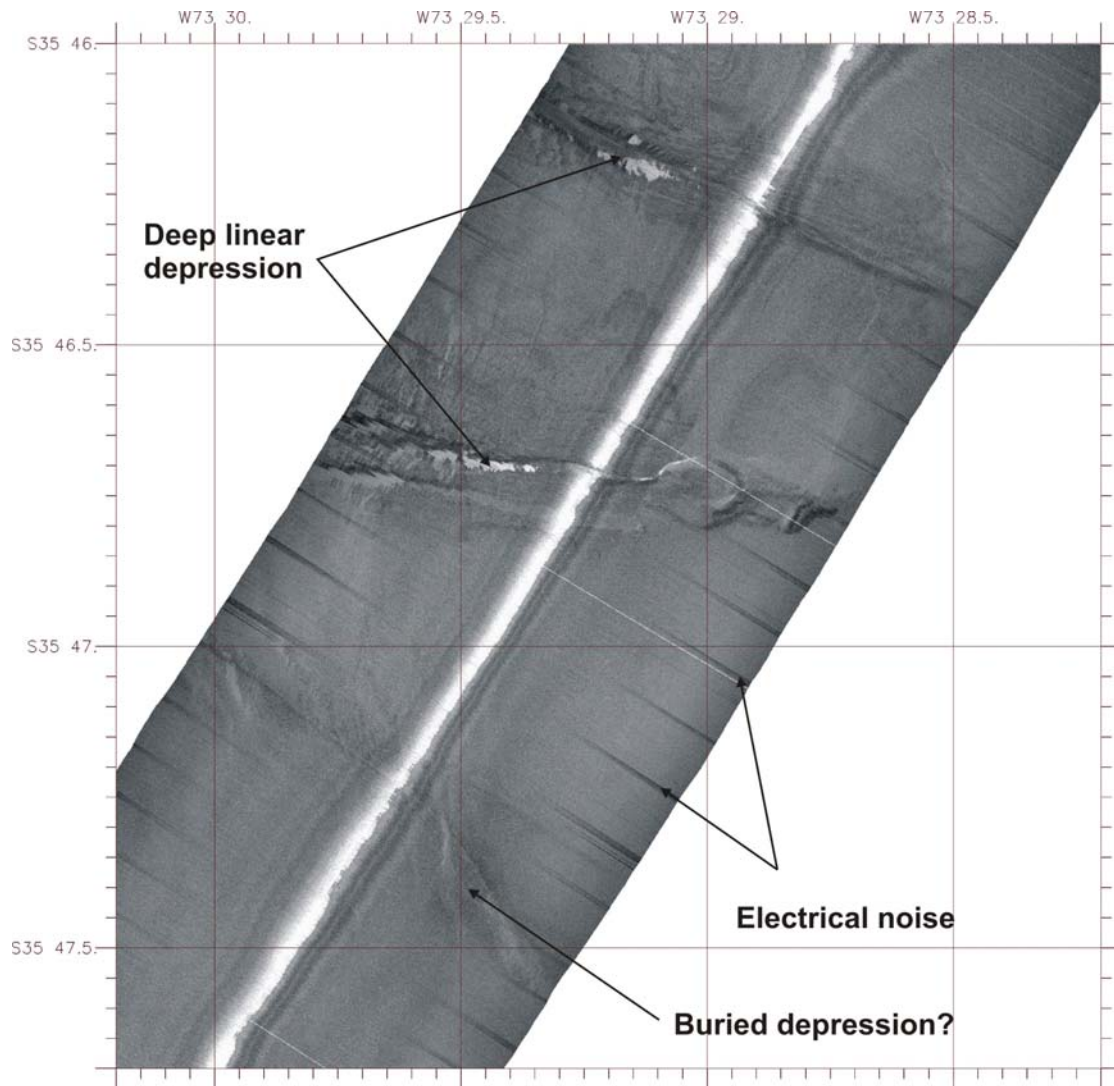

Figure 10.5: 75 kHz sidescan sonar profile showing fairly narrow incised depressions possibly representing fault traces widened through subsequent sediment failure. The source of the electrical noise is unknown. High backscatter is dark.

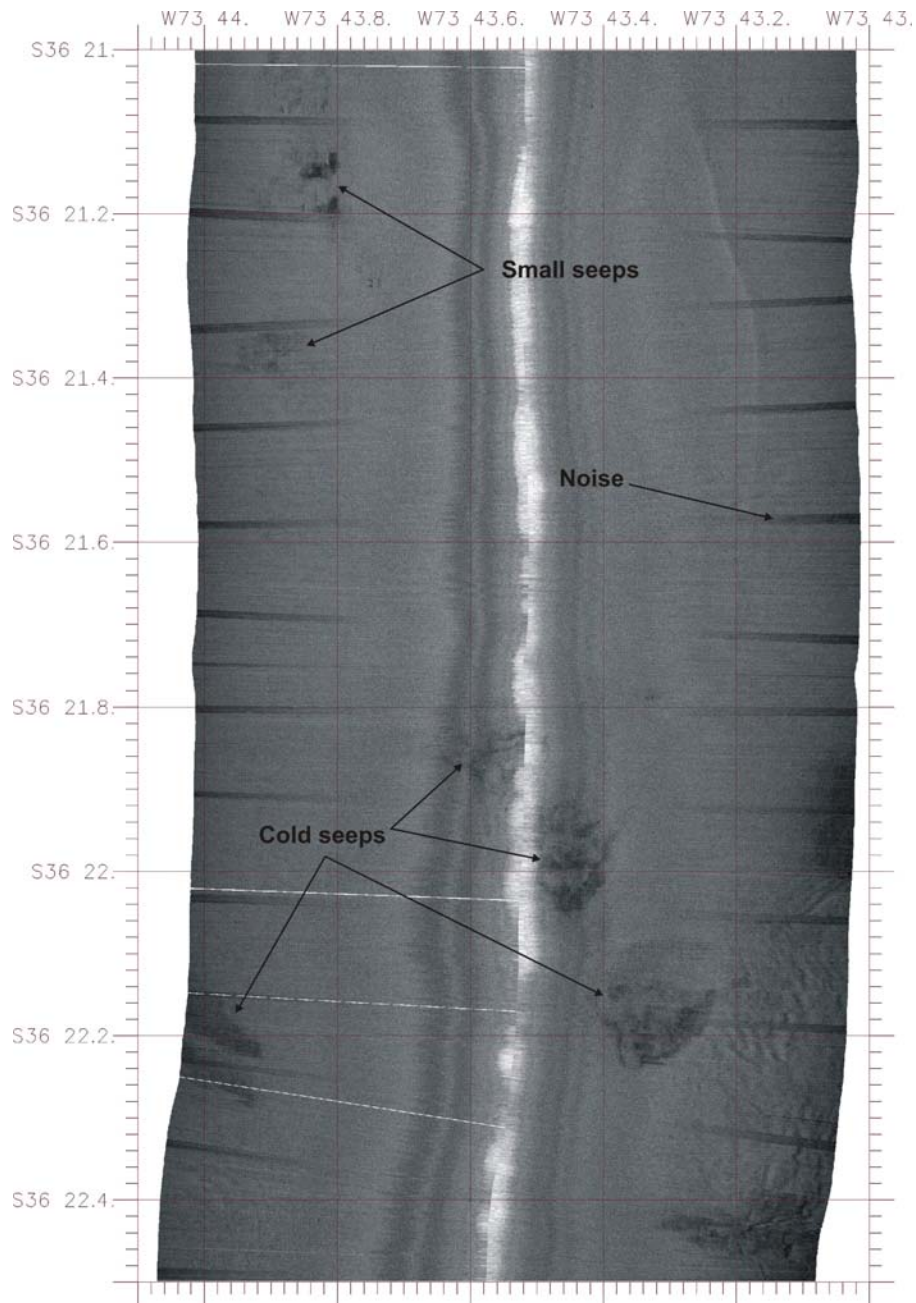

Figure 10.6: 75 kHz sidescan sonar profile showing high backscatter patches (dark areas) possibly representing cold seeps.

Valés slumo

Despite the partial availability of USBL data for this survey, preliminary processing of the sidescan sonar data has been carried out using ships navigation and cable length. The reliability of the USBL data will first have to be verified. The entire outline of the submarine slump has been imaged and several features of this submarine slope failure are visible on the Sidescan sonar mosaic. A vast area of the western margin of the intraslope basin shows elevated backscatter intensities and probably corresponds to the outline of the failure scar (Fig. 10.7). The elevated backscatter intensity could, however, also be due to the sole effect of inclined slope. This area is not uniform in its backscatter response, but shows bands of

slightly varying backscatter intensities along the axis of the submarine mass failure. These bands could indicate the main failure direction, but small blocks and breaks are also visible perpendicular to this direction. Downslope of the presumed failure area and in particular at the north-eastern end of it, clear indications of radiating flow structures are visible (Fig. 10.8) and would suggest that mass transport processes have been active recently, as they have not yet been buried by slope sedimentation.

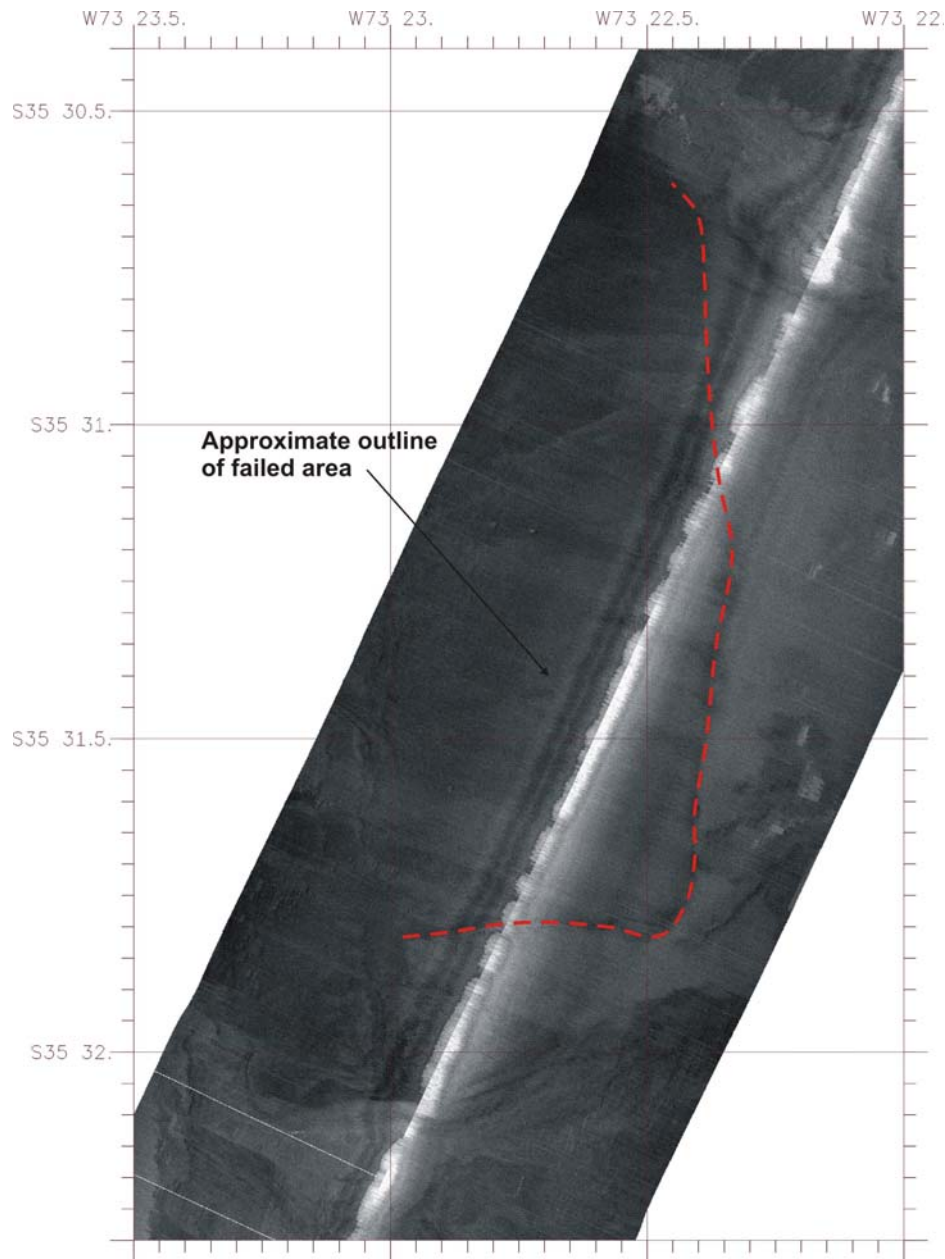

Figure 10.7: 75 kHz Sidescan sonar profile showing the transition from the (presumed) failure scar to the depositional area of the mass failure. The dashed line corresponds to a break in slope that is also visible in the bathymetry.

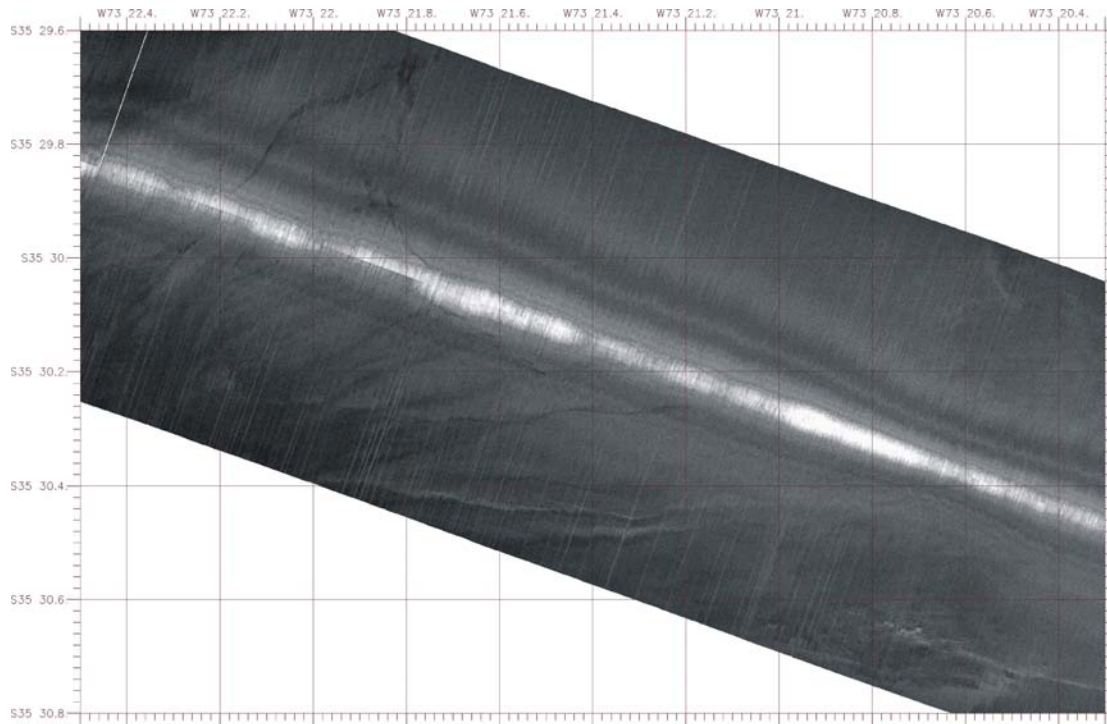

Figure 10.8: *75 kHz sidescan sonar profile showing a series of flow structures at the northern margin of the investigated submarine landslide. High backscatter is dark.*

The more distal portions of the mass failure show a variety of either clustered or individual block of varying size that probably mark the main depositional area of the slump (Fig. 10.9). The majority of these blocks form two distinct bands stretching north-south across the depositional area of the mass failure and could suggest at least two different failure events. These bands are approximately two kilometres apart and the area between them only show individual blocks of up to 200 metres in diameter (Fig. 10.9). This area also shows several highly irregular lineations corresponding to small (few metres of throw) steps in the bathymetry. Two of these steps that are roughly one kilometre apart are visible on figure 10.9. Downthrow of the steps is towards the south and the origin of the steps is not known but could be related to compactions of the failure deposit or maybe some secondary instability of the deposit due to ongoing deformation.

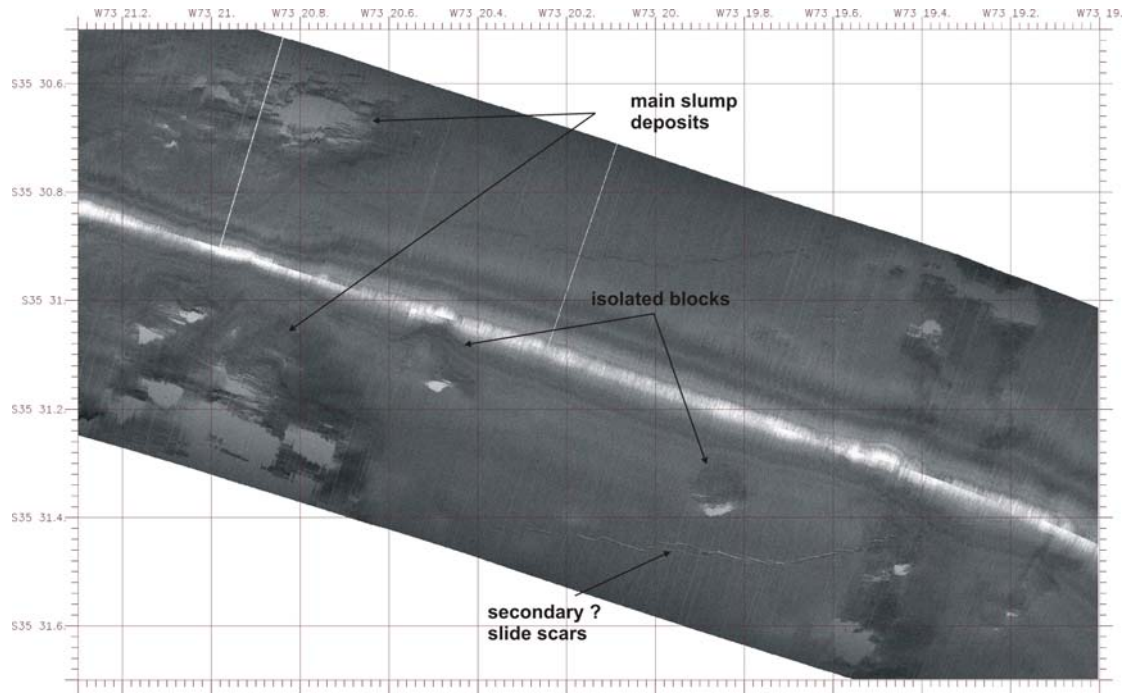

Figure 10.9: 75 kHz Sidescan sonar profile crossing the depositional area of the mass failure. High backscatter is dark.

Southern area

The sidescan sonar data of the third deployment show wide areas of uniform low backscatter intensity that probably correspond to “normal” background sedimentation in this intraslope basin. In contrast to this background sedimentation several areas showing varying degrees of increased backscatter intensity stand out. These areas quite likely correspond to active cold seeps, as acoustic anomalies in the water column (Fig. 10.10) point out. At least two types of cold seeps can be distinguished on first analysis. One type is characterised by a highly irregular surface with strong relief as indicated by the alternation of high backscatter intensities and shadows (Fig. 10.11). These areas are up to 500 metres across and are generally surrounded by areas of high backscatter intensity without relief (=absence of shadow zones) bringing the total extension of the cold seep to more than 1000 metres. The second type shows only intermediate backscatter intensity in a large number of relatively small (< 200 metres diameter) individual patches that show some clear clustering (Fig. 10.12). Much of the surveyed area also shows the presence of gas in the subsurface in form of a gas front lying generally in 5-15 metres depth below seafloor. This gas front reaches the seafloor in areas of high backscatter intensity.

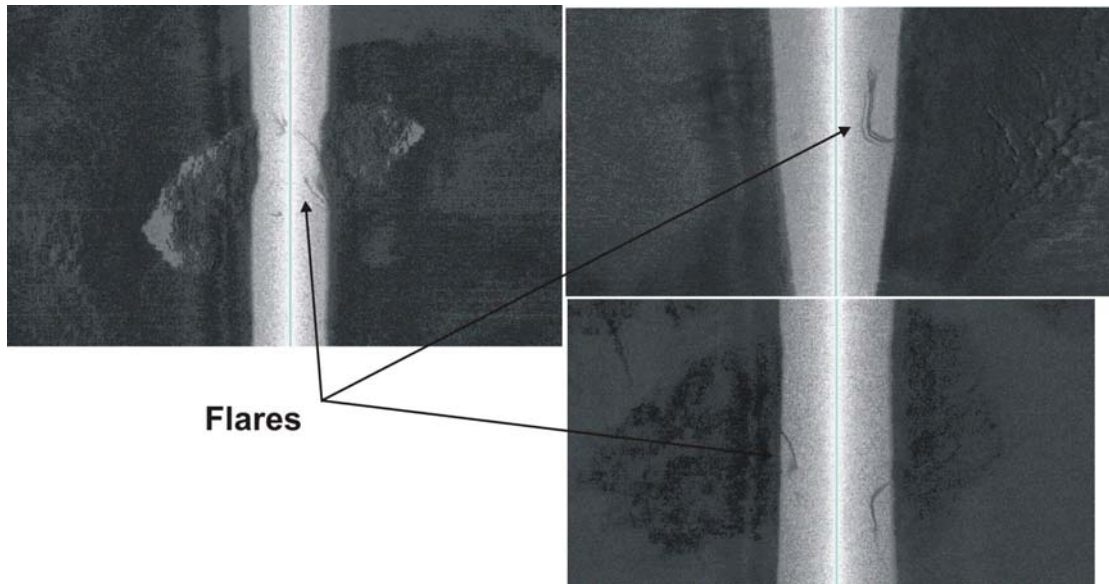

Figure 10.10: Raw sidescan sonar images showing the presence of acoustic anomalies in the water column. They most likely represent gas bubbles emanating from active cold seeps. High backscatter is dark.

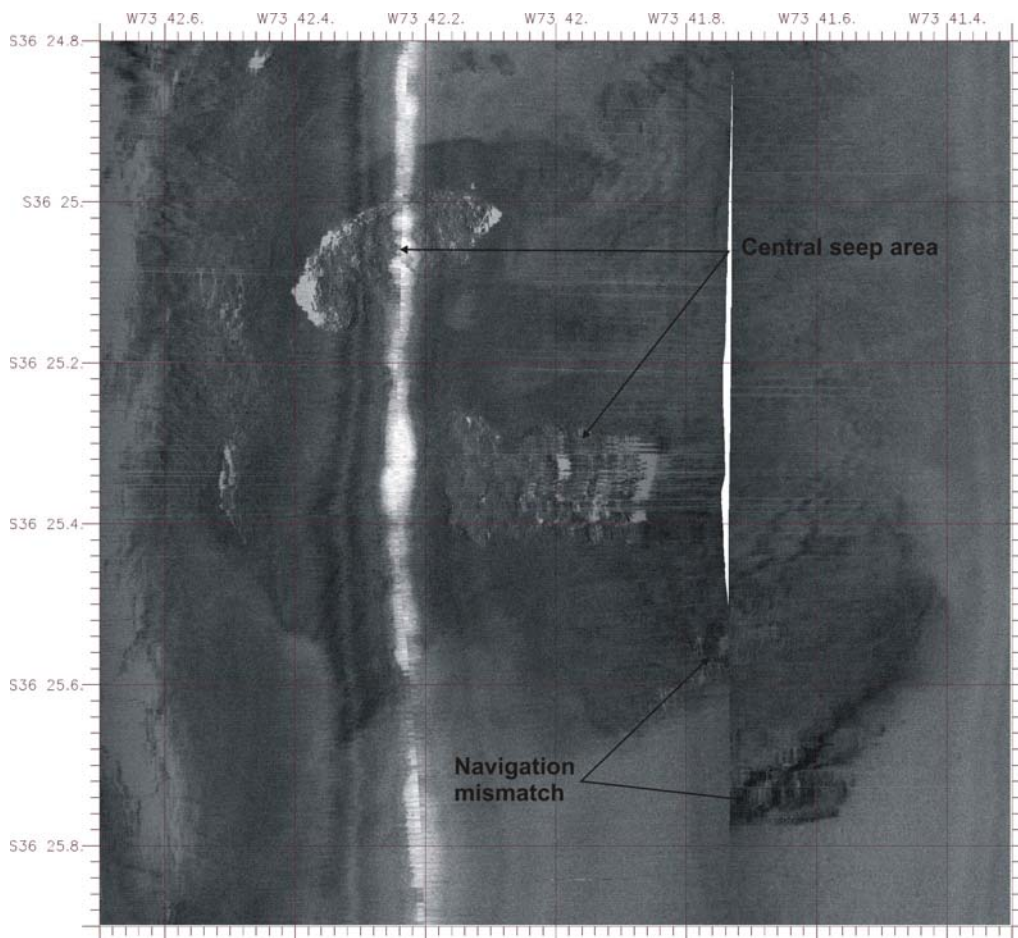

Figure 10.11: Mosaic of 75 kHz Sidescan sonar data show areas of major cold seep activity offshore Chile. The horizontal stripe between 25 and 25.4 minutes south are due to high winch speed. High backscatter intensity is dark.

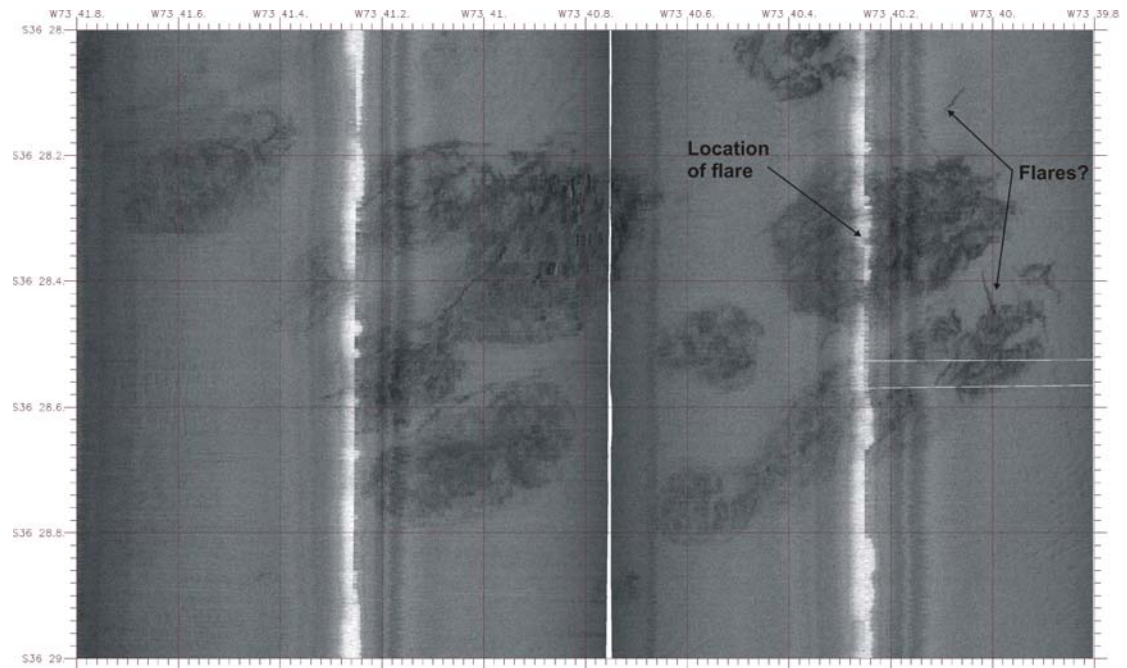

Figure 10.12: *Mosaic of 75 kHz Sidescan sonar data show clusters of high backscatter intensity that are interpreted as cold seeps.*

11. Coring

Gravity coring was performed using a NIOZ (Royal Netherlands Institute for Sea Research) gravity corer with a headweight of 1.5 t and a steel pipe, fitted to contain PVC-liners of 90 mm diameter. The pipe was composed of segments of 6 m, our standard length was 12 m. Liners were cut into ~ 1 m segments, sealed and stored at 5 degree C. These segments were not split during the cruise but will be further prepared and investigated at the IFM-GEOMAR. Altogether, 13 cores, GC01 to GC13, with a total length of 34,6 m were retrieved (Fig. 8.2.2.11).

Coring was carried out within three target areas. The first target was a submarine landslide of the lowermost continental slope at 35°35'S. This landslide produced an arcuate, steep scarp of almost 2000 m height, an olistolith composed of several detached blocks of 300 m height and a 15 km long debris cone. The headscarp consists of a steep (20-30°) sliding plane, the olistolith and debris cone cover about 100 km of the seafloor in the sediment-filled Peru-Chile Trench. The coring plan was laid out to sample an undisturbed reference core upslope of the headscarp, several samples from the headscarp in order to get material from the sliding plane, the top of the most prominent detached block and the distalmost parts of the landslide. The two coring points from the distal part of the landslide were chosen on basis of subbottom profiler data which showed a well-layered top part (post-slump sediments) resting on an acoustically transparent, wedge-shaped sediment body (debrite, slumped material). The goal was to sample both acoustic units which may provide material appropriate for dating the event. The reference core (GC01) was retrieved successfully (6,7 m core length), whereas the headscarp with the sliding plane resisted penetration. The core catcher was filled by about 20 cm of extremely stiff, almost dry clay (GC02, GC03 & GC13). On GC03, the material had to be removed from the cutter with hammer and chisel. Obviously, the combination of steep slope (20-25°) and very compacted material made it impossible to sink the corer in. The distal toe was successfully sampled at GC11 (5,16 m).

The second target was a mass wasting structure on the middle slope at 35°32'S, 73°23'W. This feature originated from the landward-vergent flank of a trench-parallel sediment ridge and ran eastwards into a slope basin. The layout of coring sites was similar to the one applied for target one. The intention was to get an undisturbed reference core on the flank of one of the sidewalls (GC07), a sample from the headscarp (GC08) and a sample from the distalmost part of the slump where both post-slump sediments and a thin debrite seemed to be present (GC09). By mischance, the first two attempts failed. The winch tension seemed to indicate that the corer hit hard ground and toppled over. In the case of GC08, the corer was severely bent, the core catcher material was composed of stiff, compacted clay. The core from the distalmost part (GC09) came up bent, but retrieved 1,5 m of sediment.

The third target was the hemipelagic sediment cover of the Nazca Plate. In order to investigate small-scale chemical processes like element mobilization (e.g. of iodine and bromine) in the sedimentary column, we retrieved three cores (GC04-GC06) from different locations, each within small basins of the horst and graben structure of the Nazca Plate, originating from the seafloor-spreading fabric (GC04-GC06). All three cores retrieved soft, water-rich and muddy sediments and penetrated 5-7 m. Judging from mud stains on the core and headweight of the corer, core GC04 went in deeper, but probably the speed of penetration was too high. As a consequence, the water inside the core could not escape fast enough through the valve at the top of the corer and built up a back pressure which would not allow for more sediment entry. Details on all cores are given in Appendix 15.6.

12. Methane sensors

The detector of the METS (Franatech) methane sensor is a semi-conductor. Adsorption of hydrocarbons on the active layer leads to electron exchange with oxygen and thus to modification of the conductivity of the active layer, which the electronic converts into a voltage. A membrane desorbs dissolved gasses of the surrounding water into the gas phase containing the detectors. The diffusion is driven by Henry's Law. The direction is conditioned to the



concentration gradient between water and gas phase, and within the membrane itself. The sensor is calibrated at relative humidity of 100%. Operational temperature range: -2°C to +60°C, calibration range 2 – 20°C; Methane: 50 nmol/l – 10 µmol/l Response: Reaction time: 1 to 3 sec. t90-time: 5 to 30 min dependent on turbulences. Typical range limits are concentrations between 50 nmol/l and 10 µmol/l, and temperatures between 2 and 20°C.

The methane data logger is different to those of the seismic recorders and can be mounted in one pressure tube together with the seismic data logger both of them sharing one power source. The methane sensors are then mounted on OBS instruments together with the seismic sensors.

Methane Data

The configuration of the data logger and the download management is run under Windows-based software. For data storage, a 512 MB Secure Digital Card (SD-Card) is used. The logging interval is the time between two records of data on the SD-card. It can be set between 1 and 90 min, and between 1 and 24 hours. The acquisition time is the time within the logging interval during which measurement values are acquired and averaged.

Each sensor is calibrated under reference condition (25°C, 1 bar, 0 ‰ salinity) for a sensor-specific conversion formula. The output conversion formula describes the relation between the sensor signal output-voltage (U1 and U2) and the concentration of dissolved methane. U1 and U2, methane, and temperature voltage, are converted to the methane concentration C (in µmol/l) and gas temperature T (in °C). The conversion formula for each sensor is given in Figure 12.1. Over time the sensors drift and the specific calibration formulae are not applicable anymore. However with different calibration formulae not the absolute methane concentration can be obtained but still variations in the methane concentration, which we are interested in. Most stations provided reasonable data, which are displayed in Figures 12.2 - 12.5.

FormulaSerial number: **T27**

$$c = \exp \left[1,949 * \ln \left\{ \left(0,380 + 1,149 * \exp \frac{-U_t}{0,706} \right) * \left(\frac{1}{U_{CH_4}} - \frac{1}{0,554 + 8,102 * \exp \frac{-U_t}{0,538}} \right) \right\} \right]$$

$$t = (21,573 * U_t) - 3,221$$

Serial number: **T28**

$$c = \exp \left[2,037 * \ln \left\{ \left(0,239 + 0,910 * \exp \frac{-U_t}{1,139} \right) * \left(\frac{1}{U_{CH_4}} - \frac{1}{0,920 + 10,802 * \exp \frac{-U_t}{0,451}} \right) \right\} \right]$$

$$t = (21,128 * U_t) - 1,438$$

Serial number: **T29**

$$c = \exp \left[2,028 * \ln \left\{ \left(-0,131 + 1,226 * \exp \frac{-U_t}{2,047} \right) * \left(\frac{1}{U_{CH_4}} - \frac{1}{1,072 + 9,930 * \exp \frac{-U_t}{0,383}} \right) \right\} \right]$$

$$t = (21,537 * U_t) - 0,560$$

Serial number: **T30**

$$c = \exp \left[1,965 * \ln \left\{ \left(-0,105 + 1,289 * \exp \frac{-U_t}{2,032} \right) * \left(\frac{1}{U_{CH_4}} - \frac{1}{0,529 + 8,860 * \exp \frac{-U_t}{0,466}} \right) \right\} \right]$$

$$t = (21,375 * U_t) - 4,874$$

c = methane concentration [$\mu\text{mol/l}$]t = gas temperature [$^{\circ}\text{C}$] U_{CH_4} = methane voltage [V] U_t = temperature voltage [V]Reference conditions for the methane concentration : 25 $^{\circ}\text{C}$, 1bar and 0 ‰ salinity**Figure 12.1.:** conversion formula for each sensor

Results

Along seismic profile 1, four methane sensors were deployed together with seismic stations in a depth of approx. 2000 m. The locations of the instruments are shown in Figure 6.3.1.1. Data were obtained by all four methane sensors, as shown in Figure 12.2.

In a similar way, for profiles P02 and P03 4 instruments were operated with a methane sensor (see data in Figures 12.3 and 12.4). Some artefacts are quite apparent in the data.. deployment and recovery times are also indicated in the figures. Apparently, the sensors need some time to adapt to the seafloor conditions before any reliable data are obtained.

For profile P08 three instruments were deployed, with one instrument (OBM802) being equipped with two sensors/data loggers. The sensors were separated by 50 cm only. For the first two days, the measured voltages resemble one another quite well. Despite this, the calculated methane concentrations are rather dissimilar. It is obvious, that the calibration formulas used may not be correct for the pressure/temperature conditions met. This requires further and future investigations.

Details on instrumentation are given in Appendix 15.1.

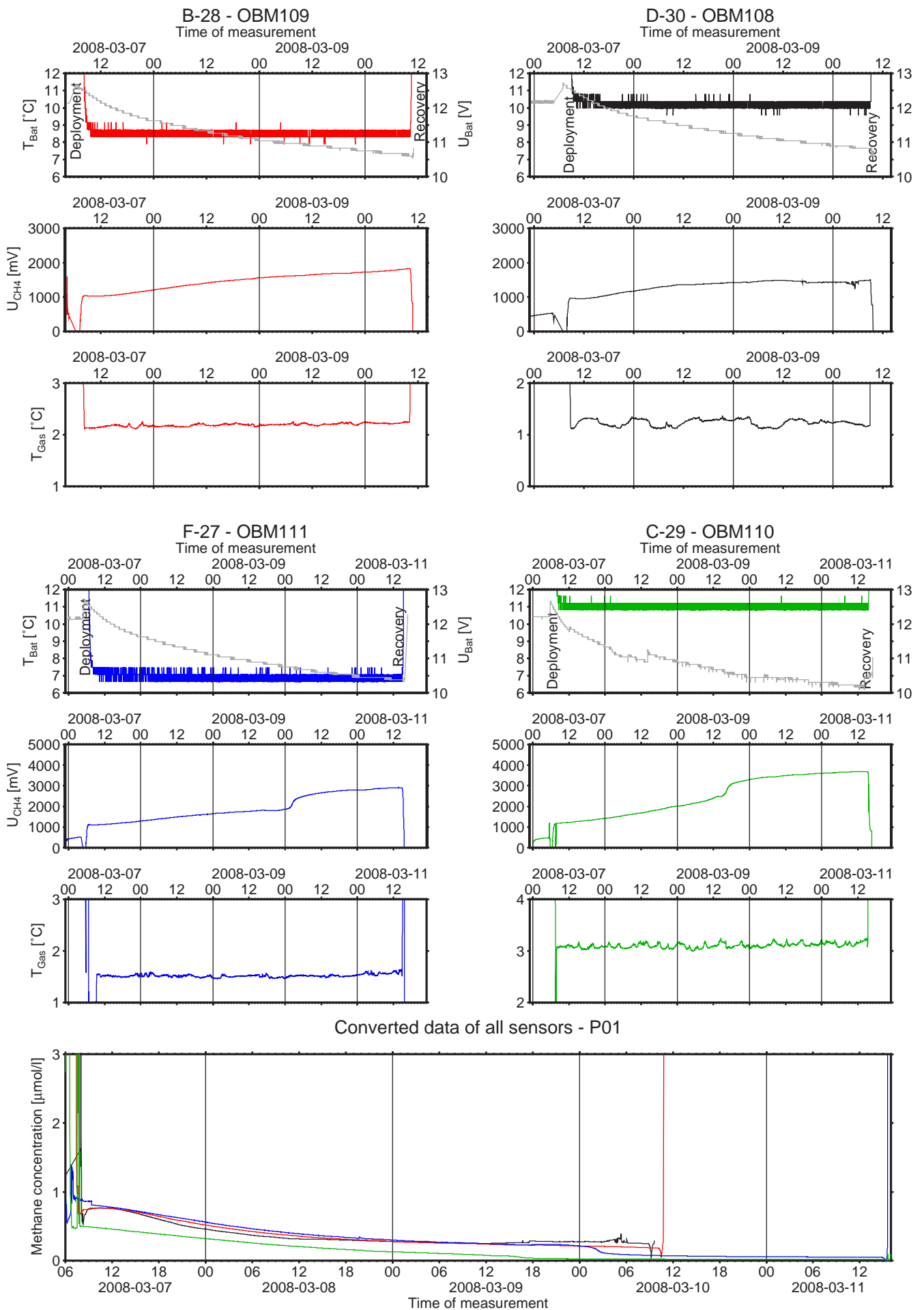

Fig. 12.2: Upper four diagrams-sections display temperature (T_{Bat} in color) and voltage (U_{Bat} in grey) of the batteries, methane voltage (U_{CH_4}), and gas temperature (T_{Gas}), respectively for each sensor. Lower diagram shows the methane concentration for all four sensors.

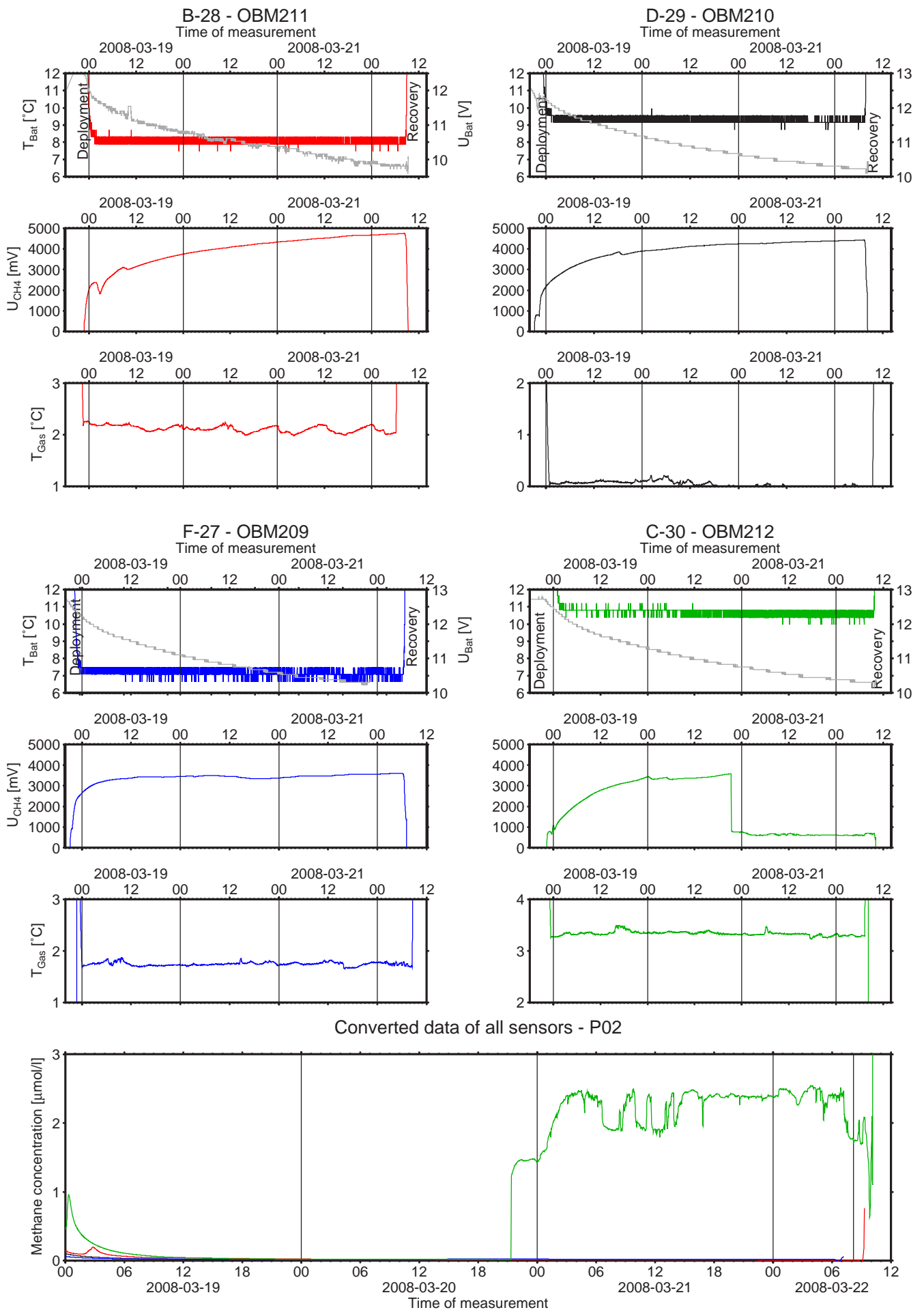

Fig. 12.3: Upper four diagrams-sections display temperature (T_{Bat} in color) and voltage (U_{Bat} in grey) of the batteries, methane voltage (U_{CH_4}), and gas temperature (T_{Gas}), respectively for each sensor. Lower diagram shows the methane concentration for all four sensors.

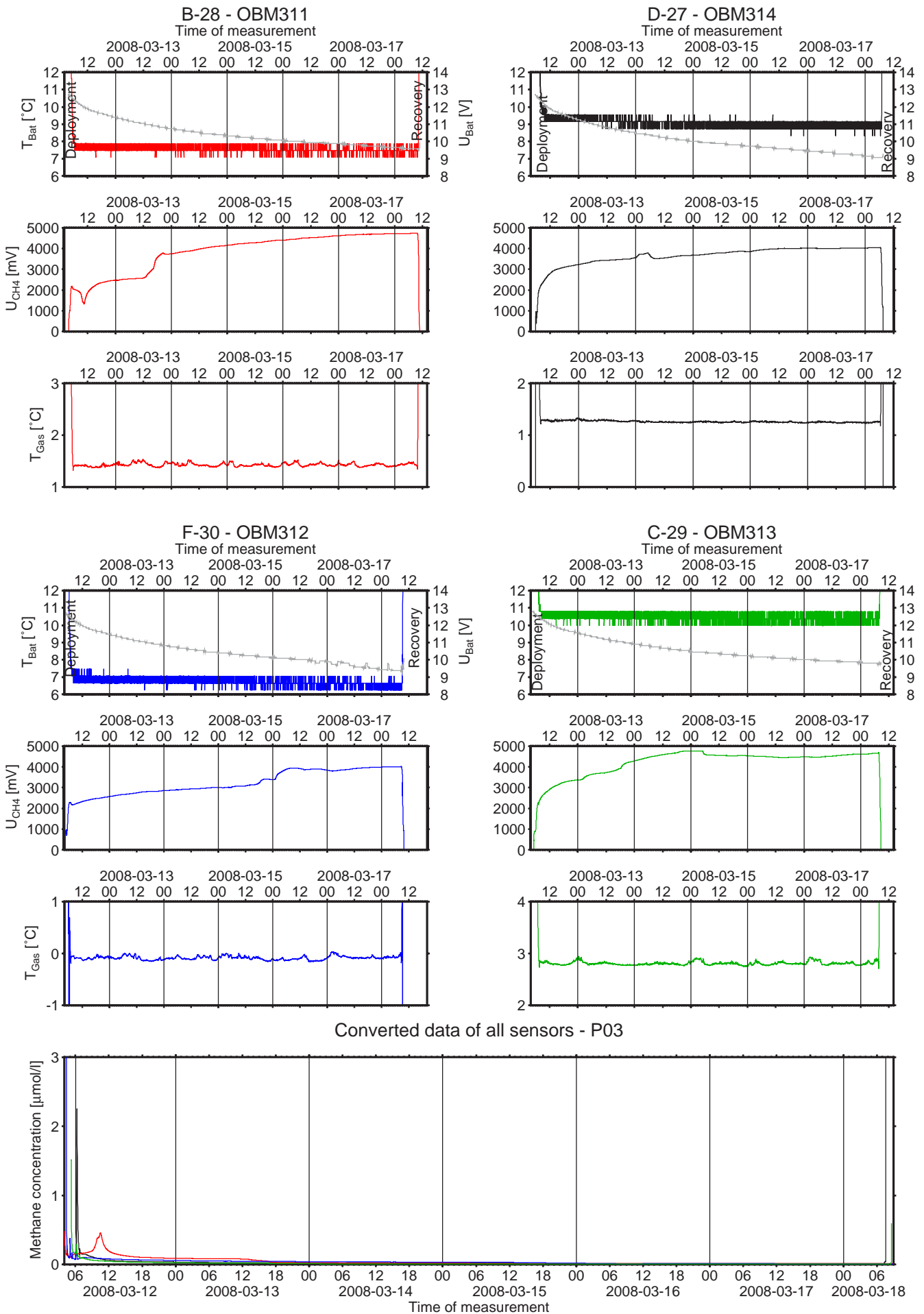

Fig. 12.4: Upper four diagrams-sections display temperature (T_{Bat} in color) and voltage (U_{Bat} in grey) of the batteries, methane voltage (U_{CH_4}), and gas temperature (T_{Gas}), respectively for each sensor. Lower diagram shows the methane concentration for all four sensors.

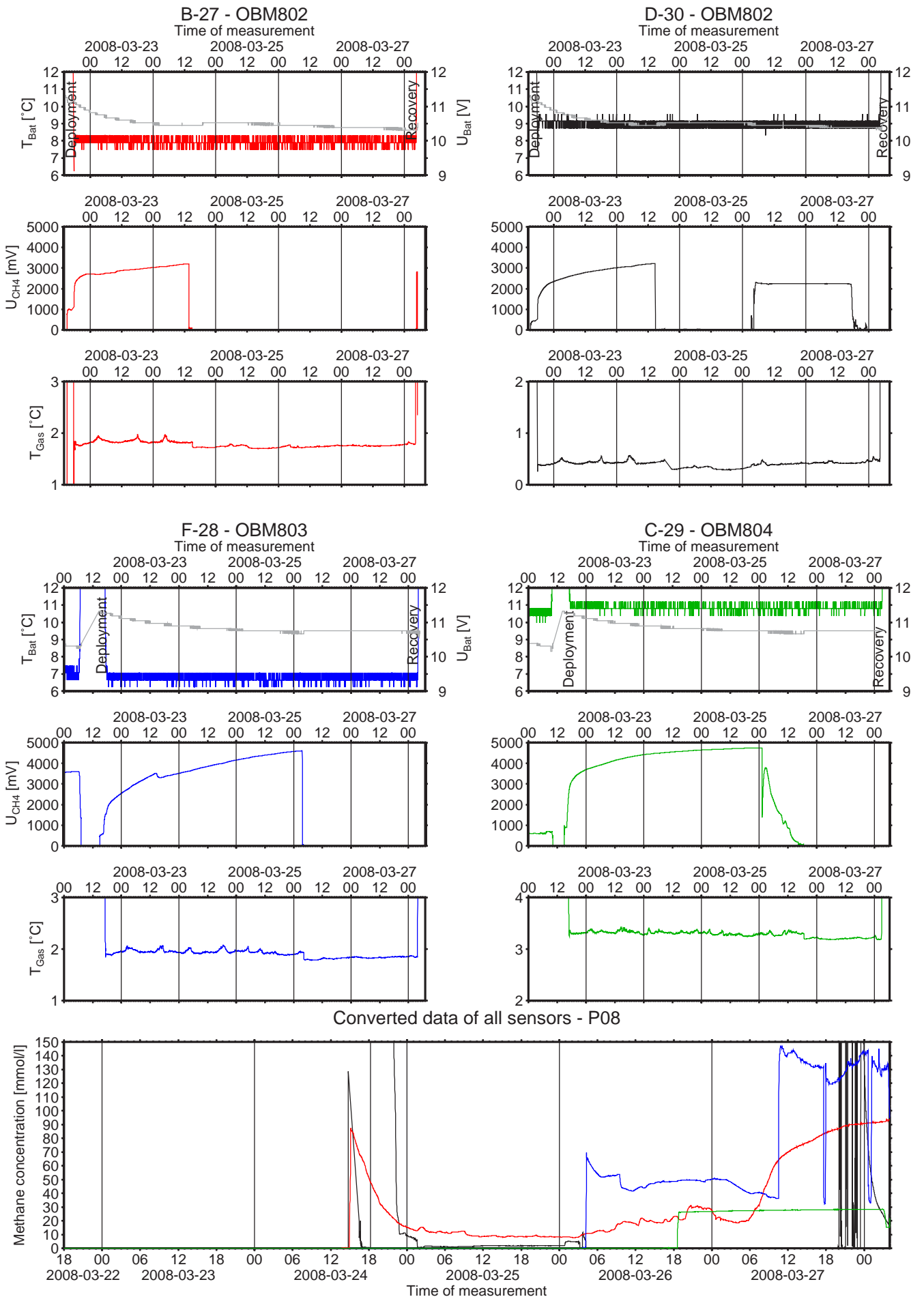

Fig. 12.5: Upper four diagrams-sections display temperature (T_{Bat} in color) and voltage (U_{Bat} in grey) of the batteries, methane voltage (U_{CH4}), and gas temperature (T_{Gas}), respectively for each sensor. Lower diagram shows the methane concentration for all four sensors.

13. Acknowledgement

Cruises JC23-A and JC23-B were the first large scale expeditions carried out under the OFEG Barter agreement. With all German full ocean capable research vessels operating far away from the Chilean coast support by the British RRS JAMES COOK was most welcome. During several preparatory meetings in Germany and Britain IFM-GEOMAR received a superior support for preparation of this cruise through the NERC NMF team. Providing and servicing seismic sources and additional geophysical equipment throughout both legs formed the reliable base for an outstanding survey. Financial support was granted by DFG through funding of the SFB574 at the University of Kiel. Special thanks are dedicated to Captain Peter Sarjeant and the entire crew of RRS JAMES COOK. Without their professional support under all circumstances this cruise would not have had such a great success.

14. References

- Carlson, R. L. and D. J. Miller (2004). Influence of pressure and mineralogy on seismic velocities in oceanic gabbros; implications for the composition and state of the lower oceanic crust. *Journal of Geophysical Research* 109(B9): 17.
- Chapple WM, Forsyth, DW (1979) Earthquakes and bending plates at trenches. *J. Geophys. Res.*, 84: 6729-6749
- Grevemeyer, I., Kaul, N., Diaz-Naveas, J.L., Villinger, H., Ranero, C.R. & Reichert, C., 2005. Heat flow and bending-related faulting at subduction trenches: case studies offshore of Nicaragua and Central Chile, *Earth planet. Sci. Lett.*, 236, 238–248.
- Grevemeyer, I., Ranero, C., Flueh, E.R., Klaeschen, D., Bialas, J. (2007). Passive and active seismological study of bending-related faulting and mantle serpentinization at the Middle America trench
EPSL, 258, 528-542, DOI: 10.1016/j.epsl.2007.04.013
- Hensen C., Wallmann K., M S., Ranero C. R., and Suess E. (2004) Fluid expulsion related to mud extrusion off Costa Rica - a window to the subducting slab. *Geology* 32(3), 201-204.
- Hyndman, R.D. & Wang, K., 1993. Thermal constraints on the zone of major thrust earthquake failure: the Cascadia subduction zone, *J. geophys. Res.*, 98, 2039–2060.
- Hyndman, R. D. and S. M. Peacock (2003). Serpentinization of the forearc mantle. *Earth and Planetary Science Letters* 212(3): 417-432
- Ivandic M, Grevemeyer I, Flueh ER, Berhorst A, McIntosh K (2008) Impact of bending-related faulting on the seismic properties of the incoming oceanic plate offshore of Nicaragua, *J. Geophys. Res.*, in press
- Kirby, S.H., Engdahl, E.R. & Denlinger, R., 1996. Intraslab earthquakes and arc volcanism: dual physical expressions of crustal and uppermost mantle metamorphism in subducting slabs, in *Subduction: Top to Bottom*, Vol. 96, pp. 195–214, eds Bebout, G.E. et al. Geophysical Monograph, Washington D.C., American Geophysical Union.
- the outer slope of the Japan Trench, *J. Phys. Earth*, 35, 381–407.
- Lefeldt, M. & I. Grevemeyer (2008), Centroid depth and mechanism of trench-outer rise earthquakes off Central America, *Geophys. J. Int.*, 172, 240-251, doi:10.1111/j.1365-246X.2007.03616.x
- Luff, R., K. Wallmann, et al. (2004). Numerical modeling of carbonate crust formation at cold vent sites; significance for fluid and methane budgets and chemosynthetic biological communities. *Earth and Planetary Science Letters* 221(1-4): 337-353
- Meade, C. & Jeanloz, R. (1991). Deep focused earthquakes and recycling of water into the Earth's mantle, *Science*, 252, 68–72.
- Mix, A. C., R. Tiedemann, et al. (2003). Initial Reports, ODP-leg 202. Proc. ODP, Init. Repts., 202 [Online].
- Petersen, C., I. Klaucke and W. Weinrebe (2006). Relationship Between Subduction Erosion, Seamount Subduction, Fluid Venting and Mound Formation on the Slope of the Costa Rican Continental Margin. Poster presentation at the Fall meeting of the AGU, Dec. 2006

- Ranero CR, Phipps Morgan J, McIntosh K, Reichert C (2003) Bending, faulting, and mantle serpentinization at the Middle America Trench. *Nature* 425: 367-373
- Ranero, C.R., Villaseor, A., Phipps Morgan, J. & Weinrebe, W., 2005. Relationship between bendfaulting at trenches and intraslab seismicity, *Geosys., Geophys., Geochem.*, 6, doi:10.1029/2005GC000997.
- Rawlinson N, de Kool M, Sambridge M (2006) Seismic wavefront tracking in 3-D heterogeneous media: applications with multiple data classes. *Explor Geophys* 37: 322-330
- Rawlinson N, Urvoy M (2006) Simultaneous inversion of active and passive source datasets for 3-D seismic structure with application to Tasmania. *Geophys Res Lett* 33: L24313, doi:10.1029/2006GL028105
- Romero, O. and C. Hensen (2002). Oceanographic control of biogenic opal and diatoms in surface sediments of the southwestern Atlantic. *Marine Geology* 186(3-4): 263-280.
- Rüpke, L., Phipps Morgan, J., Hort, M. & Connolly, J.D.A. (2002). Are the regional variations in Central America arc lavas due to differing basaltic peridotitic slab sources of fluids? *Geology*, 30, 1035–1038.
- Sellanes, J., E. Quiroga, and V. A. Gallardo (2004) First direct evidences of methane seepage and associated chemosynthetic communities in the bathyal zone of Chile: *Journal of the Marine Biological Association of the United Kingdom*, v. 84, p. 1065-1066.
- Sellanes, J., and E. Krylova (2005) A new species of Calyptogena (Bivalvia: Vesicomidae) from a recently discovered methane seepage area of Concepcion Bay, Chile (~36°S): *Journal of the Marine Biological Association of the United Kingdom*, v. 85, p. 969-976.
- Talukder, A.R., Bialas, J., Klaeschen, D., Buerk, D., Brueckmann, W., Reston, T., Breitzke, M. (2007) High-resolution, deep tow, multichannel seismic and sidescan sonar survey of the submarine mounds and associated BSR off Nicaragua pacific margin, *Marine Geology* (2007), doi: 10.1016/j.margeo.2007.03.002
- Tilman F, Grevemeyer I, Flueh ER, Dahm T, Gossler J (2008) Seismicity in the outer rise offshore southern Chile: indication of fluid effects in crust and mantle. *Earth Planet Sci Lett*, submitted
- Vinnik LP (1977), Detection of waves converted from P to SV in the mantle. *Phys Earth Planet Inter* 15: 294– 303
- Völker, D. And W. Weinrebe (2006). Submarine Landslides on the Continental Rise of Central and Southern Chile (32°S-45°S): Quantitative Description and Relation to the Segmentation of the Margin. Poster presentation at the Fall meeting of the AGU, Dec. 2006
- Weinrebe, W. and H.-W. Schenk (2006) Cruise Report M67-1 METEOR Reports (in press)
- Zhu L, Kanamori H (2000) Moho depth variation in southern California from teleseismic receiver functions. *J Geophys Res* 105: 2969– 2980

APPENDICES

15. APPENDICES	
15.1. Ocean Bottom Instrumentation	165
15.2. Airgunshots	172
15.2.1. Airgunshots P01	172
15.2.2. Airgunshots P02	174
15.2.3. Airgunshots P03	175
15.2.4. Airgunshots P04	176
15.2.5. Airgunshots P08-P09	177
15.2.6. Airgunshots P10	178
15.2.7. Airgunshots P11-P12-P13	179
15.3. Gravity	180
15.4. Scripts for processing of multibeam data	186
15.5. Magnetotelluric Instrumentation	199
15.6. Core descriptions	200
15.6.1. Core positions	200
15.6.2. Core protocol	201
15.7. Marine Mammal Report JC23	206
15.8. Timetable	207

Appendix 15.1. Ocean Bottom Instrumentation

INST.	LAT (N) D:M	LONG (E) D:M	DISTANCE TO NEXT	DEPLOY. DATE	RECOV. DATE	DEPTH (m)	RELEASE CODE TIME RELEASE	REC. NO.	SKEW (ms)	SENSORS
OBH102	35°19'03.8" S	72°32'40.51" W	3.5 nm	07.03.08	10.03.08	103	9256 (10.04.08 01:00)	MBS 980912	-	HTI 169
OBS103	35°17'33.24" S	72°41'20.67" W	3.5 nm	07.03.08	10.03.08	155	431501 (21.03.08 08:30)	MBS 020504	+ 13	HTI 88 + Owen 60
OBS104	35°16'04.25" S	72°45'09.16" W	3.5 nm	07.03.08	10.03.08	360	427623 (21.03.08 14:00)	MBS 000614	-22	HTI 64 + Owen 27
OBS105	35°14'31.64" S	72°49'01.82" W	3.5 nm	07.03.08	10.03.08	649	134037 (21.03.08 12:00)	MBS 001001	-24	HTI 79 + Owen 81
OBS106	35°13'00.3" S	72°53'04.9" W	3.5 nm	07.03.08	10.03.08	938	131351 (21.03.08 10:30)	MBS 020500	+ 06	HTI 48 + Owen 59
OBS107	35°32'73" S	72°56'51.3" W	3.5 nm	07.03.08	10.03.08	1130	435656 (21.03.08 13:30)	MBS 000611	-28	HTI 33 + Owen 24
OBS108	35°10'05.0" S	73°00'35.76" W	3.5 nm	07.03.08	10.03.08	1225	435703 (21.03.08 12:30)	MBS 010708	- 12	HTI 85+ Methan D / T30
OBS109	35°08'6.09" S	73°04'33.7" W	3.5 nm	07.03.08	10.03.08	1683	430067 (21.03.08 10:00)	MBS 020503	+ 14	HTI 91 + Methan B / T28
OBS110	35°07'07.4" S	73°08'09.2" W	3.5 nm	07.03.08	11.03.08	2137	430326 (21.03.08 11:30)	MBS 990712	- 13	HTI 68 + Methan C / T29
OBS111	35°05'40.21" S	73°12'00" W	3.5 nm	07.03.08	11.03.08	2130	134071 (21.03.08 06:30)	MBS 001003	+ 13	HTI 78 + Methan F / T27
OBS112	35°04'13" S	73°15'42" W	3.5 nm	07.03.08	10.03.08	1980	435610 (21.03.08 07:00)	MBS 000616	- 74	HTI 49 + Owen 41
OBS113	34°02'38.79" S	73°19'35.47" W	3.5 nm	07.03.08	10.03.08	2125	427524 (21.03.08 08:00)	MBS 980903	+ 08	HTI 73 + Owen 17
OBS114	35°01'07.68" S	73°23'24.18" W	3.5 nm	07.03.08	10.03.08	2990	250177 (21.03.08 19:30)	MBS 020505	+ 04	HTI 60 + Owen 75
OBS115	34°59'35.40" S	73°27'22.72" W	3.5 nm	07.03.08	10.03.08	4022	133770 (21.03.08 09:00)	MBS 020508	-02	HTI 58 + Owen 10
OBS116	34°57'58.20" S	73°31'20.52" W	3.5 nm	07.03.08	10.03.08	4752	427430 (21.03.08 15:00)	MBS 020506	defekt	HTI 23
OBS117	34°56'31.51" S	73°35'12.84" W	3.5 nm	07.03.08	10.03.08	5099	533664 (01.03.09 12:00)	MCS 060725		Guralp 059 + HTI 312128
OBS118	34°55'00.15" S	73°39'03.18" W	3.5 nm	07.03.08	10.03.08	5086	534224 (21.03.08 20:00)	MES 030901	+ 37	HTI 56
OBS119	34°53'36.12" S	73°42'41.29" W	3.5 nm	07.03.08	10.03.08	5234	134123 (21.03.08 09:30)	MTS 070506	+ 07	HTI 50
OBS120	34°52'04.74" S	73°46'29.06" W	3.5 nm	07.03.08	10.03.08	5091	133525 (21.03.08 13:00)	MES 030904	+ 261	OAS 22
OBS 121	34°50'38.55" S	73°50'11.85" W	3.5 nm	06.03.08	05.04.08	5063	431075 (10.04.08 12:30)	MTS 041101	167	HTI 312160 + Owen 03
OBS122	34°49'08.15" S	73°54'04.50" W	3.5 nm	07.03.08	10.03.08	4773	435551 (21.03.08 19:30)	MES 031002	+ 419	OAS 04
OBS123	34°47'41.80" S	73°57'51.60" W	3.5 nm	08.03.08	10.03.08	4891	432367 (21.03.08 18:00)	MES 980905	+ 03	OAS 36
OBS 124	34°46'23" S	74°01'53" W	3.5 nm	08.03.08	05.04.08	4734	145147 (10.04.08 11:00)	MLS 991742	-17	HTI 77 + Owen 55
OBS125	34°44'40.08" S	74°05'30.06" W	3.5 nm	08.03.08	10.03.08	4106	133664 (21.03.08 18:30)	MES 031001	+ 162	OAS HH + Owen 14
OBS126	34°43'09.20" S	74°09'19.80" W	3.5 nm	08.03.08	10.03.08	4186	133477 (21.03.08 11:00)	MBS 010703	- 16	HTI AWI + Owen 03
OBS 127	34°41'35.34" S	74°13'16.66" W	3.5 nm	06.03.08	05.04.08	4155	430274 (10.04.08 08:30)	MLS 010408	-31	HTI 53 + Owen 5
OBS 128	34°40'03.00" S	74°17'05.35" W	3.5 nm	08.03.08	10.03.08	4050	131415 (21.03.08 06:00)	MBS 991292	-08	Owen 29
OBS130	34°37'46.23" S	74°22'52.04" W	3.5 nm	08.03.08	11.03.08	4226	533770 (21.03.08 15:30)	MBS 020507	+ 51	Owen 33
OBS 131	34°35'49.479" S	74°28'62886" W		06.03.08	04.04.08	4212	430424 (10.04.08 / 08:00)	MLS 991243	53	HTI 31200902 + Owen 28

JC 23 - Profile 01

Appendix 15.1. Ocean Bottom Instrumentation

INST.	LAT (N) D:M	LONG (E) D:M	DISTANCE TO NEXT	DEPLOY. DATE	RECOV. DATE	DEPTH (m)	RELEASE CODE TIME RELEASE	REC. NO.	SKEW (ms)	SENSORS
OBH202	35°08'07.77" S	72°28'01.57" W	3.5 nm	18.03.08	20.03.08	131	9256 (10/04/08,01:00)	MTS 070506	+3	HTI 69
OBS203	35°08'50.50" S	72°31'58.90" W	3.5 nm	18.03.08	20.03.08	150	134037 (04/04/08, 02:00)	MBS 020511	+7	HTI 04 + Owen 60
OBS204	35°05'30.70" S	72°35'54.79" W	3.5 nm	18.03.08	21.03.08	179	430067 (04/04/08, 01:00)	MBS 020505	+4	OAS HH + Owen 14
OBS205	35°04'14.15" S	72°39'50.89" W	3.5 nm	18.03.08	21.03.08	399	133664 (04/04/08, 03:00)	MBS 001001	-17	HTI 79 + Owen 81
OBS206	35°02'57.22" S	72°43'48.91" W	3.5 nm	18.03.08	21.03.08	601	131351 (04/04/08, 04:00)	MBS 990905	+2	HTI 48 + Owen 59
OBS207	35°01'40.30" S	72°47'45.50" W	3.5 nm	18.03.08	21.03.08	850	250177 (04/04/08, 05:00)	MBS 020508	-379	HTI 60 + Owen 24
OBS208	35°00'18.73" S	72°51'40.21" W	3.5 nm	18.03.08	21.03.08	941	134071 (04/04/08, 06:00)	MBS 020504	+15	HTI 49 + Owen 41
OBH/M209	34°59'03.13" S	72°55'42.65" W	3.5 nm	18.03.08	22.03.08	1666	435610 (04/04/08, 07:00)	MBS 001003	+13	HTI 78 + Methan F050928/T27
OBH/M210	34°57'44.50" S	72°59'40.08" W	3.5 nm	18.03.08	22.03.08	1860	427430 (04/04/08, 08:00)	MBS 020503	+18	HTI 8 + Methan D050928/T29
OBH/M211	34°56'27.26" S	73°09'33.83" W	3.5 nm	18.03.08	22.03.08	2120	435704 (04/04/08, 09:00)	MBS 010708	-13	HTI 91 + Methan E050928/T28
OBH/M212	34°55'10.83" S	73°07'38.18" W	3.5 nm	18.03.08	22.03.08	2379	430173 (no TR)	MBS 991292	-8	HTI 85 + Methan C050928/T30
OBH213	34°53'51.09" S	73°11'32.26" W	3.5 nm	19.03.08	21.03.08	2415	533770 (04/04/08, 09:30)	MES 031001	+126	HTI 33
OBS214	34°52'32.18" S	73°15'32.20" W	3.5 nm	19.03.08	21.03.08	2825	427524 (04/04/08, 10:00)	MBS 980903	no data	HTI 73 + Owen 17
OBS215	34°51'12.23" S	73°19'29.79" W	3.5 nm	19.03.08	21.03.08	2936	134123 (04/04/08, 11:00)	MBS 020507	-140	Owen 27
OBS216	34°49'54.50" S	73°23'27.09" W	3.5 nm	19.03.08	21.03.08	3379	534224 (04/04/08, 11:30)	MBS 000614	-21	HTI 36+ Owen 24
OBS217	34°48'37.93" S	73°27'21.04" W	3.5 nm	19.03.08	21.03.08	3859	133770 (04/04/08, 13:00)	MES 030904	+384	HTI 58+Owen 10
OBS218	34°47'20.92" S	73°31'19.77" W	3.5 nm	19.03.08	21.03.08	4579	133525 (04/04/08, 10:30)	MBS 010703	-15	HTI 64 + Owen 3
OBS219	34°46'03.55" S	73°35'20.81" W	3.5 nm	19.03.08	21.03.08	5051	435551 (04.04.08, 12:00)	MES 031002	+491	HTI 50 + Owen 33
OBS220	34°44'44.66" S	73°39'09.45" W	3.5 nm	19.03.08	21.03.08	5091	427623 (04.04.08, 12:30)	MES 030903	+107	HTI 68 + Owen 22
OBS 221	34°43'39.285" S	73°43'16.315" W	10.5 nm	06.03.08	05.04.08	5043	143175 (10.04.08/15:30)	MBS 050809	136	HTI 72 + Owen 63
OBS 224	34°40'54.56" S	73°51'05.26" W	10.5 nm	06.03.08	05.04.08	5112	145331 (10.04.08 / 12:00)	MLS 000709	-99	HTI 71 + Owen 13
OBS 227	34°36'59.62" S	74°02'51.01" W	7.0 nm	06.03.08	05.04.08	4510	435517 (10.04.08 / 11:30)	MLS 000708	-268	HTI 94 + Owen 42
OBS 229	34°34'33903" S	74°10'83016" W		05.03.08	05.04.08	4026	143272 (01.04.08 / 09:30)	MLS 020601	115	HTI 80 + Owen 79

JC23 - Profile 02

Appendix 15.1. Ocean Bottom Instrumentation

INST.	LAT (N) D:M	LONG (E) D:M	DISTANCE TO NEXT	DEPLOY. DATE	RECOV. DATE	DEPTH (m)	RELEASER CODE TIME RELEASE	REC. NO.	SKEW (ms)	SENSORS
OBH302	34°50'21.12"	72°18'50.21"	3.5 nm	11.03.08	15.03.08	410	9256 (10.04.08, 01:00)	MBS 980904		HTI 69
OBH303	34°49'00.00"	72°22'44.58"	3.5 nm	11.03.08	15.03.08	348	430326 (21.03.08, 11:30)	MBS 020504	+ 15	HTI 68 + Owen 22
OBH304	34°47'42.63"	72°26'41.57"	3.5 nm	11.03.08	15.03.08	477	533770 (21.03.08, 15:30)	MBS 000614	- 27	HTI 88 + Owen 33
OBH305	34°46'20.26"	72°30'42.52"	3.5 nm	11.03.08	15.03.08	652	131415 (21.03.08, 06:00)	MBS 001001	- 27	OAS 36 + Owen 29
OBH306	34°44'59.11"	72°34'38.13"	3.5 nm	11.03.08	15.03.08	740	133477 (21.03.08, 11:00)	MBS 020500	+ 8	OAS 66 + Owen 03
OBH307	34°42'35.67"	72°38'42.73"	3.5 nm	12.03.08	15.03.08	809	133770 (21.03.08, 09:00)	MBS 000611	- 30	OAS 58 + Owen 10
OBH308	34°42'22.96"	72°42'21.27"	3.5 nm	12.03.08	15.03.08	866	250177 (21.03.08, 14:30)	MBS 000610	- 73	OAS 60 + Owen 75
OBH309	34°41'03.58"	72°46'20.05"	3.5 nm	12.03.08	15.03.08	1035	427524 (21.03.08, 08:00)	MBS 980903	+ 7	HTI 73 + Owen 17
OBH310	34°39'45.64"	72°50'12.44"	3.5 nm	12.03.08	15.03.08	2067	435610 (21.03.08, 07:00)	MBS 020505	+ 7	HTI 49 + Owen 41
OBH/M311	34°38'23.46"	72°54'13.54"	3.5 nm	12.03.08	18.03.08	2623	430067 (21.03.08, 10:00)	MBS 010708	- 23	HTI 91 + Methan B / T28
OBH/M312	34°37'00.92"	72°58'08.76"	3.5 nm	12.03.08	18.03.08	2556	435704 (21.03.08, 12:30)	MBS 001003	+ 19	HTI 85 + Methan F / T30
OBH/M313	34°35'47.59"	73°02'01.06"	3.5 nm	12.03.08	18.03.08	2794	427430 (21.03.08, 06:30)	MBS 991292	- 16	HTI 04 + Methan C / T29
OBH/M314	34°34'43"	73°05'98"	3.5 nm	12.03.08	18.03.08	2922	134071 (21.03.08, 06:30)	MBS 020503	+ 32	HTI 78 + Methan D / T27
OBH315	34°33'11"	73°09'88"	3.5 nm	12.03.08	15.03.08	3480	534224 (21.03.08, 20:00)	MES 030901	- 267	HTI 3120430
OBH316	34°31'7937"	73°13'7839"	3.5 nm	12.03.08	15.03.08	3770	134123 (21.03.08, 09:30)	MES 031002	+ 385	HTI 50
OBH317	34°30'28.33"	73°17'43.20"	3.5 nm	12.03.08	15.03.08	4255	133525 (21.03.08, 13:00)	MES 030904	+ 201	OAS 22
OBH318	34°29'11.84"	73°21'32.97"	3.5 nm	12.03.08	15.03.08	4903	430173 (no TR)	MTS 070506	+ 9	HTI 33
OBH319	34°27'5161"	73°25'29.86"	3.5 nm	12.03.08	15.03.08	5288	131351 (21.03.08, 10:30)	MBS 020508	- 5	HTI 48
OBH320	34°26'28.05" S	73°29'25.03" W	3.5 nm	05.03.08	10.04.08	5450	442102 (10.04.08 / 07:30)	MLS 040804	208	OAS 81 + Owen 36
OBH321	34°25'13.19"	73°33'22.80"	7.0 nm	12.03.08	15.03.08	4941	134037 (21.03.08, 12:00)	MBS 980905	+ 3	HTI 79
OBH323	34°22'30.25"	73°41'14.65"	3.5 nm	12.03.08	15.03.08	4673	431501 (21.03.08, 08:30)	MES 031001	+ 170	OAS 04 + Owen 60
OBH324	34°21'14.25" S	73°45'15.58" W	3.5 nm	05.03.08	10.04.08	4679	131245 (10.04.08 / 07:00)	MLS 991258	266	HTI 96 + Owen 39
OBH325	34°19'47.49" S	73°49'06.43" W	7.0 nm	04.03.08	06.04.08	4418	427737 (10.04.08 / 06:30)	MLS 040602	- 7	OAS 21 + Owen 15
OBH327	34°17'11.20"	73°57'00.26"	7.0 nm	12.03.08	17.03.08	4346	133664 (21.03.08, 18:30)	MBS 010703	- 151	Owen 14
OBH329	34°14'35.87" S	74°04'48.26" W	7.0 nm	04.03.08	10.04.08	4166	430135 (10.04.08 / 06:00)	MLS 991240	40	OAS 2 + Owen 34
OBH331	34°11'55.09"	74°12'39.39"	-	12.03.08	16.03.08	4030	427623 (21.03.08, 14:00)	MBS 020507	+ 67	Owen 27

JC23 - Profile 03

INST.	LAT (N) D:M	LONG (E) D:M	DISTANCE TO NEXT	DEPLOY. DATE	RECOV. DATE	DEPTH (m)	RELEASER CODE TIME RELEASE	REC. NO.	SKEW (ms)	SENSORS
OBH401	34°15'50.81"	74°00'59.30"	3.4 nm	15.03.08	17.03.08	4196	430173 (no TR)	MBS 070506	+ 5	HTI 33
OBH402	34°19'02.95"	74°02'32.96"	3.4 nm	15.03.08	17.03.08	3954	134037 (21.03.08, 12:00)	MBS 001001	- 16	HTI 79 + Owen 81
OBH403	34°22'16.29"	74°04'02.69"	3.4 nm	15.03.08	17.03.08	4276	431501 (21.03.08, 08:30)	MBS 020501	+ 5	OAS 04 + Owen 60
OBH404	34°25'24.94"	74°05'36.15"	3.5 nm	15.03.08	17.03.08	4201	131351 (21.03.08, 10:30)	MBS 020505	+ 4	HTI 48 + Owen 59
OBH405	34°28'41.44"	74°06'57.51"	3.4 nm	15.03.08	17.03.08	4020	435610 (21.03.08, 07:00)	MBS 980903	+ 4	HTI 49 + Owen 41
OBH406	34°31'54.45"	74°08'29.50"	5.5 nm	16.03.08	17.03.08	4145	250177 (21.03.08, 14:30)	MBS 980905	+ 1	HTI 60 + Owen 75
OBH407	34°36'57.00"	74°11'00.22"	2.7 nm	16.03.08	17.03.08	4160	427524 (21.03.08, 08:00)	MBS 020508	- 2	HTI 73 + Owen 17
OBH408	34°39'30.65"	74°12'10.00"	-	16.03.08	17.03.08	4150	435551 (21.03.08, 19:00)	MBS 020504	+ 10	OAS 36 + Owen 34

JC23 - Profile 04

Appendix 15.1. Ocean Bottom Instrumentation

INST.	LAT (N) D:M	LONG (E) D:M	DISTANCE TO NEXT	DEPLOY. DATE	RECOV. DATE	DEPTH (m)	RELEASE CODE TIME RELEASE	REC. NO.	SKEW (ms)	SENSORS
OBS 702	34°45'00.07" S	74°48'07.62" W		06.03.08	04.04.08	4070	430232 (10.04.08 / 15:00)	MLS 991234	70	HTI 26 + Owen 16
OBS 131	34°35.49479" S	74°28.62686" W		06.03.08	04.04.08	4212	430424 (10.04.08 / 08:00)	MLS 991243	53	HTI 31200902 + Owen 28
OBS 501	34°29'59.98" S	72°44'56.34" W		04.03.08		4603	444573 (01.03.09 / 02:30)	MCS 060745		Guralp 042 + HTI 312116
OBS 502	34°24'58.22" S	73°04'58.92" W		04.03.08		3397	430021 (01.03.09 / 00:00)	MCS 050902		Guralp 046 + HTI 312132
OBS 503	34°11'589" S	73°19'564" W		04.03.08	06.04.08	5330	3624 (10.04.08 / 0:00)	MLS 040806	-29	HTI 302 + Owen 53
OBS 504	33°56'55.88" S	74°04'56.88" W		04.03.08	06.04.08	3722	03B7 + 0355 (10.04.08 / 05:00)	MLS 040807	no skew	HTI 025 + Owen 38
OBS 329	34°14'35.87" S	74°04'48.26" W		04.03.08	10.04.08	4166	430135 (10.04.08 / 06:00)	MLS 991240	40	OAS 2 + Owen 34
OBS 325	34°19'47.49" S	73°49'06.43" W		04.03.08	06.04.08	4418	427737 (10.04.08 / 06:30)	MLS 040602	-7	OAS 21 + Owen 15
OBS 324	34°21'14.25" S	73°45'15.58" W		05.03.08	10.04.08	4679	131245 (10.04.08 / 07:00)	MLS 991258	266	HTI 96 + Owen 39
OBS 320	34°26'28.05" S	73°29'25.03" W		05.03.08	10.04.08	5450	442102 (10.04.08 / 07:30)	MLS 040804	208	OAS 81 + Owen 36
OBS 229	34°34'33903" S	74°10.83016" W		05.03.08	05.04.08	4026	143272 (01.04.08 / 09:30)	MLS 020601	115	HTI 80 + Owen 79
OBS 127	34°41'35.34" S	74°13'16.66" W		06.03.08	05.04.08	4155	430274 (10.04.08 / 08:30)	MLS 010408	-31	HTI 53 + Owen 5
OBS 227	34°36'59.62" S	74°02'51.01" W		06.03.08	05.04.08	4510	435517 (10.04.08 / 11:30)	MLS 000708	-268	HTI 94 + Owen 42
OBS 124	34°46.23" S	74°01.53" W		06.03.08	05.04.08	4734	145147 (10.04.08 / 11:00)	MLS 991742	-17	HTI 77 + Owen 55
OBS 224	34°40'54.56" S	73°51'05.26" W		06.03.08	05.04.08	5112	145331 (10.04.08 / 12:00)	MLS 000709	-99	HTI 71 + Owen 13
OBS 121	34°50'38.55" S	73°50'11.85" W		06.03.08	05.04.08	5063	431075 (10.04.08 / 12:30)	MTS 041101	167	HTI 312160 + Owen 03
OBS 701	35°10.00892" S	73°52.95053" W		06.03.08	03.04.08	5077	427260 (10.04.08 / 14:00)	MTS 050811	149	HTI 22 + Owen 55
OBS 221	34°43'39.285" S	73°43'16.315" W		06.03.08	05.04.08	5043	143175 (10.04.08 / 15:30)	MBS 050809	136	HTI 72 + Owen 63

JC23 - short term

INST.	LAT (N) D:M	LONG (E) D:M	DISTANCE TO NEXT	DEPLOY. DATE	RECOV. DATE	DEPTH (m)	RELEASE CODE TIME RELEASE	REC. NO.	SKEW (ms)	SENSORS
OBS 606	34°19'59.7" S	74°15'00.9" W		05.03.08		3909	427332 (01.03.09 / 01:00)	MCS 060717		Guralp 033 + HTI 312115
OBS 605	34°24'59.76" S	73°59'58.84" W		05.03.08		4322	445036 (01.03.09 / 04:30)	MCS 0606115		Guralp 030 + HTI 312127
OBS 604	34°29'58.56" S	73°47'53.73" W		05.03.08		4576	444421 (01.03.09 / 03:00)	MCS 050914		Guralp 058 + HTI
OBS 603	34°37'02.69" S	73°29'01.16" W		05.03.08		5257	443442 (01.03.09 / 00:30)	MCS 050990		Guralp 062 + HTI 312101
OBS 601	34°47'00.95" S	72°56'55.15" W		05.03.08		4352	430637 (01.03.09 / 03:30)	MCS 060708		Guralp 063 + HTI 312097
OBS 602	34°42'02.38" S	73°12'11.26" W		05.03.08		2824	443366 (01.03.09 / 01:30)	MCS 060744		Guralp 064 + HTI 312105
OBS 501	34°29'59.98" S	72°44'56.34" W		04.03.08		4603	444573 (01.03.09 / 02:30)	MCS 060745		Guralp 042 + HTI 312116
OBS 502	34°24'58.22" S	73°04'58.92" W		04.03.08		3397	430021 (01.03.09 / 00:00)	MCS 050902		Guralp 046 + HTI 312132
OBS117	34°56'31.51" S	73°35'12.84" W		07.03.08		5099	533664 (01.03.09 / 12:00)	MCS 060725		Guralp 059 + HTI 312128
OBS700	35°19'59.38" S	73°19'57.81" W		11.03.08		2161	534037 (01.03.09 / 15:00)	MCS 060722		Guralp 047
L01	34°14.99" S	73°22.00" W		06.04.08		5318	134123 (01.03.09 / 18:30)	MLS 040602		HTI 91 + Owen KS0104-008
L02	34°35'30.29" S	72°22'58.90" W		07.04.08		1331	427524 (01.03.09 / 19:00)	MLS 991234		OAS HH + Owen 22
L03	34°38'09.89" S	72°54'06.61" W		07.04.08		875	430067 (01.03.09 / 20:00)	MLS 991243		HTI 70 + Owen 60
L04	35°12'59.71" S	72°49'59.80" W		07.04.08		728	435551 (01.03.09 / 13:00)	MLS 020601		HTI 73 + Owen 24
L05	35°31'58.94" S	73°05'00.12" W		22.03.08		558	432367 (01.03.09 / 12:00)	MTS 070506		HTI 69 + Owen 14
L06	35°05'00.10" S	73°11'57.55" W		07.04.08		2178	435610 (01.03.09 / 12:30)	MLS 991242		HTI 83 + Owen 33
L07	35°26'58.66" S	73°20'01.33" W		07.04.08		1698	133525 (01.03.09 / 13:30)	MLS 040806		HTI 58 + Owen 10
L08	35°14'59.86" S	73°56'01.08" W		03.04.08		5082	427260 (01.03.09 / 21:00)	MTS 050811		HTI 22 + Owen 55

JC23 - long-term

Appendix 15.1. Ocean Bottom Instrumentation

INST.	LAT (N) D:M	LONG (E) D:M	DISTANCE TO NEXT	DEPLOY. DATE	RECOV. DATE	DEPTH (m)	RELEASER CODE TIME RELEASE	REC. NO.	SKEW (ms)	SENSORS
JC23 - Profile 08										
TILT801	34°21'53.09" S	72°32'55.77" W	2 nm	22.03.08	28.03.08	1750	427623 (04.04.08 12:30)	MLS 020303	-27	Tiltmeter
OBS802	34°21'48.15" S	72°33'00.94" W	2 nm	22.03.08	28.03.08	1761	430173 (no TR)	Methan B+D	-	T27 + T30
OBS803	34°21'36.20" S	72°33'03.15" W	2 nm	22.03.08	28.03.08	1781	435704 (04.04.08 09:00)	Methan F	-	T28
OBS804	34°21'24.12" S	72°33'07.89" W	1 nm	22.03.08	28.03.08	1823	427430 (04.04.08 08:00)	Methan C	-	T29
OBS805	34°20'22.00" S	72°33'09.12" W	1 nm	22.03.08	23.03.08	1817	435551 (04.04.08 12:00)	MES 030904	-1	HTI 50 + Owen 33
OBS806	34°19'26.67" S	72°33'24.66" W	1 nm	22.03.08	23.03.08	1727	133525 (04.04.08 10:30)	MBS 000614	-4	HTI 73 + Owen 24
OBS807	34°18'25.18" S	72°33'31.39" W	1 nm	22.03.08	23.03.08	1653	133770 (04.04.08 13:00)	MES 031002	-83	HTI 58 + Owen 10
JC23 - Profile 09										
OBS 901	35°43'13.97" S	73°18'40.72" W	1.6 nm	28.03.08	29.03.08	979	435610 (01.03.09 12:30)	MBS 980903	3	HTI 50 + Owen 33
OBS 902	35°42'10" S	73°22'17.02" W	1.5 nm	28.03.08	29.03.08	1551	435551 (01.03.09 13:00)	MBS 020505	-	HTI 73 + Owen 24
OBS 903	35°41'42" S	73°24'09" W	1.6 nm	28.03.08	29.03.08	1655	133525 (01.03.09 13:30)	MBS 020504	7	HTI 58 + Owen 10
OBS 904	35°41'10.86" S	73°25'57.77" W	1.5 nm	28.03.08	29.03.08	1782	133770 (01.03.09 14:00)	MBS 020508	-1	HTI 60 + Owen 75
OBS 905	35°40'41.89" S	73°27'43.77" W	1.5 nm	28.03.08	29.03.08	1833	250177 (01.03.09 14:30)	MES 030905	-2	HTI 48 + Owen 59
OBS 906	35°40'13.80" S	73°29'28.26" W	1.5 nm	28.03.08	29.03.08	1833	430173 (no TR)	MBS 000614	-9	HYD + Owen
OBS 907	35°39'50.62" S	73°30'53.41" W	1.2 nm	28.03.08	29.03.08	1895	435704 (04.04.08 7:00)	MBS 020507	17	HYD + Owen 76
OBS 908	35°39'10.50" S	73°33'29.26" W	2.2 nm	28.03.08	29.03.08	2200	427430 (04.04.08 8:00)	MES 030901	-82	HTI 29 + Owen 29
OBS 909	35°38'4260" S	73°35'1387" W	1.5 nm	28.03.08	29.03.08	2273	427623 (04.04.08 12:30)	MBS 010708	-4	HTI 64 + Owen
OBS 910	35°38'14.00" S	73°36'58.42" W	1.5 nm	28.03.08	29.03.08	2209	534224 (04.04.08 11:30)	MBS 020501	3	HTI 56 + Owen 23
OBS 911	35°37'44.02" S	73°38'38.70" S	1.5 nm	28.03.08	29.03.08	2550	9256	MBS 020503	6	HTI 85
OBS 912	35°37'24.19" S	73°39'54.85" W	1.1 nm	28.03.08	29.03.08	2679	533770 (04.04.08 09:30)	MBS 001003	no skew	HTI 33
OBS 913	35°36'31.25" S	73°43'13.23" W	2.8 nm	28.03.08	29.03.08	4067	134123 (04.04.08 11:00)	MBS 000616	-24	HYD 30 + Owen 8
OBS 914	35°36'02.13" S	73°44'58.65" W	1.5 nm	28.03.08	29.03.08	4424	427524 (04.04.08 10:00)	MBS 001001	-8	HTI 91 + Owen
OBS 915	35°25'32.56" S	73°46'44.61" W	1.5 nm	28.03.08	30.03.08	4929	134037 (04.04.08 22:00)	MBS 010703	-6	HYD 04 + Owen 60
OBS 916	35°35'03.24" S	73°48'31.08" W	1.5 nm	28.03.08	30.03.08	4908	430067 (04.04.08 01:00)	MBS 980905	1	HYD (418) + Owen 22
OBS 917	35°34'34.11" S	73°50'08.74" W	-	28.03.08	30.03.08	4904	133664 (04.04.08 03:00)	MES 030904	-2334	HTI 79 + Owen 81

Appendix 15.1. Ocean Bottom Instrumentation

INST.	LAT (N) D:M	LONG (E) D:M	DISTANCE TO NEXT	DEPLOY. DATE	RECOV. DATE	DEPTH (m)	RELEASER CODE TIME RELEASE	REC. NO.	SKEW (ms)	SENSORS
OBS 1001	36°02'56.90" S	73°39'20.41" W	0.97 nm	30.03.08		1128	533770 (01.03.09 18:00)	MBS 980903		OAS 50 + Owen 27
OBH1002+Meth	36°02'08.78" S	73°38'42.32" W	0.98 nm	30.03.08		979	534224 (01.03.09 17:30)	MBS 001003		OAS 33
OBH 1003+Meth	36°01'19.41" S	73°38'02.77" W	1.06 nm	30.03.08	02.04.08	1029	131351 (01.03.09 15:00)	MBS 020503	16	OAS 56
OBH 1004+Meth	36°00'23.64" S	73°37'23.88" W	1.31 nm	30.03.08	02.04.08	1029	435704 (01.03.09 17:00)	MBS 001001	-28	HTI 29
OBS 1005	35°59'16.17" S	73°36'35.78" W	1.3 nm	30.03.08	02.04.08	1041	427430 (01.03.09 16:30)	MBS 020504	22	OAS 30 + Owen 76
OBS 1006	35°58'10.41" S	73°35'43.53" W	1.26 nm	30.03.08	02.04.08	1071	134071 (01.03.09 19:30)	MBS 020508	-1	HTI 14 + Owen 48
OBS 1007	35°57'05.58" S	73°34'54.81" W	1.17 nm	30.03.08	02.04.08	1141	250177 (01.03.09 14:30)	MBS 000614	-30	OAS 14 + Owen 52
OBS 1008	35°56'04.00" S	73°34'11.16" W	0.99 nm	30.03.08	02.04.08	1210	133770 (01.03.09 14:00)	MBS 020501	-254	HTI 60 + Owen 24
OBS 1009	35°55'13.74" S	73°33'32.10" W	1.42 nm	30.03.08	02.04.08	1450	133525 (01.03.09 13:30)	MES 031001	177	HTI 58 + Owen 10
OBS 1010	35°54'02.51" S	73°32'29.50" W	1.36 nm	30.03.08	02.04.08	1485	435551 (01.03.09 13:00)	MBS 000616	-74	HTI 73 + Owen 32
OBS 1011	35°52'52.38" S	73°31'45.79" W	0.98 nm	30.03.08	02.04.08	1439	435610 (01.03.09 12:30)	MBS 980905	3	HTI 88 + Owen 33
OBS 1012	35°52'03.90" S	73°31'05.13" W	1 nm	30.03.08	02.04.08	1426	427524 (01.03.09 19:00)	MBS 000611	-12	OAS H + Owen 22
OBS 1013	35°51'12.70" S	73°30'28.92" W	-	30.03.08	02.04.08	1402	134123 (01.03.09 18:30)	MES 031002	347	HYD + Owen

JC23 - Profile 10

INST.	LAT (N) D:M	LONG (E) D:M	DISTANCE TO NEXT	DEPLOY. DATE	RECOV. DATE	DEPTH (m)	RELEASER CODE TIME RELEASE	REC. NO.	SKEW (ms)	SENSORS
OBS 1101	36°21'33.36" S	73°42'10.66" W	0.27 nm	12.04.08	15.04.08	1025	430232 (02.03.09 01:00)	MBS 980905	-406	HTI 26 + Owen 16
OBS 1102	36°21'50.31" S	73°42'11.93" W	0.24 nm	12.04.08	15.04.08	999	430424 (02.03.09 01:30)	MBS 020503	14	HTI 31 + Methan F / T27
OBS 1103	36°22'04.27" S	73°42'11.32" W	0.24 nm	12.04.08	15.04.08	957	143175 (01.03.09 23:00)	MES 030901	-243	HTI 72 + Owen 63
OBS 1104	36°22'17.44" S	73°42'10.49" W	0.25 nm	12.04.08	15.04.08	954	145331 (01.03.09 23:30)	MLS 040804	18	HTI 71 + Owen 13
OBS 1105	36°22'32.74" S	73°42'10.76" W	0.55 nm	12.04.08	15.04.08	920	143272 (01.03.09 00:00)	MLS 991258	21	HTI 80 + Owen 79
OBS 1106	36°23'06.42" S	73°42'11.51" W	0.55 nm	12.04.08	15.04.08	943	145147 (01.03.09 22:00)	MTS 041103	-10	HTI 77 + Owen 55
OBS 1107	36°23'39.52" S	73°42'12.28" W	0.55 nm	12.04.08	15.04.08	931	533770 (01.03.09 18:00)	MBS 000616	-70	HTI 50 + Owen 27
OBS 1108	36°24'12.31" S	73°42'12.81" W	0.52 nm	12.04.08	15.04.08	909	131351 (01.03.09 15:30)	MES 030903	no skew	HTI 56 + Owen 53
OBS 1109	36°24'43.78" S	73°42'12.55" W	0.26 nm	12.04.08	15.04.08	922	534224 (01.03.09 17:30)	MTS 041101	18	HTI 312 + Owen 62
OBS 1110	36°24'59.61" S	73°42'12.06" W	0.16 nm	12.04.08	15.04.08	886	431075 (01.03.09 22:30)	MBS 990712	-8	HTI 28 + Owen 03
OBS 1111	36°25'08.19" S	73°42'13.64" W	0.14 nm	12.04.08	15.04.08	680	427430 (01.03.09 16:30)	MBS 001003	11	HTI 49 + Methan C / T29
OBS 1112	36°25'16.29" S	73°42'13.39" W	0.27 nm	12.04.08	15.04.08	795	435704 (01.03.09 17:00)	MBS 020501	9	HTI 29 + Owen 56
OBS 1113	36°25'31.99" S	73°42'13.46" W	0.35 nm	12.04.08	15.04.08	689	250177 (01.03.09 14:30)	MTS 050809	12	HTI 78 + Owen 59
OBS 1114	36°25'53.22" S	73°42'13.89" W	0.32 nm	12.04.08	15.04.08	752	133770 (01.03.09 14:00)	MLS 991240	2	HTI 60 + Owen 75
OBS 1115	36°26'11.46" S	73°42'13.68" W	0.27 nm	12.04.08	15.04.08	757	133664 (01.03.09 21:30)	MBS 991292	-9	HTI 79 + Owen 81
OBS 1116	36°26'28.12" S	73°42'13.23" W	0.17 nm	12.04.08	15.04.08	731	131245 (02.03.09 03:00)	MLS 000708	-29	HTI 81 + Owen 36
OBS 1117	36°26'38.35" S	73°42'13.26" W	0.16 nm	12.04.08	15.04.08	728	134071 (01.03.09 19:30)	MBS 001001	-28	HTI 48 + Methan B / T28
OBS 1118	36°26'47.71" S	73°42'13.80" W	0.27 nm	12.04.08	15.04.08	733	442102 (02.03.09 02:30)	MES 030905	-5	HTI 96 + Owen 39
OBS 1119	36°27'03.63" S	73°42'13.33" W	-	12.04.08	15.04.08	766	431501 (02.03.09 03:00)	MBS 000614	-28	HTI 68 + Owen 34

JC23 - Profile 11

Appendix 15.1. Ocean Bottom Instrumentation

INST.	LAT (N) D:M	LONG (E) D:M	DISTANCE TO NEXT	DEPLOY. DATE	RECOV. DATE	DEPTH (m)	RELEASE CODE TIME RELEASE	REC. NO.	SKEW (ms)	SENSORS
OBS1201	35°30'54.84" S	73°24'18.54" W	0.4 nm	08.04.08	11.04.08	1195	131351 (01.03.09 15:30)	MTS 041103	-11	HTI 56 + Owen 53
OBS1202	35°31'02.36" S	73°29'50.05" W	0.4 nm	08.04.08	11.04.08	1218	533770 (01.03.09 18:00)	MLS 041101	18	HTI 50 + Owen 27
OBS1203	35°31'10.59" S	73°32'23.10" W	0.4 nm	08.04.08	11.04.08	1084	145147 (01.03.09 22:00)	MBS 980905	3	HTI X7 + Owen 55
OBS1204	35°31'19.14" S	73°22'52.71" W	0.2 nm	08.04.08	11.04.08	1261	431075 (01.03.09 22:30)	MBS 020508	-2	HTI 28 + Owen 63
OBS1205	35°31'29.07" S	73°22'19.09" W	0.1 nm	08.04.08	11.04.08	1438	143175 (01.03.09 23:00)	MES 030904	174	HTI 7 + Owen 63
OBS1206	35°31'32.46" S	73°22'08.34" W	0.1 nm	08.04.08	11.04.08	1451	145331 (01.03.09 23:30)	MBS 000614	-31	HTI 71 + Owen 13
OBS1207	35°31'35.11" S	73°22'00.16" W	0.1 nm	08.04.08	11.04.08	1420	143272 (01.03.09 00:00)	MBS 020501	10	HTI 80 + Owen 79
OBS1208	35°31'37.74" S	73°21'49.92" W	0.5 nm	08.04.08	11.04.08	1448	435517 (02.03.09 00:30)	MES 030901	-251	HTI 94 + Owen 42
OBS1209	35°31'48.60" S	73°21'17.88" W	0.5 nm	08.04.08	11.04.08	1449	430232 (02.03.09 01:00)	MBS 000616	-77	HTI 26 + Owen 16
OBS1210	35°31'58.62" S	73°20'43.47" W	0.5 nm	08.04.08	11.04.08	1559	430424 (02.03.09 01:30)	MES 031002	359	HYD 302 + Owen 38
OBS1211	35°32'07.89" S	73°20'10.10" W	0.5 nm	08.04.08	11.04.08	1613	427737 (02.03.09 02:00)	MES 031001	256	OAS 1 + Owen 15
OBS1212	35°32'17.82" S	73°19'36.30" W	6.7 nm	08.04.08	11.04.08	1668	430274 (02.03.09 01:30)	MES 030905	-5	HTI 53 + Owen 5
OBS1213	35°29'34.78" S	73°23'15.78" W	0.7 nm	08.04.08	11.04.08	1383	534224 (01.03.09 17:30)	MBS 990712	-12	HTI 33 + Owen 62
OBS1214	35°29'49.21" S	73°22'28.30" W	0.5 nm	08.04.08	11.04.08	1369	435704 (01.03.09 17:00)	MTS 050809	14	HTI 29 + Owen 56
OBS1215	35°29'59.07" S	73°21'54.18" W	0.9 nm	08.04.08	11.04.08	1451	427430 (01.03.09 16:30)	MTS 000708	-30	HTI 30 + Owen 76
OBS1216	35°30'18.40" S	73°20'53.08" W	0.6 nm	08.04.08	11.04.08	1528	134071 (01.03.09 19:30)	MES 030903	140	HTI 48 + Owen 41
OBS1217	35°30'29.95" S	73°20'14.65" W	0.3 nm	08.04.08	11.04.08	1582	250177 (01.03.09 14:30)	MBS 991292	-	OAS 14 + Owen 59
OBS1218	35°35'46.31" S	73°19'55.09" W	0.3 nm	08.04.08	11.04.08	1620	133770 (01.03.09 14:00)	MBS 980903	8	HTI 60 + Owen 75
OBS1219	35°30'38.71" S	73°19'38.77" W	-	08.04.08	11.04.08	1680	133664 (01.03.09 21:30)	MBS 020504	22	HTI 79 + Owen 81

JC23 - Profile 12

APPENDIX 15.2.1 - Airgunshots P01

Gun 1	Gun 2	Gun 3	Gun 4	Gun 5	Gun 6	Gun 7	Gun 8	Gun 9	Gun 10	Gun 11	Gun 12	Gun 13	Gun 14	Gun 15
				21:10 on										
					21:15 on									
						21:20 on						21:25 on		
													21:30 on	
							21:40 on							21:35 on
								21:45 on						
09.03.08														
								11:03 off						
							11:35 off							
							13:05 on							
							14:15 off					14:05 off	14:05 off	
							14:46 on							
									14:52 on					
										14:58 on				
											15:03 on			
												15:08 on		
													15:14 on	
														15:19 on
							19:02 off							
				19:49 off	19:49 off	19:49 off								
									19:49 off	19:49 off	19:49 off	19:49 off	19:49 off	19:49 off
19:57 End of Line 1 - 35.332° S // 72.612° W														
19:58 Start of Line 11 turn - 35.333° S // 72.613° W														
20:30 off														
					20:30 on	20:30 on								
										20:35 on				
Firing interval changed to 40 sec														
											20:40 on			
													20:45 on	
														20:50 on
21:04 Decision made to fire no more than 8 guns														
21:19 End of Line 11 turn - 35.394° S // 72.681° W														
21:22 Start of Line 11 - 35.391° S // 72.679° W														
23:22 End of Line 11 - all guns stopped - 35.251° S // 72.580° W														

APPENDIX 15.2.3 - Airgunshots P03

Gun 1	Gun 2	Gun 3	Gun 4	Gun 5	Gun 6	Gun 7	Gun 8	Gun 9	Gun 10	Gun 11	Gun 12	Gun 13	Gun 14	Gun 15
13.03.2008														
11:46 Start of Line 3 - 34.054° S // 74.628° W														
11:46 on														
	11:51 on													
		11:56 on												
			12:01 on											
12:04 off							12:04 on							
	12:05 off	12:05 off							12:05 on	12:05 on	12:05 on			
												12:06 on		
													12:11 on	
12:22 on							12:17 on							
	12:27 on													
		12:32 on												
				12:37 on										
					12:42 on									
12:46 Firing rate changed from 40 sec to 60 sec														
						12:47 on								
14.03.2008														
							17:06 off							
17:09 End of Line 3, Start of Line 33 turn - 34.844° S // 72.301° W														
17:14 off	17:14 off	17:14 off	17:14 off	17:14 off	17:14 off	17:14 off								
									17:15 off			17:15 off	17:15 off	
17:37 Firing rate changed from 60 sec to 40 sec														
													18:18 on	
		18:24 on												
							18:35 on							
18:53 on				18:53 on									18:53 off	18:53 off
18:56 Decision made to fire no more than 8 guns due to shallow water														
					19:12 on									
19:15 End of Line 33 turn, Start of Line 33 - 34.910° S // 72.349° W														
19:16 off				19:16 off									19:16 on	19:16 on
22:05 End of Line 33 - all guns stopped - 34.690° S // 72.243° W														

APPENDIX 15.2.4 - Airgunshots P04

Gun 1	Gun 2	Gun 3	Gun 4	Gun 5	Gun 6	Gun 7	Gun 8	Gun 9	Gun 10	Gun 11	Gun 12	Gun 13	Gun 14	Gun 15
16.03.2008														
07:40 Soft Start of Line 4 - 34.896° S // 74.317° W														
07:40 on														
	07:45 on													
		07:50 on												
			07:55 on											
			08:00 off						08:00 on					
										08:05 on				
											08:10 on			
												08:15 on		
08:16 off			08:16 on											
					08:20 on									
						08:25 on								
														08:30 on
08:35 on							08:40 on							
							16:36 off							
16:50 End of Line 4 - all guns stopped - 34.185° S // 73.984° W														

APPENDIX 15.2.5 - Airgunshots P08 - P09

P08

GI Gun 1	GI Gun 3	GI Gun 10	GI Gun 11	GI Gun 12
22.03.2008				
20:14 on		20:14 Soft Start of Line HP8		
	20:20 on			
		20:33 gun 1 g30 ms i84, gun 3 g30 ms i84		
		20:48 gun 1 g30.5 ms i84, gun 3 g29.2 ms i83		
		22:01 End of Line HP8 - all guns stopped		
		23:02 Start of Line HP81		
		23:02 on	23:08 on	
				23:14 on
		23:28 gun 10 g30 ms, gun 11 g30.3 ms, gun 12 g30.5 ms		
23.03.2008				
		00:10 End of Line HP81 - all guns stopped		

P09

GI Gun 1	GI Gun 3	GI Gun 4
29.03.2008		
02:17 on	02:14 Start of Line P09 - 35°33.45' S // 73°54.50' W	
		02:22 on
		02:27 on
02:37 Gun 1 30.4ms, Sol 5 84ms; Gun4 20.0ms, sol6 94ms; gun3 29.3ms sol7 83ms		
07:44 Gun 1 30.2ms, Sol 5 84 ms. Gun 4 29.9 ms, sol 6 84ms, gun 3 29.7 ms sol 7 84 ms		
09:15 End of Line P09 - all guns stopped - 35°43.66' S // 73°16.91' W		

APPENDIX 15.2.6 - Airgunshots P10

GI Gun 1	GI Gun 3	GI Gun 4
30.03.2008		
16:15 Start of Line P10 - 35°46.8'S // 73° 27.2'W		
16:15 on		16:20 on
	16:25 on	
16:30 firing stopped		
16:57 end of line P10 - guns stopped to recover - 36°05.7'S // 73°41.4' W		
17:46 start of line P10a - 36°08,0'S // 73°45,3'W		
17:46 on		17:53 on
	19:28 gun1 30.1/gun4 30.2ms	
23:42 End of Line P10a - all guns stopped - 35°05.7'S // 73°41.4' W		
31.03.2008		
04:23 on		
04:26 Start of Line P10b - 36°03.8'S // 73°42.2'W		
04:23 on		04:28 on
	04:33 on	
04:52 Gun 1 29.9ms Inj 84ms, Gun4 29.8ms Inj 84ms, Gun 3 29.5 ms Inj 84ms		
05:15 Gun 1 30ms, Gun 4 30.2ms, Gun 3 29.8ms, all Inj @ 84ms		
13:31 end of line P10b - 35°44.6'S // 73°27.7'W		
14:48 start of Line P10d - 35°44,8'S // 73°24,7'W		
14:49 on		
	14:54 on	
		14:59 on
18:20 guns stopped because of whales		
18:42 restarting guns		
23:06 End of Line P10d - 36°06,1'S // 73°40,6'W		
01.04.2008		
00:17 commence soft start of Line P10e - 36°05,9'S // 73°42,7'W		
00:19 on		00:24 on
	00:30 on	
	00:33 start of Line P10e	
07:15 End of Line P10e - 35°45,2'S // 73°27,0'W		
09:31 commence soft start of Line P10f		
09:33 on		
		09:38 on
	09:43 on	
09:58 Start of Line P10f - 35°47,5'S // 73°25,5'W		
02.04.2008		
02:51 End of Line - guns stopped - 36°34,5'S // 73°41,7'W		

APPENDIX 15.2.7 - Airgunshots P11 - P12 - P13

P11

GI Gun 1	GI Gun 3	GI Gun 4
	12.04.2008	
	07:25 Start of Line P11 - 36°18,7'S // 73°42,1'W	
	20:48 Interruption of P11 - all guns stopped because of whales	
	21:30 commence soft start of line P13b	
21:30 on	21:35 on	21:40 on
	21:42 start of line P11b	
	13.04.2008	
	23:48 End of Line P11b - all guns stopped - 36°18,1' S // 73° 41,2' W	

P12

GI Gun 1	GI Gun 3	GI Gun 4
	08.04.2008	
	13:50 Start of Line P12 - 35°33,0'S // 37°17,4'W	
	09.04.2008	
	16:58 End of Line P12 - 35°29,1'S // 73°18,8'W	

P13

GI Gun 1
16.04.2008
18:00 Start of Line 13 - 34°15,3'S // 73°12,8'W
23:31 End of Line 13 - gun stopped - 34°16,3'S // 73° 07,1'W

Appendix 15.3: Gravity

NMFD Gravimeter Port Tie In FormShip: James Cook Cruise: JC23bPrinciple Scientist: Jorg Bialas**Details of Ship Fitted Gravity Meter:**Make: Micro-g-Lacoste
Type: AirSea 2
Serial No: S84 PM1**Details of Land Gravity meter used for the tie in readings:**Make: Worden
Type: 212
Serial No: 701
Calibration factor (microgals / div): 0,094**Location where Tie In needs to be calculated:**Port: Valparaiso, Chile
Berth No: _____
Coordinates (Lat / Long): 33dg 09'09.84 S, 071dg 37'33.04 W**Location of Known Gravity Base Station:**ISGN Station No: Not Known
Address: SHOA
Errazuriz 254
Playa Ancha,
Valparaiso, ChileContact Person (If any): Capt. Andres Enriquez
Tel no. / e-mail: +56 32 226667
Coordinates (Lat / Long): 33dg 01'41.66 S, 071dg 38'08.37 WAbsolute gravity value in microgals: 979607089,2

Comments: _____

Appendix 15.3: Gravity

Readings PageDate: 25.03.2008 Julian Day No: 2008085

First set of readings on quay wall adjacent to ship:

Counter Reading 1:	<u>1180,8</u>	@ time:	<u>16:20</u>
Counter Reading 2:	<u>1179,1</u>	@ time:	<u>16:25</u>
Counter Reading 3:	<u>1183,7</u>	@ time:	<u>16:26</u>
Counter Reading 4:	<u>1182,0</u>	@ time:	<u>16:27</u>
Counter Reading 5:	<u>1188,8</u>	@ time:	<u>16:34</u>

Height of Gravity Meter above water level (h1): 3,1 meters

Set of readings at the known base station:

Counter Reading 1:	<u>1058,9</u>	@ time:	<u>17:28</u>
Counter Reading 2:	<u>1058,3</u>	@ time:	<u>17:30</u>
Counter Reading 3:	<u>1059,0</u>	@ time:	<u>17:32</u>
Counter Reading 4:	<u>1059,1</u>	@ time:	<u>17:34</u>
Counter Reading 5:	<u>1059,5</u>	@ time:	<u>17:36</u>

Second set of readings on quay wall adjacent to ship:

Counter Reading 1:	<u>1181,8</u>	@ time:	<u>18:32</u>
Counter Reading 2:	<u>1181,0</u>	@ time:	<u>18:34</u>
Counter Reading 3:	<u>1183,4</u>	@ time:	<u>18:37</u>
Counter Reading 4:	<u>1183,9</u>	@ time:	<u>18:38</u>
Counter Reading 5:	<u>1182,5</u>	@ time:	<u>18:40</u>

Height of Gravity Meter above water level (h2): 3,3 metersHeight of ships GM above static water line (h3): 1,9 metresDigital Gravity Reading shown on ships GM display: 10821,6

Appendix 15.3: Gravity

Calculations page

Tidal Calculations: (Obtain (a),(b) and (d) below from UK Hydrographic tables)

Height of last Low Water (a): 1,5 metres

Height of next High Water (b): 0,5 metres

Tidal Range (c): -1,0 metres

Height of tide above LW at average time of readings (d): 1,0 metres

Height of tide above mean sea level ((d-c/2) =e): 1,5 metres

Average height of Land GM above waterline ((h1-h2)/2=f): -0,1 metres

Average height of Land GM above mean sea level (e + f =g): 1,4 metres

Difference in height between Land GM and Ship GM (f - h3): -2,0 metres

Free Air corrected value for height difference (0.31 x (f-h3)): -0,6 metres

Average of the first set of quay wall readings (S1): 1182,9 Counter divs

Average of the second set of quay wall readings (S2): 1182,5 Counter divs

Average of the Known base station readings (S3): 1059,0 Counter divs

Difference in minutes between first and second sets of quay wall readings (ST2 - ST1): 1,0 Mins

Drift of Land GM ((S1-S2)/ST2-ST1 = k): 0,4 Counter divs

Difference in minutes between Known Base station readings and first quay wall readings (ST3): 67,0 Mins

Corrected quay wall reading at the time of Base station reading: (S1 + (ST3 x k)=m): 1207,0 Counter divs

Difference between quay wall reading and known base (S2-m-S3 =N): -1083,4 Counter divs

Converted value (calibration factor x N): -101,8 μ gals

Absolute value at the quay wall (Known value + converted value): **979606987,34** μ gals

Absolute value at ships GM (abs. quay wall value + free air corrected value): **979606986,72** μ gals

Appendix 15.3: Gravity

NMFD Gravimeter Port Tie In FormShip: James Cook Cruise: JC23bPrinciple Scientist: Jorg Bialas**Details of Ship Fitted Gravity Meter:**Make: Micro-g-Lacoste
Type: AirSea 2
Serial No: S84 PM1**Details of Land Gravity meter used for the tie in readings:**Make: Worden
Type: 212
Serial No: 701
Calibration factor (microgals / div): 0,094**Location where Tie In needs to be calculated:**Port: Valparaiso, Chile
Berth No: _____
Coordinates (Lat / Long): 33dg 02.16515 S, 071dg 37.532314 W**Location of Known Gravity Base Station:**ISGN Station No: Not Known
Address: SHOA
Errazuriz 254
Playa Ancha,
Valparaiso, ChileContact Person (If any): Capt. Andres Enriquez
Tel no. / e-mail: +56 32 226667
Coordinates (Lat / Long): 33dg 01'41.66 S, 071dg 38'08.37 WAbsolute gravity value in microgals: 979607089,2

Comments: _____

Appendix 15.3: Gravity

Readings PageDate: 18.04.2008 Julian Day No: 2008109

First set of readings on quay wall adjacent to ship:

Counter Reading 1:	<u>1211,8</u>	@ time:	<u>10:15</u>
Counter Reading 2:	<u>1208,7</u>	@ time:	<u>10:17</u>
Counter Reading 3:	<u>1209,3</u>	@ time:	<u>10:19</u>
Counter Reading 4:	<u>1209,4</u>	@ time:	<u>10:23</u>
Counter Reading 5:	<u>1208,0</u>	@ time:	<u>10:25</u>

Height of Gravity Meter above water level (h1): 3,3 meters

Set of readings at the known base station:

Counter Reading 1:	<u>1085,3</u>	@ time:	<u>11:35</u>
Counter Reading 2:	<u>1086,2</u>	@ time:	<u>11:37</u>
Counter Reading 3:	<u>1086,2</u>	@ time:	<u>11:40</u>
Counter Reading 4:	<u>1086,1</u>	@ time:	<u>10:33</u>
Counter Reading 5:	<u>1086,0</u>	@ time:	<u>11:47</u>

Second set of readings on quay wall adjacent to ship:

Counter Reading 1:	<u>1208,3</u>	@ time:	<u>12:10</u>
Counter Reading 2:	<u>1206,5</u>	@ time:	<u>12:12</u>
Counter Reading 3:	<u>1207,2</u>	@ time:	<u>12:14</u>
Counter Reading 4:	<u>1206,3</u>	@ time:	<u>12:15</u>
Counter Reading 5:	<u>1206,5</u>	@ time:	<u>12:16</u>

Height of Gravity Meter above water level (h2): 3,6 metersHeight of ships GM above static water line (h3): 1,9 metresDigital Gravity Reading shown on ships GM display: 10817,3

Appendix 15.3: Gravity

Calculations page

Tidal Calculations: (Obtain (a),(b) and (d) below from UK Hydrographic tables)

Height of last Low Water (a): 0,4 metres

Height of next High Water (b): 1,4 metres

Tidal Range (c): 1,0 metres

Height of tide above LW at average time of readings (d): 0,9 metres

Height of tide above mean sea level ((d-c/2) =e): 0,4 metres

Average height of Land GM above waterline ((h1-h2)/2=f): -0,2 metres

Average height of Land GM above mean sea level (e + f =g): 0,3 metres

Difference in height between Land GM and Ship GM (f - h3): -2,1 metres

Free Air corrected value for height difference (0.31 x (f-h3)): -0,6 metres

Average of the first set of quay wall readings (S1): 1209,4 Counter divs

Average of the second set of quay wall readings (S2): 1207,0 Counter divs

Average of the Known base station readings (S3): 1086,0 Counter divs

Difference in minutes between first and second sets of quay wall readings (ST2 - ST1): 112,0 Mins

Drift of Land GM ((S1-S2)/ST2-ST1 = k): 0,0 Counter divs

Difference in minutes between Known Base station readings and first quay wall readings (ST3): 80,0 Mins

Corrected quay wall reading at the time of Base station reading: (S1 + (ST3 x k)=m): 1211,2 Counter divs

Difference between quay wall reading and known base (S2-m-S3 =N): -1090,2 Counter divs

Converted value (calibration factor x N): -102,5 μ gals

Absolute value at the quay wall (Known value + converted value): **979606986,70** μ gals

Absolute value at ships GM (abs. quay wall value + free air corrected value): **979606986,06** μ gals

Appendix 15.4: Scripts for processing of multibeam data

A-1: Script for preprocessing of multibeam data:

`prepare_work.sh`

```
#!/bin/bash
#####
# Author Stefan Ladage
# BGR - Germany
#

if [ $# != 2 ]
then
    echo "Usage: `basename $0` cruise subdir"
    exit
fi

cruise=$1
subdir=`basename $2`
# Test if there is such a subdir

datapath="/data1/Chile/$cruise"
raw_dir="$datapath/raw_em120"
work_dir="$datapath/work_em120"
script_dir= "`basename $0`"

if [ ! -d $raw_dir/$subdir ]
then
    echo " Alert: $subdir does not exist in RAW Dir $raw_dir"
    exit
fi
#

##### functions #####
# copy and reformat to 57
function reformat () {
    outfile=`basename $1 .all`.mb57
    echo "IN: $1   OUT: $outfile   "
    if [ -r $outfile ]
    then
        echo ".... $outfile already exists ==> skipped"
    else
        echo -en "mb copying      ...\r"
        mbcopy -P1 -F56/57 -S2 -I$1 -O${outfile}
        echo -en "mb datalisting  ...\r"
        mbdatalist -N -I${outfile}
        echo -en "mb svp listing  ...\r"
        mbsvplist -I${outfile} -O
        echo "${outfile} 57" >> datalist.mb-1
        echo -en "mb setting metadata  ...\r"
        metainfo.cmd ${outfile}
        echo -en "mb setting metadata  ... mbprocessing \r"
        mbprocess -I${outfile}
    fi
}

function file_list () {
    echo creating datafile list ....
    ls -l *.mb57 | awk ' { print $1, 57}' > file57.mb-1
}
```

```

}

function new_dir () {
# creates a corresponding work-subdir to raw-dir
# initiates the datalist in the new subdir
# creates or appends this datalist to the workdir datalist of that subdir
# eg. (datalist_S0186_003.mb-1)
# creates or appends this to cruise-datalist in the workdir.
if [ ! -d $raw_dir/$subdir ]; then
    echo " Alert: $subdir does not exist in RAW Dir
$raw_dir"
        exit
    else
        echo "Working on files in ==> $raw_dir/$subdir"
    fi
    if [ -d $work_dir/$subdir ]; then
        echo "Appending files in ==> $work_dir/$subdir"
    else
        mkdir -pv $work_dir/$subdir
        lastreturn=$?
        if [ $lastreturn -gt 0 ] ; then
            echo " Alert: could not create
$work_dir/$subdir !! exit $lastreturn"
            exit
        fi
        echo "Writing files in ==> $work_dir/$subdir"
        make_datalist $work_dir/$subdir
    fi
    echo "${subdir}/datalist.mb-1" >
$work_dir/datalist_${subdir}.mb-1
    echo "datalist_${subdir}.mb-1" >> $work_dir/datalist.mb-
1
}

function data_list () {
    echo executing datalist in dir ....
    mbdatalist -N -I $1
}

function SVP_out () {
    echo getting sound velocities ....
    mbsvplist -F-1 -I$1 -O
}

function make_datalist () {
    datalistfile=${1}/datalist.mb-1
    if [ ! -s $datalistfile ]
        then
            echo '$PROCESSED' > $datalistfile
            echo "Created $datalistfile"
        fi
}

function plot {
    datlist=$1
    mbm_plot -I${datlist} -G2 -PA4 -MGDDEGREE_FORMAT/3 -V
    cp -p ${datlist}.cmd temp.cmd_$$
}

```

```
sed '/PAPER_MEDIA/s/A4+/A4/g' temp.cmd_$$ > ${datlist}.cmd
rm -f temp.cmd_$$
${datlist}.cmd
}
```

```
##### main #####
#Check and prepare subdirs as needed
```

```
new_dir
```

```
cd $work_dir/$subdir
```

```
for ifile in ${raw_dir}/${subdir}/*.all
do
    reformat $ifile
done
```

```
cd $work_dir
```

```
echo "Plotting ..."
plot datalist_${subdir}.mb-1
```

```
exit
```

A-2: Script for grid calculation of multibeam data:**process.cmd**

```

#!/bin/csh -f
#
if ( -f .hsdefaults ) then
    source .hsdefaults
else
    echo "cannot find your .hsdefaults file \!"
    exit
endif
#
#####
#####
#
# set your parameters here...
# =====
# choose grid size, clip radius, and the name of
# your datalist file
#
#####
#####
#
set datalist      = datalist_all.mb-1
#
set DX            = 150    # dx in m for grid calculation with mbgrid
set DY            = 150    # dy in m for grid calculation with mbgrid
set UNIT          = meters # units for grid cells: meters | degrees
set DAT_TYP      = 2      # datatype                check man mbgrid!
set CLIP         = 4      # interpolation radius    check man mbgrid!
set MODE         = 1      # interpolation mode      check man mbgrid!
set GRDALG       = 1      # gridding algorithm     check man mbgrid!
set GRDKIND      = 3      # gridkind               check man mbgrid!
set SPEED        = 4      # minimum ship speed in km/h - data
                        # recorded at slower speed are ignored

#
#####
#
#####
#
#####
#
# Run mbgrid
    echo Running mbgrid...
#
#
mbgrid -I$datalist -O${F_NAME}__${DX}_${DY}_z \
    -A${DAT_TYP} -C${CLIP}/${MODE} \
    -F${GRDALG} -G${GRDKIND} -N \
    -R${REGION_GRID} -S$SPEED -E${DX}/${DY}/${UNIT}
#
#
#####
#####
#
# All done
echo All done...

```

A-3: Script for plotting of digital terrain models:**fig_bathy.cmd**

```

#!/bin/csh -f
#
#####
###
### maybe you want to change these gmtdefault values?
###
#####
#
gmtdefaults -D > .gmtdefaults
gmtset PAPER_MEDIA A4
gmtset PAGE_ORIENTATION LANDSCAPE
gmtset PLOT_DEGREE_FORMAT ddd:mmF
gmtset D_FORMAT %4.0f
gmtset ANOT_FONT_SIZE 10
gmtset LABEL_FONT_SIZE 10
gmtset GRID_CROSS_SIZE 0
gmtset GRID_PEN 0
gmtset BASEMAP_TYPE PLAIN
gmtset COLOR_NAN 255/255/255
gmtset WANT_EURO_FONT TRUE
#
#####
###
### source default values
###
#####
#
if ( -f .hsdefaults ) then
    source .hsdefaults
else
    echo "cannot find your .hsdefaults file \!"
    exit
endif
#
if ( -f .constants ) then
    source .constants
else
    echo "cannot find your .constants file \!"
    exit
endif
#
if ( -f .projectdefaults ) then
    source .projectdefaults
else
    echo "cannot find your .projectdefaults file \!"
    echo "using default values\!"
    set ship      = "RV SONNE"
    set cruise    = "SO-xyz"
    set project   = "PROJECT"
    set institute = "IFM-GEOMAR"
    set operator  = "WW"
endif
#
#####
###
### choose what your script should do:
### processing steps...
### =====
### activate by uncommenting

```

```

###
#####
#
#set FIG_CAPT    = 1 # make figure caption
#set CONT_PLOT   = 1 # make contour plot
#set CLIP_MASK   = 1 # masking with psclip - polygon files needed
set IMG_PLOT     = 1 # make grdimage-plot
#set PROF_PLOT   = 1 # plot profile lines
#set NAV_PLOT    = 1 # plot navigation
#set STAT_PLOT   = 1 # plot stations
#set CORL_PLOT   = 1 # plot points/symbols
set CITIES       = 1 # plot and annotate cities
#set SCALE_BAR   = 1 # include scale bar
set COL_SCALE    = 1 # include color scale
#set TEXT_BOX    = 1 # plot a text box
#set STAMP       = 1 # print GMT timestamp with add. info
#set PRINT_PLOT  = 1 # print <PRINT_PLOT> copies of the plot
#
#####
###
### check / change these parameters and switches
###
#####
#
# required for any plot:
#
set B_STRING     = f10ma1/f10ma1ESwn
set X_OFFS       = 3.0 # lower left corner ...
set Y_OFFS       = 3.9 # ... of plot
set COAST_RES    = f    # choose one of f[ull], h[igh], l[ow], c[rude]
#
# required for figure caption:
#
set CAPT_TEXT    = " - RV METEOR Cruise M67-1 Cruise Track"
#
# required for CONT- and IMG-PLOT
#
set GRID         = ${F_NAME}_150_150_z.grd
set BGRID        = topo_37-32_200_200_z.grd
set CONT_INT     = 1000
set ANT_INT      = 5000f4
set CONT_COL     = ${BLACK}
set ANT_COL      = ${RED}
set CONT_MIN     = -10000 # minimum and ...
set CONT_MAX     = -10    # ... maximum depth to be contoured
#
# required for IMG-PLOT
#
set CPT_FILE     = tipteq_z.cpt # color scale file
# if you do not want illumination, comment the next line out!
set ILU         = 300
#
if ( ${?CLIP_MASK} ) then
#
# required if CONT- or IMG-PLOT has to be clipped
#
set CLIP_DIR     = CLIPS
set CLIPS        = clip_
#
endif
#

```

```

# required for optional profile-, nav-, station- ... plots:
# according file names with data
#
set PROF_FILE = survey_lines.xy
set NAV_FILE  = ../../margin_37-32/chileplanung_final.xy
set STAT_FILE = /data1/Chile/VidalGormaz/stations/mudvolcano.xy
set STAT_TXT  = ../stations/cities.txt
set CORL_FILE1 = box_1.xy
set CORL_FILE2 = box_2.xy
set NAME_FILE  = ../../stations/cities
#
# required if SCALE_BAR included
#
set SCALE_X_POS = -74.00 # position of ...
set SCALE_Y_POS = -33.90 # ... km scale bar
set REF_LAT     = -33.0  # reference latitude
set SCALE_LEN  = 60     # length of scale bar in km
#
# required if TEXT_BLOCK
#
set TITLE      = "MULTIBEAM Survey"
set TB_X = 0.1 # lower left corner ...
set TB_Y = 0.1 # ... of text block
#
# required if print wanted
#
set PRINTER    = qms2425-a4-8d_213
#
#####
###
### do not change these statements
###
#####
#
set CMD = $0
set FIG_NR = `echo $CMD | sed 's%.\./fig_%g' | sed 's%.cmd%g'`
set PS_FILE = "fig_${FIG_NR}.ps"
set GRID_SIZE = `grdinfo ${GRID} | grep x_inc | awk '{print $7}'`
#if ( ${?CITIES} ) then
# #
# # plot and annotate cities
# set NAME_FILE = `./plot_cities.cmd`
#endif
#
#####
#
# now start plotting ...
#
# =====
#
if ( ${?FIG_CAPT} ) then
#
echo figure caption...
pstext -Jx0.1 -R0/90/0/90 -G${BLACK} \
                                           -K -V << END > ${PS_FILE}

10 2 12 0 5 1 Figure ${FIG_NR}:
END
pstext -Jx -R -G${BLACK} \
                                           -O -K -V << END >> ${PS_FILE}

40 2 12 0 4 1 ${CAPT_TEXT}
END

```



```

#
  echo Running grdimage without illumination ...
  grdimage ${GRID} -Jm${SCALE_A4} -R${REGION} \
    -C${CPT_FILE} \
    -O -K -V >> ${PS_FILE}

  endif
#
endif
#
# =====
#
if ( ${?CONT_PLOT} ) then
#
  # Make contour map
  echo Running grdcontour...
  grdcontour ${GRID} -Jm${SCALE_A4} \
    -R${REGION} -C${CONT_INT} -A${ANT_INT} -Q20 \
    -T -Wa1/${ANT_COL} -Wc0/${CONT_COL} \
    -L${CONT_MIN}/${CONT_MAX} \
    -O -K -V >> ${PS_FILE}

#
endif
#
# =====
#
if ( ${?CLIP_MASK} ) then
#
  # De-activate clipping path...
  echo Running psclip...
  psclip -C
  -O -K -V >> ${PS_FILE}
#
endif
#
# =====
#
if ( ${?PROF_PLOT} ) then
#
  # Plot profile lines...
#
  echo plot track lines ...
  psxy ${PROF_FILE} -R -Jm -M \
    -W3 -O -K -V >> ${PS_FILE}
#
endif
#
# =====
#
if ( ${?NAV_PLOT} ) then
#
#
# Plot DVS navigation on top...
#
  psxy ${NAV_FILE} -R -Jm \
    -W2/${RED} -O -K -V >> ${PS_FILE}
#
#
endif
#
# =====
#

```

```

if ( ${?STAT_PLOT} ) then
#
# Plot stations...
#
    echo plot stations ...
    #
    set TITLE = "station positions"
    #

    psxy ${STAT_FILE} -R -Jm -G${RED} \
        -W1/${BLACK} -Sc0.2 -O -K -V >> ${PS_FILE}
#
#   pstext ${STAT_TXT} -Jm -R -G${BLACK} \
#           -O -K -V >> ${PS_FILE}
#
endif
#
# =====
#
echo plot land topography ...
#
pscoast -R${PLOT_AREA} -Jm -D${COAST_RES} \
        -B${B_STRING} -Gc -O -K -V >> ${PS_FILE}
#
# Make grdimage plot with illumination
#
# Get shading array
#
    if !( -f ilum${ILU}_${BGRID} ) then
        echo Getting shading array...
        echo Running grdgradient...
        grdgradient ${BGRID} -A${ILU} -G${F_NAME}.grad -N -M
        echo Running grdhisteq...
        grdhisteq ${F_NAME}.grad -G${F_NAME}.eq -N
        echo Running grdmath...
        grdmath ${F_NAME}.eq 0.35 MUL = ilum${ILU}_${BGRID}
        echo Deleting surplus files...
        /bin/rm -f ${F_NAME}.grad ${F_NAME}.eq
    endif
#
    echo Running grdimage with illumination ...
    grdimage ${BGRID} -Jm -R${REGION} \
        -C${CPT_FILE} -Iilum${ILU}_${BGRID} \
        -O -K -V >> ${PS_FILE}
#
pscoast -Q -O -K -V >> ${PS_FILE}
#
pscoast -R${PLOT_AREA} -Jm -D${COAST_RES} \
        -W1/${BLUE} \
        -Ia/2,${BLUE},solid -N1/2/255/0/0:0t15_10_2_10:0 \
        -Lf${SCALE_X_POS}/${SCALE_Y_POS}/${REF_LAT}/${SCALE_LEN} \
        -B${B_STRING} -O -K -V >> ${PS_FILE}
#
# =====
#
if ( ${?CITIES} ) then
#
# include geographic names...
#
    echo "include geographic names ..."

```

```

#
psxy ${NAME_FILE}.xy      \
    -R                    \
    -Jm                    \
    -Ss0.2 -G${BLACK}      -O -K -V >> ${PS_FILE}
#
# /bin/rm ${NAME_FILE}.xy
#

pstext ${NAME_FILE}.txt  \
    -R                    \
    -Jm                    \
    -W${WHITE} -G${BLACK}  -O -K -V >> ${PS_FILE}
#
# /bin/rm ${NAME_FILE}.txt
#
endif
#
# =====
#
if ( ${?CORL_PLOT} ) then
#
# Plot points of interest...
#
echo plot points ...
#
set TITLE = "points of interest"
#
psxy ${CORL_FILE1} -R -Jm  \
    -W3/${RED}              -O -K -V >> ${PS_FILE}
psxy ${CORL_FILE2} -R -Jm  \
    -W3/${RED}              -O -K -V >> ${PS_FILE}
#
endif
#
# =====
#
if ( ${?COL_SCALE} ) then
#
gmtset ANOT_FONT_SIZE      6
gmtset LABEL_FONT_SIZE    8
#
psscale -D0.2c/4.0c/7.5c/0.5c -B:meter: -C${CPT_FILE} -L \
    -O -K -V >> ${PS_FILE}
#
gmtset ANOT_FONT_SIZE     10
gmtset LABEL_FONT_SIZE    10
#
endif
#
# =====
#
# Plot text box ...
#
if ( ${?TEXT_BOX} ) then
echo plot textbox...
#
pstext -Jx0.1 -R0/90/0/40 -G${BLACK} \
    -X${TB_X} -Y${TB_Y} \

```

```

-C0.001 -W -O -K -V << END >> ${PS_FILE}
1.00 7.0 10 0 31 1 ${ship} ${cruise}
1.00 5.5 8 0 0 1 ${F_NAME}
1.00 4.0 8 0 0 1 ${project} ${TITLE}
1.00 2.5 8 0 0 1 Mercator WGS84 ${SCALE_A4}
1.00 1.0 8 0 0 1 contour interval ${CONT_INT} m
END
echo textbox done...
#
endif
#
# =====
#
if ( ${?STAMP} ) then
#
pstext -Jm${SCALE_A4} -R${PLOT_AREA} -G${BLACK} \
-U"${CMD} / $institute / produced by $operator" \
-O -V << END >> ${PS_FILE}
END
#
else
#
# =====
#
pstext -Jm${SCALE_A4} -R${PLOT_AREA} -G${BLACK} \
-O -V << END >> ${PS_FILE}
END
#
endif
#
# =====
#
if ( ${?PRINT_PLOT} ) then
#
# Print one copy...
#
while ($PRINT_PLOT)
#
@ PRINT_PLOT --
echo printing a copy on ${PRINTER} ...
lp -d${PRINTER} ${PS_FILE}
sleep 10
end
#
endif
#
# All done
echo All done...

```

A-4.1: ancillary files: .hsdefaults

```
set F_NAME = Area_1
set REGION = -74.70/-71.00/-34.00/-32.00
set REGION_GRID = -74.70/-71.00/-34.00/-32.00
set PLOT_AREA = -74.70/-71.00/-34.00/-32.00
set SCALE_A4 = -73.0/-34.0/1:1500000
set SCALE_A3 =
set SCALE_A0 = -73.0/-34.0/1:300000
```

A-4.2: ancillary files: .projectdefaults

```
set ship = "RV METEOR"
set cruise = "M67-1"
set project = "CHILE-MARGIN-SURVEY"
set institute = "IFM-GEOMAR"
set operator = "WW"
```

A-4.3: ancillary files: .constants

```
set WHITE = 255/255/255
set BLACK = 0/0/0
set RED = 255/0/0
set GREEN = 0/255/0
set BLUE = 0/0/255
set GREY = 150/150/150
set LIGHTGREY = 200/200/200
set DARKGREY = 120/120/120
set LAND_COL = 200/150/100
```

Appendix 15.5: Magnetotelluric Instrumentation

Station Nr.	Dev. ID	Time and koordinaten		Depth (m)	Releaser Codes Release (Time release)	Elektroden Paar 1		Elektroden Paar 2						
		UTC-Date	UTC			Latitude	Longitude	1 (COM)	2	Udiff (mV)	Dist. (m)	4	Udiff (mV)	Dist. (m)
MT305	27	15/03/08	03:46	34°46'21,27" S	72°30'40,77" W	549	430326 (10.04.08 20:00)	0709014	0709024	0.0	10.15	0709008	-0.1	10.14
MT307	30	15/03/08	05:42	34°43'34,20" S	72°38'44,33" W	799	131415 (10.04.08 18:00)	0709023	0709022	0.1	10.19	0704008	0.1	10.15
MT309	25	18/03/08	12:08	34°41'04,40" S	72°46'14,98" W	1124	431501 (10.04.08 16:30)	0709021	0709006	0	10.17	0709009	0.2	10.21
MT311	29	12/03/08	04:40	34°38'23,32" S	72°54'12,74" W	2622	145101 (10.04.08 16:00)	0707018	0704061	0	10.23	0707008	0	10.19
MT314	31	15/03/08	10:27	34°34'26,01" S	73°05'56,22" W	2925	133477 (10.04.08 17:00)	0704001	0704004	-0.1	10.24	0707024	-1.4	10.22
MT317	24	15/03/08	14:21	34°30'27,90" S	73°17'40,95" W	4254	435656 (10.04.08 12:00)	0707012	0707002	0	10.2	0602009	-0.2	10.25
MT320	26	12/03/08	10:55	34°26'31,02" S	73°29'27,29" W	5264	442144 (10.04.08 10:00)	0707007	0707006	-0.1	10.43	0707016	-0.1	10.08
MT324	32	12/03/08	13:09	34°21'09,45" S	73°45'10,12" W	4535	442205 (10.04.08 08:00)	0707022	0707010	0	10.36	0704006	0	10.03
MT329	33	12/03/08	16:35	34°14'31,14" S	74°04'49,63" W	4166	435445 (10.04.08 06:00)	0707012	0707002	0	10.45	0707014	-0.1	10.05

Appendix 15.6.1: Core positions

Longitude	Latitude	Name	water depth	geographic position	Length m	Deg	min	Deg	min
-73,664833	-35,601833	GC01	-2889	Reference above headscarp	6,72	73	39,8900	W	35 36,1100
-73,676033	-35,602360	GC02	-3398	Slide plane upper part	0,15	73	40,5620	W	35 36,1416
-73,688130	-35,602070	GC03	-3916	Slide plane middle part	0,15	73	41,2878	W	35 36,1242
-74,530465	-34,618133	GC04	-4210	Hemipelagic cover of NazcaPlate	5,54	74	31,8279	W	34 37,0880
-74,221500	-34,693000	GC05	-4156	Hemipelagic cover of NazcaPlate	7,495	74	13,2900	W	34 41,5800
-74,086167	-34,243167	GC06	-4163	Hemipelagic cover of NazcaPlate	5,17	74	5,1700	W	34 14,5900
-73,368972	-35,511647	GC07	-1357	Reference above headscarp	0,15	73	22,1383	W	35 30,6988
-73,381862	-35,521727	GC08	-1244	Slide plane middle part	0,05	73	22,9117	W	35 31,3036
-73,344153	-35,550998	GC09	-1600	Distal end of slump	1,535	73	20,6492	W	35 33,0599
-73,919593	-35,554547	GC10	-5054	Distal end of slump	0,3	73	55,1756	W	35 33,2728
-73,908513	-35,550845	GC11	-5056	Distal end of slump	5,16	73	54,5108	W	35 33,0507
-73,734772	-35,586555	GC12	-4473	Summit of slump block	2,03	73	44,0863	W	35 35,1933
-73,716817	-35,631105	GC13	-3927	Slide plane middle part	0,15	73	43,0090	W	35 37,8663
				sum:	34,6				

Appendix 15.6.2: Core protocol

JC23b-GC01 Slump at the lower continental slope

Geographical description: Reference core upslope of fault headscarp
General Comment: very sticky and firm mud in the core catcher

Water Depth: 2889 m **Date:** 03.04.08 **Max. tension:** 5,9t
Cable Length: 2894 m **Time (UTC):** 13:37:00 **Pull-out Speed:** 5m/min
Echosounder Depth: 2893 m

	Decimal Degrees	Degree	Minute
Longitude	-73,664833	73	39,8900 W
Latitude	-35,601833	35	36,1100 S

Segments

Start cm	End cm	Label/Lenght/Comment
0	78,7	G (78,7cm)
78,7	178,7	F (100 cm)
178,7	273,2	E (94,5 cm)
273,2	374,2	D (101 cm)
374,2	474,2	C (100 cm)
474,2	572,7	B (98,5 cm)
572,7	672	A (99,3cm)
		core catcher

JC23b-GC02 Slump at the lower continental slope

Geographical description: Upper headscarp, slope gradient ~ 22°
General Comment: Only core catcher material, core possibly penetrated just a few cm silty material, very dry and hard, Thin (1-2 cm) layer of mud on top

Water Depth: 3398 m **Date:** 04.04.08 **Max. tension:** 5,25t
Cable Length: 3380 m **Time (UTC):** 01:10:00 **Pull-out Speed:** 4m/min
Echosounder Depth: 3375 m

	Decimal Degrees	Degree	Minute
Longitude	-73,676033	73	40,5620 W
Latitude	-35,602367	35	36,1420 S

Segments

Start cm	End cm	Label/Lenght/Comment
		core catcher, upper part ~ 7cm
		core catcher, lower part ~ 7cm

JC23b-GC03 Slump at the lower continental slope

Geographical description: Central headscarp, slope gradient ~ 24°
General Comment: Sediment only in the core catcher: very hard, gray and almost dry clay had to be removed from the core tip with hammer and chisel (!)

Water Depth: 3916 m **Date:** 04.04.08 **Max. tension:** 5,19t
Cable Length: 3910 m **Time (UTC):** 03:53:00 **Pull-out Speed:** 4m/min
Echosounder Depth: 3900 m

	Decimal Degrees	Degree	Minute
Longitude	-73,688130	73	41,2878 W
Latitude	-35,602070	35	36,1242 S

Segments

Start cm	End cm	Label/Lenght/Comment
		Dry hard clay in the core cutter (~15cm)

Appendix 15.6.2: Core protocol

JC23b-GC04		Nazca Plate	
Geographical description:	Hemipelagic cover of Nazca Plate		
General Comment:	mudstains on the outer core up to the headweight.		
Water Depth:	4210 m	Date:	04.04.08
Cable Length:	4242 m	Time (UTC):	21:10:00
Echosounder Depth:	4232 m	Max. tension:	6,73t
		Pull-out Speed:	10m/min
	Decimal Degrees	Degree	Minute
Longitude	-74,530465	74	31,8279 W
Latitude	-34,618133	34	37,0880 S
Segments			
Start cm	End cm	Label/Lenght/Comment	
0	51	51 cm	
51	152,5	101,5 cm	
152,5	252,5	100 cm	
252,5	353,5	101 cm	
353,5	454	100,5 cm	
454	545	100 cm	

JC23b-GC05		Nazca Plate	
Geographical description:	Hemipelagic cover of Nazca Plate		
General Comment:			
Water Depth:	4156 m	Date:	04.04.08
Cable Length:	4164 m	Time (UTC):	22:36:00
Echosounder Depth:	4152 m	Max. tension:	6,59t
		Pull-out Speed:	10m/min
	Decimal Degrees	Degree	Minute
Longitude	-74,221500	74	13,2900 W
Latitude	-34,693000	34	41,5800 S
Segments			
Start cm	End cm	Label/Lenght/Comment	
0	46	H:46 cm Segment not completely full	
46	146,5	G:100,5 cm	
146,5	246,5	F:100,0 cm	
246,5	347,5	E:101,0 cm	
347,5	448	D:100,5 cm	
448	548,5	C:100,5 cm	
548,5	649	B:100,5 cm	
649	749,5	A:100,5 cm	

Appendix 15.6.2: Core protocol

JC23b-GC06 Nazca Plate

Geographical description: Hemipelagic cover of Nazca Plate

General Comment:

Water Depth: 4163 m **Date:** 05.04.08 **Max. tension:** 6,8t
Cable Length: 4163 m **Time (UTC):** 22:50:00 **Pull-out Speed:** 10m/min
Echosounder Depth: 4160 m

	Decimal Degrees	Degree	Minute
Longitude	-74,086167	74	5,1700 W
Latitude	-34,243167	34	14,5900 S

Segments

Start cm	End cm	Label/Lenght/Comment
0	21,5	21,5 cm not completely filled
21,5	117	95,5 cm
117	217	100 cm
217	317	100cm
317	417,5	100,5cm
417,5	517,5	100 cm

JC23b-GC07 Slump on the middle slope

Geographical description: Slide directed landward, reference site to the side of the slump

General Comment: Core probably toppled over
very hard clay in the cutter

Water Depth: 1357 m **Date:** 11.04.08 **Max. tension:** 2,61t
Cable Length: 1367 m **Time (UTC):** 02:35:00 **Pull-out Speed:** 10m/min
Echosounder Depth: 1322 m

	Decimal Degrees	Degree	Minute
Longitude	-73,368972	73	22,1383 W
Latitude	-35,511647	35	30,6988 S

Segments

Start cm	End cm	Label/Lenght/Comment
0	15	cutter

JC23b-GC08 Slump on the middle slope

Geographical description: Headscarp of the slump

General Comment: core probably toppled over, core bent

Water Depth: 1244 m **Date:** 11.04.08 **Max. tension:** 2,85t
Cable Length: 1249 m **Time (UTC):** 03:30:00 **Pull-out Speed:** 10m/min
Echosounder Depth: 1244 m

	Decimal Degrees	Degree	Minute
Longitude	-73,381862	73	22,9117 W
Latitude	-35,521727	35	31,3036 S

Segments

Start cm	End cm	Label/Lenght/Comment
0	60	+ ca. 5 cm of fill

Appendix 15.6.2: Core protocol

JC23b-GC09		Slump on the middle slope			
Geographical description:	Distal toe of the slump				
General Comment:	Core bent, probably toppled over Core catcher and cutter empty				
Water Depth:	1600 m	Date:	11.04.08	Max. tension:	3,48t
Cable Length:	1587 m	Time (UTC):	04:10:00	Pull-out Speed:	10m/min
Echosounder Depth:	1600 m				

	Decimal Degrees	Degree	Minute
Longitude	-73,344153	73	20,6492 W
Latitude	-35,550998	35	33,0599 S

Segments

Start cm	End cm	Label/Lenght/Comment
0	55,5	B: 55,5 cm
55,5	153,5	A: 98,0 cm

JC23b-GC10		Slump at the lower continental slope			
Geographical description:	Distal (westernmost) end of slump, west of axial channel				
General Comment:	Winch tension drop in two peaks: core probably toppled over core bent, upper 30 cm soft mud. Hit a sand layer?				
Water Depth:	5054 m	Date:	15.04.08	Max. tension:	6,72t
Cable Length:	5073 m	Time (UTC):	16:37:00	Pull-out Speed:	5m/min
Echosounder Depth:	5060 m				

	Decimal Degrees	Degree	Minute
Longitude	-73,919593	73	55,1756 W
Latitude	-35,554547	35	33,2728 S

Segments

Start cm	End cm	Label/Lenght/Comment
0	30	A: 30,0 cm

JC23b-GC11		Slump at the lower continental slope			
Geographical description:	Distal end of slump, west of the axial channel				
General Comment:	core catcher and core cutter filled				
Water Depth:	5056 m	Date:	15.04.08	Max. tension:	6,98t
Cable Length:	5064 m	Time (UTC):	21:00:00	Pull-out Speed:	10m/min
Echosounder Depth:	5020 m				

	Decimal Degrees	Degree	Minute
Longitude	-73,908513	73	54,5108 W
Latitude	-35,550845	35	33,0507 S

Segments

Start cm	End cm	Label/Lenght/Comment
0	31	not filled to 3 cm, 31 cm length
31	114	not filled to 4 cm, 83 cm length
114	214,5	100,5 cm
214,5	315	100,5 cm
315	415,5	100,5 cm
415,5	516	100,5 cm

Appendix 15.6.2: Core protocol

JC23b-GC12		Slump at the lower continental slope			
Geographical description:	summit of easternmost slump block				
General Comment:	Core bent, core catcher contains 20 cm. Core cutter contains poorly sorted, very coarse, stiff material (volc. Ashes?). Penetration was probably stopped by this bed				
Water Depth:	4473 m	Date:	16.04.08	Max. tension:	5,92t
Cable Length:	4469 m	Time (UTC):	02:01:00	Pull-out Speed:	10m/min
Echosounder Depth:	4451 m				

	Decimal Degrees	Degree	Minute
Longitude	-73,734772	73	44,0863 W
Latitude	-35,586555	35	35,1933 S

Segments

Start cm	End cm	Label/Lenght/Comment
0	30	liner deformed, original length 45 cm
30	64	34 cm
64	126	62 cm
126	203	77 cm

JC23b-GC13		Slump at the lower continental slope			
Geographical description:	Central headscarp				
General Comment:	core cutter filled with hard, dry clay no further material				
Water Depth:	3920 m	Date:	16.04.08	Max. tension:	4,9t
Cable Length:	3929 m	Time (UTC):	06:07:00	Pull-out Speed:	10m/min
Echosounder Depth:	3500 m	echosounder missvalue			

	Decimal Degrees	Degree	Minute
Longitude	-73,7168	73	43,0090 W
Latitude	-35,6311	35	37,8663 S

Segments

Start cm	End cm	Label/Lenght/Comment
0	15	

Appendix 15.7: Marine Mammal Report JC23

Date	Time (UTC)	Position	Remark	Airgun Active
08.03.2008	17:36	34°54,5'S / 73°42,0'W	3-4 whales heading north	y
09.03.2008	10:16		3 seals observed once	y
10.03.2008	18:20	34°55'S / 73°37'W	2 seals	n
10.03.2008	21:15	34°51'S / 73°46'W	group of whales, 0.5 nm away	n
11.03.2008	15:30		1 whale	n
11.03.2008	19:05	34°59,25'S / 72°43,73'W	seal	n
14.03.2008	11:30	34°41,67'S / 72°44,60'W	dolphin school (25-35 animals)	y
14.03.2008	12:10	34°42,59'S / 72°41,89'W	whale, approx. 1.5 nm SE of ship	y
14.03.2008	13:07	34°44,25'S / 72°36,97'W	whale	y
14.03.2008	14:45	34°46,88'S / 72°29,15'W	whale approx. 1 km port side, seal or sealion	y
15.03.2008	11:30	34°32,74'S / 73°10,44'W	approx. 15 whales, 2 or 3 seals	n
19.03.2008	18:00	34°32,2'S / 74°02'W	whale	n
22.03.2008	13:50	34°36,04'S / 72°47,05'W	seal	n
22.03.2008	15:50	34°21,41'S / 72°33,13'W	seal	n
22.03.2008	19:20	34°16,70'S / 72°32,43'W	4-5 seals	n
23.03.2008	14:50	31°10,05'S / 74°17,77'W	several seals	
24.03.2008	19:05-19:25	32°30'S / 762°10'W	1 whale	n
29.03.2008		35°43,07'S / 73°19,03'W	seals, 500 m away, ~10 animals, ~10 min.	
29.03.2008	16:40	35°40,9'S / 73°27,9'W	2-3 seals, 300 m away, ~5 min.	n
30.03.2008	13:15	35°53,56'S / 73°32,2'W	2 whales, 700 m away, ~2 min.	n
30.03.2008	14:04	35°50,43'S / 73°30'W	2 seals, 100 m away, ~3 min.	n
31.03.2008	14:20	35°54'S / 73°31'W	1 whale, 600 m away, ~5 min.	stopped
31.03.2008	21:30	36°03,28'S / 73°38,5'W	5 whales, 1000 m away, ~20 min.	
31.03.2008	22:40	36°05,24'S / 73°40'W	1 whale, 1000 m, ~2 min.	y
01.04.2008	22:40	36°22'S / 73°41'W	1 whale, 1 nm away, ~5 min.	y
06.04.2008	13:30	34°26'S / 73°29'W	5-10 whales, 2 cables away, ~1,5 hrs.	n
06.04.2008	19:30	34°28'S / 73°17'W	1 whale	n
06.04.2008	21:50	34°30'S / 73°17'W	1 whale	n
12.04.2008	20:50	36°17,21'S / 73°40,86'W	5-7 whales	stopped

Appendix 15.8: Timetable

Cruise JC23a

R.R.S. James Cook

Timetable of Events

Start		End		All times Local time	Comment	Indicator	dd hh:mm	hours
Date	Time	Date	Time					
01.03.2008	08:42	02.03.2008	08:12	Arr. Valparaiso anchorage		Anc	0 23:30	23.50
02.03.2008	08:12	02.03.2008	09:18	Anchorage to berth		Pass	0 01:06	1.10
02.03.2008	09:18	03.03.2008	07:42	Mobilisation		Mob	0 22:24	22.40
03.03.2008	07:42	03.03.2008	08:06	Shift ship		Port	0 00:24	0.40
03.03.2008	08:06	03.03.2008	19:18	Mobilisation		Mob	0 11:12	11.20
03.03.2008	19:18	04.03.2008	04:54	Passage towards work area. Add 1 hr for retardation of clocks to GMT-4		Pass	0 10:36	10.60
04.03.2008	04:54	04.03.2008	08:34	Acoustic release tests 34 05.0S 72 55.0W		Art	0 03:40	3.67
04.03.2008	08:34	04.03.2008	11:48	Repositioning		RWP	0 03:14	3.23
04.03.2008	11:48	04.03.2008	12:00	OBS#501 released in 34 30.00S 72 44.94W		OBS	0 00:12	0.20
04.03.2008	12:00	04.03.2008	14:18	Repositioning		RWP	0 02:18	2.30
04.03.2008	14:18	04.03.2008	14:30	OBS#502 released in 34 24.97S 73 04.99W		OBS	0 00:12	0.20
04.03.2008	14:30	04.03.2008	16:36	Repositioning		RWP	0 02:06	2.10
04.03.2008	16:36	04.03.2008	16:48	OBS#503 released in 34 11.97S 73 19.93W		OBS	0 00:12	0.20
04.03.2008	16:48	04.03.2008	18:42	Repositioning		RWP	0 01:54	1.90
04.03.2008	18:42	04.03.2008	19:18	Acoustic release tests in 34 03.90S 73 38.90W		Art	0 00:36	0.60
04.03.2008	19:18	04.03.2008	21:48	Repositioning		RWP	0 02:30	2.50
04.03.2008	21:48	04.03.2008	22:00	OBS#504 released in 35 53.91S 73 05.00W		OBS	0 00:12	0.20
04.03.2008	22:00	05.03.2008	00:12	Repositioning		RWP	0 02:12	2.20
05.03.2008	00:12	05.03.2008	00:24	OBS#329 released in 34 14.60S 74 04.81W		OBS	0 00:12	0.20
05.03.2008	00:24	05.03.2008	02:12	Repositioning		RWP	0 01:48	1.80
05.03.2008	02:12	05.03.2008	02:24	OBS#325 released in 34 19.79S 73 49.08W		OBS	0 00:12	0.20
05.03.2008	02:24	05.03.2008	02:54	Repositioning		RWP	0 00:30	0.50
05.03.2008	02:54	05.03.2008	03:06	OBS#324 released in 34 21.23S 73 45.25W		OBS	0 00:12	0.20
05.03.2008	03:06	05.03.2008	04:48	Repositioning		RWP	0 01:42	1.70
05.03.2008	04:48	05.03.2008	05:00	OBS#320 released in 34 26.46S 73 29.41W		OBS	0 00:12	0.20
05.03.2008	05:00	05.03.2008	05:48	Shifting and securing gear on deck		RWP	0 00:48	0.80
05.03.2008	05:48	05.03.2008	09:36	Repositioning		RWP	0 03:48	3.80
05.03.2008	09:36	05.03.2008	09:48	OBS#601 released in 34 47.00S 72 57.00W		OBS	0 00:12	0.20
05.03.2008	09:48	05.03.2008	11:30	Repositioning		RWP	0 01:42	1.70
05.03.2008	11:30	05.03.2008	11:48	OBS#602 released in 34 42.02S 73 12.17W		OBS	0 00:18	0.30
05.03.2008	11:48	05.03.2008	13:18	Repositioning		RWP	0 01:30	1.50
05.03.2008	13:18	05.03.2008	13:30	OBS#603 released in 34 37.05S 73 29.01W		OBS	0 00:12	0.20
05.03.2008	13:30	05.03.2008	15:24	Repositioning		RWP	0 01:54	1.90
05.03.2008	15:24	05.03.2008	15:36	OBS#604 released in 34 29.97S 73 47.89W		OBS	0 00:12	0.20
05.03.2008	15:36	05.03.2008	16:36	Repositioning		RWP	0 01:00	1.00
05.03.2008	16:36	05.03.2008	16:48	OBS#605 released in 34 24.99S 73 59.97W		OBS	0 00:12	0.20
05.03.2008	16:48	05.03.2008	18:12	Repositioning		RWP	0 01:24	1.40
05.03.2008	18:12	05.03.2008	18:24	OBS#606 released in 34 19.98S 74 15.02W		OBS	0 00:12	0.20
05.03.2008	18:24	05.03.2008	19:06	Shifting & securing gear on deck		RWP	0 00:42	0.70
05.03.2008	19:06	05.03.2008	22:00	Repositioning		RWP	0 02:54	2.90
05.03.2008	22:00	05.03.2008	22:54	OBS#131 released; failed to sink; recovered; extra weight added; re-released in 34 35.49S 74 28.63W		OBS	0 00:54	0.90
05.03.2008	22:54	06.03.2008	02:18	Repositioning		RWP	0 03:24	3.40

Appendix 15.8: Timetable

Cruise JC23a

R.R.S. James Cook

Start		End		All times Local time	Comment	Indicator	dd hh:mm	hours
Date	Time	Date	Time					
06.03.2008	02:18	06.03.2008	02:30	OBS#702 released in 34 45.00S 74 43.18W		OBS	0 00:12	0.20
06.03.2008	03:18	06.03.2008	03:18	Shifting & securing gear on deck whilst v/l remains hove-to in gale force conditions		RWP	0 00:48	0.80
06.03.2008	03:30	06.03.2008	07:21	Repositioning via zig-zag track due to weather conditions		RWP	0 04:03	4.05
06.03.2008	07:21	06.03.2008	08:06	Waiting on site		RWP	0 00:45	0.75
06.03.2008	08:06	06.03.2008	08:12	OBS#228 (for network) released in 34 34.33S 74 10.83W		OBS	0 00:06	0.10
06.03.2008	08:12	06.03.2008	09:18	Repositioning		RWP	0 01:06	1.10
06.03.2008	09:18	06.03.2008	09:30	OBS#127 (for network) released in 34 41.58S 74 13.27W		OBS	0 00:12	0.20
06.03.2008	09:30	06.03.2008	11:06	Repositioning		RWP	0 01:36	1.60
06.03.2008	11:06	06.03.2008	11:18	OBS#226 (for network) released in 34 37.00S 74 02.80W		OBS	0 00:12	0.20
06.03.2008	11:18	06.03.2008	11:48	Waiting on site		RWP	0 00:30	0.50
06.03.2008	11:48	06.03.2008	13:00	Repositioning		RWP	0 01:12	1.20
06.03.2008	13:00	06.03.2008	13:12	OBS#124 (for network) released in 34 46.23S 74 01.53W		OBS	0 00:12	0.20
06.03.2008	13:12	06.03.2008	14:30	Repositioning		RWP	0 01:18	1.30
06.03.2008	14:30	06.03.2008	14:42	OBS#223 (for network) released in 34 40.84S 73 51.18W		OBS	0 00:12	0.20
06.03.2008	14:42	06.03.2008	16:00	Repositioning		RWP	0 01:18	1.30
06.03.2008	16:00	06.03.2008	16:12	OBS#121 (for network) released in 34 50.64S 73 50.19W		OBS	0 00:12	0.20
06.03.2008	16:12	06.03.2008	18:42	Repositioning		RWP	0 02:30	2.50
06.03.2008	18:42	06.03.2008	18:54	OBS#701 released in 35 10.01S 73 52.98W		OBS	0 00:12	0.20
06.03.2008	18:54	06.03.2008	21:48	Repositioning		RWP	0 02:54	2.90
06.03.2008	21:48	06.03.2008	22:00	OBS#221 (for network) released in 34 43.40S 73 43.16W		OBS	0 00:12	0.20
06.03.2008	22:00	07.03.2008	00:48	Repositioning		RWP	0 02:48	2.80
07.03.2008	00:48	07.03.2008	01:00	OBS#113 released in 35 02.62S 73 19.57W		OBS	0 00:12	0.20
07.03.2008	01:00	07.03.2008	01:24	Repositioning		RWP	0 00:24	0.40
07.03.2008	01:24	07.03.2008	01:36	OBS#112 released in 35 04.22S 73 15.67W		OBS	0 00:12	0.20
07.03.2008	01:36	07.03.2008	02:00	Repositioning		RWP	0 00:24	0.40
07.03.2008	02:00	07.03.2008	02:12	OBS#111 released in 35 05.66S 73 11.94W		OBS	0 00:12	0.20
07.03.2008	02:12	07.03.2008	02:36	Repositioning		RWP	0 00:24	0.40
07.03.2008	02:36	07.03.2008	02:42	OBS#110 released in 35 07.11S 73 08.15W		OBS	0 00:06	0.10
07.03.2008	02:42	07.03.2008	03:06	Preparation work		RWP	0 00:24	0.40
07.03.2008	03:06	07.03.2008	03:28	Repositioning		RWP	0 00:22	0.37
07.03.2008	03:28	07.03.2008	03:40	OBS#109 released in 35 08.60S 73 04.35W		OBS	0 00:12	0.20
07.03.2008	03:40	07.03.2008	04:00	Repositioning		RWP	0 00:20	0.33
07.03.2008	04:00	07.03.2008	04:12	OBS#108 released in 35 10.05S 73 00.58W		OBS	0 00:12	0.20
07.03.2008	04:12	07.03.2008	04:42	Repositioning		RWP	0 00:30	0.50
07.03.2008	04:42	07.03.2008	04:54	OBS#107 released in 35 11.53S 72 56.86W		OBS	0 00:12	0.20
07.03.2008	04:54	07.03.2008	05:30	Repositioning		RWP	0 00:36	0.60
07.03.2008	05:30	07.03.2008	05:42	OBS#106 released in 35 13.00S 72 53.06W		OBS	0 00:12	0.20
07.03.2008	05:42	07.03.2008	06:09	Repositioning		RWP	0 00:27	0.45
07.03.2008	06:09	07.03.2008	06:21	OBS#105 released in 35 14.52S 72 49.03W		OBS	0 00:12	0.20
07.03.2008	06:21	07.03.2008	06:58	Repositioning		RWP	0 00:37	0.62
07.03.2008	06:58	07.03.2008	07:10	OBS#104 released in 35 16.07S 72 45.16W		OBS	0 00:12	0.20
07.03.2008	07:10	07.03.2008	07:49	Repositioning		RWP	0 00:39	0.65

Timetable of Events

Appendix 15.8: Timetable

Cruise JC23a

R.R.S. James Cook

Start		End		All times Local time	Comment	Indicator	dd hh:mm	hours
Date	Time	Date	Time					
07.03.2008	07:49	07.03.2008	08:01	OBS#103 released in 35 17.57S 72 41.35W		OBS	0 00:12	0.20
07.03.2008	08:01	07.03.2008	08:38	Repositioning		RWP	0 00:37	0.62
07.03.2008	08:38	07.03.2008	08:50	OBS#102 released in 35 19.06S 72 37.54W		OBS	0 00:12	0.20
07.03.2008	08:50	07.03.2008	09:30	V/I aborting line due to inshore concentrations of fishing craft		RWP	0 00:40	0.67
07.03.2008	09:30	07.03.2008	14:12	Repositioning to continue OBS deployments, line#1		RWP	0 04:42	4.70
07.03.2008	14:12	07.03.2008	14:24	OBS#114 released in 35 01.12S 73 23.41W		OBS	0 00:12	0.20
07.03.2008	14:24	07.03.2008	15:09	Repositioning		RWP	0 00:45	0.75
07.03.2008	15:09	07.03.2008	15:21	OBS#115 released in 34 59.57S 73 27.39W		OBS	0 00:12	0.20
07.03.2008	15:21	07.03.2008	15:48	Repositioning		RWP	0 00:27	0.45
07.03.2008	15:48	07.03.2008	16:00	OBS#116 released in 34 58.09S 73 31.16W		OBS	0 00:12	0.20
07.03.2008	16:00	07.03.2008	16:31	Repositioning		RWP	0 00:31	0.52
07.03.2008	16:31	07.03.2008	16:43	OBS#117 released in 34 56.55S 73 35.19W		OBS	0 00:12	0.20
07.03.2008	16:43	07.03.2008	17:14	Repositioning		RWP	0 00:31	0.52
07.03.2008	17:14	07.03.2008	17:26	OBS#118 released in 34 55.00S 73 39.05W		OBS	0 00:12	0.20
07.03.2008	17:26	07.03.2008	17:48	Repositioning		RWP	0 00:22	0.37
07.03.2008	17:48	07.03.2008	18:00	OBS#119 released in 34 53.59S 73 42.69W		OBS	0 00:12	0.20
07.03.2008	18:00	07.03.2008	18:25	Repositioning		RWP	0 00:25	0.42
07.03.2008	18:25	07.03.2008	18:37	OBS#120 released in 34 52.08S 73 46.50W		OBS	0 00:12	0.20
07.03.2008	18:37	07.03.2008	19:22	Repositioning		RWP	0 00:45	0.75
07.03.2008	19:22	07.03.2008	19:34	OBS#122 released in 34 49.16S 73 54.09W		OBS	0 00:12	0.20
07.03.2008	19:34	07.03.2008	20:02	Repositioning		RWP	0 00:28	0.47
07.03.2008	20:02	07.03.2008	20:14	OBS#123 released in 34 47.74S 73 57.87W		OBS	0 00:12	0.20
07.03.2008	20:14	07.03.2008	21:01	Repositioning		RWP	0 00:47	0.78
07.03.2008	21:01	07.03.2008	21:13	OBS#125 released in 34 44.68S 74 05.52W		OBS	0 00:12	0.20
07.03.2008	21:13	07.03.2008	21:37	Repositioning		RWP	0 00:24	0.40
07.03.2008	21:37	07.03.2008	21:49	OBS#126 released in 34 43.16S 74 09.34W		OBS	0 00:12	0.20
07.03.2008	21:49	07.03.2008	22:31	Repositioning		RWP	0 00:42	0.70
07.03.2008	22:31	07.03.2008	22:43	OBS#128 released in 34 40.06S 74 17.09W		OBS	0 00:12	0.20
07.03.2008	22:43	07.03.2008	23:28	Repositioning		RWP	0 00:45	0.75
07.03.2008	23:28	07.03.2008	23:40	OBS#130 released in 34 37.77S 74 22.87W		OBS	0 00:12	0.20
07.03.2008	23:40	08.03.2008	06:36	Swath Survey 34 37.8S 74 23.0W to 34 40.8S 74 21.9W to 34 22.5S 75 00.0W		Swath	0 06:56	6.93
08.03.2008	06:36	08.03.2008	07:18	Preparing for air gun deployment		RWP	0 00:42	0.70
08.03.2008	07:18	08.03.2008	08:45	Streaming 4 off air gun arrays & magnetometer; to 34 25.3S 74 53.3W		AG	0 01:27	1.45
08.03.2008	08:45	08.03.2008	10:42	2x single air guns & streamer deployed; all guns firing; to 34 28.7S 74 45.1W		AG	0 01:57	1.95
08.03.2008	10:42	08.03.2008	16:30	Single air guns off/on line at var times; buoyancy off gun 9 lost @ 1154 hrs in 34 30.7S 74 40.3W; to 34 39.0S 74 19.8W		AG	0 05:48	5.80
08.03.2008	16:30	08.03.2008	16:50	Firing stopped due to sighting of seals; second loss of buoyancy from single gun; to 34 39.6S 74 18.3W		RWP	0 00:20	0.33
08.03.2008	16:50	08.03.2008	17:48	All guns back on line via soft start; port inner beam retained inboard due to streaming problems with all gun arrays dep		AG	0 00:58	0.97
08.03.2008	17:48	08.03.2008	23:59	Seismic line#1 continues; 34 52.0S 73 46.7W		AG	0 06:11	6.18
08.03.2008	23:59	09.03.2008	07:24	Firing continues overnight; gun#8 off & recovered due disconnection from main tow wire; to 35 04.9S 73 13.9W		AG	0 07:25	7.42
09.03.2008	07:24	09.03.2008	09:06	Gum#8 redeployed & online; to 35 07.5S 73 07.1W		AG	0 01:42	1.70
09.03.2008	09:06	09.03.2008	15:00	Various guns off line @ intervals for maintenance; to 35 17.9S 72 40.5W		AG	0 05:54	5.90
09.03.2008	15:00	09.03.2008	15:40	Single guns inboard; magnetometer & streamer recovered; v/l reaches EoL#1 @ 35 19.0S 72 37.6W		AG	0 00:40	0.67

Appendix 15.8: Timetable

Cruise JC23a

R.R.S. James Cook

Timetable of Events

Start		End		All times Local time	Comment	Indicator	dd hh:mm	hours
Date	Time	Date	Time					
09.03.2008	15:40	09.03.2008	17:21	Repositioning to start of 10' line parallel with coast; down to 3 guns then back up to 8 for Sol.; 80m water depth	RWP	0 01:41	1.68	
09.03.2008	17:21	09.03.2008	19:21	35 23.4S 72 40.7W to 35 15.1S 72 34.8W; end transect to line#1 @ 5 knots	AG	0 02:00	2.00	
09.03.2008	19:21	09.03.2008	20:52	Recovering air gun arrays	AG	0 01:31	1.52	
09.03.2008	20:52	09.03.2008	21:55	Securing deck & repositioning for commencement of OBS recoveries, line#1	RWP	0 01:03	1.05	
09.03.2008	21:55	09.03.2008	22:26	OBS#102 recovered; 35 18.8S 73 37.5W	OBS	0 00:31	0.52	
09.03.2008	22:26	09.03.2008	23:00	Repositioning	RWP	0 00:34	0.57	
09.03.2008	23:00	09.03.2008	23:25	OBS#103 recovered; 35 17.6S 72 41.3W	OBS	0 00:25	0.42	
09.03.2008	23:25	10.03.2008	00:06	Repositioning	RWP	0 00:41	0.68	
10.03.2008	00:06	10.03.2008	00:36	OBS#104 recovered; 35 16.0S 72 45.1W	OBS	0 00:30	0.50	
10.03.2008	00:36	10.03.2008	01:23	Repositioning & interrogating OBS	RWP	0 00:47	0.78	
10.03.2008	01:23	10.03.2008	01:53	OBS#105 recovered; 35 14.5S 72 48.9W	OBS	0 00:30	0.50	
10.03.2008	01:53	10.03.2008	02:34	Repositioning	RWP	0 00:41	0.68	
10.03.2008	02:34	10.03.2008	03:04	OBS#106 recovered; 35 13.1S 72 53.0W	OBS	0 00:30	0.50	
10.03.2008	03:04	10.03.2008	03:34	Repositioning	RWP	0 00:30	0.50	
10.03.2008	03:34	10.03.2008	03:56	OBS#107 recovered; 35 11.6S 72 56.8W	OBS	0 00:22	0.37	
10.03.2008	03:56	10.03.2008	05:17	Repositioning & interrogating OBS	RWP	0 01:21	1.35	
10.03.2008	05:17	10.03.2008	05:37	OBS#108 recovered; 35 10.1S 73 00.6W	OBS	0 00:20	0.33	
10.03.2008	05:37	10.03.2008	06:34	Repositioning & interrogating OBS	RWP	0 00:57	0.95	
10.03.2008	06:34	10.03.2008	06:47	OBS#109 recovered; 35 08.7S 73 04.4W	OBS	0 00:13	0.22	
10.03.2008	06:47	10.03.2008	08:49	Swath survey to OBS site#112	Swath	0 02:02	2.03	
10.03.2008	08:49	10.03.2008	09:06	OBS#111 recovered; 35 04.1S 73 15.4W	OBS	0 00:17	0.28	
10.03.2008	09:06	10.03.2008	09:52	Repositioning & interrogating OBS	RWP	0 00:46	0.77	
10.03.2008	09:52	10.03.2008	10:01	OBS#113 recovered; 35 02.4S 73 19.5W	OBS	0 00:09	0.15	
10.03.2008	10:01	10.03.2008	10:44	Repositioning & interrogating OBS	RWP	0 00:43	0.72	
10.03.2008	10:44	10.03.2008	11:01	OBS#114 recovered; 35 00.7S 73 23.6W	OBS	0 00:17	0.28	
10.03.2008	11:01	10.03.2008	11:54	Repositioning & interrogating OBS	RWP	0 00:53	0.88	
10.03.2008	11:54	10.03.2008	12:10	OBS#115 recovered; 34 59.3S 73 27.4W	OBS	0 00:16	0.27	
10.03.2008	12:10	10.03.2008	13:01	Repositioning & interrogating OBS	RWP	0 00:51	0.85	
10.03.2008	13:01	10.03.2008	13:30	OBS#116 recovered; 34 57.9S 73 30.6W	OBS	0 00:29	0.48	
10.03.2008	13:30	10.03.2008	14:59	Repositioning & interrogating OBS	RWP	0 01:29	1.48	
10.03.2008	14:59	10.03.2008	15:39	OBS#118 recovered; 34 54.8S 73 39.2W	OBS	0 00:40	0.67	
10.03.2008	15:39	10.03.2008	16:10	Repositioning	RWP	0 00:31	0.52	
10.03.2008	16:10	10.03.2008	16:27	OBS#119 recovered; 34 53.6S 73 42.6W	OBS	0 00:17	0.28	
10.03.2008	16:27	10.03.2008	17:07	Repositioning	RWP	0 00:40	0.67	
10.03.2008	17:07	10.03.2008	17:33	OBS#120 recovered; 34 52.2S 73 46.4W	OBS	0 00:26	0.43	
10.03.2008	17:33	10.03.2008	18:30	Repositioning	RWP	0 00:57	0.95	
10.03.2008	18:30	10.03.2008	19:00	OBS#122 recovered; 34 49.8S 73 53.8W	OBS	0 00:30	0.50	
10.03.2008	19:00	10.03.2008	19:30	Repositioning	RWP	0 00:30	0.50	
10.03.2008	19:30	10.03.2008	19:48	OBS#123 recovered; 34 48.3S 73 57.8W	OBS	0 00:18	0.30	
10.03.2008	19:48	10.03.2008	20:41	Repositioning	RWP	0 00:53	0.88	
10.03.2008	20:41	10.03.2008	21:07	OBS#125 recovered; 34 45.4S 74 04.6W	OBS	0 00:26	0.43	
10.03.2008	21:07	10.03.2008	21:45	Repositioning	RWP	0 00:38	0.63	

Appendix 15.8: Timetable

Cruise JC23a

Timetable of Events

R.R.S. James Cook

Start		End		All times Local time	Comment	Indicator	dd hh:mm	hours
Date	Time	Date	Time					
10.03.2008	21:45	10.03.2008	22:01	OBS#126 recovered; 34 43.3S 74 08.6W	OBS	0 00:16	0.27	
10.03.2008	22:01	10.03.2008	22:54	Repositioning	RWP	0 00:53	0.88	
10.03.2008	22:54	10.03.2008	23:26	OBS#128 recovered; 34 40.4S 74 15.3W	OBS	0 00:32	0.53	
10.03.2008	23:26	11.03.2008	00:06	Repositioning	RWP	0 00:40	0.67	
11.03.2008	00:06	11.03.2008	00:30	OBS#130 recovered; 34 37.6S 74 22.8W	OBS	0 00:24	0.40	
11.03.2008	00:30	11.03.2008	01:00	Securing deck & retracting azi thruster	RWP	0 00:30	0.50	
11.03.2008	01:00	11.03.2008	08:57	Swath survey; 34 37.7S 74 22.8W to 34 45.6S 74 22.5W to 35 20.0S 73 20.0W	Swath	0 07:57	7.95	
11.03.2008	08:57	11.03.2008	09:09	OBS#700 released in 35 20.00S 73 19.96W	OBS	0 00:12	0.20	
11.03.2008	09:09	11.03.2008	11:02	Repositioning	RWP	0 01:53	1.88	
11.03.2008	11:02	11.03.2008	11:32	OBS#111 recovered; 35 05.8S 73 11.8W	OBS	0 00:30	0.50	
11.03.2008	11:32	11.03.2008	12:06	Repositioning	RWP	0 00:34	0.57	
11.03.2008	12:06	11.03.2008	12:36	OBS#110 recovered; 35 07.4S 73 07.9W	OBS	0 00:30	0.50	
11.03.2008	12:36	11.03.2008	17:31	V/I in transit to inshore end of 2nd seismic line for along-line OBS deployments	RWP	0 04:55	4.92	
11.03.2008	17:31	11.03.2008	17:43	OBS#302 released in 34 50.36S 72 18.83W	OBS	0 00:12	0.20	
11.03.2008	17:43	11.03.2008	18:11	Repositioning	RWP	0 00:28	0.47	
11.03.2008	18:11	11.03.2008	18:23	OBS#303 released in 34 49.01S 72 22.74W	OBS	0 00:12	0.20	
11.03.2008	18:23	11.03.2008	18:47	Repositioning	RWP	0 00:24	0.40	
11.03.2008	18:47	11.03.2008	18:59	OBS#304 released in 34 47.72S 72 26.68W	OBS	0 00:12	0.20	
11.03.2008	18:59	11.03.2008	19:28	Repositioning	RWP	0 00:29	0.48	
11.03.2008	19:28	11.03.2008	19:40	OBS#305 released in 34 46.36S 72 30.69W	OBS	0 00:12	0.20	
11.03.2008	19:40	11.03.2008	20:18	Repositioning	RWP	0 00:38	0.63	
11.03.2008	20:18	11.03.2008	20:30	OBS#306 released in 34 44.99S 72 34.63W	OBS	0 00:12	0.20	
11.03.2008	20:30	11.03.2008	21:05	Repositioning	RWP	0 00:35	0.58	
11.03.2008	21:05	11.03.2008	21:17	OBS#307 released in 34 43.60S 72 38.70W	OBS	0 00:12	0.20	
11.03.2008	21:17	11.03.2008	21:49	Repositioning	RWP	0 00:32	0.53	
11.03.2008	21:49	11.03.2008	22:01	OBS#308 released in 34 42.38S 72 42.34W	OBS	0 00:12	0.20	
11.03.2008	22:01	11.03.2008	22:31	Repositioning	RWP	0 00:30	0.50	
11.03.2008	22:31	11.03.2008	22:43	OBS#309 released in 34 41.07S 72 46.26W	OBS	0 00:12	0.20	
11.03.2008	22:43	11.03.2008	23:17	Repositioning	RWP	0 00:34	0.57	
11.03.2008	23:17	11.03.2008	23:29	OBS#310 released in 34 39.76S 72 50.20W	OBS	0 00:12	0.20	
11.03.2008	23:29	12.03.2008	00:13	Repositioning	RWP	0 00:44	0.73	
12.03.2008	00:13	12.03.2008	00:42	OBS#311 released in 34 38.38S 72 54.22W; MT released in 34 38.38S 72 54.19W	OBS	0 00:29	0.48	
12.03.2008	00:42	12.03.2008	01:10	Repositioning	RWP	0 00:28	0.47	
12.03.2008	01:10	12.03.2008	01:22	OBS#312 released in 34 37.01S 72 58.12W	OBS	0 00:12	0.20	
12.03.2008	01:22	12.03.2008	01:53	Repositioning	RWP	0 00:31	0.52	
12.03.2008	01:53	12.03.2008	02:05	OBS#313 released in 34 35.7S 73 02.00W	OBS	0 00:12	0.20	
12.03.2008	02:05	12.03.2008	02:33	Repositioning	RWP	0 00:28	0.47	
12.03.2008	02:33	12.03.2008	02:45	OBS#314 released in 34 34.42S 73 05.96W	OBS	0 00:12	0.20	
12.03.2008	02:45	12.03.2008	03:13	Repositioning	RWP	0 00:28	0.47	
12.03.2008	03:13	12.03.2008	03:25	OBS#315 released in 34 33.12S 73 09.89W	OBS	0 00:12	0.20	
12.03.2008	03:25	12.03.2008	03:55	Repositioning	RWP	0 00:30	0.50	
12.03.2008	03:55	12.03.2008	04:07	OBS#316 released in 34 31.78S 73 13.77W	OBS	0 00:12	0.20	

Appendix 15.8: Timetable

Cruise JC23a

R.R.S. James Cook

Start		End		All times Local time	Comment	Indicator	dd hh:mm	hours
Date	Time	Date	Time					
12.03.2008	04:07	12.03.2008	04:35	Repositioning		RWP	0 00:28	0.47
12.03.2008	04:35	12.03.2008	04:47	OBS#317 released in 34 30.47S 73 17.69W		OBS	0 00:12	0.20
12.03.2008	04:47	12.03.2008	05:13	Repositioning		RWP	0 00:26	0.43
12.03.2008	05:13	12.03.2008	05:25	OBS#318 released in 34 29.19S 73 21.53W		OBS	0 00:12	0.20
12.03.2008	05:25	12.03.2008	05:50	Repositioning		RWP	0 00:25	0.42
12.03.2008	05:50	12.03.2008	06:02	OBS#319 released in 34 27.85S 73 25.49W		OBS	0 00:12	0.20
12.03.2008	06:02	12.03.2008	06:32	Repositioning		RWP	0 00:30	0.50
12.03.2008	06:32	12.03.2008	06:57	MT unit released in 34 26.51S 73 29.42W adjacent to previously deployed OBS#320		OBS	0 00:25	0.42
12.03.2008	06:57	12.03.2008	07:24	Repositioning		RWP	0 00:27	0.45
12.03.2008	07:24	12.03.2008	07:39	OBS#321 released in 34 25.21S 73 33.38W		OBS	0 00:15	0.25
12.03.2008	07:39	12.03.2008	08:30	Repositioning		RWP	0 00:51	0.85
12.03.2008	08:30	12.03.2008	08:42	OBS#323 released in 34 22.50S 73 41.24W		OBS	0 00:12	0.20
12.03.2008	08:42	12.03.2008	09:25	Repositioning		RWP	0 00:43	0.72
12.03.2008	09:25	12.03.2008	09:37	MT unit released in 34 21.17S 73 45.18W adjacent to OBS#324		OBS	0 00:12	0.20
12.03.2008	09:37	12.03.2008	11:12	Repositioning Emergency exercise conducted @ 1030hrs		RWP	0 01:35	1.58
12.03.2008	11:12	12.03.2008	11:24	OBS#327 released in 34 17.18S 73 57.00W		OBS	0 00:12	0.20
12.03.2008	11:24	12.03.2008	12:25	Repositioning		RWP	0 01:01	1.02
12.03.2008	12:25	12.03.2008	12:37	MT unit released in 34 14.52S 74 04.81W adjacent to OBS#329		OBS	0 00:12	0.20
12.03.2008	12:37	12.03.2008	13:28	Repositioning		RWP	0 00:51	0.85
12.03.2008	13:28	12.03.2008	13:40	OBS#331 released in 34 11.91S 74 12.65W		OBS	0 00:12	0.20
12.03.2008	13:40	12.03.2008	14:18	Repositioning for start of swath survey		RWP	0 00:38	0.63
12.03.2008	14:18	12.03.2008	17:17	Swath survey 34 08.08S 74 12.14W to 34 17.90S 73 41.50W		Swath	0 02:59	2.98
12.03.2008	17:17	12.03.2008	18:30	Swath to 34 25.8S 73 45.1W		Swath	0 01:13	1.22
12.03.2008	18:30	12.03.2008	22:45	Swath to 34 10.9S 74 30.0W		Swath	0 04:15	4.25
12.03.2008	22:45	12.03.2008	23:42	Swath to 34 01.0S 74 29.3W		Swath	0 00:57	0.95
12.03.2008	23:42	13.03.2008	01:20	Swath to 34 07.6S 74 12.33W		Swath	0 01:38	1.63
13.03.2008	01:20	13.03.2008	02:12	Swath to 34 59.8S 74 10.7W		Swath	0 00:52	0.87
13.03.2008	02:12	13.03.2008	05:27	Completing Swath survey to 34 00:0S 74 47.0W		Swath	0 03:15	3.25
13.03.2008	05:27	13.03.2008	06:00	Preparing for air gun deployment, 2nd line (numbered '3')		RWP	0 00:33	0.55
13.03.2008	06:00	13.03.2008	07:45	Streaming 4 off air gun arrays & 1 off central single; to 34 03.22S 74 37.69W; commence soft start		AG	0 01:45	1.75
13.03.2008	07:45	13.03.2008	08:17	All guns online; magnetometer streamed; 34 04.1S 74 35.1W; vli speed 4.2 knots		AG	0 00:32	0.53
13.03.2008	08:17	13.03.2008	12:55	V/I passing over first OBS(#331) on line		AG	0 04:38	4.63
13.03.2008	12:55	13.03.2008	18:00	Air gunning continues; 34 20.0S 73 48.7W		AG	0 05:05	5.08
13.03.2008	18:00	13.03.2008	23:59	Air gunning continues; 34 29.7S 73 20.1W		AG	0 05:59	5.98
13.03.2008	23:59	14.03.2008	06:00	Air gunning continues; 34 39.2S 72 51.9W		AG	0 06:01	6.02
14.03.2008	06:00	14.03.2008	12:58	Air gunning continues; passing thro' EoL at 34 50.3S 72 18.9W		AG	0 06:58	6.97
14.03.2008	12:58	14.03.2008	13:20	Single gun recovered; reduced to 3 guns firing; magnetometer & streamer being recovered ahead of turn; 34 50.9S 72		AG	0 00:22	0.37
14.03.2008	13:20	14.03.2008	13:34	Running reciprocal 'dead leg'		AG	0 00:14	0.23
14.03.2008	13:34	14.03.2008	14:25	Commence 'soft start' building from 3 to 8 guns; 34 55.3S 72 18.7W		AG	0 00:51	0.85
14.03.2008	14:25	14.03.2008	15:10	V/I on track 022 degrees & comm. 15nm seismic run parallel to coast; streamer outboard; 34 54.9S		AG	0 00:45	0.75
14.03.2008	15:10	14.03.2008	18:10	EoL; streamer recovered; air guns off; 34 41.1S 72 14.4W		AG	0 03:00	3.00
14.03.2008	18:10	14.03.2008	18:35	V/I on recovery heading; 34 40.6S 72 15.5W		AG	0 00:25	0.42

R.R.S. James Cook

Appendix 15.8: Timetable

Cruise JC23a

Timetable of Events

Appendix 15.8: Timetable

R.R.S. James Cook

Cruise JC23a

Timetable of Events

Start		End		All times Local time	Comment	Indicator	dd hh:mm	hours
Date	Time	Date	Time					
14.03.2008	18:35	14.03.2008	19:35	All air guns recovered & azi thruster off & retracted; 34 45.3S 72 17.1W		AG	0 01:00	1.00
14.03.2008	19:35	14.03.2008	20:17	Repositioning to commence OBS recoveries		RWP	0 00:42	0.70
14.03.2008	20:17	14.03.2008	20:37	OBS#302 recovered; 34 50.4S 72 18.7W		OBS	0 00:20	0.33
14.03.2008	20:37	14.03.2008	21:05	Repositioning		RWP	0 00:28	0.47
14.03.2008	21:05	14.03.2008	21:25	OBS#303 recovered; 34 48.9S 72 22.8W		OBS	0 00:20	0.33
14.03.2008	21:25	14.03.2008	21:54	Repositioning		RWP	0 00:29	0.48
14.03.2008	21:54	14.03.2008	22:14	OBS#304 recovered; 34 47.6S 72 26.7W		OBS	0 00:20	0.33
14.03.2008	22:14	14.03.2008	22:40	Repositioning		RWP	0 00:26	0.43
14.03.2008	22:40	14.03.2008	22:55	OBS#305 recovered; 34 46.4S 72 30.7W		OBS	0 00:15	0.25
14.03.2008	22:55	14.03.2008	23:40	Preparing MT unit for release		RWP	0 00:45	0.75
14.03.2008	23:40	14.03.2008	23:46	MT unit#305 released in 34 46.36S 72 30.69W		OBS	0 00:06	0.10
14.03.2008	23:46	15.03.2008	00:14	Repositioning		RWP	0 00:28	0.47
15.03.2008	00:14	15.03.2008	00:29	OBS#306 recovered; 34 45.0S 72 34.7W		OBS	0 00:15	0.25
15.03.2008	00:29	15.03.2008	01:00	Repositioning		RWP	0 00:31	0.52
15.03.2008	01:00	15.03.2008	01:35	OBS#307 recovered; 34 43.7S 72 38.7W		OBS	0 00:35	0.58
15.03.2008	01:35	15.03.2008	01:47	Preparing MT unit for release		RWP	0 00:12	0.20
15.03.2008	01:47	15.03.2008	01:53	MT unit#307 released in 34 43.58S 72 38.74W		OBS	0 00:06	0.10
15.03.2008	01:53	15.03.2008	02:20	Repositioning		RWP	0 00:27	0.45
15.03.2008	02:20	15.03.2008	02:32	OBS#308 recovered; 34 42.5S 72 42.3W		OBS	0 00:12	0.20
15.03.2008	02:32	15.03.2008	03:02	Repositioning		RWP	0 00:30	0.50
15.03.2008	03:02	15.03.2008	03:19	OBS#309 recovered; 34 41.2S 72 46.2W		OBS	0 00:17	0.28
15.03.2008	03:19	15.03.2008	04:05	Repositioning & commence interrogation via o'board hydrophone		RWP	0 00:46	0.77
15.03.2008	04:05	15.03.2008	04:45	OBS#310 recovered; 34 40.0S 72 50.2W		OBS	0 00:40	0.67
15.03.2008	04:45	15.03.2008	06:17	Repositioning		RWP	0 01:32	1.53
15.03.2008	06:17	15.03.2008	06:29	MT unit#314 released in 34 34.45S 73 05.99W		OBS	0 00:12	0.20
15.03.2008	06:29	15.03.2008	06:59	Repositioning		RWP	0 00:30	0.50
15.03.2008	06:59	15.03.2008	07:15	OBS#315 recovered; 34 33.15S 73 09.56W		OBS	0 00:16	0.27
15.03.2008	07:15	15.03.2008	08:26	Repositioning + awaiting OBS to surface		RWP	0 01:11	1.18
15.03.2008	08:26	15.03.2008	08:46	OBS#316 recovered; 34 32.3S 73 12.7W		OBS	0 00:20	0.33
15.03.2008	08:46	15.03.2008	09:40	Repositioning & awaiting OBS to surface		RWP	0 00:54	0.90
15.03.2008	09:40	15.03.2008	10:00	OBS#317 recovered; 34 30.3S 73 17.2W		OBS	0 00:20	0.33
15.03.2008	10:00	15.03.2008	10:23	MT unit#317 released in 34 30.47S 73 17.69W		OBS	0 00:23	0.38
15.03.2008	10:23	15.03.2008	11:27	Repositioning & awaiting OBS to surface		RWP	0 01:04	1.07
15.03.2008	11:27	15.03.2008	11:47	OBS#318 recovered; 34 29.2S 73 21.0W		OBS	0 00:20	0.33
15.03.2008	11:47	15.03.2008	12:49	Repositioning & awaiting OBS to surface		RWP	0 01:02	1.03
15.03.2008	12:49	15.03.2008	13:09	OBS#319 recovered; 34 28.2S 73 25.2W		OBS	0 00:20	0.33
15.03.2008	13:09	15.03.2008	14:10	Repositioning		RWP	0 01:01	1.02
15.03.2008	14:10	15.03.2008	14:30	OBS#321 recovered; 34 25.4S 73 33.3W		OBS	0 00:20	0.33
15.03.2008	14:30	15.03.2008	15:26	Repositioning		RWP	0 00:56	0.93
15.03.2008	15:26	15.03.2008	15:46	OBS#323 recovered; 34 22.6S 73 41.1W		OBS	0 00:20	0.33
15.03.2008	15:46	15.03.2008	17:50	Repositioning		RWP	0 02:04	2.07
15.03.2008	17:50	15.03.2008	18:02	OBS#401 released in 34 15.84S 74 00.98W		OBS	0 00:12	0.20

Appendix 15.8: Timetable

R.R.S. James Cook

Cruise JC23a

Timetable of Events

Start		End		All times Local time	Comment	Indicator	dd hh:mm	hours
Date	Time	Date	Time					
15.03.2008	18:02	15.03.2008	18:25	Repositioning		RWP	0 00:23	0.38
15.03.2008	18:25	15.03.2008	18:37	OBS#402 released in 34 19.07S 74 02.53W		OBS	0 00:12	0.20
15.03.2008	18:37	15.03.2008	18:58	Repositioning		RWP	0 00:21	0.35
15.03.2008	18:58	15.03.2008	19:10	OBS#403 released in 34 22.30S 74 04.04W		OBS	0 00:12	0.20
15.03.2008	19:10	15.03.2008	19:34	Repositioning		RWP	0 00:24	0.40
15.03.2008	19:34	15.03.2008	19:46	OBS#404 released in 34 25.44S 74 05.59W		OBS	0 00:12	0.20
15.03.2008	19:46	15.03.2008	20:15	Repositioning		RWP	0 00:29	0.48
15.03.2008	20:15	15.03.2008	20:27	OBS#405 released in 34 28.74S 74 06.99W		OBS	0 00:12	0.20
15.03.2008	20:27	15.03.2008	20:59	Repositioning		RWP	0 00:32	0.53
15.03.2008	20:59	15.03.2008	21:11	OBS#406 released in 34 31.9S 74 08.5W		OBS	0 00:12	0.20
15.03.2008	21:11	15.03.2008	21:51	Repositioning		RWP	0 00:40	0.67
15.03.2008	21:51	15.03.2008	22:03	OBS#407 released in 34 37.00S 74 10.99W		OBS	0 00:12	0.20
15.03.2008	22:03	15.03.2008	22:25	Repositioning		RWP	0 00:22	0.37
15.03.2008	22:25	15.03.2008	22:37	OBS#408 released in 34 39.52S 74 12.17W		OBS	0 00:12	0.20
15.03.2008	22:37	15.03.2008	23:13	Securing deck prior to Swath survey; set co 150 degs		RWP	0 00:36	0.60
15.03.2008	23:13	15.03.2008	23:49	Swath to 34 44.6S 74 08.4W; A/c to 195 degs		Swath	0 00:36	0.60
15.03.2008	23:49	15.03.2008	01:17	Swath to 34 57.6S 74 12.6W; A/c to 252 degs		Swath	0 01:28	1.47
16.03.2008	01:17	16.03.2008	02:10	Complete Swath survey to 35 00.0S 74 21.9W		Swath	0 00:53	0.88
16.03.2008	02:10	16.03.2008	02:20	Setting up to commence air gun streaming for 3rd seismic line (#4)		RWP	0 00:10	0.17
16.03.2008	02:20	16.03.2008	03:39	34 58.3S 74 21.2W to 34 53.7S 74 19.0W; streaming gun arrays, magnetometer & streamer; commence soft start		AG	0 01:19	1.32
16.03.2008	03:39	16.03.2008	04:40	to 34 49.4S 74 16.9W; single gun streamed; all guns brought on line		AG	0 01:01	1.02
16.03.2008	04:40	16.03.2008	12:36	to 34 12.0S 73 59.4W; seismic run completed; commence recovery of gear		AG	0 07:56	7.93
16.03.2008	12:36	16.03.2008	14:30	to 34 13.9S 73 04.0W; all guns & associated gear recovered		AG	0 01:54	1.90
16.03.2008	14:30	16.03.2008	16:10	Repositioning		RWP	0 01:40	1.67
16.03.2008	16:10	16.03.2008	16:30	OBS#331 recovered; 34 11.7S 74 13.0W; v/l commencing swath run, Co 270 degs; speed 5 knots; magnetometer start		OBS	0 00:20	0.33
16.03.2008	16:30	16.03.2008	22:40	Swath to 34 12.3S 74 50.3W; A/c to 180 degs; incr to 9 knots		Swath	0 06:10	6.17
16.03.2008	22:40	16.03.2008	23:20	Swath to 34 17.8S 74 48.0W; A/c to 090 degs		Swath	0 00:40	0.67
16.03.2008	23:20	17.03.2008	02:16	Swath to 34 18.2S 74 13.9W; A/c to 180 degs		Swath	0 02:56	2.93
17.03.2008	02:16	17.03.2008	02:56	Swath to 34 23.9S 74 14.8W; A/c to 270 degs		Swath	0 00:40	0.67
17.03.2008	02:56	17.03.2008	05:10	Swath to 34 24.1S 74 39.9W; A/c to 180 degs		Swath	0 02:14	2.23
17.03.2008	05:10	17.03.2008	05:56	Swath to 34 29.8S 74 40.0W; A/c to 090 degs		Swath	0 00:46	0.77
17.03.2008	05:56	17.03.2008	08:09	Swath to 34 30.3S 74 18.0W; A/c to 153 degs		Swath	0 02:13	2.22
17.03.2008	08:09	17.03.2008	08:34	Concluding Swath to 34 34.7S 74 15.0W; magnetometer recovered		Swath	0 00:25	0.42
17.03.2008	08:34	17.03.2008	09:41	Repositioning to commence OBS recoveries		RWP	0 01:07	1.12
17.03.2008	09:41	17.03.2008	10:03	OBS#408 recovered; 34 39.2S 74 12.2W		OBS	0 00:22	0.37
17.03.2008	10:03	17.03.2008	10:41	Repositioning		RWP	0 00:38	0.63
17.03.2008	10:41	17.03.2008	10:56	OBS#407 recovered; 34 36.8S 74 11.2W		OBS	0 00:15	0.25
17.03.2008	10:56	17.03.2008	11:40	Repositioning		RWP	0 00:44	0.73
17.03.2008	11:40	17.03.2008	11:57	OBS#406 recovered; 34 31.6S 74 08.7W		OBS	0 00:17	0.28
17.03.2008	11:57	17.03.2008	12:39	Repositioning		RWP	0 00:42	0.70
17.03.2008	12:39	17.03.2008	12:59	OBS#405 recovered; 34 28.6S 74 07.2W		OBS	0 00:20	0.33
17.03.2008	12:59	17.03.2008	13:54	Repositioning & await surfacing OBS		RWP	0 00:55	0.92

Appendix 15.8: Timetable

Cruise JC23a

R.R.S. James Cook

Timetable of Events

Start		End		All times Local time	Comment	Indicator	dd hh:mm	hours
Date	Time	Date	Time					
17.03.2008	13:54	17.03.2008	14:14	OBS#404 recovered; 34 25.0S 74 06.0W		OBS	0 00:20	0.33
17.03.2008	14:14	17.03.2008	14:48	Repositioning		RWP	0 00:34	0.57
17.03.2008	14:48	17.03.2008	15:08	OBS#403 recovered; 34 21.9S 74 04.2W		OBS	0 00:20	0.33
17.03.2008	15:08	17.03.2008	15:51	Repositioning		RWP	0 00:43	0.72
17.03.2008	15:51	17.03.2008	16:11	OBS#402 recovered; 34 18.9S 74 02.8W		OBS	0 00:20	0.33
17.03.2008	16:11	17.03.2008	16:58	Repositioning		RWP	0 00:47	0.78
17.03.2008	16:58	17.03.2008	17:18	OBS#401 recovered; 34 15.7S 74 01.3W		OBS	0 00:20	0.33
17.03.2008	17:18	17.03.2008	18:19	Repositioning		RWP	0 01:01	1.02
17.03.2008	18:19	17.03.2008	18:39	OBS#327 recovered; 34 17.0S 73 57.0W		OBS	0 00:20	0.33
17.03.2008	18:39	17.03.2008	19:04	Securing check on deck due to weather/sea conditions		RWP	0 00:25	0.42
17.03.2008	19:04	18.03.2008	03:00	Courses & speeds various towards next station due to sea conditions		RWP	0 07:56	7.93
18.03.2008	03:00	18.03.2008	03:35	OBS#314 recovered; 34 34.3S 73 05.8W		OBS	0 00:35	0.58
18.03.2008	03:35	18.03.2008	04:16	Repositioning		RWP	0 00:41	0.68
18.03.2008	04:16	18.03.2008	04:36	OBS#313 recovered; 34 35.8S 73 01.8W		OBS	0 00:20	0.33
18.03.2008	04:36	18.03.2008	05:23	Repositioning		RWP	0 00:47	0.78
18.03.2008	05:23	18.03.2008	05:43	OBS#312 recovered; 34 37.0S 72 58.2W		OBS	0 00:20	0.33
18.03.2008	05:43	18.03.2008	06:21	Repositioning		RWP	0 00:38	0.63
18.03.2008	06:21	18.03.2008	06:41	OBS#311 recovered; 34 38.6S 72 54.2W		OBS	0 00:20	0.33
18.03.2008	06:41	18.03.2008	07:57	Repositioning		RWP	0 01:16	1.27
18.03.2008	07:57	18.03.2008	08:09	MT unit#309 deployed in 34 41.1S 72 46.2W		OBS	0 00:12	0.20
18.03.2008	08:09	18.03.2008	12:20	Repositioning to commence laying OBSs for Line#2		RWP	0 04:11	4.18
18.03.2008	12:20	18.03.2008	12:32	OBS#202 deployed in 35 08.12S 72 28.02W		OBS	0 00:12	0.20
18.03.2008	12:32	18.03.2008	13:03	Repositioning		RWP	0 00:31	0.52
18.03.2008	13:03	18.03.2008	13:15	OBS#203 deployed in 35 06.83S 72 31.98W		OBS	0 00:12	0.20
18.03.2008	13:15	18.03.2008	14:01	Repositioning		RWP	0 00:46	0.77
18.03.2008	14:01	18.03.2008	14:13	OBS#204 deployed in 35 05.52S 72 35.90W		OBS	0 00:12	0.20
18.03.2008	14:13	18.03.2008	14:43	Repositioning		RWP	0 00:30	0.50
18.03.2008	14:43	18.03.2008	14:55	OBS#205 deployed in 35 04.23S 72 39.80W		OBS	0 00:12	0.20
18.03.2008	14:55	18.03.2008	15:25	Repositioning		RWP	0 00:30	0.50
18.03.2008	15:25	18.03.2008	15:37	OBS#206 deployed in 35 02.95S 72 43.80W		OBS	0 00:12	0.20
18.03.2008	15:37	18.03.2008	16:09	Repositioning		RWP	0 00:32	0.53
18.03.2008	16:09	18.03.2008	16:21	OBS#207 deployed in 35 01.68S 72 47.73W		OBS	0 00:12	0.20
18.03.2008	16:21	18.03.2008	16:50	Repositioning		RWP	0 00:29	0.48
18.03.2008	16:50	18.03.2008	17:02	OBS#208 deployed in 35 00.31S 72 51.66W		OBS	0 00:12	0.20
18.03.2008	17:02	18.03.2008	17:30	Repositioning		RWP	0 00:28	0.47
18.03.2008	17:30	18.03.2008	17:42	OBS#209 deployed in 34 59.04S 72 55.69W		OBS	0 00:12	0.20
18.03.2008	17:42	18.03.2008	18:09	Repositioning		RWP	0 00:27	0.45
18.03.2008	18:09	18.03.2008	18:21	OBS#210 deployed in 34 57.73S 72 59.64W		OBS	0 00:12	0.20
18.03.2008	18:21	18.03.2008	18:46	Repositioning		RWP	0 00:25	0.42
18.03.2008	18:46	18.03.2008	18:58	OBS#211 deployed in 34 56.45S 73 03.55W		OBS	0 00:12	0.20
18.03.2008	18:58	18.03.2008	19:26	Repositioning		RWP	0 00:28	0.47
18.03.2008	19:26	18.03.2008	19:38	OBS#212 deployed in 34 55.15S 73 07.59W		OBS	0 00:12	0.20

Appendix 15.8: Timetable

R.R.S. James Cook

Cruise JC23a

Timetable of Events

Start		End		All times Local time	Comment	Indicator	dd hh:mm	hours
Date	Time	Date	Time					
18.03.2008	19:38	18.03.2008	20:17	Repositioning		RWP	0 00:39	0.65
18.03.2008	20:29	18.03.2008	20:29	OBS#213 deployed in 34 53.8S 73 11.5W		OBS	0 00:12	0.20
18.03.2008	20:29	18.03.2008	21:06	Repositioning		RWP	0 00:37	0.62
18.03.2008	21:06	18.03.2008	21:18	OBS#214 deployed in 34 52.33S 73 15.52W		OBS	0 00:12	0.20
18.03.2008	21:18	18.03.2008	21:51	Repositioning		RWP	0 00:33	0.55
18.03.2008	21:51	18.03.2008	22:03	OBS#215 deployed in 34 51.21S 73 19.48W		OBS	0 00:12	0.20
18.03.2008	22:03	18.03.2008	22:31	Repositioning		RWP	0 00:28	0.47
18.03.2008	22:31	18.03.2008	22:43	OBS#216 deployed in 34 49.9S 73 23.4W		OBS	0 00:12	0.20
18.03.2008	22:43	18.03.2008	23:12	Repositioning		RWP	0 00:29	0.48
18.03.2008	23:12	18.03.2008	23:24	OBS#217 deployed in 34 48.6S 73 27.37W		OBS	0 00:12	0.20
18.03.2008	23:24	18.03.2008	23:52	Repositioning		RWP	0 00:28	0.47
18.03.2008	00:04	19.03.2008	00:04	OBS#218 deployed in 34 47.4S 73 31.3W		OBS	0 00:12	0.20
19.03.2008	00:04	19.03.2008	00:32	Repositioning		RWP	0 00:28	0.47
19.03.2008	00:32	19.03.2008	00:44	OBS#219 deployed in 34 46.07S 73 35.30W		OBS	0 00:12	0.20
19.03.2008	00:44	19.03.2008	01:08	Repositioning		RWP	0 00:24	0.40
19.03.2008	01:08	19.03.2008	01:20	OBS#220 deployed in 34 44.76S 73 39.15W; commence swath survey - co. 320 degs		OBS	0 00:12	0.20
19.03.2008	01:20	19.03.2008	02:06	Swath to 34 40.0S 73 41.5W; A/c to 294 degs		Swath	0 00:46	0.77
19.03.2008	02:06	19.03.2008	06:41	Complete Swath survey to 34 22.50S 74 30.09W		Swath	0 04:35	4.58
19.03.2008	06:41	19.03.2008	07:23	Repositioning to 34 27.2S 74 30.0W for streaming of airguns		RWP	0 00:42	0.70
19.03.2008	07:23	19.03.2008	08:22	Streaming 4 off air gun arrays to 34 28.5S 74 27.5W; commencing soft start		AG	0 00:59	0.98
19.03.2008	08:22	19.03.2008	09:30	Single air gun, magnetometer & streamer streamed; all guns online; v/l @ 4 knots; co 112 degs; 34 30.3S 74 22.6W		AG	0 01:08	1.13
19.03.2008	09:30	19.03.2008	12:00	Seismic run continues; v/l posn 34 34.1S 74 11.2W		AG	0 02:30	2.50
19.03.2008	12:00	19.03.2008	18:00	Seismic run continues; v/l posn 34 43.2S 73 44.0W		AG	0 06:00	6.00
19.03.2008	18:00	20.03.2008	00:01	Seismic run continues; v/l posn 34 52.3S 73 16.4W		AG	0 06:01	6.02
20.03.2008	00:01	20.03.2008	03:28	Single gun recovered after entanglement due to beam sea/swell conditions; v/l posn 34 57.5S 73 00.0W		AG	0 03:27	3.45
20.03.2008	03:28	20.03.2008	09:45	End of main seismic line @ 35 08.1S 72 28.1W; recovering magnetometer & streamer prior to turns; reduce to 3 guns		AG	0 06:17	6.28
20.03.2008	09:45	20.03.2008	11:45	Turning on to start of coastal transect line @ 35 12.6S 72 30.5W; streamer deployed; 8 guns firing		AG	0 02:00	2.00
20.03.2008	11:45	20.03.2008	15:30	Completing coastal transect @ 34 58.9S 72 23.2W; recovering streamer prior to turn for recovery heading; guns stopp		AG	0 03:45	3.75
20.03.2008	15:30	20.03.2008	17:02	All guns recovered & secure @ 35 00.8S 72 27.5W; repositioning for OBS recoveries		AG	0 01:32	1.53
20.03.2008	17:02	20.03.2008	18:08	Repositioning		RWP	0 01:06	1.10
20.03.2008	18:08	20.03.2008	18:28	OBS#202 recovered in 35 08.0S 72 28.0W		OBS	0 00:20	0.33
20.03.2008	18:28	20.03.2008	19:01	Repositioning		RWP	0 00:33	0.55
20.03.2008	19:01	20.03.2008	19:21	OBS#203 recovered in 35 06.7S 72 32.0W		OBS	0 00:20	0.33
20.03.2008	19:21	20.03.2008	20:43	Repositioning, weather speed reductions & awaiting OBS to surface		RWP	0 01:22	1.37
20.03.2008	20:43	20.03.2008	21:03	OBS#204 recovered in 35 04.6S 72 36.2W		OBS	0 00:20	0.33
20.03.2008	21:03	20.03.2008	21:59	Repositioning, weather speed reductions & awaiting OBS to surface		RWP	0 00:56	0.93
20.03.2008	21:59	20.03.2008	22:19	OBS#205 recovered in 35 04.0S 72 40.1W		OBS	0 00:20	0.33
20.03.2008	22:19	20.03.2008	23:18	Repositioning, weather speed reductions & awaiting OBS to surface		RWP	0 00:59	0.98
20.03.2008	23:18	20.03.2008	23:38	OBS#206 recovered in 35 02.7S 72 44.1W		OBS	0 00:20	0.33
20.03.2008	23:38	21.03.2008	00:41	Repositioning, weather speed reductions & awaiting OBS to surface		RWP	0 01:03	1.05
21.03.2008	00:41	21.03.2008	01:01	OBS#207 recovered in 35 01.3S 72 48.0W		OBS	0 00:20	0.33
21.03.2008	01:01	21.03.2008	02:10	Repositioning, weather speed reductions & awaiting OBS to surface		RWP	0 01:09	1.15

Appendix 15.8: Timetable

Cruise JC23a

R.R.S. James Cook

Timetable of Events

Start		End		All times Local time	Comment	Indicator	dd hh:mm	hours
Date	Time	Date	Time					
21.03.2008	02:10	21.03.2008	02:30	OBS#208 recovered in 34 59.6S 72 52.2W		OBS	0 00:20	0.33
21.03.2008	02:30	21.03.2008	03:00	Delay due to alarms on stbd propulsion		DTShip	0 00:30	0.50
21.03.2008	03:00	21.03.2008	05:45	In transit to next OBS site		RWP	0 02:45	2.75
21.03.2008	05:45	21.03.2008	06:05	OBS#213 recovered in 34 53.8S 73 11.4W		OBS	0 00:20	0.33
21.03.2008	06:05	21.03.2008	06:48	Repositioning		RWP	0 00:43	0.72
21.03.2008	06:48	21.03.2008	07:08	OBS#214 recovered in 34 52.5S 73 15.5W		OBS	0 00:20	0.33
21.03.2008	07:08	21.03.2008	07:47	Repositioning		RWP	0 00:39	0.65
21.03.2008	07:47	21.03.2008	08:07	OBS#215 recovered in 34 51.2S 73 19.6W		OBS	0 00:20	0.33
21.03.2008	08:07	21.03.2008	09:02	Repositioning, weather speed reductions & awaiting OBS to surface		RWP	0 00:55	0.92
21.03.2008	09:02	21.03.2008	09:22	OBS#216 recovered in 34 49.9S 73 23.4W		OBS	0 00:20	0.33
21.03.2008	09:22	21.03.2008	10:16	Repositioning, weather speed reductions & awaiting OBS to surface		RWP	0 00:54	0.90
21.03.2008	10:16	21.03.2008	10:36	OBS#217 recovered in 34 48.6S 73 27.1W		OBS	0 00:20	0.33
21.03.2008	10:36	21.03.2008	11:41	Repositioning, weather speed reductions & awaiting OBS to surface		RWP	0 01:05	1.08
21.03.2008	11:41	21.03.2008	12:01	OBS#218 recovered in 34 47.4S 73 31.3W		OBS	0 00:20	0.33
21.03.2008	12:01	21.03.2008	13:04	Repositioning, weather speed reductions & awaiting OBS to surface		RWP	0 01:03	1.05
21.03.2008	13:04	21.03.2008	13:24	OBS#219 recovered in 34 45.6S 73 35.2W		OBS	0 00:20	0.33
21.03.2008	13:24	21.03.2008	14:10	Repositioning		RWP	0 00:46	0.77
21.03.2008	14:10	21.03.2008	14:30	OBS#220 recovered in 34 44.2S 73 39.2W; deck secure; in transit to next station		OBS	0 00:20	0.33
21.03.2008	14:30	21.03.2008	22:24	In transit to deploy extra network OBS; reduced revs due to sea state		RWP	0 07:54	7.90
21.03.2008	22:24	21.03.2008	22:36	OBS#705 deployed; 35 32.00S 73 05.00W		OBS	0 00:12	0.20
21.03.2008	22:36	22.03.2008	02:20	In transit back to Line#2 to complete OBS recoveries		RWP	0 03:44	3.73
22.03.2008	02:20	22.03.2008	03:07	OBS#209 recovered in 34 59.1S 72 56.0W		OBS	0 00:47	0.78
22.03.2008	03:07	22.03.2008	03:49	Repositioning		RWP	0 00:42	0.70
22.03.2008	03:49	22.03.2008	04:09	OBS#210 recovered in 34 57.7S 73 00.0W		OBS	0 00:20	0.33
22.03.2008	04:09	22.03.2008	04:54	Repositioning		RWP	0 00:45	0.75
22.03.2008	04:54	22.03.2008	05:14	OBS#211 recovered in 34 56.6S 73 04.0W		OBS	0 00:20	0.33
22.03.2008	05:14	22.03.2008	05:46	Repositioning		RWP	0 00:32	0.53
22.03.2008	05:46	22.03.2008	06:06	OBS#212 recovered in 34 55.2S 73 07.8W		OBS	0 00:20	0.33
22.03.2008	06:06	22.03.2008	11:40	In transit to trials area for JC023b		RWP	0 05:34	5.57
22.03.2008	11:40	22.03.2008	12:00	OBS#804 released in 34 21.4S 72 33.1W		OBS	0 00:20	0.33
22.03.2008	12:00	22.03.2008	12:28	OBS#803 released in 34 21.61S 72 33.04W		OBS	0 00:28	0.47
22.03.2008	12:28	22.03.2008	12:43	OBS#802 released in 34 21.81S 72 32.99W		OBS	0 00:15	0.25
22.03.2008	12:43	22.03.2008	13:05	OBS#801 released in 34 21.88S 72 32.92W		OBS	0 00:22	0.37
22.03.2008	13:05	22.03.2008	13:28	Repositioning		RWP	0 00:23	0.38
22.03.2008	13:28	22.03.2008	13:40	OBS#805 released in 34 20.36S 72 33.14W		OBS	0 00:12	0.20
22.03.2008	13:40	22.03.2008	13:58	Repositioning		RWP	0 00:18	0.30
22.03.2008	13:58	22.03.2008	14:10	OBS#806 released in 34 19.44S 72 33.95W		OBS	0 00:12	0.20
22.03.2008	14:10	22.03.2008	14:28	Repositioning		RWP	0 00:18	0.30
22.03.2008	14:28	22.03.2008	14:40	OBS#807 released in 34 18.40S 72 33.49W		OBS	0 00:12	0.20
22.03.2008	14:40	22.03.2008	15:50	Repositioning to deployment area for air gun array; 34 14.1S 72 30.7W		RWP	0 01:10	1.17
22.03.2008	15:50	22.03.2008	16:21	To 34 15.26S 72 31.95W; air gun array & hydrophone streamed; 2 guns on line		AG	0 00:31	0.52
22.03.2008	16:21	22.03.2008	18:12	To 34 22.72S 72 32.82W; complete south-going run; air gun beam recovered		AG	0 01:51	1.85

Appendix 15.8: Timetable

R.R.S. James Cook

Cruise JC23a

Timetable of Events

Start		End		All times Local time	Comment	Indicator	dd hh:mm	hours
Date	Time	Date	Time					
22.03.2008	18:12	22.03.2008	19:01	To 34 22.57S 72 33.11W; complete turn; air gun re-deployed & on line		AG	0 00:49	0,82
22.03.2008	19:01	22.03.2008	20:10	To 34 17.04S 72 33.67W; complete north-going run; guns off		AG	0 01:09	1,15
22.03.2008	20:10	22.03.2008	20:42	To 34 14.75S 72 34.00W; turn, head-to-swell completed & all AG gear recovered		AG	0 00:32	0,53
22.03.2008	20:42	22.03.2008	21:34	Repositioning for OBS recoveries		RWP	0 00:52	0,87
22.03.2008	21:34	22.03.2008	21:54	OBS#807 recovered in 34 18.4S 72 33.2W		OBS	0 00:20	0,33
22.03.2008	21:54	22.03.2008	22:21	Repositioning		RWP	0 00:27	0,45
22.03.2008	22:21	22.03.2008	22:41	OBS#806 recovered in 34 19.53S 72 33.08W		OBS	0 00:20	0,33
22.03.2008	22:41	22.03.2008	23:16	Repositioning		RWP	0 00:35	0,58
22.03.2008	23:16	22.03.2008	23:36	OBS#805 recovered in 34 20.4S 72 32.8W		OBS	0 00:20	0,33
22.03.2008	23:36	23.03.2008	00:02	Magnetometer streamed @ start of Swath survey via International Waters		Swath	0 00:26	0,43
23.03.2008	00:02	23.03.2008	00:18	34 17.15S 72 33.9W; set co 318 degs; spd 10 knots		Swath	0 00:16	0,27
23.03.2008	00:18	23.03.2008	04:00	To 33 52.2S 73 00.8W		Swath	0 03:42	3,70
23.03.2008	04:00	23.03.2008	08:00	To 33 23.4S 73 31.3W		Swath	0 04:00	4,00
23.03.2008	08:00	23.03.2008	12:00	To 32 53.4S 74 02.5W		Swath	0 04:00	4,00
23.03.2008	12:00	23.03.2008	16:00	To 32 23.3S 74 34.8W		Swath	0 04:00	4,00
23.03.2008	16:00	23.03.2008	20:00	To 31 53.3S 75 06.0W		Swath	0 04:00	4,00
23.03.2008	20:00	24.03.2008	00:05	To 31 22.0S 75 39.2W; v/l entering International Waters		Swath	0 04:05	4,08
24.03.2008	00:05	24.03.2008	03:44	To 31 09.5S 75 50.0W; A/c to 090 degs (Clocks advanced 1 hr at 0200 to GMT-3)		Swath	0 02:39	2,65
24.03.2008	03:44	24.03.2008	04:30	To 31 10.0S 75 29.7W; v/l re-entering Chilean EEZ		Swath	0 00:46	0,77
24.03.2008	04:30	24.03.2008	08:00	To 31 10.0S 74 49.8W		Swath	0 03:30	3,50
24.03.2008	08:00	24.03.2008	12:15	To 31 10.2S 74 00.0W; A/c 124 degs		Swath	0 04:15	4,25
24.03.2008	12:15	24.03.2008	16:00	To 31 31.0S 73 22.4W		Swath	0 03:45	3,75
24.03.2008	16:00	24.03.2008	18:27	To 31 43.8S 73 00.1W; A/c 137 degs		Swath	0 02:27	2,45
24.03.2008	18:27	24.03.2008	23:54	To 32 19.2S 72 24.1W; Magnetometer recovered; End of Science, 23a		Swath	0 05:27	5,45
24.03.2008	23:54	25.03.2008	04:00	To 32 40.9S 71 57.3W		Pass	0 04:06	4,10
25.03.2008	04:00	25.03.2008	07:15	Pta Angeles brg 171 x 3.6nm; ME tested astern; thrusters & manual steering tested; front & stbd desks; all satis		Pass	0 03:15	3,25
25.03.2008	07:15	25.03.2008	08:12	Valparaiso approaches & PoB		Pass	0 00:57	0,95
25.03.2008	08:12	25.03.2008	08:48	Harbour manoeuvring & all fast alongside #7 berth		Pass	0 00:36	0,60

Appendix 15.8: Timetable

Cruise JC23a

Timetable of Events

Aggregated Hours for each Activity

Indicator	Indicator	Indicator	Indicator	Indicator	Indicator	Indicator	Indicator	Indicator	Indicator	Indicator	Indicator	Indicator
Mob	Port	Pass	Anc	OBS	AG	Art	RWP	Swath	DTWx	DTShip	DTEquip	DTOther
33,60	0,40	20,60	23,50	52,48	123,82	4,27	213,20	103,73	0,00	0,50	0,00	0,00
												576,10

Indicator Legend

- Mob** Mobilising
- Port** Bunkering etc
- Pass** Pilotage & Passage
- Art** Acoustic release tests
- OBS** Ocean Bottom Seismographs
- AG** Air guns
- Anc** Anchorage
- Swath** Swath
- RWP** Reposition/Waiting/Preparation
- DTWx** Downtime weather
- DTShip** Downtime ship systems
- DTEquip** Downtime scientific systems
- DTOther** Downtime Other (Medical etc)

JC023a (Time) - Hours, %

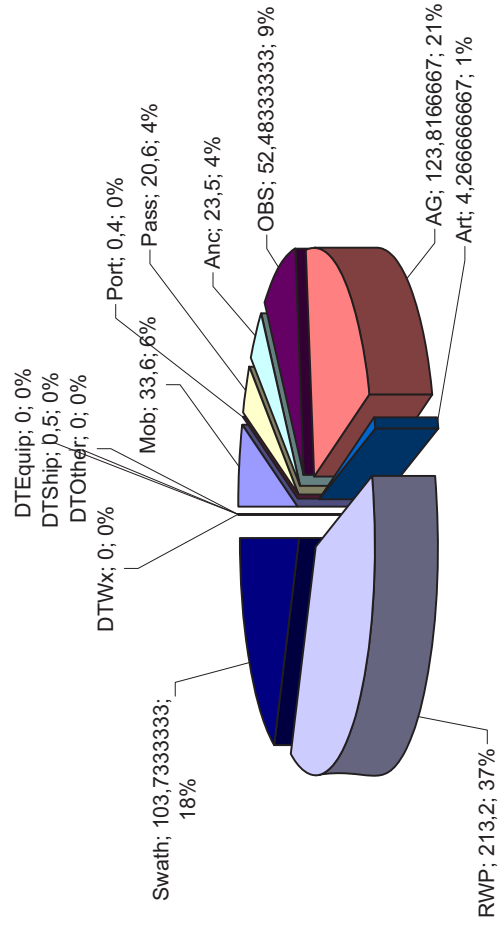

Appendix 15.8: Timetable

R.R.S. James Cook

Cruise JC023 Leg b

Timetable of Events

Start		End		Time	All times Local time	Comment	Indicator	dd hh:mm	hours
Date	Time	Date	Time						
26.03.2008	08:00	26.03.2008	18:00		Mobilising for JC023b @ Valparaiso; Crew reliefs; Sci/Tech party join	Mob	0 10:00	10.00	
26.03.2008	08:00	27.03.2008	09:02		Port time	Pass	0 15:02	15.03	
27.03.2008	19:02	27.03.2008	09:18		Harbour steaming	Pass	0 00:16	0.27	
27.03.2008	09:18	27.03.2008	23:59		Passage south from Valparaiso to work area; Emergency & Boat Stations Muster @ 1615hrs	Pass	0 14:41	14.68	
27.03.2008	23:59	28.03.2008	00:30		Manoeuvring in vicinity of OBS recovery site	RWP	0 00:31	0.52	
28.03.2008	00:30	28.03.2008	00:57		OBS#804 recovered; 34 21.3S 72 33.1W	OBS	0 10:36	10.60	
28.03.2008	00:57	28.03.2008	01:30		OBS#803 recovered	OBS	0 00:33	0.55	
28.03.2008	01:30	28.03.2008	01:58		OBS#802 recovered	OBS	0 00:28	0.47	
28.03.2008	01:58	28.03.2008	02:30		OBS#801 recovered; 34 21.9S 72 32.9W	OBS	0 00:32	0.53	
28.03.2008	02:30	28.03.2008	12:45		On passage to southern extremity of work area; Clocks retarded 1 hr @ 0300hrs	RWP	0 10:15	11.25	
28.03.2008	12:45	28.03.2008	13:00		OBS#901 deployed; 35 43.2S 73 18.7W	OBS	0 00:15	0.25	
28.03.2008	13:00	28.03.2008	13:52		OBS#903 deployed; 35 42.2S 73 22.3W	OBS	0 00:52	0.87	
28.03.2008	13:52	28.03.2008	14:17		OBS#904 deployed; 35 41.7S 73 24.2W	OBS	0 00:25	0.42	
28.03.2008	14:17	28.03.2008	14:41		OBS#905 deployed; 35 41.2S 73 26.0W	OBS	0 00:24	0.40	
28.03.2008	14:41	28.03.2008	15:05		OBS#906 deployed; 35 40.7S 73 27.7W	OBS	0 00:24	0.40	
28.03.2008	15:05	28.03.2008	15:29		OBS#907 deployed; 35 40.2S 73 29.5W	OBS	0 00:24	0.40	
28.03.2008	15:29	28.03.2008	15:53		OBS#908 deployed; 35 39.8S 73 30.9W	OBS	0 00:24	0.40	
28.03.2008	15:53	28.03.2008	16:23		OBS#909 deployed; 35 39.17S 73 33.48W	OBS	0 00:30	0.50	
28.03.2008	16:23	28.03.2008	16:55		OBS#910 deployed; 35 38.70S 73 35.22W	OBS	0 00:32	0.53	
28.03.2008	16:55	28.03.2008	17:25		OBS#911 deployed; 35 38.0S 73 37.00W	OBS	0 00:30	0.50	
28.03.2008	17:25	28.03.2008	17:58		OBS#912 deployed; 35 37.74S 73 38.65W	OBS	0 00:33	0.55	
28.03.2008	17:58	28.03.2008	18:26		OBS#913 deployed; 35 37.41S 73 39.90W	OBS	0 00:28	0.47	
28.03.2008	18:26	28.03.2008	19:00		OBS#914 deployed; 35 36.53S 73 43.20W	OBS	0 00:34	0.57	
28.03.2008	19:00	28.03.2008	19:29		OBS#915 deployed; 35 36.04S 73 44.99W	OBS	0 00:29	0.48	
28.03.2008	19:29	28.03.2008	20:02		OBS#916 deployed; 35 35.54S 73 46.74W	OBS	0 00:33	0.55	
28.03.2008	20:02	28.03.2008	20:34		OBS#917 deployed; 35 35.06S 73 48.51W	OBS	0 00:32	0.53	
28.03.2008	20:34	28.03.2008	20:58		OBS#918 deployed; 35 34.58S 73 50.14W	OBS	0 00:24	0.40	
28.03.2008	20:58	28.03.2008	21:58		Repositioning to 35 33.02S 73 56.13W for commencement of seismic run	RWP	0 01:00	1.00	
28.03.2008	21:58	28.03.2008	22:18		Air gun boom streamed; commence soft start	AG	0 00:20	0.33	
28.03.2008	22:18	28.03.2008	22:30		To 35 33.45S 73 54.50W; All guns (3) firing & hydrophone array streamed	AG	0 00:12	0.20	
28.03.2008	22:30	29.03.2008	03:00		To 35 37.7S 73 38.7W; continue seismic line	AG	0 04:30	4.50	
29.03.2008	03:00	29.03.2008	09:16		To 35 43.66S 73 16.91W; Eol; gun firing ceased	AG	0 06:16	6.27	
29.03.2008	09:16	29.03.2008	09:37		Seismic gear recovered	AG	0 00:21	0.35	
29.03.2008	09:37	29.03.2008	10:15		Repositioning for recovery of OBSs	RWP	0 00:38	0.63	
29.03.2008	10:15	29.03.2008	10:29		OBS#901 recovered; 35 43.29S 73 19.00W; continuing along WNW track	OBS	0 00:14	0.23	
29.03.2008	10:29	29.03.2008	11:04		OBS#903 recovered	OBS	0 00:35	0.58	
29.03.2008	11:04	29.03.2008	11:45		OBS#904 recovered	OBS	0 00:41	0.68	
29.03.2008	11:45	29.03.2008	12:15		OBS#905 recovered	OBS	0 00:30	0.50	
29.03.2008	12:15	29.03.2008	12:48		OBS#906 recovered	OBS	0 00:33	0.55	
29.03.2008	12:48	29.03.2008	13:17		OBS#907 recovered	OBS	0 00:29	0.48	
29.03.2008	13:17	29.03.2008	13:44		OBS#908 recovered	OBS	0 00:27	0.45	
29.03.2008	13:44	29.03.2008	14:21		OBS#909 recovered	OBS	0 00:37	0.62	

Appendix 15.8: Timetable

Cruise JC023 Leg b

R.R.S. James Cook

Start		End		All times Local time	Comment	Indicator	dd hh:mm	hours
Date	Time	Date	Time					
29.03.2008	14:21	29.03.2008	14:55	OBS#910 recovered		OBS	0 00:34	0,57
29.03.2008	14:55	29.03.2008	15:23	OBS#911 recovered		OBS	0 00:28	0,47
29.03.2008	15:23	29.03.2008	15:53	OBS#912 recovered		OBS	0 00:30	0,50
29.03.2008	15:53	29.03.2008	16:30	OBS#913 recovered		OBS	0 00:37	0,62
29.03.2008	16:30	29.03.2008	17:27	OBS#914 recovered		OBS	0 00:57	0,95
29.03.2008	17:27	29.03.2008	18:08	OBS#915 recovered		OBS	0 00:41	0,68
29.03.2008	18:08	29.03.2008	19:08	Waiting for surface of OBS#916, then re-positioning after 'no show'		RWP	0 01:00	1,00
29.03.2008	19:08	29.03.2008	19:30	OBS#917 recovered		OBS	0 00:22	0,37
29.03.2008	19:30	29.03.2008	20:10	Returning to & recovery of OBS#916		OBS	0 00:40	0,67
29.03.2008	20:10	29.03.2008	20:35	Repositioning		RWP	0 00:25	0,42
29.03.2008	20:35	29.03.2008	20:50	OBS#918 recovered; 35 34.7S 73 50.0W		OBS	0 00:15	0,25
29.03.2008	20:50	29.03.2008	21:50	Repositioning to 35 31.6S 73 45.2W		RWP	0 01:00	1,00
29.03.2008	21:50	30.03.2008	04:28	Swath survey to 36 04.2S 73 37.0W		Swath	0 06:38	6,63
30.03.2008	04:28	30.03.2008	05:05	OBS#1001 deployed; 36 03.0S 73 39.3W		OBS	0 00:37	0,62
30.03.2008	05:05	30.03.2008	05:36	OBS#1002 deployed; 36 02.14S 73 38.69W		OBS	0 00:31	0,52
30.03.2008	05:36	30.03.2008	06:04	OBS#1003 deployed; 36 01.33S 73 38.02W		OBS	0 00:28	0,47
30.03.2008	06:04	30.03.2008	06:33	OBS#1004 deployed; 36 00.41S 73 37.38W		OBS	0 00:29	0,48
30.03.2008	06:33	30.03.2008	07:08	OBS#1005 deployed; 35 59.30S 73 36.58W		OBS	0 00:35	0,58
30.03.2008	07:08	30.03.2008	07:32	OBS#1006 deployed; 35 58.17S 73 35.75W		OBS	0 00:24	0,40
30.03.2008	07:32	30.03.2008	07:52	OBS#1007 deployed; 35 57.09S 73 34.94W		OBS	0 00:20	0,33
30.03.2008	07:52	30.03.2008	08:10	OBS#1008 deployed; 35 56.07S 73 34.19W		OBS	0 00:18	0,30
30.03.2008	08:10	30.03.2008	08:30	OBS#1009 deployed; 35 55.23S 73 33.54W		OBS	0 00:20	0,33
30.03.2008	08:30	30.03.2008	08:52	OBS#1010 deployed; 35 54.04S 73 32.66W		OBS	0 00:22	0,37
30.03.2008	08:52	30.03.2008	09:13	OBS#1011 deployed; 35 52.87S 73 31.76W		OBS	0 00:21	0,35
30.03.2008	09:13	30.03.2008	09:29	OBS#1012 deployed; 35 52.07S 73 31.09W		OBS	0 00:16	0,27
30.03.2008	09:29	30.03.2008	09:49	OBS#1013 deployed; 35 51.20S 73 30.49W		OBS	0 00:20	0,33
30.03.2008	09:49	30.03.2008	11:32	Repositioning to 35 42.1S 73 23.5W for start of Side scan/seismic run		RWP	0 01:43	1,72
30.03.2008	11:32	30.03.2008	13:39	Running to Sol 1/1; 35 46.8S 73 27.2W; Streaming air gun boom, DTS1 (side scan); hydrophone & lowering USBL (stb)		DTS1	0 02:07	2,12
30.03.2008	13:39	30.03.2008	18:00	To 35 58.5S 73 35.9W; continue side scan & seismic (reduced capacity - 2 of 3 guns on boom)		DTS1	0 04:21	4,35
30.03.2008	18:00	30.03.2008	20:42	To 36 05.7S 73 41.4W; Eol; commence recovery of all gear for checks/repairs		DTS1	0 02:42	2,70
30.03.2008	20:42	30.03.2008	21:48	To 36 08.4S 73 43.4W; All gear inboard		DTS1	0 01:06	1,10
30.03.2008	21:48	30.03.2008	22:45	Repositioning to 36 08.0S 73 45.3W for Sol 1/2		RWP	0 00:57	0,95
30.03.2008	22:45	30.03.2008	23:45	Holding position, waiting on repair		DTEquip	0 01:00	1,00
30.03.2008	23:45	31.03.2008	00:15	To 36 06.9S 73 44.6W; DTS1, air gun array & hydrophone array streamed		DTS1	0 00:30	0,50
31.03.2008	00:15	31.03.2008	01:36	Running to Sol 1/2; 36 03.8S 73 42.2W		DTS1	0 01:21	1,35
31.03.2008	01:36	31.03.2008	09:06	To 35 44.6S 73 27.7W; Eol 1/2; hauling DTS1 @ commencement of turn		DTS1	0 07:30	7,50
31.03.2008	09:06	31.03.2008	10:46	To 35 44.8S 73 24.7W; veering DTS1 & gun soft start approaching Sol 1/3		DTS1	0 01:40	1,67
31.03.2008	10:46	31.03.2008	14:20	To 35 54.2S 73 31.7W; whale sighted within 600m - guns stopped		DTS1	0 03:34	3,57
31.03.2008	14:20	31.03.2008	14:42	Re-starting guns		DTS1	0 00:22	0,37
31.03.2008	14:42	31.03.2008	19:06	To 36 06.1S 73 40.6W; Eol 1/3; hauling DTS1 @ commencement of turn		DTS1	0 04:24	4,40
31.03.2008	19:06	31.03.2008	20:18	To 36 05.9S 73 42.7W; veering DTS1 & gun soft start approaching Sol 1/4		DTS1	0 01:12	1,20
31.03.2008	20:18	01.04.2008	04:12	To 35 45.2S 73 27.0W; Eol 1/4; hauling DTS1 @ commencement of turn		DTS1	0 07:54	7,90

Timetable of Events

Appendix 15.8: Timetable

Cruise JC023 Leg b

R.R.S. James Cook

Start		End		Time	All times Local time	Comment	Indicator	dd hh:mm	hours
Date	Time	Date	Time						
01.04.2008	04:12	01.04.2008	05:57	To 35 47.5S 73 25.5W; veering DTS1 & soft gun start approaching Sol. 1/5	DTS1	0 01:45	1.75		
01.04.2008	05:57	01.04.2008	12:53	To 36 05.9S 73 39.3W; EoL 1/5; A/c to 222 degs and continue survey run to the south of Area#1	DTS1	0 06:56	6.93		
01.04.2008	12:53	01.04.2008	14:15	To 36 08.9S 73 42.7W; A/c to 183 degs	DTS1	0 01:22	1.37		
01.04.2008	14:15	01.04.2008	19:17	To 36 23.9S 73 43.7W; A/c to 171 degs	DTS1	0 05:02	5.03		
01.04.2008	19:17	01.04.2008	22:51	To 36 34.5S 73 41.7W; EoL; air guns stopped; commence recovery of airgun array, DTS1, etc	DTS1	0 03:34	3.57		
01.04.2008	22:51	01.04.2008	23:50	All gear recovered; securing the deck	DTS1	0 00:59	0.98		
01.04.2008	23:50	02.04.2008	00:55	To 36 37.7S 73 42.4W; deck secure; continue on swath/bathy survey @5 knots	Swath	0 01:05	1.08		
02.04.2008	00:55	02.04.2008	02:02	To 36 41.5S 73 43.9W; A/c to 336 degs	Swath	0 01:07	1.12		
02.04.2008	02:02	02.04.2008	04:31	To 36 31.6S 73 49.2W; A/c to 311 degs	Swath	0 02:29	2.48		
02.04.2008	04:31	02.04.2008	06:23	To 36 26.8S 73 56.0W; A/c to 038 degs	Swath	0 01:52	1.87		
02.04.2008	06:23	02.04.2008	09:58	To 36 15.2S 73 44.8W; Complete swath survey	Swath	0 03:35	3.58		
02.04.2008	09:58	02.04.2008	11:40	Repositioning for series of OBS recoveries	RWP	0 01:42	1.70		
02.04.2008	11:40	02.04.2008	12:00	OBS#1001 recovered; 36 03.1S 73 39.5W; continuing along NNE track	OBS	0 00:20	0.33		
02.04.2008	12:00	02.04.2008	12:53	OBS#1002 recovered	OBS	0 00:53	0.88		
02.04.2008	12:53	02.04.2008	13:23	OBS#1003 recovered	OBS	0 00:30	0.50		
02.04.2008	13:23	02.04.2008	13:52	OBS#1004 recovered	OBS	0 00:29	0.48		
02.04.2008	13:52	02.04.2008	14:19	OBS#1005 recovered	OBS	0 00:27	0.45		
02.04.2008	14:19	02.04.2008	14:47	OBS#1006 recovered	OBS	0 00:28	0.47		
02.04.2008	14:47	02.04.2008	15:13	OBS#1007 recovered	OBS	0 00:26	0.43		
02.04.2008	15:13	02.04.2008	15:36	OBS#1008 recovered	OBS	0 00:23	0.38		
02.04.2008	15:36	02.04.2008	15:59	OBS#1009 recovered	OBS	0 00:23	0.38		
02.04.2008	15:59	02.04.2008	16:30	OBS#1010 recovered	OBS	0 00:31	0.52		
02.04.2008	16:30	02.04.2008	16:55	OBS#1011 recovered	OBS	0 00:25	0.42		
02.04.2008	16:55	02.04.2008	17:55	Waiting for surface of OBS#1012	OBS	0 01:00	1.00		
02.04.2008	17:55	02.04.2008	18:15	OBS#1012 recovered	OBS	0 00:20	0.33		
02.04.2008	18:15	02.04.2008	19:28	OBS#1013 recovered; 35 51.1S 73 31.0W	OBS	0 01:13	1.22		
02.04.2008	19:28	02.04.2008	20:30	Repositioning to 35 49.5S 73 30.2W for start of o'night swath/bathy run	RWP	0 01:02	1.03		
02.04.2008	20:30	02.04.2008	22:51	To 35 38.3S 73 28.2W; A/c to 345 degs	Swath	0 02:21	2.35		
02.04.2008	22:51	02.04.2008	23:37	To 35 34.7S 73 29.4W; A/c to 016 degs	Swath	0 00:46	0.77		
02.04.2008	23:37	03.04.2008	00:03	To 35 32.8S 73 28.6W; A/c to 054 degs	Swath	0 00:26	0.43		
03.04.2008	00:03	03.04.2008	01:06	To 35 30.4S 73 23.9W; A/c to 098 degs	Swath	0 01:03	1.05		
03.04.2008	01:06	03.04.2008	02:07	To 35 31.0S 73 17.9W; A/c to 338 degs	Swath	0 01:01	1.02		
03.04.2008	02:07	03.04.2008	03:41	To 35 23.9S 73 21.2W; A/c to 216 degs	Swath	0 01:34	1.57		
03.04.2008	03:41	03.04.2008	04:17	To 35 26.2S 73 23.1W; A/c to 224 degs	Swath	0 00:36	0.60		
03.04.2008	04:17	03.04.2008	05:25	To 35 30.4S 73 27.9W; A/c to 241 degs	Swath	0 01:08	1.13		
03.04.2008	05:25	03.04.2008	08:00	To 35 36.1S 73 39.9W; Comp swath run to 1st core site	Swath	0 02:35	2.58		
03.04.2008	08:00	03.04.2008	10:36	Core#1 to 2894m	Core	0 02:36	2.60		
03.04.2008	10:36	03.04.2008	11:45	Delay due to failure of core tower recovery winch	DTShip	0 01:09	1.15		
03.04.2008	11:45	03.04.2008	15:00	Transit to OBS recovery site 35 10.0S 73 52.7W; (to be classified as downtime)	DTShip	0 03:15	3.25		
03.04.2008	15:00	03.04.2008	15:48	OBS#701 recovered	OBS	0 00:48	0.80		
03.04.2008	15:48	03.04.2008	16:36	Repositioning	RWP	0 00:48	0.80		
03.04.2008	16:36	03.04.2008	16:48	OBS#L08 deployed; 35 15.0S 73 56.0W	OBS	0 00:12	0.20		

Timetable of Events

Appendix 15.8: Timetable

Cruise JC023 Leg b

R.R.S. James Cook

Start		End		Time	All times Local time	Comment	Indicator	dd hh:mm	hours
Date	Time	Date	Time						
03.04.2008	16:48	03.04.2008	19:54	19:54	Transit back to core site; 35 36.1S 73 40.6W; (to be classified as downtime)	DTShip	0 03:06	3,10	
03.04.2008	19:54	03.04.2008	22:30	22:30	Core#2 to 3384m	Core	0 02:36	2,60	
03.04.2008	22:30	04.04.2008	01:10	01:10	Core#3 to 3919m	Core	0 02:40	2,67	
04.04.2008	01:10	04.04.2008	01:42	01:42	Comm deployment of Core#3a	Core	0 00:32	0,53	
04.04.2008	01:42	04.04.2008	03:15	03:15	Delay due to Core winch electronic problems; core barrel recovered to horiz tower	DTShip	0 01:33	1,55	
04.04.2008	03:15	04.04.2008	11:24	11:24	Re-scheduling of science; Transit to OBS recovery site 34 44.8S 74 48.0W	RWP	0 08:09	8,15	
04.04.2008	11:24	04.04.2008	11:54	11:54	OBS#702 recovered	OBS	0 00:30	0,50	
04.04.2008	11:54	04.04.2008	14:06	14:06	Repositioning to 34 35.3S 74 28.4W	RWP	0 02:12	2,20	
04.04.2008	14:06	04.04.2008	14:28	14:28	OBS#131 recovered	OBS	0 00:22	0,37	
04.04.2008	14:28	04.04.2008	15:23	15:23	Repositioning to 34 37.1S 74 31.8W	RWP	0 00:55	0,92	
04.04.2008	15:23	04.04.2008	18:31	18:31	Core#4 to 4242m	Core	0 03:08	3,13	
04.04.2008	18:31	04.04.2008	20:40	20:40	Repositioning to 34 41.6S 74 13.3W	RWP	0 02:09	2,15	
04.04.2008	20:40	04.04.2008	21:10	21:10	OBS#127 recovered	OBS	0 00:30	0,50	
04.04.2008	21:10	05.04.2008	01:10	01:10	Core#5 to 4157m	Core	0 04:00	4,00	
05.04.2008	01:10	05.04.2008	02:36	02:36	Repositioning to 34 46.0S 74 01.5W	RWP	0 01:26	1,43	
05.04.2008	02:36	05.04.2008	03:19	03:19	OBS#124 recovered	OBS	0 00:43	0,72	
05.04.2008	03:19	05.04.2008	05:00	05:00	Repositioning to 34 50.7S 73 50.1W	RWP	0 01:41	1,68	
05.04.2008	05:00	05.04.2008	05:37	05:37	OBS#121 recovered	OBS	0 00:37	0,62	
05.04.2008	05:37	05.04.2008	07:05	07:05	Repositioning to 34 43.3S 73 43.1W	RWP	0 01:28	1,47	
05.04.2008	07:05	05.04.2008	07:36	07:36	OBS#221 recovered	OBS	0 00:31	0,52	
05.04.2008	07:36	05.04.2008	08:42	08:42	Repositioning to 34 41.1S 73 51.1W	RWP	0 01:06	1,10	
05.04.2008	08:42	05.04.2008	09:12	09:12	OBS#224 recovered	OBS	0 00:30	0,50	
05.04.2008	09:12	05.04.2008	10:48	10:48	Repositioning to 34 37.1S 74 02.6W	RWP	0 01:36	1,60	
05.04.2008	10:48	05.04.2008	11:18	11:18	OBS#227 recovered	OBS	0 00:30	0,50	
05.04.2008	11:18	05.04.2008	12:18	12:18	Repositioning to 34 34.4S 74 10.7W	RWP	0 01:00	1,00	
05.04.2008	12:18	05.04.2008	12:48	12:48	OBS#229 recovered	OBS	0 00:30	0,50	
05.04.2008	12:48	05.04.2008	16:35	16:35	Securing deck & repositioning to 34 14.4S 74 04.8W	RWP	0 03:47	3,78	
05.04.2008	16:35	05.04.2008	17:05	17:05	MT#329 recovered	OBS	0 00:30	0,50	
05.04.2008	17:05	05.04.2008	20:42	20:42	Core#6 to 4172m; 34 14.59S 74 05.18W	Core	0 03:37	3,62	
05.04.2008	20:42	05.04.2008	21:24	21:24	To 34 12.9S 74 05.6W Streamer deployed @ 2.5 knots for test purposes	AG	0 00:42	0,70	
05.04.2008	21:24	05.04.2008	23:25	23:25	Repositioning to 33 54.1S 74 05.2W	RWP	0 02:01	2,02	
05.04.2008	23:25	05.04.2008	23:52	23:52	OBS#504 recovered	OBS	0 00:27	0,45	
05.04.2008	23:52	06.04.2008	02:50	02:50	Repositioning to 34 19.8S 73 49.1W	RWP	0 02:58	2,97	
06.04.2008	02:50	06.04.2008	03:23	03:23	OBS#325 recovered	OBS	0 00:33	0,55	
06.04.2008	03:23	06.04.2008	04:15	04:15	Repositioning to 34 21.0S 73 45.1W	RWP	0 00:52	0,87	
06.04.2008	04:15	06.04.2008	06:00	06:00	Waiting for instrument to surface	RWP	0 01:45	1,75	
06.04.2008	06:00	06.04.2008	06:20	06:20	MT#324 recovered	OBS	0 00:20	0,33	
06.04.2008	06:20	06.04.2008	08:24	08:24	Repositioning to 34 26.3S 73 29.3W	RWP	0 02:04	2,07	
06.04.2008	08:24	06.04.2008	10:04	10:04	Waiting for instrument to surface	RWP	0 01:40	1,67	
06.04.2008	10:04	06.04.2008	10:30	10:30	MT#320 recovered	OBS	0 00:26	0,43	
06.04.2008	10:30	06.04.2008	12:15	12:15	Repositioning	RWP	0 01:45	1,75	
06.04.2008	12:15	06.04.2008	12:33	12:33	OBS#L01 deployed in 34 15.0S 73 22.0W	OBS	0 00:18	0,30	

Timetable of Events

Appendix 15.8: Timetable

Cruise JC023 Leg b

R.R.S. James Cook

Start		End		Time	All times Local time	Comment	Indicator	dd hh:mm	hours
Date	Time	Date	Time						
06.04.2008	12:33	06.04.2008	13:00		Repositioning to 34 11.8S 73 20.1W		RWP	0 00:27	0,45
06.04.2008	13:00	06.04.2008	13:24		OBS#503 recovered		OBS	0 00:24	0,40
06.04.2008	13:24	06.04.2008	15:56		Repositioning to 34 30.3S 73 17.5W		RWP	0 02:32	2,53
06.04.2008	15:56	06.04.2008	17:56		Waiting for instrument to surface		RWP	0 02:00	2,00
06.04.2008	17:56	06.04.2008	18:18		MT#317 recovered		OBS	0 00:22	0,37
06.04.2008	18:18	06.04.2008	20:10		Repositioning to 34 34.3S 73 05.7W		RWP	0 01:52	1,87
06.04.2008	20:10	06.04.2008	21:10		Waiting for instrument to surface		RWP	0 01:00	1,00
06.04.2008	21:10	06.04.2008	21:30		MT#314 recovered		OBS	0 00:20	0,33
06.04.2008	21:30	06.04.2008	23:35		Securing deck & repositioning to 34 38.1S 72 54.1W		RWP	0 02:05	2,08
06.04.2008	23:35	07.04.2008	01:50		MT#311 not seen or detected surfacing		RWP	0 02:15	2,25
07.04.2008	01:50	07.04.2008	02:56		Repositioning to 34 40.9S 72 46.2W		RWP	0 01:06	1,10
07.04.2008	02:56	07.04.2008	03:33		MT#309 recovered		OBS	0 00:37	0,62
07.04.2008	03:33	07.04.2008	04:53		Repositioning to 34 43.4S 72 38.7W		RWP	0 01:20	1,33
07.04.2008	04:53	07.04.2008	05:38		MT#307 recovered		OBS	0 00:45	0,75
07.04.2008	05:38	07.04.2008	07:55		Securing deck & repositioning		RWP	0 02:17	2,28
07.04.2008	07:55	07.04.2008	08:07		OBS#L02 deployed in 34 35.5S 72 23.0W		OBS	0 00:12	0,20
07.04.2008	08:07	07.04.2008	09:53		Repositioning to 34 46.4S 72 30.8W		RWP	0 01:46	1,77
07.04.2008	09:53	07.04.2008	10:13		MT#305 recovered		OBS	0 00:20	0,33
07.04.2008	10:13	07.04.2008	11:19		Repositioning		RWP	0 01:06	1,10
07.04.2008	11:19	07.04.2008	11:31		OBS#L03 deployed in 34 53.5S 72 38.0W		OBS	0 00:12	0,20
07.04.2008	11:31	07.04.2008	13:53		Repositioning		RWP	0 02:22	2,37
07.04.2008	13:53	07.04.2008	14:05		OBS#L04 deployed in 35 13.0S 72 50.0W		OBS	0 00:12	0,20
07.04.2008	14:05	07.04.2008	16:10		Repositioning		RWP	0 02:05	2,08
07.04.2008	16:10	07.04.2008	16:22		OBS#L06 deployed in 35 05.0S 73 11.9W		OBS	0 00:12	0,20
07.04.2008	16:22	07.04.2008	19:00		Repositioning		RWP	0 02:38	2,63
07.04.2008	19:00	07.04.2008	19:12		OBS#L07 deployed in 35 27.0S 73 20.0W		OBS	0 00:12	0,20
07.04.2008	19:12	07.04.2008	19:57		Repositioning for start of air gun/streamer test		RWP	0 00:45	0,75
07.04.2008	19:57	07.04.2008	21:18		From 35 27.1S 73 20.0W to 35 30.1S 73 18.8W; Air gun & streamer streamed, tested & recovered		AG	0 01:21	1,35
07.04.2008	21:18	07.04.2008	21:42		OBS#1219 deployed in 35 30.64S 73 19.63W		OBS	0 00:24	0,40
07.04.2008	21:42	07.04.2008	21:58		OBS#1218 deployed in 35 30.58S 73 19.92W		OBS	0 00:16	0,27
07.04.2008	21:58	07.04.2008	22:12		OBS#1217 deployed in 35 30.49S 73 20.24W		OBS	0 00:14	0,23
07.04.2008	22:12	07.04.2008	22:32		OBS#1216 deployed in 35 30.29S 73 20.89W		OBS	0 00:20	0,33
07.04.2008	22:32	07.04.2008	22:53		OBS#1215 deployed in 35 29.98S 73 21.90W		OBS	0 00:21	0,35
07.04.2008	22:53	07.04.2008	23:07		OBS#1214 deployed in 35 29.82S 73 22.47W		OBS	0 00:14	0,23
07.04.2008	23:07	07.04.2008	23:24		OBS#1213 deployed in 35 29.58S 73 23.26W		OBS	0 00:17	0,28
07.04.2008	23:24	07.04.2008	23:47		OBS#1201 deployed in 35 30.91S 73 24.32W		OBS	0 00:23	0,38
07.04.2008	23:47	07.04.2008	23:58		OBS#1202 deployed in 35 31.05S 73 23.81W		OBS	0 00:11	0,18
07.04.2008	23:58	08.04.2008	00:15		OBS#1203 deployed in 35 31.2S 73 23.4W		OBS	0 00:17	0,28
08.04.2008	00:15	08.04.2008	01:04		OBS#1204 deployed in 35 31.3S 73 22.9W		OBS	0 00:49	0,82
08.04.2008	01:04	08.04.2008	01:20		OBS#1205 deployed in 35 31.5S 73 22.3W		OBS	0 00:16	0,27
08.04.2008	01:20	08.04.2008	01:27		OBS#1206 deployed in 35 31.5S 73 22.2W		OBS	0 00:07	0,12
08.04.2008	01:27	08.04.2008	01:39		OBS#1207 deployed in 35 31.6S 73 22.0W		OBS	0 00:12	0,20

Appendix 15.8: Timetable

Cruise JC023 Leg b

R.R.S. James Cook

Start		End		All times Local time	Comment	Indicator	dd hh:mm	hours
Date	Time	Date	Time					
08.04.2008	01:39	08.04.2008	01:48	OBS#1208 deployed in 35 31.6S 73 21.8W		OBS	0 00:09	0,15
08.04.2008	01:48	08.04.2008	02:03	OBS#1209 deployed in 35 31.8S 73 21.3W		OBS	0 00:15	0,25
08.04.2008	02:03	08.04.2008	02:19	OBS#1210 deployed in 35 32.0S 73 20.7W		OBS	0 00:16	0,27
08.04.2008	02:19	08.04.2008	02:35	OBS#1211 deployed in 35 32.1S 73 20.2W		OBS	0 00:16	0,27
08.04.2008	02:35	08.04.2008	02:50	OBS#1212 deployed in 35 32.3S 73 19.6W		OBS	0 00:15	0,25
08.04.2008	02:50	08.04.2008	04:05	Securing deck & repositioning to 35 30.3S 73 12.2W		RWP	0 01:15	1,25
08.04.2008	04:05	08.04.2008	05:05	Streaming DTS1		DTS1	0 01:00	1,00
08.04.2008	05:05	08.04.2008	08:17	DTS1 recovered - undergoing technical repair		DTEquip	0 03:12	3,20
08.04.2008	08:17	08.04.2008	09:50	From 35 30.2S 73 12.1W to 35 33.3S 73 14.7W; DTS1, Streamer & Gun array deployed		DTS1	0 01:33	1,55
08.04.2008	09:50	08.04.2008	10:38	To 35 33.0S 73 17.4W; Sol 2/1		DTS1	0 00:48	0,80
08.04.2008	10:38	08.04.2008	12:32	To 35 30.9S 73 24.3W; Eol 2/1		DTS1	0 01:54	1,90
08.04.2008	12:32	08.04.2008	13:13	To 35 32.3S 73 25.0W; Sol 2/2		DTS1	0 00:41	0,68
08.04.2008	13:13	08.04.2008	16:40	To 35 35.0S 73 17.3W; Eol 2/2		DTS1	0 03:27	3,45
08.04.2008	16:40	08.04.2008	19:03	To 35 32.2S 73 17.1W; Sol 2/3		DTS1	0 02:23	2,38
08.04.2008	19:03	08.04.2008	20:53	To 35 30.2S 73 24.0W; Eol 2/3		DTS1	0 01:50	1,83
08.04.2008	20:53	08.04.2008	22:32	To 35 31.6S 73 24.6W; Sol 2/4		DTS1	0 01:39	1,65
08.04.2008	22:32	09.04.2008	01:30	To 35 34.8S 73 13.7W; Eol 2/4		DTS1	0 02:58	2,97
09.04.2008	01:30	09.04.2008	03:28	To 35 31.5S 73 16.7W; Sol 2/5		DTS1	0 01:58	1,97
09.04.2008	03:28	09.04.2008	05:47	To 35 29.1S 73 24.9W; Eol 2/5		DTS1	0 02:19	2,32
09.04.2008	05:47	09.04.2008	08:00	To 35 29.2S 73 21.2W; Sol 2/6		DTS1	0 02:13	2,22
09.04.2008	08:00	09.04.2008	09:30	To (est) 35 33.4S 73 23.0W; Eol 2/6		DTS1	0 01:30	1,50
09.04.2008	09:30	09.04.2008	11:20	To 35 33.7S 73 20.9W; Sol 2/7		DTS1	0 01:50	1,83
09.04.2008	11:20	09.04.2008	12:58	To 35 29.1S 73 18.8W; Eol 2/7		DTS1	0 01:38	1,63
09.04.2008	12:58	09.04.2008	14:36	To 35 25.4S 73 16.9W; All gear recovered & deck secured		DTS1	0 01:38	1,63
09.04.2008	14:36	09.04.2008	18:00	34 55.0S 73 37.6W; In transit to OBS recovery area		RWP	0 03:24	3,40
09.04.2008	18:00	09.04.2008	22:40	To 34 14.9S 74 05.2W; Site of 1 of 4 OBS recoveries		RWP	0 04:40	4,67
09.04.2008	22:40	09.04.2008	23:08	OBS#329 recovered		OBS	0 00:28	0,47
09.04.2008	23:08	10.04.2008	01:07	Repositioning to 34 21.1S 73 45.2W		RWP	0 01:59	1,98
10.04.2008	01:07	10.04.2008	01:34	OBS#324 recovered		OBS	0 00:27	0,45
10.04.2008	01:34	10.04.2008	03:25	Repositioning to 34 26.3S 73 29.3W		RWP	0 01:51	1,85
10.04.2008	03:25	10.04.2008	03:52	OBS#320 recovered		OBS	0 00:27	0,45
10.04.2008	03:52	10.04.2008	07:45	Repositioning to 34 38.0S 72 54.3W		RWP	0 03:53	3,88
10.04.2008	07:45	10.04.2008	13:30	Waiting time; OBS due to auto-release at 1200LT; no show		RWP	0 05:45	5,75
10.04.2008	13:30	10.04.2008	19:15	Transit back to core site; 35 30.7S 73 22.1W; Emergency & L'boat exercise @ 16:15hrs		RWP	0 05:45	5,75
10.04.2008	19:15	10.04.2008	19:53	DP set-up time		RWP	0 00:38	0,63
10.04.2008	19:53	10.04.2008	21:06	Core#7 to 1366m		Core	0 01:13	1,22
10.04.2008	21:06	10.04.2008	21:36	Repositioning to 35 31.3S 73 22.9W		RWP	0 00:30	0,50
10.04.2008	21:36	10.04.2008	22:48	Core#8 to 1242m		Core	0 01:12	1,20
10.04.2008	22:48	10.04.2008	23:30	Repositioning to 35 33.1S 73 20.6W		RWP	0 00:42	0,70
10.04.2008	23:30	11.04.2008	01:00	Core#9 to est 1200m		Core	0 01:30	1,50
11.04.2008	01:00	11.04.2008	02:00	Processing cores & securing deck		RWP	0 01:00	1,00
11.04.2008	02:00	11.04.2008	02:24	Repositioning to 35 30.8S 73 19.2W		RWP	0 00:24	0,40

Appendix 15.8: Timetable

Cruise JC023 Leg b

R.R.S. James Cook

Start		End		Time	All times Local time	Indicator	dd hh:mm	hours
Date	Time	Date	Time					
11.04.2008	02:24	11.04.2008	02:51	02:51	OBS#1219 recovered	OBS	0 00:27	0,45
11.04.2008	02:51	11.04.2008	03:15	03:15	OBS#1218 recovered	OBS	0 00:24	0,40
11.04.2008	03:15	11.04.2008	03:44	03:44	OBS#1217 recovered	OBS	0 00:29	0,48
11.04.2008	03:44	11.04.2008	04:10	04:10	OBS#1216 recovered	OBS	0 00:26	0,43
11.04.2008	04:10	11.04.2008	04:45	04:45	OBS#1215 recovered	OBS	0 00:35	0,58
11.04.2008	04:45	11.04.2008	05:25	05:25	OBS#1214 recovered	OBS	0 00:40	0,67
11.04.2008	05:25	11.04.2008	05:59	05:59	OBS#1213 recovered	OBS	0 00:34	0,57
11.04.2008	05:59	11.04.2008	07:00	07:00	Repositioning to 35 30.3S 73 24.4W	RWP	0 01:01	1,02
11.04.2008	07:00	11.04.2008	07:29	07:29	OBS#1201 recovered	OBS	0 00:29	0,48
11.04.2008	07:29	11.04.2008	07:56	07:56	OBS#1202 recovered	OBS	0 00:27	0,45
11.04.2008	07:56	11.04.2008	08:18	08:18	OBS#1203 recovered	OBS	0 00:22	0,37
11.04.2008	08:18	11.04.2008	08:33	08:33	OBS#1204 recovered	OBS	0 00:15	0,25
11.04.2008	08:33	11.04.2008	08:47	08:47	OBS#1205 recovered	OBS	0 00:14	0,23
11.04.2008	08:47	11.04.2008	09:13	09:13	OBS#1206 recovered	OBS	0 00:26	0,43
11.04.2008	09:13	11.04.2008	09:23	09:23	OBS#1207 recovered	OBS	0 00:10	0,17
11.04.2008	09:23	11.04.2008	09:32	09:32	OBS#1208 recovered	OBS	0 00:09	0,15
11.04.2008	09:32	11.04.2008	09:52	09:52	OBS#1209 recovered	OBS	0 00:20	0,33
11.04.2008	09:52	11.04.2008	10:07	10:07	OBS#1210 recovered	OBS	0 00:15	0,25
11.04.2008	10:07	11.04.2008	10:23	10:23	OBS#1211 recovered	OBS	0 00:16	0,27
11.04.2008	10:23	11.04.2008	11:53	11:53	Searching for OBS#1212 (accidentally triggered 5 hrs earlier)	RWP	0 01:30	1,50
11.04.2008	11:53	11.04.2008	12:45	12:45	OBS#1212 recovered; securing deck; v/l position 35 27.1S 73 19.1W	OBS	0 00:52	0,87
11.04.2008	12:45	11.04.2008	20:00	20:00	Repositioning to 3rd area of interest; 36 21.6S 73 42.2W	RWP	0 07:15	7,25
11.04.2008	20:00	11.04.2008	20:35	20:35	OBS#1101 deployed in 36 21.55S 73 42.18W	OBS	0 00:35	0,58
11.04.2008	20:35	11.04.2008	20:54	20:54	OBS#1102 deployed in 36 21.84S 73 42.20W	OBS	0 00:19	0,32
11.04.2008	20:54	11.04.2008	21:11	21:11	OBS#1103 deployed in 36 22.06S 73 42.17W	OBS	0 00:17	0,28
11.04.2008	21:11	11.04.2008	21:21	21:21	OBS#1104 deployed in 36 22.29S 73 42.18W	OBS	0 00:10	0,17
11.04.2008	21:21	11.04.2008	21:30	21:30	OBS#1105 deployed in 36 22.54S 73 42.18W	OBS	0 00:09	0,15
11.04.2008	21:30	11.04.2008	21:45	21:45	OBS#1106 deployed in 36 23.09S 73 42.19W	OBS	0 00:15	0,25
11.04.2008	21:45	11.04.2008	22:00	22:00	OBS#1107 deployed in 36 23.66S 73 42.20W	OBS	0 00:15	0,25
11.04.2008	22:00	11.04.2008	22:14	22:14	OBS#1108 deployed in 36 24.20S 73 42.21W	OBS	0 00:14	0,23
11.04.2008	22:14	11.04.2008	22:26	22:26	OBS#1109 deployed in 36 24.72S 73 42.21W	OBS	0 00:12	0,20
11.04.2008	22:26	11.04.2008	22:35	22:35	OBS#1110 deployed in 36 24.97S 73 42.20W	OBS	0 00:09	0,15
11.04.2008	22:35	11.04.2008	22:44	22:44	OBS#1111 deployed in 36 25.13S 73 42.22W	OBS	0 00:09	0,15
11.04.2008	22:44	11.04.2008	22:55	22:55	OBS#1112 deployed in 36 25.27S 73 42.22W	OBS	0 00:11	0,18
11.04.2008	22:55	11.04.2008	23:05	23:05	OBS#1113 deployed in 36 25.53S 73 42.22W	OBS	0 00:10	0,17
11.04.2008	23:05	11.04.2008	23:16	23:16	OBS#1114 deployed in 36 25.88S 73 42.22W	OBS	0 00:11	0,18
11.04.2008	23:16	11.04.2008	23:25	23:25	OBS#1115 deployed in 36 26.19S 73 42.21W	OBS	0 00:09	0,15
11.04.2008	23:25	11.04.2008	23:35	23:35	OBS#1116 deployed in 36 26.46S 73 42.21W	OBS	0 00:10	0,17
11.04.2008	23:35	11.04.2008	23:43	23:43	OBS#1117 deployed in 36 26.64S 73 42.22W	OBS	0 00:08	0,13
11.04.2008	23:43	11.04.2008	23:50	23:50	OBS#1118 deployed in 36 26.79S 73 42.22W	OBS	0 00:07	0,12
11.04.2008	23:50	11.04.2008	23:57	23:57	OBS#1119 deployed in 36 27.95S 73 42.22W	OBS	0 00:07	0,12
11.04.2008	23:57	12.04.2008	02:05	02:05	Repositioning to 36 12.6S 73 42.2W for streaming ss sonar/seismic gear	RWP	0 02:08	2,13

Timetable of Events

Appendix 15.8: Timetable

Cruise JC023 Leg b

R.R.S. James Cook

Start		End		Time	All times Local time	Comment	Indicator	dd hh:mm	hours
Date	Time	Date	Time						
12.04.2008	02:05	12.04.2008	03:28	To 36 15.7S 73 42.2W;	DTS1, Streamer, Air Gun boom & USBL pole deployed; 3 guns firing	DTS1	0 01:23	1,38	
12.04.2008	03:28	12.04.2008	04:30	To 36 18.7S 73 42.1W; Sol. 3/1		DTS1	0 01:02	1,03	
12.04.2008	04:30	12.04.2008	09:36	To 36 34.8S 73 42.3W; Eol. 3/1; commence turn to port		DTS1	0 05:06	5,10	
12.04.2008	09:36	12.04.2008	10:47	To 36 34.5S 73 39.3W; Sol. 3/2		DTS1	0 01:11	1,18	
12.04.2008	10:47	12.04.2008	16:15	To 36 17.8S 73 39.2W; Eol. 3/2		DTS1	0 05:28	5,47	
12.04.2008	16:15	12.04.2008	17:48	To 36 18.6S 73 43.1W; Sol. 3/3 (guns stopped due to whale presence then soft re-started after 50 minutes)		DTS1	0 01:33	1,55	
12.04.2008	17:48	12.04.2008	23:24	To 36 35.0S 73 43.2W; Eol. 3/3 (line included 30 min deviation to avoid small fishing v/l)		DTS1	0 05:36	5,60	
12.04.2008	23:24	13.04.2008	00:55	To 36 33.6S 73 40.3W; Sol. 3/4		DTS1	0 01:31	1,52	
13.04.2008	00:55	13.04.2008	06:01	To 36 17.8S 73 40.2W; Eol. 3/4		DTS1	0 05:06	5,10	
13.04.2008	06:01	13.04.2008	07:42	To 36 18.6S 73 43.0W; Sol. 3/5		DTS1	0 01:41	1,68	
13.04.2008	07:42	13.04.2008	13:25	To 36 35.2S 73 44.1W; Eol. 3/5		DTS1	0 05:43	5,72	
13.04.2008	13:25	13.04.2008	14:45	To 36 33.6S 73 41.3W; Sol. 3/6		DTS1	0 01:20	1,33	
13.04.2008	14:45	13.04.2008	19:48	To 36 18.1S 73 41.2W; Eol. 3/6; guns stopped; commence recovery of gear		DTS1	0 05:03	5,05	
13.04.2008	19:48	13.04.2008	21:30	To 36 15.5S 73 42.9W; Gun array, streamer & DTS1 recovered; deck secure		DTS1	0 01:42	1,70	
13.04.2008	21:30	13.04.2008	22:30	Repositioning towards OBS recovery location		RWP	0 01:00	1,00	
13.04.2008	22:30	14.04.2008	12:00	V/l position 36 21.2S 73 42.0W; Hove-to; Weather downtime; Wind SxW 30 knots at end of period; rough sea & lengthening l		DTWx	0 13:30	13,50	
14.04.2008	12:00	14.04.2008	20:36	V/l position 36 21.16S 73 42.16W; Hove-to; Wx d'time; Wind SxW 30 knots at end of period; rough sea & lengthening l		DTWx	0 08:36	8,60	
14.04.2008	20:36	14.04.2008	20:57	OBS#1101 recovered		OBS	0 00:21	0,35	
14.04.2008	20:57	14.04.2008	21:26	OBS#1102 recovered		OBS	0 00:29	0,48	
14.04.2008	21:26	14.04.2008	22:01	OBS#1103 recovered		OBS	0 00:35	0,58	
14.04.2008	22:01	14.04.2008	22:27	OBS#1104 recovered		OBS	0 00:26	0,43	
14.04.2008	22:27	14.04.2008	22:49	OBS#1105 recovered		OBS	0 00:22	0,37	
14.04.2008	22:49	14.04.2008	23:11	OBS#1106 recovered		OBS	0 00:22	0,37	
14.04.2008	23:11	14.04.2008	23:33	OBS#1107 recovered		OBS	0 00:22	0,37	
14.04.2008	23:33	14.04.2008	23:56	OBS#1108 recovered		OBS	0 00:23	0,38	
14.04.2008	23:56	15.04.2008	00:42	OBS#1109 recovered		OBS	0 00:46	0,77	
15.04.2008	00:42	15.04.2008	01:08	OBS#1110 recovered		OBS	0 00:26	0,43	
15.04.2008	01:08	15.04.2008	01:27	OBS#1111 recovered		OBS	0 00:19	0,32	
15.04.2008	01:27	15.04.2008	01:51	OBS#1112 recovered		OBS	0 00:24	0,40	
15.04.2008	01:51	15.04.2008	02:09	OBS#1113 recovered		OBS	0 00:18	0,30	
15.04.2008	02:09	15.04.2008	02:32	OBS#1114 recovered		OBS	0 00:23	0,38	
15.04.2008	02:32	15.04.2008	02:53	OBS#1115 recovered		OBS	0 00:21	0,35	
15.04.2008	02:53	15.04.2008	03:14	OBS#1116 recovered		OBS	0 00:21	0,35	
15.04.2008	03:14	15.04.2008	03:37	OBS#1117 recovered		OBS	0 00:23	0,38	
15.04.2008	03:37	15.04.2008	04:01	OBS#1118 recovered		OBS	0 00:24	0,40	
15.04.2008	04:01	15.04.2008	04:32	OBS#1119 recovered; V/l position 36 26.8S 73 42.1W		OBS	0 00:31	0,52	
15.04.2008	04:32	15.04.2008	11:06	In transit to coring site - 35 33.26S 73 55.19W		RWP	0 06:34	6,57	
15.04.2008	11:06	15.04.2008	14:41	Coring to 5060m; 5.8t 'pull-out'		Core	0 03:35	3,58	
15.04.2008	14:41	15.04.2008	15:08	Repositioning to 35 33.1S 73 54.5W		RWP	0 00:27	0,45	
15.04.2008	15:08	15.04.2008	19:00	Coring to 5068m; 7.0t 'pull-out'		Core	0 03:52	3,87	
15.04.2008	19:00	15.04.2008	20:15	Repositioning to 35 35.19S 73 44.09W		RWP	0 01:15	1,25	
15.04.2008	20:15	16.04.2008	00:09	Coring to 4468m; 5.6t 'pull-out'		Core	0 03:54	3,90	

Timetable of Events

Appendix 15.8: Timetable

Cruise JC023 Leg b

R.R.S. James Cook

Start		End		Time	All times Local time	Indicator	dd hh:mm	hours
Date	Time	Date	Time					
16.04.2008	00:09	16.04.2008	00:44	00:44	Repositioning to 35 37.8S 73 43.0W	RWP	0 00:35	0,58
16.04.2008	00:44	16.04.2008	04:50	04:50	Coring to 3945m	Core	0 04:06	4,10
16.04.2008	04:50	16.04.2008	13:25	13:25	In transit northward to 34 13.9S 73 12.8W	RWP	0 08:35	8,58
16.04.2008	13:25	16.04.2008	14:02	14:02	Single air gun & streamer deployed - commence firing @ 34 15.3S 73 12.8W	AG	0 00:37	0,62
16.04.2008	14:02	16.04.2008	19:30	19:30	Complete sequence of air gun lines @ 34 16.3S 73 07.1W	AG	0 05:28	5,47
16.04.2008	19:30	16.04.2008	19:50	19:50	Air gun & streamer recovered	AG	0 00:20	0,33
16.04.2008	19:50	16.04.2008	20:30	20:30	Repositioning to 34 16.0S 73 07.1W	RWP	0 00:40	0,67
16.04.2008	20:30	16.04.2008	22:54	22:54	Swath/bathy to 34 05.3S 73 14.1W; A/c to 096 degs; Speed 5 knots	Swath	0 02:24	2,40
16.04.2008	22:54	17.04.2008	01:24	01:24	Swath/bathy to 34 06.6S 72 59.7W; A/c to 073 degs	Swath	0 02:30	2,50
17.04.2008	01:24	17.04.2008	02:48	02:48	Swath/bathy to 34 04.5S 72 51.5W; A/c to 092 degs	Swath	0 01:24	1,40
17.04.2008	02:48	17.04.2008	04:55	04:55	Swath/bathy to 34 05.0S 72 38.9W; A/c to 144 degs	Swath	0 02:07	2,12
17.04.2008	04:55	17.04.2008	06:06	06:06	Swath/bathy to 34 10.4S 72 34.1W; A/c to 030 degs	Swath	0 01:11	1,18
17.04.2008	06:06	17.04.2008	07:33	07:33	Swath/bathy to 34 03.9S 72 29.8W; A/c to 266 degs	Swath	0 01:27	1,45
17.04.2008	07:33	17.04.2008	08:00	08:00	Swath/bathy to 34 04.0S 72 32.1W; A/c to 207 degs	Swath	0 00:27	0,45
17.04.2008	08:00	17.04.2008	08:41	08:41	Swath/bathy to 34 06.8S 72 34.0W; A/c to 338 degs	Swath	0 00:41	0,68
17.04.2008	08:41	17.04.2008	09:54	09:54	Swath/bathy to 34 01.3S 72 36.6W; A/c to 089 degs	Swath	0 01:13	1,22
17.04.2008	09:54	17.04.2008	12:00	12:00	Swath/bathy to 34 01.0S 72 23.5W; A/c to 204 degs	Swath	0 02:06	2,10
17.04.2008	12:00	17.04.2008	12:44	12:44	Swath/bathy to 34 03.4S 72 24.6W; A/c to 209 degs	Swath	0 00:44	0,73
17.04.2008	12:44	17.04.2008	14:24	14:24	Swath/bathy to 34 10.8S 72 29.5W; A/c to 134 degs	Swath	0 01:40	1,67
17.04.2008	14:24	17.04.2008	15:17	15:17	Swath/bathy to 34 14.1S 72 25.7W; A/c to 024 degs	Swath	0 00:53	0,88
17.04.2008	15:17	17.04.2008	18:05	18:05	Swath/bathy to 34 01.0S 72 18.2W; A/c to 080 degs	Swath	0 02:48	2,80
17.04.2008	18:05	17.04.2008	19:13	19:13	Swath/bathy to 33 59.9S 72 11.3W; A/c to 018 degs	Swath	0 01:08	1,13
17.04.2008	19:13	17.04.2008	20:00	20:00	Swath/bathy to 33 55.9S 72 09.7W; Speed incr to 7 knots	Swath	0 00:47	0,78
17.04.2008	20:00	17.04.2008	21:13	21:13	Swath/bathy to 33 48.0S 72 06.8W; A/c to 022 degs	Swath	0 01:13	1,22
17.04.2008	21:13	17.04.2008	23:09	23:09	Swath/bathy to 33 35.3S 72 00.6W; A/c to 037 degs	Swath	0 01:56	1,93
17.04.2008	23:09	18.04.2008	00:19	00:19	Swath/bathy to 33 29.0S 71 55.0W; A/c to 014 degs	Swath	0 01:10	1,17
18.04.2008	00:19	18.04.2008	02:00	02:00	Swath/bathy to 33 17.7S 71 51.6W; A/c to 325 degs	Swath	0 01:41	1,68
18.04.2008	02:00	18.04.2008	02:46	02:46	Swath/bathy to 33 14.2S 71 54.6W; A/c to 009 degs	Swath	0 00:46	0,77
18.04.2008	02:46	18.04.2008	04:56	04:56	Plata Curumilla 124 deg x 7.9nm; A/c to 072 degs	Swath	0 02:10	2,17
18.04.2008	04:56	18.04.2008	06:00	06:00	Plata Curumilla 169 deg x 6.6nm; End of science	Swath	0 01:04	1,07
18.04.2008	06:00	18.04.2008	07:12	07:12	Plata Angeles brng 166 deg x 3.3nm; End of Passage	Pass	0 01:12	1,20
18.04.2008	07:12	18.04.2008	07:24	07:24	ME, thruster & string gear tested & satis, for'd & stbd consoles	Pass	0 00:12	0,20
18.04.2008	07:24	18.04.2008	08:01	08:01	V/I to 0.7 nm NNE of entrance; Pob	Pass	0 00:37	0,62
18.04.2008	08:01	18.04.2008	08:19	08:19	V/I entering Valparaiso harbour	Pass	0 00:18	0,30
18.04.2008	08:19	18.04.2008	08:33	08:33	Manoeuvring alongside; 1st line	Pass	0 00:14	0,23
18.04.2008	08:33	18.04.2008	08:42	08:42	All fast 3&2 for'd, 4&2 aft; RFWE; Pilot away	Pass	0 00:09	0,15
								563,85

Timetable of Events

Appendix 15.8: Timetable

Aggregated Hours for each Activity

Indicator	Indicator	Indicator	Indicator	Indicator	Indicator	Indicator	Indicator	Indicator	Indicator	Indicator	Indicator	Indicator	Indicator
Mob	Port	Pass	Core	OBS	AG	DTS1	RWP	Swath	DTWx	DTShip	DTEquip	DTOther	
10,00	15,03	17,65	38,52	81,38	20,12	133,08	150,95	61,77	22,10	9,05	4,20	0,00	563,85

Indicator Legend

- Mob** Mobilising
- Port** Bunkering etc
- Pass** Pilotage & Passage
- DTS1** Deep Tow Side Scan
- OBS** Ocean Bottom Seismographs
- AG** Air guns
- Anc** Anchorage
- Swath** Swath
- Core** Core
- RWP** Reposition/Waiting/Preparation
- DTWx** Downtime weather
- DTShip** Downtime ship systems
- DTEquip** Downtime scientific systems
- DTOther** Downtime Other (Medical etc)

JC023b (Time) - Hours, %

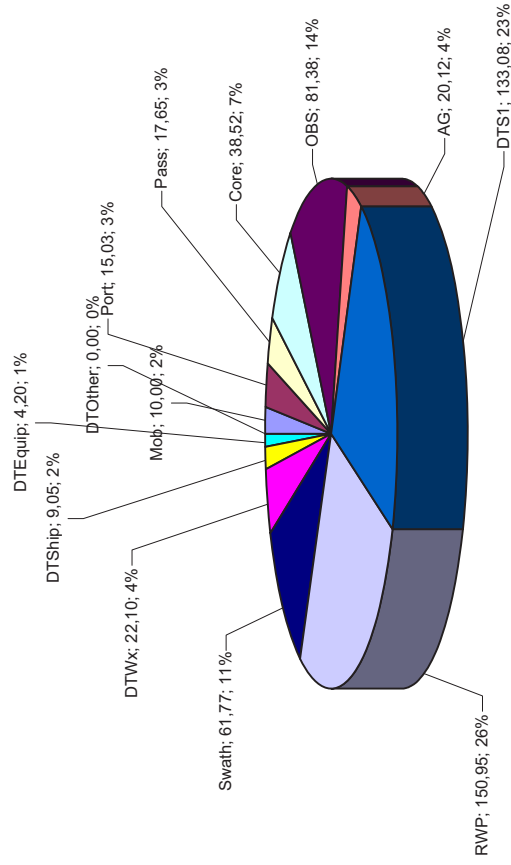

IFM-GEOMAR Reports

- | No. | Title |
|-----|--|
| 1 | RV Sonne Fahrtbericht / Cruise Report SO 176 & 179 MERAMEX I & II (Merapi Amphibious Experiment) 18.05.-01.06.04 & 16.09.-07.10.04. Ed. by Heidrun Kopp & Ernst R. Flueh, 2004, 206 pp.
In English |
| 2 | RV Sonne Fahrtbericht / Cruise Report SO 181 TIPTEQ (from The Incoming Plate to mega Thrust EarthQuakes) 06.12.2004.-26.02.2005. Ed. by Ernst R. Flueh & Ingo Grevemeyer, 2005, 533 pp.
In English |
| 3 | RV Poseidon Fahrtbericht / Cruise Report POS 316 Carbonate Mounds and Aphotic Corals in the NE-Atlantic 03.08.-17.08.2004. Ed. by Olaf Pfannkuche & Christine Utecht, 2005, 64 pp.
In English |
| 4 | RV Sonne Fahrtbericht / Cruise Report SO 177 - (Sino-German Cooperative Project, South China Sea: Distribution, Formation and Effect of Methane & Gas Hydrate on the Environment) 02.06.-20.07.2004. Ed. by Erwin Suess, Yongyang Huang, Nengyou Wu, Xiqiu Han & Xin Su, 2005, 154 pp.
In English and Chinese |
| 5 | RV Sonne Fahrtbericht / Cruise Report SO 186 – GITEWS (German Indonesian Tsunami Early Warning System 28.10.-13.1.2005 & 15.11.-28.11.2005 & 07.01.-20.01.2006. Ed. by Ernst R. Flueh, Tilo Schoene & Wilhelm Weinrebe, 2006, 169 pp.
In English |
| 6 | RV Sonne Fahrtbericht / Cruise Report SO 186 -3 – SeaCause II, 26.02.-16.03.2006. Ed. by Heidrun Kopp & Ernst R. Flueh, 2006, 174 pp.
In English |
| 7 | RV Meteor, Fahrtbericht / Cruise Report M67/1 CHILE-MARGIN-SURVEY 20.02.-13.03.2006. Ed. by Wilhelm Weinrebe und Silke Schenk, 2006, 112 pp.
In English |
| 8 | RV Sonne Fahrtbericht / Cruise Report SO 190 - SINDBAD (Seismic and Geoacoustic Investigations Along The Sunda-Banda Arc Transition) 10.11.2006 - 24.12.2006. Ed. by Heidrun Kopp & Ernst R. Flueh, 2006, 193 pp.
In English |
| 9 | RV Sonne Fahrtbericht / Cruise Report SO 191 - New Vents "Puaretanga Hou" 11.01. - 23.03.2007. Ed. by Jörg Bialas, Jens Greinert, Peter Linke, Olaf Pfannkuche, 2007, 190 pp.
In English |

- 10 FS ALKOR Fahrtbericht / Cruise Report AL 275 - Geobiological investigations and sampling of aphotic coral reef ecosystems in the NE-Skagerrak, 24.03. - 30.03.2006, Andres Rüggeberg & Armin Form, 39 pp.
In English
- 11 FS Sonne / Fahrtbericht / Cruise Report SO 192-1: MANGO: Marine Geoscientific Investigations on the Input and Output of the Kermadec Subduction Zone, 24.03. - 22.04.2007, Ernst Flüh & Heidrun Kopp, 127 pp.
In English
- 12 FS Maria S. Merian / Fahrtbericht / Cruise Report MSM 04-2: Seismic Wide-Angle Profiles, Fort-de-France – Fort-de-France, 03.01. - 19.01.2007, Ernst Flüh, 45 pp.
In English
- 13 FS Sonne / Fahrtbericht / Cruise Report SO 193: MANIHIKI Temporal, Spatial, and Tectonic Evolution of Oceanic Plateaus, Suva/Fiji – Apia/Samoa 19.05. - 30.06.2007, Reinhard Werner and Folkmar Hauff, 201 pp.
In English
- 14 FS Sonne / Fahrtbericht / Cruise Report SO195: TOTAL TONGA Thrust earthquake Asperity at Louisville Ridge, Suva/Fiji – Suva/Fiji 07.01. - 16.02.2008, Ingo Grevemeyer & Ernst R. Flüh, xx pp.
In English
- 15 RV Poseidon Fahrtbericht / Cruise Report P362-2: West Nile Delta Mud Volcanoes, Piräus – Heraklion 09.02. - 25.02.2008, Thomas Feseker, 63 pp.
In English
- 16 RV Poseidon Fahrtbericht / Cruise Report P347: Mauritanian Upwelling and Mixing Process Study (MUMP), Las-Palmas - Las Palmas, 18.01. - 05.02.2007, Marcus Dengler et al., 34 pp.
In English
- 17 FS Maria S. Merian Fahrtbericht / Cruise Report MSM 04-1: Meridional Overturning Variability Experiment (MOVE 2006), Fort de France – Fort de France, 02.12. - 21.12.2006, Thomas J. Müller, 41 pp.
In English
- 18 FS Poseidon Fahrtbericht /Cruise Report P348: SOPRAN: Mauritanian Upwelling Study 2007, Las Palmas - Las Palmas, 08.02. - 26.02.2007, Hermann W. Bange, 42 pp.
In English
- 19 R/V L'ATALANTE Fahrtbericht / Cruise Report IFM-GEOMAR-4: Circulation and Oxygen Distribution in the Tropical Atlantic, Mindelo/Cape Verde - Mindelo/Cape Verde, 23.02. - 15. 03.2008, Peter Brandt, 65 pp.
In English



IFM-GEOMAR

Leibniz-Institut für Meereswissenschaften
an der Universität Kiel

Das Leibniz-Institut für Meereswissenschaften
ist ein Institut der Wissenschaftsgemeinschaft
Gottfried Wilhelm Leibniz (WGL)

The Leibniz-Institute of Marine Sciences is a
member of the Leibniz Association
(Wissenschaftsgemeinschaft Gottfried
Wilhelm Leibniz).

Leibniz-Institut für Meereswissenschaften / Leibniz-Institute of Marine Sciences

IFM-GEOMAR
Dienstgebäude Westufer / West Shore Building
Düsternbrooker Weg 20
D-24105 Kiel
Germany

Leibniz-Institut für Meereswissenschaften / Leibniz-Institute of Marine Sciences

IFM-GEOMAR
Dienstgebäude Ostufer / East Shore Building
Wischhofstr. 1-3
D-24148 Kiel
Germany

Tel.: ++49 431 600-0
Fax: ++49 431 600-2805
www.ifm-geomar.de