



**National
Oceanography Centre**
NATURAL ENVIRONMENT RESEARCH COUNCIL

National Oceanography Centre

Cruise Report No. 51

RRS James Clark Ross JR16006

30 June – 8 Aug 2017

The Changing Arctic Ocean Cruise JR16006

Principal Scientist

J Hopkins

2018

National Oceanography Centre
Joseph Proudman Building
6 Brownlow Street
Liverpool
L3 5DA
UK

Tel: +44 (0)151 795 4859
Email: j.hopkins@noc.ac.uk

DOCUMENT DATA SHEET

AUTHOR HOPKINS, J et al	PUBLICATION DATE 2018
TITLE RRS <i>James Clark Ross</i> JR16006, 30 June-8 Aug 2017. The Changing Arctic Ocean Cruise JR16006.	
REFERENCE Liverpool, UK: National Oceanography Centre, Liverpool, 153pp. (National Oceanography Centre Cruise Report, No. 51)	
ABSTRACT JR16006 was the first in a series of cruises to the Barents Sea funded by the Natural Environment Research Councils' Changing Arctic Ocean Research Programme. The overarching aim of the cruise was to collect a suite of pelagic and benthic samples across water mass and sea-ice gradients to enable: <ul style="list-style-type: none">• Determination of dissolved and particulate organic material and inorganic nutrients• Estimation of water column primary production, phytoplankton community composition, photo-physiology and biomass• Foodweb tracer analysis using stable isotopes techniques• A mapping of the baseline 'isoscape'• Determination of the total zooplankton community and lipid content• Determination of the sediment and pore water geochemistry - amount of organic material and its degradation and interactions with biological processes (e.g., bioturbation, microbial community structures)• Determination of the structure, function (e.g. nitrogen cycling, bioturbation), diversity and reproductive state of benthic communities (from epifauna to meiofauna)• Determination of water column and seabed microbial community and diversity <p>This report describes the sampling and data collection across a series of 18 key stations in the Barents Sea during July and August 2017 on board the RRS <i>James Clark Ross</i>.</p>	
KEYWORDS	
ISSUING ORGANISATION National Oceanography Centre University of Southampton Waterfront Campus European Way Southampton SO14 3ZH UK Tel: +44(0)23 80596116 Email: nol@noc.soton.ac.uk <i>A pdf of this report is available for download at: http://eprints.soton.ac.uk</i>	

This page is intentionally left blank

Changing Arctic Ocean JR16006 Cruise Report

Dr. Jo Hopkins (Principal Scientist)
National Oceanography Centre, Liverpool

RRS James Clark Ross Cruise JR16006
30th June – 8th August 2017



Acknowledgements

We are grateful to all the officers and crew of the RRS James Clark Ross for their efforts in making this cruise a success. We also thank our cruise manager Jeremy Evans for his support during the cruise planning and mobilization.

This page is intentionally left blank

Table of Contents

1. Introduction and cruise summary.....	6
1.1 Background and scientific motivation.....	6
1.2 Scientific and ships personnel.....	7
1.3 Cruise diary.....	9
1.4 Station locations.....	18
2. Hydrography, physics and computing.....	20
2.1 Computing.....	20
2.2 CTD data.....	22
2.3 Underway navigation, sea surface hydrography and meteorology.....	46
2.4 Lowered ADCP.....	54
2.5 Vessel-Mounted Acoustic Doppler Current Profiler (VMADCP).....	56
3. Glider deployment.....	65
4. Oxygen.....	69
5. Water column biogeochemistry.....	74
5.1 Nutrients and isotopes.....	74
5.2 Macronutrients.....	82
5.3 POC, DOC and DOP.....	86
6. Primary Production.....	87
6.1 Photosynthesis-irradiance incubations and photophysiology.....	87
6.2 Primary production deck incubations.....	90
7. Phytoplankton and microbial community.....	93
7.1 Optical properties and pigments.....	93
7.2 Coccolithophore abundance and taxonomy.....	97
7.3 Flowcytometry and taxonomy.....	100
7.4 Fatty acids and pigments.....	102
7.5 Phytoplankton/microbial ID and community structure.....	106
8. Zooplankton community.....	108
8.1 Total zooplankton community and lipid content.....	108
8.2 ¹⁵ N and ¹⁵ N-AA in <i>Calanus</i> copepods.....	112
9. Sediment and porewater geochemistry.....	116
9.1 Organic and inorganic geochemistry.....	116
9.2 Pore water nutrient analysis.....	132
10. Benthic fauna.....	135
10.1 Community structure and biodiversity.....	135
10.2 Reproductive state.....	143
10.3 Microbial community and diversity.....	146
11. Benthic community function.....	148
11.1 Nitrogen cycling.....	148
11.2 Bioturbation.....	150
12. Appendix A - Cruise Event Log.....	153

1. Introduction and cruise summary

1.1 Background and scientific motivation

The Arctic environment is changing, rapidly. Sea ice concentrations and ice extent are decreasing, the ocean and atmosphere are warming, fresh water discharges are increasing and stratification, mixing and circulation regimes are altering. All these changes impact the Arctic Oceans ecosystem, from the sea surface to the sea floor. For example, longer and more expansive open water periods influence the timing and longevity of phytoplankton blooms which are important for sustaining life at all trophic levels, from tiny zooplankton in the water column and microscopic benthic fauna, right up to the whales and seals at the top of the food chain. Changes in the light and nutrient regimes have consequences for the amount and quality of particulate and dissolved organic matter, the cycling of nutrients in the water and sediments, and consequently the biodiversity of life that can be supported. The migration and grazing of zooplankton, behaviours that transfer huge quantities of carbon into the ocean interior, may also be affected.

In 2017 the Natural Environment Research Council (NERC) started an investment of £16 million in its 5-year Changing Arctic Ocean Programme (www.changing-arctic-ocean.ac.uk). The overarching aim of the programme is to better understand and quantify the impacts of climate change on Arctic ecosystems. The findings will ultimately inform our conservation and management strategies of polar regions. Four large projects were initially funded: ARISE (led by Claire Mahaffey, Uni. Liverpool), Arctic PRIZE (led by Finlo Cottier, SAMS), ChAOS (led by Christian März, Uni. Leeds) and DIAPOD (led by David Pond, SAMS).

JR16006 was the first in a series of Changing Arctic Ocean cruises to the Barents Sea in support of all four projects. The overarching aim of the cruise was to collect a suite of pelagic and benthic samples across water mass (Atlantic to Arctic) and sea-ice gradients to enable:

- Determination of dissolved and particulate organic material and inorganic nutrients
- Estimation of water column primary production, phytoplankton community composition, photo-physiology and biomass
- Foodweb tracer analysis using stable isotopes techniques
- A mapping of the baseline ‘isoscape’
- Determination of the total zooplankton community and lipid content
- Determination of the sediment and pore water geochemistry - amount of organic material and its degradation and interactions with biological processes (e.g., bioturbation, microbial community structures)
- Determination of the structure, function (e.g. nitrogen cycling, bioturbation), diversity and reproductive state of benthic communities (from epifauna to meiofauna)
- Determination of water column and seabed microbial community and diversity

All of the 18 stations (B1- B18) identified pre-cruise were sampled by the ARISE, PRIZE and DIAPOD projects. The ChAOS project conducted extensive sediment and benthic fauna sampling at 6 of these stations (B3, B13-B17).

1.2 Scientific and ships personnel

Scientific personnel

Jo Hopkins	National Oceanography Centre	ARISE (PSO)
Louisa Norman	University of Liverpool	ARISE
Camille de la Vega	University of Liverpool	ARISE
Celeste Kellock	University of Edinburgh	ARISE
Christian Maerz	University of Leeds	ChAOS
Allyson Tessin	University of Leeds	ChAOS
Johan Faust	University of Leeds	ChAOS
Dave Barnes	British Antarctic Survey	ChAOS
Laura Grange	University of Southampton	ChAOS
Dan Wohlgemuth	University of Southampton	ChAOS
Joana Nunes	Plymouth Marine Laboratory	ChAOS
Steve Widdicombe	Plymouth Marine Laboratory	ChAOS
Mark Stevenson	University of Newcastle	ChAOS
Sian Henley	University of Edinburgh	ChAOS/PRIZE
Heather Bouman	University of Oxford	PRIZE
Andrew Orkney	University of Oxford	PRIZE
Timothy Brand	Scottish Association for Marine Science	PRIZE
Estelle Dumont	Scottish Association for Marine Science	PRIZE
Elaine Mitchel	Scottish Association for Marine Science	PRIZE
Marie Porter	Scottish Association for Marine Science	PRIZE
Emily Venables	Scottish Association for Marine Science	PRIZE
Sarah Reed	Scottish Association for Marine Science	DIAPOD
Joana Beja	British Oceanographic Data Centre	BODC

Engineering and IT personnel

Alan Sherring	National Marine Facilities	NMF
John Wynar	National Marine Facilities	NMF
Richard Phipps	National Marine Facilities	NMF
Billy Platt	National Marine Facilities	NMF
William Clark	British Antarctic Survey	AME
Peter Lens	British Antarctic Survey	IT

Ships Crew

Timothy Page	Master
Annalaara Kirkaldy-Willis	Chief Officer
Dominik Müller-Tolk	2 nd Officer
Robert Bellis	3 rd Officer
Matthew Chapman	3 rd Officer
Michael Gloistein	ETO Comms
Gert Behrmann	Chief Engineer
Chris Mannion	2 nd Engineer
Amanda Little	3 rd Engineer
Euan Murry	4 th Engineer
Gareth Wale	Deck Engineer
Stephen Amner	ETO
Richard Turner	Purser

Helen Jones	Doctor
David Peck	Bosun/Sci'Ops
Martin Bowen	Bosun
George Dale	Bosun's Mate
Sheldon Smith	Seaman
Sam English	Seaman
Graham Waylett	Seaman
Alan Howard	Seaman
Francisco Hernandez	Seaman
Glydor Henry	Motorman
John Roddham	Motorman
John Liddy	Chief Cook
Stephen Williams	2 nd Cook
Lee Jones	Senior Steward
Nick Greenwood	Steward
Graham Raworth	Steward
Paula Munoz Garcia	Steward

1.3 Cruise diary

The following table provides a summary of the events that took place each day on the ship. ‘*Enn*’ (e.g. E21) refers to each deployment/activities unique event number. A full set of times and positions for each event can be found in the Event Log available from BODC.

Wind direction is FROM, i.e. southerly wind is a wind blowing from the south towards the north

Date	Weather/Ice	Activities
26/06/2017 Day 177	Warm and sunny	Loading of NMF equipment and containers
27/06/2017 Day 178	Raining and overcast	Start loading science equipment and lab setup
28/06/2017 Day 179	Raining and overcast	Continue loading science equipment and lab setup
29/06/2017 Day 180	Overcast but warm and dry	11:00 BST Tour and interview with Luke from BBC Radio Solent 14:00 BST Tour and interview with ...? The Times 16:00 BST Safety Brief with science party sailing from Southampton First night onboard
30/06/2017 Day 181	12 knot winds Warm (19°C) Sea state 3-4	10:30 BST Muster station and lifeboat drills 16:00 BST Pilot onboard and leave Empress dock 18:00 BST Pilot off - heading past Isle of Wight <u>ALL TIMES NOW GMT IN DIARY</u> 18:18 <u>GMT</u> Underway pumps and Oceanlogger on. Salt sampling started.
01/07/2017 Day 182	10:00 GMT 20 knots winds Sea state 5 16°C airtemp 17:00 GMT 10 knots N winds Sea state 3	06:00 Rounding corner of English Channel and into the North Sea Data management planning Assessing ice maps Finding our sea legs Underway salinity sampling started Ships time switches to Norwegian local time (GMT + 2)
02/07/2017 Day 183	08:00 22 knots wind Sea state 4-5 14°C air temp Pressure 1013.5 hPa	07:15 VMADCP switched on 08:00 JCR heading north through the N. Sea. Crossing the eastern tail of Dogger Bank and heading through the oil and gas fields (Latitude approx. 55° 14.6N) 12:00 Science meeting to discuss data management, station and site naming, activity leads, communication protocols

03/07/2017 Day 184	07:00 8 knot S wind Pressure 1008 hPa (dropping) Air temp 12°C Overcast and slight drizzle Sea state 2-3	07:00 heading north along the western coast of Norway (59° 06'N, 4° 10'E). Shetland to the west. 08:30 Fire Muster drill and video 11:00 Meeting with Captain and crew to discuss science plans
04/07/2017 Day 185	17:00 8-9 knots NW wind Sea state 3 Pressure 1017 hPa Warm with some cloud	07:00 Heading north along the Norwegian coast. Passing Alesund and Storfjorden to the east and The Faroe Isl. to the west. Latitude 62.5°N. Crossed over part of the Storegga slide
05/07/2017 Day 186	06:30 8 knots NE wind Sea state 3 Pressure 1018 hPa	06:30 Latitude 65° 28.4' N. Heading north along Norwegian coast 17:41 ships time (15:41 GMT) crossed the Arctic Circle 66 °33.5' N, 7° 11'E Master emailed Governor of Svalbard to check on permissions for working within the protected zone (Station B8)
06/07/2017 Day 187	15:00 9 knots W wind Sea state 3 Pressure 1012 hPa	Confirming pick up times and locations for those being transferred in Tromso
07/07/2017 Day 188	08:30 14 knots SW wind Sea state 3-4 Pressure 1012 hPa	Weekly DipClear Report submitted Position 69° 36.5'N, 017° 52.0'E (pilot boarding position off Hekkingen Island) at 09:00 (local time). Boat transfer of remaining 12 pax. 11:00 Science/tech briefing in bar 17:05 Shake-down CTD at B1 (E1) 18:02 Day Grab (E2) 18:46 Mega corer x 3 (E3-5)
08/07/2017 Day 189	06:00 9 knots SW wind Sea state 3 17:30 4 knots E wind Sea state 2 9°C air temp, bright sunshine	09:10 CTD at B2 (E6) 10:04 Zoonets (E7-9) 11:40 SAPS (E10) 13:57 Grab (E11-E12) 14:51 Megacorer (E13-15) 20:57 Zoonets (E16-17) Water retention OK BASMU happy for Richie to stay onboard – no MediVac required
09/07/2017 Day 190	07:00 5 knots SW Sea state 2 8°C air temp	08:57 CTD at B4 (E18) 09:56 Zoonets (E19-20) 11:01 SAPS (E21) 11:38 Drone flights (E22-23) 13:17 SUCS (E24-25) 14:55 Megacorer (E26-28)

		17:11 Done flight (E29) Crashed into starboard gantry! H&S report 21:00 Zoonets (E30-31)
10/07/2017 Day 191		09:00 CTD at B6 (E32) 09:38 Zoonets (E33-35) 10:49 SAPS (E36) 12:54 SUCS (E37) 14:18 Megacorer (E38-E40) 20:59 Zoonets (E41-42)
11/07/2017 Day 192	14:00 19 knots E wind Sea state 4 Pressure 1007.5 hPa	B7 03:05 Day grab (E43) 03:45 Megacorer (E44-46) B8 09:06 CTD (E47) 09:46 Zoonets (E48-49) 10:36 SAPS (E50) 12:19 SUCS (E51) Too many rocks on seabed for megacorer – transit back to B7 B7 15:29 CTD (E52) (physics/nutrients) B21 18:30 CTD (E53) (phys/nutrients) B9 22:18 Megacorer (E54-56)
12/07/2017 Day 193	06:00 18 knots SE wind Sea state 4 Pressure 1005 hPa Air temp 6°C	B10 07:06 CTD (surface – 200 m) (E57) 08:31 CTD Full depth (E58) 10:33 Zoonets (E59-60) 11:50 SAPS (E61) 14:09 Megacorer (E62-64) 21:00 Zoonets (E65-66)
13/07/2017 Day 194	12:00 8 knots SW wind Sea state 3 Pressure 1005 hPa Air temp 7°C	B19 01:02 CTD (E67) (physics/nutrients) B9 07:01 CTD Full depth (E68) 09:19 CTD (surface – 200 m) (E69) 09:53 Zoonets (E70-72) 11:01 SAPS (E73) B20 14:31 CTD (physics/nutrients) (E74) 15:23 SUCS (E75) B9 20:59 Zoonets (E76-E77)
14/07/2017 Day 195	06:30 23 knots W wind Sea state 5 Pressure 1007.5 hPa Air temp 5°C	Weekly DipClear Report submitted B11 09:02 CTD (E78) 09:45 Zoonets (E79-80) 11:00 SAPS (E81) 13:03 SUCS (E82-83) Problem with sheave on E82 14:37 Megacorer (E84-86) B22 18:13 CTD (E87)

		<p>B11 21:01 Zoonet (E88-89)</p>
15/07/2017 Day 196		<p>B12 07:03 CTD (E90) 07:41 Zoonets (E91-92) 08:38 SAPS (E93) Problem with the winch. ETO called. Deployment cancelled while fault investigated.</p> <p>10:45 SUCS (E94). Too rocky for megacoring. 12:05 SAPS (E95) Off the coring wire</p> <p>B13 22:29 Zoonets (E96-E97) 23:32 Day Grab at B13 Site 1 (E98) Failed. Safety pin left in.</p>
16/07/2017 Day 197	<p>08:30 12 knots SW wind Sea state 3-4 Air temp 7°C Misty</p>	<p>B13 00:06 Day grab at B13 Site 1 (E99). Did not fire. Unknown reason. Perhaps too light and slow. 00:58 SUCS (E100) Started Site 1, moved through Site 3, finished at Site 5. Diagonal across the box.</p> <p>03:14 Megacorer around Site 3 (E101-104)</p> <p>Vessel moved 2 nm south of working site to avoid any sediment contamination. 74 28.0362°N, 30 0.0480°E</p> <p>09:00 CTD (E105) 09:50 Zoonets (E106-107) 11:05 SAPS (E108)</p> <p>Move back to benthic box 13:24 SUCS (E109) DP error forces early recovery of SAPS 14:45 DP error resolved 15:11 SUCS (E110) 16:33 SMBA Box corer (E111-115) (5 deployments) 20:02 USNL Box corer (E116-129) (15 deployments) 3 hrs needed to sieve material from USNL corer</p>
17/07/2017 Day 198	<p>04:30 20 knots SE wind Sea state 4 Air temp 8°C</p>	<p>03:00 Finished USNL box coring 06:07 Agassiz trawls (E130 -137). Weights added. Beam trawl not used since it is too light. 14:54 Glider deployed (E138) 16:06 CTD (E139) Transit to B15</p> <p>19:00 (approx.) Turned south to recover glider that had not been calling in 19:30 (approx.). Turned back north again – Glider now OK!</p>
18/07/2017 Day 199	<p>19:30 7 knots E wind Air temp 0°C Pressure 1011 hPa</p>	<p>In transit to B15 Modified B15 location to be slightly further south and in deeper water [78° 15'N, 30° 00.00'E, 330 m]</p> <p>15:05 Ice Edge! 19:00 Polar Bears – Mother and two cubs</p> <p>B15</p>

		20:56 Zoonets at B15 (E140-141) 22:37 SUCS at Site 1 (E142)
19/07/2017 Day 200	09:30 6 knots S wind Air temp 1°C Pressure 1006 hPa	New 200 m x 200 m box defined to the NE to avoid ice. Site 10 (NW) : 78 15.157'N, 30 00.27'E Site 11 (NE) : 78 15.157'N, 30 00.80'E Site 12 (SE): 78 15.05'N, 30 00.80'E (above positions taken from sheet on notice board) Site 13 (new centre) : 78 15.1014'N, 30 0.5406'E Site 1 (SW) 00:37 SUCS (E143) around 1-10-11-12 02:57 Megacorer (E144-146) around site 13 (new centre) Repositioned 2 nm south for pelagic work 78 12.8598'N, 30 0.0264'E 11:00 Swivel changed on CTD 09:30 CTD (E147) 10:14 Zoonets (E148-149) 11:30 SAPS (E150). Deployed starboard mid-ships to avoid ice off bow. Relocate to site 13 14:24 SMBA cores (E151-155) 18:12 USNL cores (E156-170)
20/07/2017 Day 201		03:22 Agassiz trawls (E171-177) 10:48 Transit to B17 13:15 Underway system turned off – pumps being blocked with ice
21/07/2017 Day 202	10:00 8 knots N wind Air temp 0°C Pressure 1010 hPa	Weekly DipClear Report submitted 06:00 Transit overnight slow – sometimes only 3 nm in an hour. Thick fog making visibility hard. Following a lead NW but ice thick and progress slow. Cold container suffered increase in temperature once water supply turned off. Change of plans. Will work at B16 whilst it is relatively accessible and re-assess B17 in a few days. 14:37 Arrive at B16 Ice and current conditions make working SUCS difficult 15:33 SUCS (E178) (near site 5) 17:09 SUCS (E179) (near site 2) 20:14 SUCS (E180) - better deployment – ship drifting with ice rather than trying to stay on DP Continue drifting with ice/currents 20:58 Zoonets (E181-182) 22:21 Megacorer (E183-185) Ship drifted with ice until the morning
22/07/2017	12:30	08:02 CTD (E186). Pelagic site approx. 2nm North of benthic

Day 203	21 knots S wind Air temp 0°C Pressure 1016 hPa	area 08:41 Zoonets (E187-188) 09:33 SAPS (E189) 13:06 SMBA coring (E190-194) 17:28 USNL coring (E195-210)
23/07/2017 Day 204	14:00 35 knots NW wind Air temp 2.5°C Pressure 1015 hPa Sea state 6	02:00 USNL coring finished 04:14 Agassiz trawls (E211-218) 11:00 Seapath shut down – unknown failure. IT/Comms trying to fix it. VMADCP turned off. 12:13 Start transit to B17 (shelf-edge station) 19:00 Laura/Dan moved incubations and cores into the cold spec. room in an attempt to keep them cool and at a stable temperature. Temperature dropped to 1°C. Samples being stored at the previously 4°C were moved into the cargo fridge in the hold.
24/07/2017 Day 205	07:30 4 knots W wind Air temp -2°C Pressure 1013 hPa Sea state 1	Timer on the cargo fridge was faulty resulting in an increase in temperature overnight to 7°C. This was subsequently fixed and the temperature remained stable. B17 09:37 Arrive B17 (more central location within the trough) 11:08 SUCS (E219-222) 13:48 Megacorer (E223-226) 16:25 USNL corer for Lauras incubation samples (E227-230) Reposition further north 21:00 Zoonets (E231-232)
25/07/2017 Day 206		01:46 CTD at B24 in 870 m (E233). Physics and nutrients. 04:10 CTD at B23 in 380 m (E234). Physics and nutrients. Transit back to B17 working area Concerns over the #2 -80°C freezer warming up (to -60°C). This is likely the result of it being opened/closed often. 08:00 CTD at B17 (E235) 08:40 Zooplankton nets (E236-237) 09:34 SAPS (E238) 11:43 Agassiz trawls (E239-244). Trawling further north of SUCS and coring site to take advantage of the light winds and open leads 18:28 Start relocation to B17 coring area further south 00:00 Approx. Abandoned search for open water. Ice too tightly packed to work coring. Transit north towards shelf edge and deep, off-shelf CTDs.
26/07/2017 Day 207		04:09 CTD at B25 (1500 m) (E245) 06:39 CTD at B26 (2000 m) (E246) B18 11:03 CTD at B18 (surface-200m) (E247) 12:00 CTD at B18 (Full depth) (E248) 14:16 Zooplankton net (E249)

		<p>15:03 SAPS (E250) 16:57 Megacorer (E251-252) 22:09 Zooplankton net (E253)</p> <p>Return to Station 17</p>
27/07/2017 Day 208		<p>B17 07:41 SMBA corer (E254). Too much gravel. Reposition. 09:52 SMBA corer (E255-260). 12:03 USNL corer (E261-262). Too much gravel. Reposition. 14:14 USNL corer (E263-275) 20:30 SUCS (E276) Transit south</p>
28/07/2017 Day 209		<p>Weekly DipClear Report submitted</p> <p>01:46 CTD at B27 (E277) 05:32 CTD at B28 (E278) 11:19 CTD at B16 (E279) 15:52 CTD at B29 (E280) 19:28 CTD at B30 (E281) 23:14 CTD at B31 (E282)</p>
29/07/2017 Day 210	<p>10:00 15 knots N wind Air temp 0°C Sea state 4 Pressure 1012 hPa</p>	<p>03:49 CTD at B32 (E283) 07:47 CTD at B33 (E284)</p> <p>Cold container being reconverted to air con – UW cooling Some ice on approach to B15</p> <p>13:19 CTD at B15 (E285) 14:07 USNL corer (E286-289) 20:39 CTD at B34 (E290) Transit to B14</p>
30/07/2017 Day 211	<p>08:00 12 knots N wind Sea state 3-4 Air temp 1°C Pressure 1013 hPa</p>	<p>B14 01:45 SUCS at B14 (E291-292). Sites 1, 2, 4, 5 05:23 Megacorer (E292-295). Sites 5, 2, 1</p> <p>Reposition 3 nm west for pelagic work</p> <p>09:00 CTD (E296) 09:40 Zoonet (E297-298) 10:43 SAPS (E299) 13:13 Agassiz trawls (E300-307)</p> <p>Reposition 1nm W for net 21:44 Zoonet (E308-309) Return to benthic box (site 3) 23:12 SMBA (E310-314)</p>
31/07/2017 Day 212	<p>18:30 14 knots W wind Air temp 4 °C Sea state 3-4 Pressure 1011 hPa</p>	<p>01:41 USNL (E315-326)</p> <p>Approach last known glider position (West of B14) 11:04 CTD (E327) Glider calibration cast 14:28 Glider recovered to deck (E328)</p> <p>19:38 CTD at B35 (E329)</p>
01/08/2017 Day 213		<p>01:27 CTD at B13 (E330) 02:29 USNL cores (E331-334)</p>

		<p>06:10 SMBA cores (E335-344) 10:08 Agassiz trawls (E345-348)</p> <p>Start cross-bank transect 18:50 CTD at B36 (E349) 23:07 CTD at B12 (E350)</p>
02/08/2017 Day 214		<p>03:25 CTD at B37 (E351) 07:42 CTD at B11 (E352) 11:05 CTD at B38 (E353) 16:55 CTD at B8 (E354)</p> <p>B7 20:56 Zooplankton nets at B7 (E355-356)</p>
03/08/2017 Day 215	<p>17:00 7 knots E wind Sea state 3 Air temp 3°C Pressure 1011 hPa</p>	<p>08:59 CTD at B7 (E357) 09:34 Zooplankton nets (E358-359) 10:27 SAPS (E360) 12:36 SUCS (E361)</p> <p>14:00-16:30 two Swedish rowers came onboard</p> <p>18:37 CTD at B39 (E362) 23:06 CTD at B6 (E363)</p>
04/08/2017 Day 216	<p>13:00 3 knots NW wind Sea state 3 Air temp 4°C Pressure 1010 hPa</p>	<p>Weekly DipClear Report submitted</p> <p>03:20 CTD at B40 (E364) B5 08:45 CTD at B5 (E365) 09:27 Zooplankton nets (E366-367) 10:12 SAPS (E368) 12:21 SUCS (E369) 16:29 CTD at B41 (E370) 20:57 Zooplankton nets at B5 (E371-372)</p>
05/08/2017 Day 217	<p>07:00 23 knots E wind Sea state 4 Air temp 8°C Pressure 1009 hPa</p>	<p>03:29 CTD at B4 (E373)</p> <p>B3 08:57 CTD at B3 (E374) 09:39 Zooplankton net (E375-376) 10:26 SAPS (E377) 12:38 SUCS (E378) 15:26 Megacorer (E379-382) Moved 1 nm north of benthic working area 20:56 Zooplankton nets (E383)</p>
06/08/2017 Day 218	<p>10:00 22 knots E wind Sea state 5 Air temp 8°C Pressure 1012 hPa</p>	<p>02:00 SMBA corer (E385-389) 04:29 USNL corer (E390-400) 09:52 Agassiz trawls (E401-407)</p> <p>21:33 CTD at B42 (E408). Unable to work on location due to seismic survey being carried out by vessels in close proximity to original site. Vessel repositioning 5' South to revised B42 site.</p>
07/08/2017 Day 219	<p>07:00 12 knots S wind Sea state 3 Air temp 12°C</p>	<p>00:29 CTD at B2 (E409) 04:03 CTD at B43 (E410)</p> <p>B1</p>

	Pressure 1008 hPa	08:03 CTD (E411) 08:32 Zooplankton Nets (E412-413) 09:24 SAPS (E414) 11:40 SUCS (E415) 12:06 End of Science 16:00 End of cruise dinner and drinks
08/08/2017 Day 220		08:00 Alongside at berth 22 in Tromso
09/08/2017 Day 221		07:00 Leave Tromso for passage home
10/08/2017 to 14/08/2017 Day 222-226		Passage to Southampton
15/08/2017 Day 227		06:00 Local time. Board Pilot 08:00 Dock at berth 49 in Southampton Begin de-mobilization
16/08/2017 Day 228		12:00 De-Mobilization ends

1.4 Station locations

Table 1.4.1. Nominal station locations and depths (from IBACO bathymetry). Please refer to the cruise event log for the exact locations and depths of each activity at these stations.

Station	Latitude	Longitude	Nominal depth (m)	
B1	70° 46' N	20° E	188	Full pelagic sampling
B2	71° 42' N	19° 40' E	256	Full pelagic sampling
B3	72° 38' N	19° 15' E	368	Full benthic and pelagic sampling
B4	73° 22' N	18° 55' E	476	Full pelagic sampling
B5	74° 22' N	18° 10' E	122	Full pelagic sampling
B6	75° 11' N	17° 32' E	145	Full pelagic sampling
B7	76° N	16° 50' E	325	Full pelagic sampling
B8	76° 22' N	16° 40' E	45	Full pelagic sampling
B9	76° N	13° 40' E	1005	Full pelagic sampling
B10	76° N	10° 40' E	2230	Full pelagic sampling
B11	76° 22' N	21° E	231	Full pelagic sampling
B12	75° 30' N	26° E	139	Full pelagic sampling
B13	74° 30' N	30° E	363	Full benthic and pelagic sampling
B14	76° 30' N	30° 30' E	294	Full benthic and pelagic sampling
B15	78° 15' N	30° E	269	Full benthic and pelagic sampling
B16	80° 6' N	30° E	287	Full benthic and pelagic sampling
B17	81° 19.4' N	29° 13.6' E	229	Full benthic and pelagic sampling
B18	81° 43.5' N	29° 52.1' E	3060	Full pelagic sampling
B19	76° N	12° 30' E	1650	Additional hydrography
B20	76° N	14° 30' E	325	Additional hydrography
B21	76° N	15° 30' E	370	Additional hydrography
B22	76° 12' N	21° 50' E	108	Additional hydrography
B23	81° 27.5' N	29° 59.1' E	386	Additional hydrography
B24	81° 30.5' N	29° 46.3' E	637	Additional hydrography
B25	81° 33.9' N	29° 46.3' E	1340	Additional hydrography
B26	81° 36.9' N	29° 29.1' E	1976	Additional hydrography
B27	80° 59.5' N	29° 18.6' E	387	Additional hydrography
B28	80° 40.2' N	29° 17.6' E	396	Additional hydrography
B29	79° 40.0' N	28° 40.0' E	271	Additional hydrography
B30	79° 18.0' N	27° 30.0' E	296	Additional hydrography
B31	79° 6.0' N	25° 40.0' E	224	Additional hydrography
B32	78° 50.0' N	23° 50.0' E	169	Additional hydrography
B33	78° 22.0' N	26° 10.0' E	247	Additional hydrography
B34	77° 20.0' N	30° 00.0' E	192	Additional hydrography
B35	75° 30.0' N	30° 00.0' E	370	Additional hydrography
B36	75° 6.0' N	28° 4.2' E	334	Additional hydrography
B37	75° 57.0' N	23° 34.8' E	60	Additional hydrography
B38	76° 11.4' N	18° 53.4' E	237	Additional hydrography
B39	75° 36.0' N	17° 12.0' E	176	Additional hydrography
B40	74° 47.0' N	17° 52.0' E	256	Additional hydrography
B41	73° 52.0' N	18° 33.0' E	204	Additional hydrography
B42	72° 4.9' N	19° 30.1' E	324	Additional hydrography
B43	71° 14.0' N	19° 50.2' E	204	Additional hydrography

**JR16006
July-August 2017**

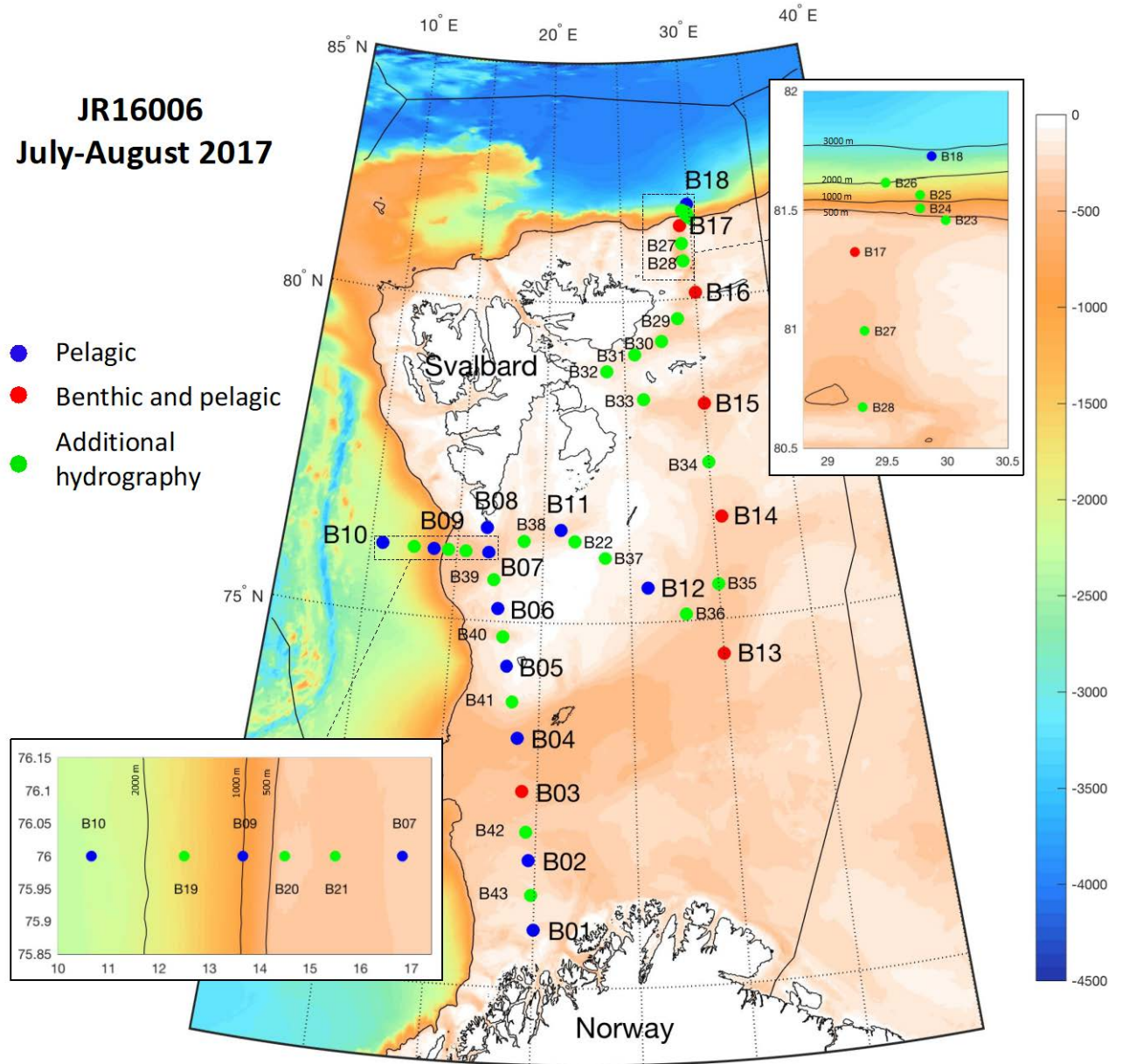

Figure 1.1 Map of JR16006 station locations

2. Hydrography, physics and computing

2.1 Computing

Peter Lens (BAS)

On board IT Support

End of Cruise Backups

A snapshot of all files stored under K: (which includes *legwork* and *legdata*) was made on 15th August 2017. Archive copy stored on the Cambridge Storage Area Network (SAN) under

```
/data/cruise/jcr/20170629
```

Truwind

File truwind.ACO file created at the end of the cruise, stored in scs\Compress folder.

GPS Navigation data

At 14:59 on 16 July 2017 (UTC) the JCR Bridge reported loss of heading while on DP (dynamic position). The Kongsberg Seapath320+ was reporting inaccurate GPS. Science operations stopped while the Seapath system was restarted.

reboot at 14:40

restored at 14:43

no time in zda stream until 14:57 when time and GPS correct

Further investigation found the problem to be seagulls seated on the GPS antennas. Recommend anti bird equipment fitted during refit.

On 23rd July at 03:16:21 the Seapath320+ data became unstable and failed completely at 10:53:08 80.03531436N, 030.02922286E. Kongsberg report that the firmware in the GNSS receivers mis-handled a week rollover. This resulted in both the main and spare Seapath units failing at the same time.

Because so many instruments on board the JCR rely on the Seapath data it was thought best to loopback other streams to make it appear as if the Seapath was functioning. The Ashtech, Furuno and gyro streams were used as follows:

Original

Seatex-gga.ACO (\$INGGA)

Seatex-gll.ACO (\$INGLL)

Seatex-vtg.ACO (\$INVTG)

Seatex-hdt.ACO (\$INHDT)

Is a repeat of this stream

Ashtec.ACO (\$GPPAT)

Furuno-gll.ACO (\$GPGLL)

Furuno-vtg.ACO (\$GPVTG)

Gyro.ACO (\$HEHDT)

So it is important to note that from 20170723 at 16:42:45 the Seatex-XXX.ACO files contain a mix of data from other instruments and not real SeaPath320+ data.

On 5th August 2017 it was noted that the Ashtech RAW and ACO files contain non-numeric characters and after some investigation that the Ashtech data is of poor quality. An example of which can be seen in Figure 2.1.1 comparing latitude and longitude for the Ashtec and Furuno instruments;

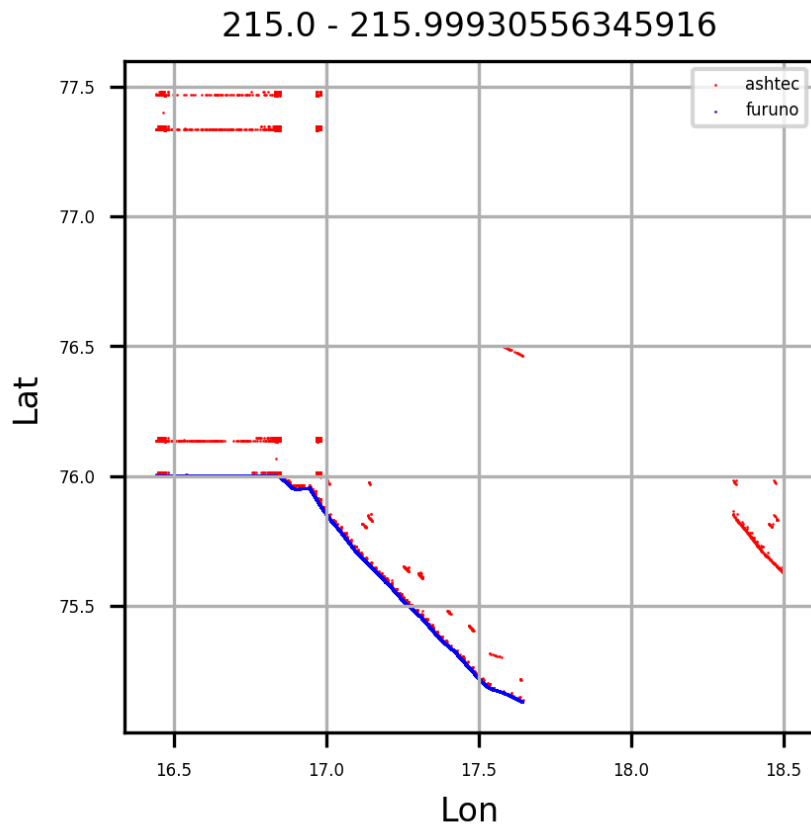

Figure 2.1.1. Latitude and Longitude for the Ashtec and Furuno instruments

For all future data processing requirements it is recommended that scientists either;

1. Use the Furuno GPS stream for the entire period of the cruise.
2. Use Seatex up to 23rd July at 03:16:21 and then the Furuno for the remainder.

On 8th August a Kongsberg engineer repaired the Seapath320 during the Tromso call. Seapath data streams were returned to normal configuration (IE no loopback of data, all streams correctly labelled) at 07:42:18 on 10th August 2017.

VSAT signal and Internet connection

Lost satellite link on 14th July at approx. 20:00 UTC, 76.32N, 21.22E, enroute to B12. Sporadic connections and some data throughput for several hours following.

Satellite signal appeared again on the 30th July but was very poor with little throughput until 2nd August around 07:00 UTC. Internet back with strength around 76.35N, 16.67E heading for B11.

SCS underway data collection

SCS acquisition started at	20170629 09:25:42
SCS acquisition stopped at	20170723 16:39:40 (broken Seapath issue)
SCS acquisition started at	20170723 16:42:45
SCS acquisition stopped at	20170810 07:39:16 (to restore changes made above)
SCS acquisition started at	20170810 07:42:18
SCS acquisition stopped at	20170815 (end of cruise)

2.2 CTD data

¹Estelle Dumont (SAMS) and William Clark (BAS)

¹*Data set PI and author*

Core CAO Programme Data set

CTD sensor serial numbers

Instrument	S/N Used
Deck unit SBE11plus	0458
Underwater unit SBE9plus	0771
Temp 1 sensor SBE3plus	5623
Temp 2 sensor SBE3plus	4874
Cond 1 sensor SBE 4C	4087
Cond 2 sensor SBE 4C	3248
Pump 1 SBE5T	2400
Pump 2 SBE5T	1807
Standards Thermometer SBE35	0051
Transmissometer C-Star	1505
Oxygen 1 sensor SBE43	0242
Oxygen 2 sensor SBE43	0620
PAR sensor	70636
Fluorometer Aquatracka	12-8513-003
Altimeter PA200	26993
LADCP	Master: 14443 (Down) Slave: 14897 (Up)
CTD swivel linkage	196115
Pylon SBE32	01106

(Temp 1, Cond 1, Oxygen 1 and Pump 1 are on the first water duct; Temp 2, Cond 2, Oxygen 2 and Pump 2 are on the second water duct.)

Data processing

The first part of the CTD data processing was carried out using Seabird Data Processing version 7.26.4.23. The following modules were run:

1. Data Conversion:

Inputs: JR16006_NNN.hex, JR16006_NNN.XMLCON, JR16006_NNN.bl,
JR16006_NNN.hdr

Outputs: JR16006_NNN.cnv, JR16006_NNN.ros

Conversion of raw data from engineering units to binary .cnv files and creation of the .ros files. The variables exported were:

scan: Scan Count
latitude: Latitude [deg]
longitude: Longitude [deg]
timeJ: Julian Days
timeS: Time, Elapsed [seconds]
pumps: Pump Status
prDM: Pressure, Digiquartz [db]
t090C: Temperature [ITS-90, deg C]
t190C: Temperature, 2 [ITS-90, deg C]
c0mS/cm: Conductivity [mS/cm]

c1mS/cm: Conductivity, 2 [mS/cm]
sbeox0V: Oxygen raw, SBE 43 [V]
sbeox1V: Oxygen raw, SBE 43, 2 [V] (*from cast 014 onwards*)
sbeox0Mm/L: Oxygen, SBE 43 [umol/l]
sbeox1Mm/L: Oxygen, SBE 43, 2 [umol/l] (*from cast 014 onwards*)
v1: Voltage 1
flC: Fluorescence, Chelsea Aqua 3 Chl Con [ug/l]
v0: Voltage 0
CStarAt0: Beam Attenuation, WET Labs C-Star [1/m]
CStarTr0: Beam Transmission, WET Labs C-Star [%]
v2: Voltage 2
par: PAR/Irradiance, Biospherical/Licor
v3: Voltage 3
altM: Altimeter [m]

The default oxygen Tau and hysteresis corrections were applied.

The .ros files were created from the .bl file, using a 5s scan range duration and a scan range offset of -2.5s.

The depth exported at this stage was only for indicative purposes in the bottle files. A more accurate depth calculation was performed at the Derive stage.

2. WildEdit:

Input & output: JR16006_NNN.cnv

Flagging of major spikes. Wild Edit's algorithm requires two passes through the data: the first pass removed data points over 2 standard deviations of a 100 scans average, while the second pass removed the data over 20 standard deviations of a 100 scans average.

3. Filter:

Input & output: JR16006_NNN.cnv

Smoothing of the high frequency pressure and depth data using a low-pass filter (value of 0.15, as recommended by Seabird).

4. AlignCTD:

Input & output: JR16006_NNN.cnv

Shifting some variables relative to pressure to compensate for sensor time-lag.

Temperatures: both seem in good agreement, no alignment was performed on either sensor.

Conductivities: the deck unit (SBE11 v1) automatically advanced the primary conductivity by 1.75 scan or 0.073s (Seabird default value). No alignment was carried out on the secondary sensor. Some negative spikes in the secondary salinity data were observed in strong thermocline areas, which are often indicative of the conductivity lagging temperature. The primary sensors data showed the opposite (positive salinity spikes), indicating that the conductivity was advanced too much by the deck unit. Various alignment values were tested (see Figure 2.2.1) before settling on the following values:

-0.031s or -0.75 scans for the primary conductivity (NB: taking into account the automatic advance of +1.75 scans by the deck unit the overall advance was therefore +1 scan).

+0.063s or +1.5 scans for the secondary conductivity.

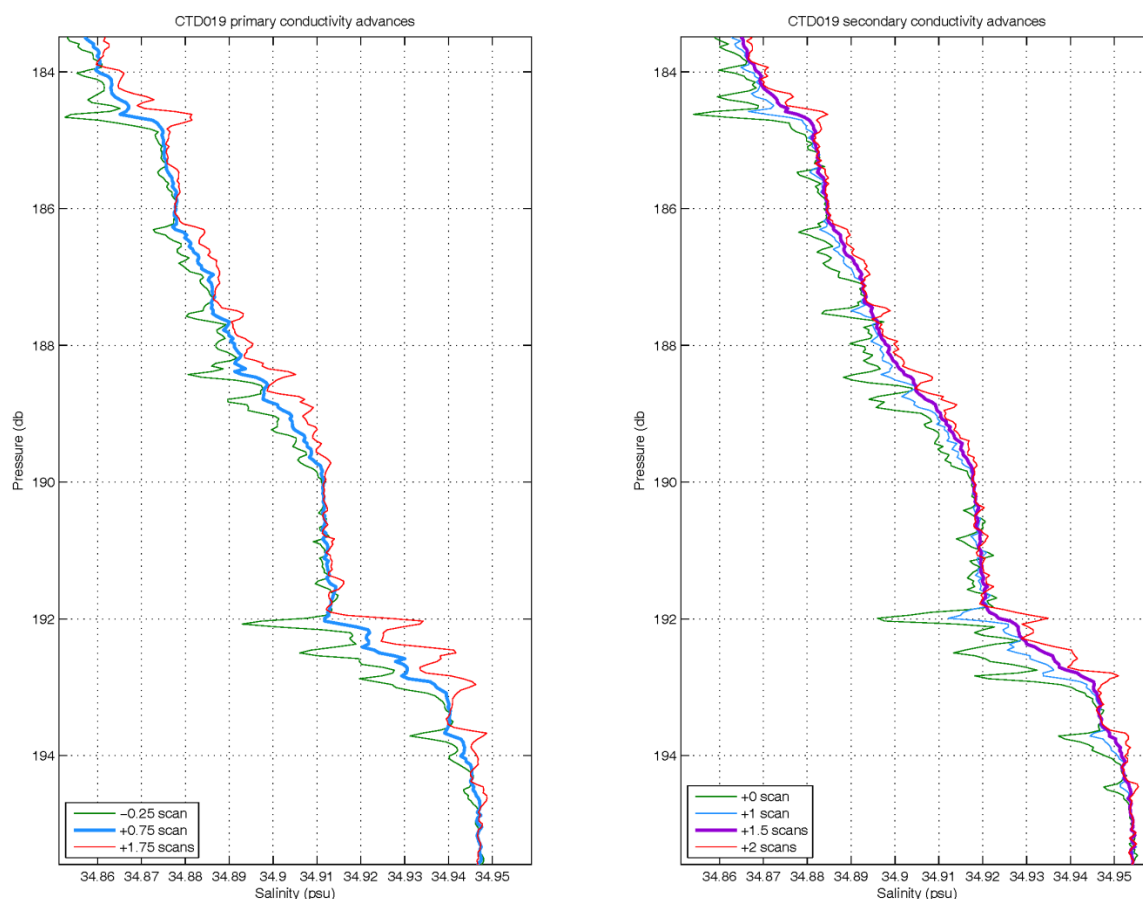

Figure 2.2.1: Conductivity sensors alignment test. Left: the primary sensor was originally advanced by +1.75 scans by the deck unit (red line) which resulted in positive salinity spikes. A value of +0.75 produced a much smoother salinity, but now showing small negative spikes hence the final decision to use an advance of + 1 scan. Right: the secondary sensors, not advanced in the raw data (green line) produced negative salinity spikes. An advance of +1.5 scans appeared to give the best results.

Oxygen: SBE43 sensors have a typical response time of several seconds, varying with each individual sensors and varying with temperature (longer lag at colder temperatures). Several alignment delays were tested on a range of casts, using a wide range of temperature and depths. Due to the water column fluctuations (due to tidal effects, or to the ship’s drift) it was difficult to rely on the oxygen downcast and the upcast profiles being a perfect match in depth. Oxygen readings were plotted against temperature instead, effectively acting as a water mass “tracer” within which oxygen values were expected to stay relatively stable, in order to determine the best alignment (see Figure 2.2.2 and 2.2.3). Selected values were +6s for the primary sensor, and +4s for the secondary, which are in line with the typical SBE43 sensor advance recommended by Seabird (between 0 and 7 seconds). Advances were applied to the oxygen concentration variables as well as the raw voltages for those sensors.

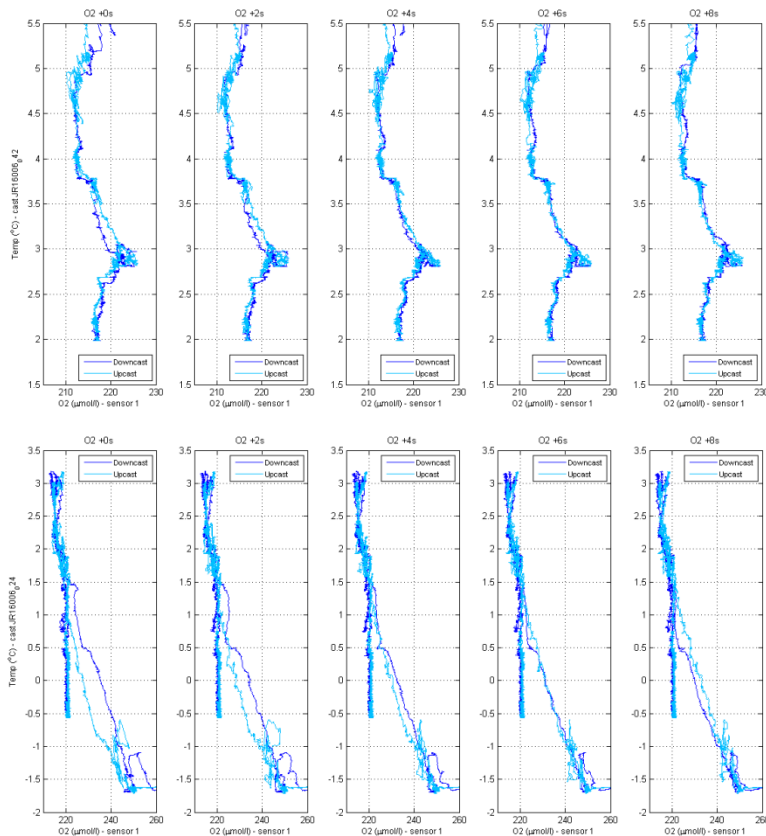

Figure 2.2.2: alignment tests on primary oxygen sensor, on “cold” (cast 24, top) and “warm” conditions (cast 42, bottom). An advance of +6 seconds seems to produce the best results

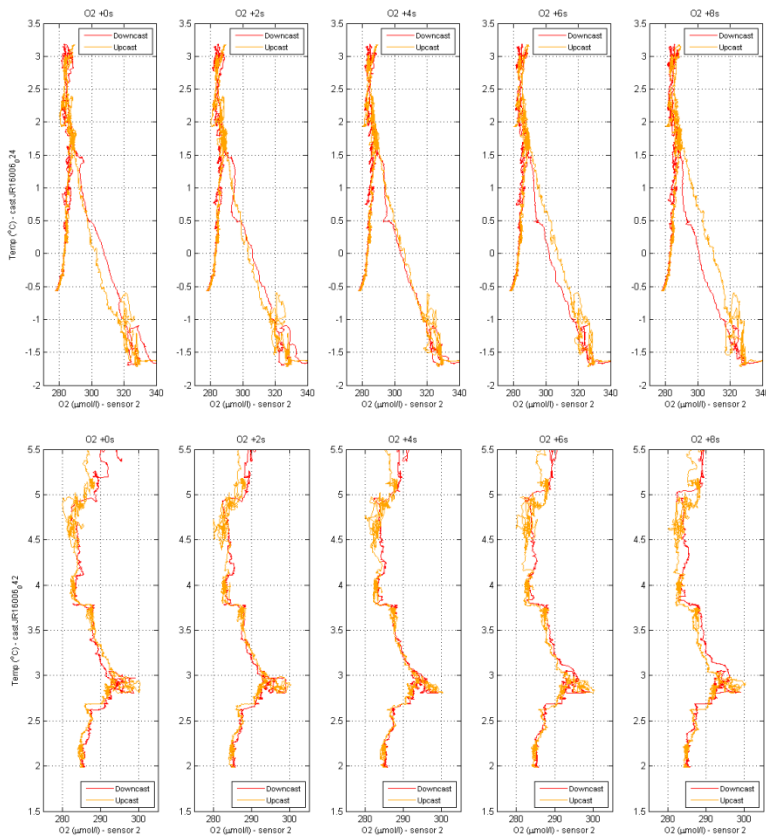

Figure 2.2.3: alignment tests on secondary oxygen sensor, on “cold” (cast 24, top) and “warm” conditions (cast 42, bottom). An advance of 46 seconds seems to produce the best results.

5. CellTM:

Input & output: JR16006_NNN.cnv

A recursive filter run to remove conductivity cell thermal mass effects from the measured conductivity. The constants used were the ones recommended by Seabird: thermal anomaly amplitude $\alpha=0.03$ and thermal anomaly time constant $1/\beta=7$.

6. Derive:

Input & output: JR16006_NNN.cnv

Computation variables derived from the processed pressure, temperature and conductivity:

depSM: Depth [salt water, m]
sal00: Salinity, Practical [PSU]
sal11: Salinity, Practical, 2 [PSU]
sigma- ϵ 00: Density [σ -theta, kg/m³]
sigma- ϵ 11: Density, 2 [σ -theta, kg/m³]
svCM: Sound Velocity [Chen-Millero, m/s]
svCM1: Sound Velocity, 2 [Chen-Millero, m/s]

Note: the Seabird Data Processing software allows for a new computation of the oxygen concentrations at the Derive stage. These were initially computed but the values appeared less satisfactory than the ones computed at the Data Conversion stage (more noisy, and more discrepancy between the downcast and upcast).

7. Translate:

Input & output: JR16006_NNN.cnv

Conversion of binary data to Ascii. The data had been kept in binary format up to this stage to avoid any loss in precision that could occur when converting to Ascii.

8. BottleSum:

Inputs: JR16006_NNN.cnv, JR16006_NNN.bl

Output: JR16006_NNN.btl

Creation of bottle file (.btl), using a 5 seconds window centered around the bottle firing time (as set at the Data Conversion stage). These files were produced for a quick overview of the data at bottle firing times, but the final bottle files are produced later during the Matlab processing.

9. Strip:

Input & output: JR16006_NNN.cnv

Removal of the first depth variable obtained at the Data Conversion stage.

10. Binavg:

Input: JR16006_NNN.cnv

Output: JR16006_NNN_2hz.cnv

Averaging of all variables in 2Hz bins.

11: Binavg:

Input: JR16006_NNN.cnv

Output: JR16006_NNN_LADCP.cnv

Averaging of all variables in 1second bins for LADCP processing.

12. AsciiOut:

Input: JR16006_NNN_LADCP.cnv

Output: JR16006_NNN_LADCP.asc

Reformatting of 1 second-bins file for LADCP processing.

The processing was then completed in Matlab (v. R2013b), where the following steps were carried out:

13. Reading and plotting of “raw” data (as produced after the Seabird processing)

The list of variables contained in the cnv files was obtained from driver files set up at the start of the cruise.

Inputs: JR16006_NNN.cnv, JR16006_NNN_2hz.cnv, JR16006_CTDcnv_24Hz_driver.csv, JR16006_CTDcnv_24Hz_driver_2Hz.csv

Outputs: JR16006_NNN.mat, JR16006_NNN_2hz.mat

14. Creation of bottle files

The scan number for each bottle firing was extracted from the .bl files, and all variables data were extracted in a 5 seconds window centered on the bottle firings. Averages, standard deviations, minimum and maximum values over the 5s window were computed and saved. The data from the SBE35 independent thermometer, if present, was added to the files.

Inputs: JR16006_NNN.cnv, JR16006_NNN.bl

Outputs: JR16006_NNN_BTL.mat, JR16006_NNN_BTL.csv

15. Manual removal of surface soak and out of water data post-cast

The 2Hz pressure, pump status and oxygen data (slowest of all sensors) were plotted on screen, in which the user manually selected the start and end of each cast. The start was defined as the shallowest pressure after the initial surface soak, just before the CTD package started its descent. The end of each cast was selected as the last good oxygen data point (usually around 1m deep). The pumps status data was plotted to ensure the pumps were on at the selected start and end times. The start and end time were saved in a master file and used to crop the 24Hz data.

Inputs: JR16006_NNN_2Hz.mat, JR16006_NNN.mat

Outputs: JR16006_castcrop_times.mat, JR16006_NNN_cropped.mat

16. Split of data in downcast and upcast

The maximum pressure was extracted from the pressure data and the cropped 24Hz data split in downcast and upcast files.

Input: JR16006_NNN_cropped.mat

Outputs: JR16006_NNN_cropped_down.mat, JR16006_NNN_cropped_up.mat

17. Manual removal of spikes and data anomalies

The downcast twin temperatures, twin salinities, twin oxygens, fluorometer, PAR and beam attenuation variables were manually despiked in a graphical user interface. When a point was flagged as bad the matching value was set to NaN. Indexes of data flagged in each variable were saved in each output file. The upcast data were not despiked, although the same Matlab script could be used to do so.

If a primary temperature point was flagged as bad, the matching derived parameters salinity and density were also flagged. The matching oxygen reading was also flagged as bad as the measurement was made from the same parcel of water. The same applied to the secondary sensors. If a primary salinity point was flagged as bad, the matching conductivity and density readings were also flagged as bad. The matching oxygen reading was also flagged as bad as the measurement was made from the same parcel of water. The same applied to the secondary sensors.

The despiking process included flagging of spurious single outliers and of data “anomalies” taking the form of temperature and salinity reversals (lasting a few tenths of seconds) in the thermocline

and / or area of steep salinity gradient (see Figure 2.2.4). These are a common occurrence in CTD data, and are attributed to old water being flushed back into the sensor package as the CTD veer rate slows down due to the ship's heave or fluctuations in the winch's speed.

Input: JR16006_NNN_cropped_down.mat

Output: JR16006_NNN_cropped_down_despiked.mat

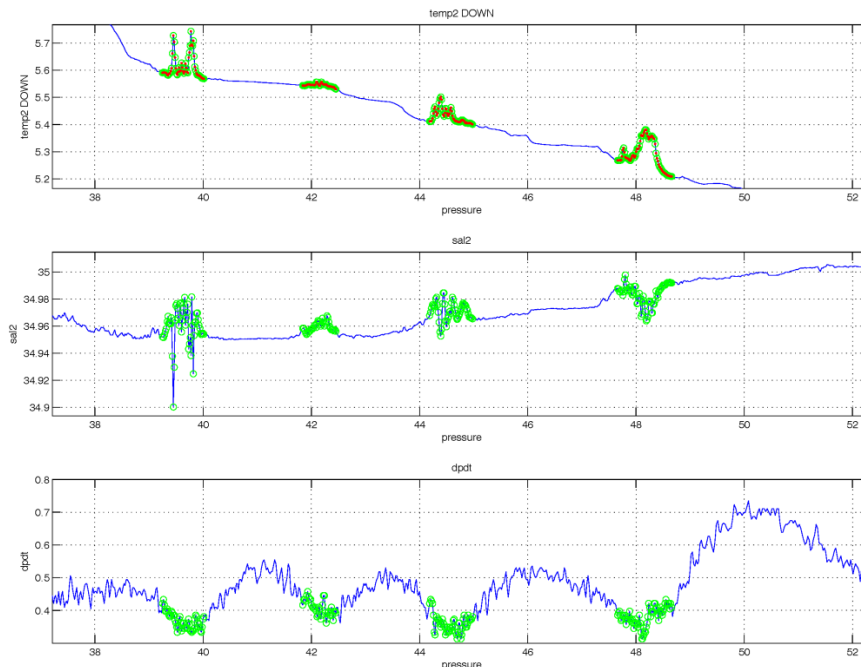

Figure 2.2.4: Example of the CT reversal anomalies (green / red data points) observed in the data. These appear as “bumps” in the data, and match the times of slowest descent rates (bottom plot).

18. Averaging of cast in 1 db-bins

All variables were averaged in 1db-bins, centered around round values. Missing or cropped out data was interpolated for bins between the minimum and maximum pressure. No extrapolation was performed at the surface or at the bottom.

Input: JR16006_NNN_cropped_down_despiked.mat

Output: JR16006_NNN_1db_d.mat

19a. Salinity calibration

201 discrete salinity samples were taken from the CTD Niskins, covering a wide range of salinity values. For each sample the bottle was rinsed 3 times with the Niskin seawater, filled, plastic insert fitted, bottle neck wiped, and lid put on. Once a crate of 24 samples was full, it was placed in the Autosal laboratory to acclimate to temperature for at least one day prior to analysis.

A Guildline 8400B, Sn 68533, was used for all samples. After the first crate had been run the machine was unable to give a stable reading. Biological growth was observed in the cell so it was thoroughly cleaned by removing it and cleaning with a weak bleach solution and cotton buds. This fixed the stability issue and there were no further issues with the Salinometer.

At the start and end of each crate a standard seawater (SSW) sample was analysed, enabling to monitor the drift of the instrument. No clear drift pattern was visible, although the readings varied between -0.003 and + 0.002 psu from the theoretical value. For each crate, the average of the two

SSW offsets was used as the offset to correct the Autosol readings. The conductivity from the CTD sensors was then plotted against the corrected Autosol readings (Fig. 2.2.5).

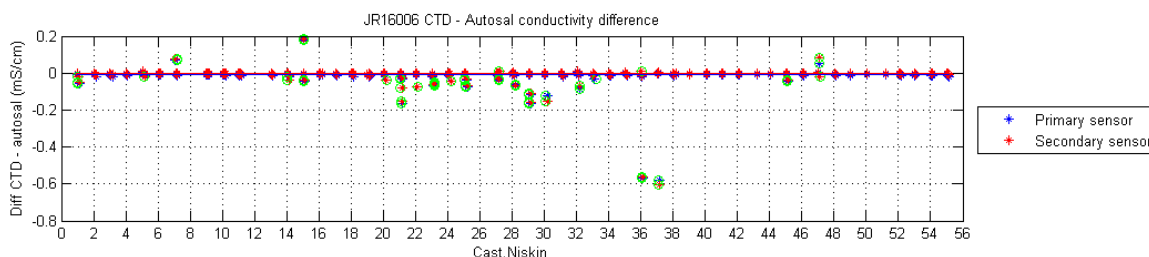

Figure 2.2.5: difference between the raw CTD and Autosol conductivity readings in time, all values.

There did not appear to be any temporal drift in the sensors, or a drift relative to pressure, so a constant offset was used to correct the data of both sensors. The median and standard deviation of the differences between the raw CTD and the Autosol readings were calculated, and all readings with a difference larger than 0.2 standard deviations of the median were excluded from the dataset. The median offset of each subset of selected points was then calculated and used as the correction offset (Fig 2.2.6, 2.2.7 and 2.2.8)

	Sensor 1	Sensor 2
Total numbers of samples	201	201
Number of samples rejected	30 (14.9%)	32 (15.9%)
Conductivity sensor offset ($\text{cond}_{\text{calib}} = \text{cond}_{\text{raw}} - \text{offset}$)	-0.0087 mS/cm	-0.0033 mS/cm

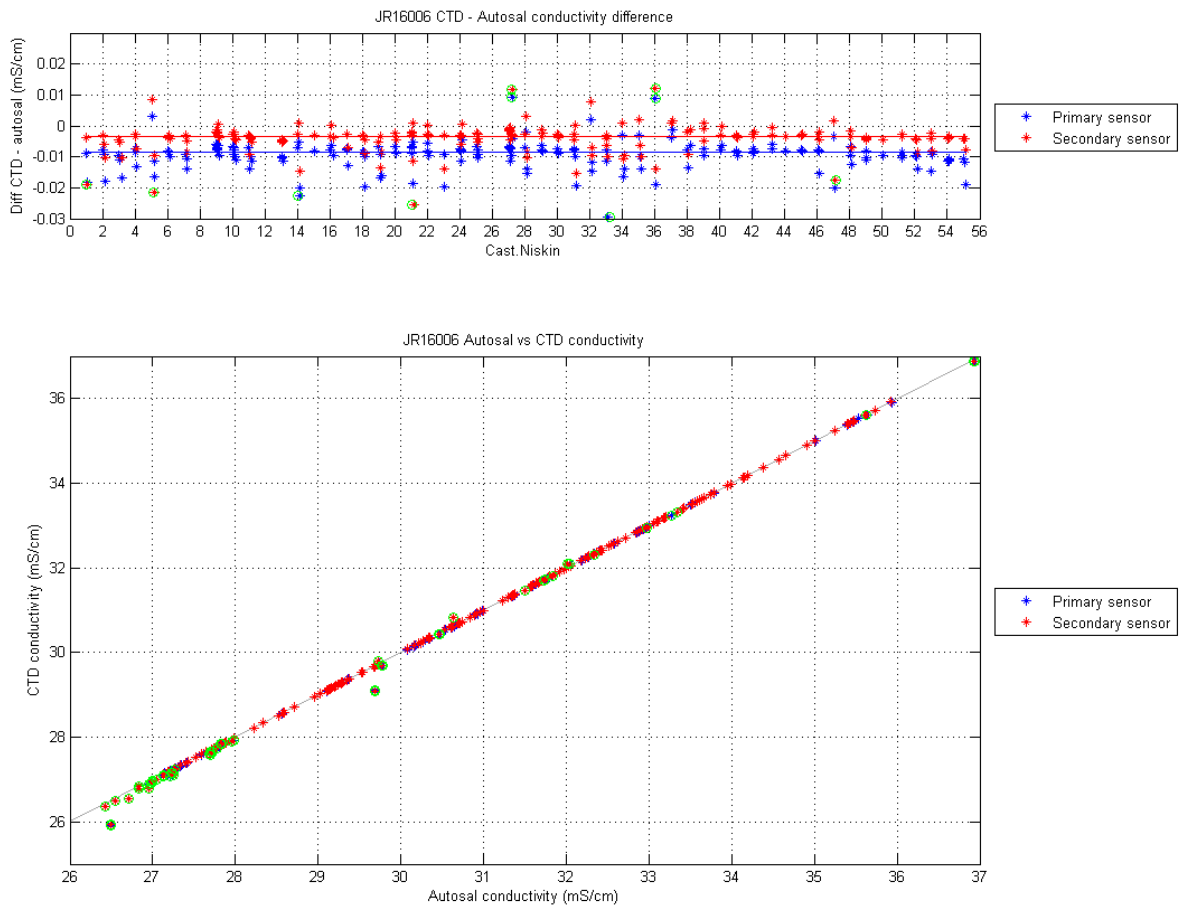

Figure 2.2.6: Top: difference between the raw CTD and Autosol conductivity readings in time, close-up. Bottom: raw CTD vs Autosol conductivity readings. Green circles indicate outliers, removed from dataset before calculating the final sensor offsets. The offsets are the lines shown on the top plot.

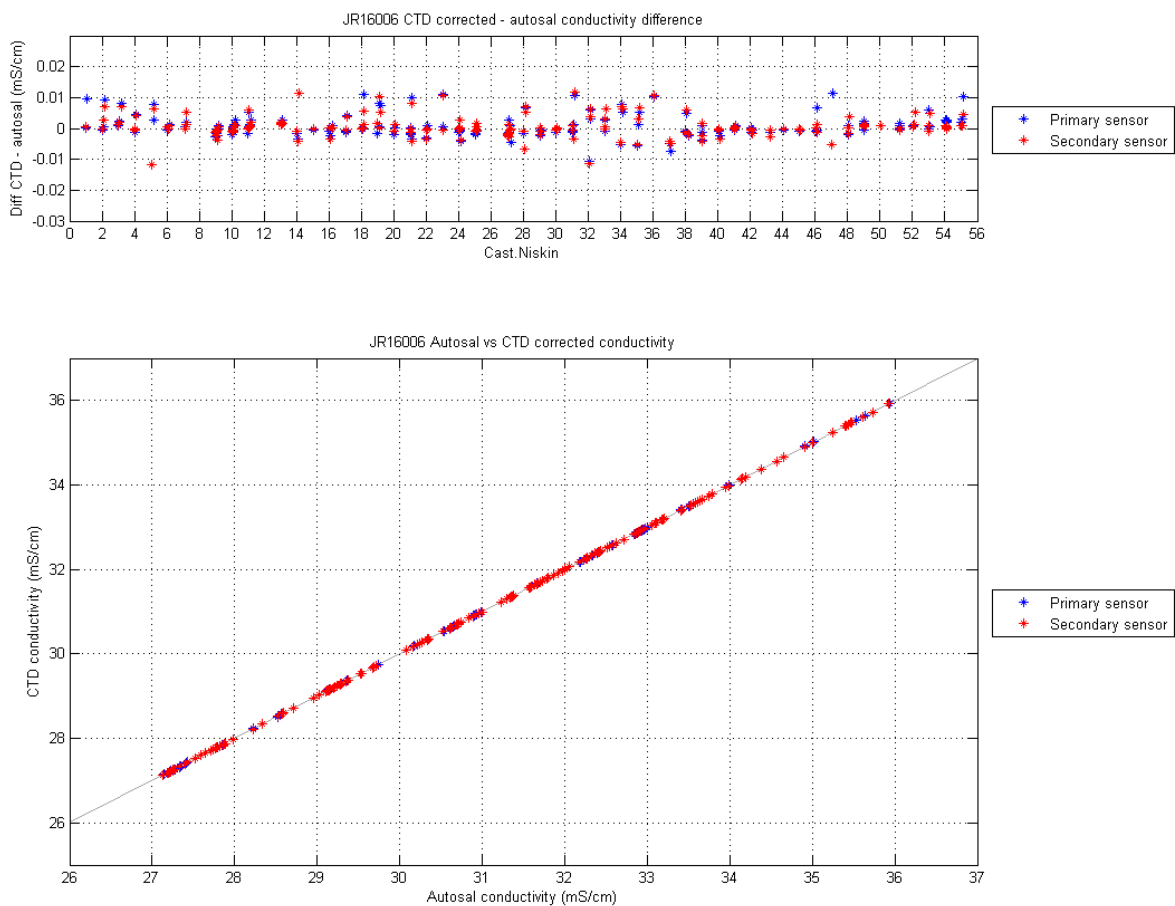

Figure 2.2.7: Top: difference between the corrected CTD and Autosal conductivity readings in time. Bottom: corrected CTD vs Autosal conductivity readings.

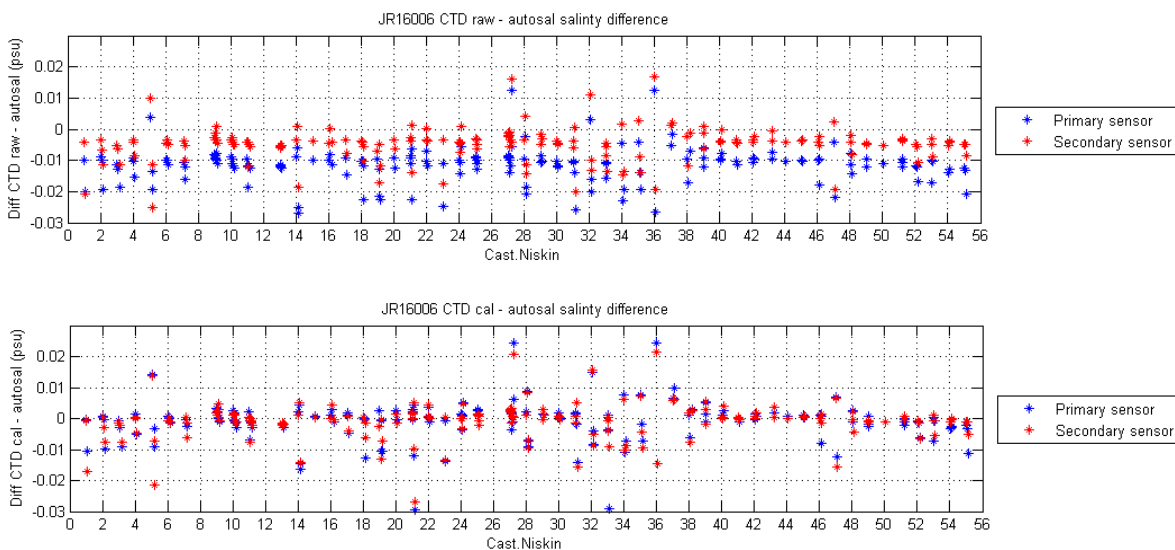

Figure 2.2.8: Top: difference between the raw CTD and Autosal salinity sample readings. Bottom: re-calculated CTD vs Autosal salinity sample readings using the corrected conductivities.

19b. Oxygen calibration

The following calibrations equations were applied to the CTD data:

Sensor 1:

$$\text{Oxy1calib} = \frac{\text{Oxy1raw} - (-5.770)}{0.720}$$

Sensor 2:

$$\text{Oxy2calib} = \frac{\text{Oxy2raw} - (-27.813)}{1.012}$$

See Oxygen section for full details.

Final calibration routine:

Input:

JR16006_NNN_cropped_down_despiked.mat
JR16006_NNN_cropped_up.mat
JR16006_NNN_1db_d.mat

Output:

JR16006_NNN_cropped_down_despiked_calib.mat
JR16006_NNN_cropped_up_calib.mat
JR16006_NNN_1db_d_calib.mat
ascii versions: JR16006_NNN_final_24Hz_down.csv
JR16006_NNN_final_1db_down.csv

Data quality notes / problems

The initial single oxygen sensor (labelled as primary) showed very low values from the start of the cruise. At cast 14 a second sensor was added (labelled as secondary), reading values ~50% higher and a lot closer to the Winkler titration results. After calibration, the data of the first sensor remains dubious, especially at depths >1,000m, and users are advised to work with the second sensor data instead.

The issue of CT reversal anomalies described in stage 17 of the data processing was very visible in open ocean stations (casts 1 to 18, and 37 onwards) but rare for the ice stations (casts 19 to 36), presumably due to the flat calm conditions. However on those stations steeper gradients in the surface layer seem to make the data a lot noisier in places. As the CTD package veer rate was almost constant for those casts it was difficult to attribute the noise to the flushing of old water, or to determine which were the “good” data points (apart from very large single spikes). In those instances no data was flagged as bad. Future users of these datasets might wish to inspect the full 24Hz data and perform their own despiking instead of using the 1db-bin averaged files produced for those casts.

List of CTD casts

Event #	Cast #	Station	Latitude	Longitude	Water depth (m)	Cast depth (m)	Start date & time (UTC)	Bottom time (UTC)	End time (UTC)
1	1	B1	70.76662	20.00052	196	185	07/07/17 17:08	17:13	17:26
6	2	B2	71.69998	19.66600	258	248	08/07/17 09:12	09:20	09:39
18	3	B4	73.36778	18.91804	466	456	09/07/17 09:00	09:10	09:41
32	4	B6	75.18324	17.53340	143	133	10/07/17 09:04	09:08	09:25
47	5	B8	76.36644	16.66520	44	41	11/07/17 09:09	09:12	09:28
52	6	B7	76.00014	16.83258	317	308	11/07/17 15:31	15:41	16:05
53	7	B21	76.00018	15.49822	362	358	11/07/17 18:32	18:41	19:06
57	8	B10	76.00014	10.66700	2260*	204	12/07/17 07:09	07:15	07:37
58	9	B10	76.00014	10.66702	2220	2210	12/07/17 08:35	09:17	10:19
67	10	B19	76.00014	12.49988	1683	1674	13/07/17 01:08	01:38	02:31
68	11	B9	75.99998	13.66686	1011	1002	13/07/17 07:04	07:25	08:11
69	12	B9	75.99998	13.66670	1028*	201	13/07/17 09:21	09:26	09:42
74	13	B20	76.00026	14.49998	321	312	13/07/17 14:34	14:43	15:09
78	14	B11	76.36612	21.00184	227	223	14/07/17 09:04	09:11	09:33
87	15	B22	76.20000	21.83392	105	95	14/07/17 18:15	18:19	18:33
90	16	B12	75.50024	26.00176	136	130	15/07/17 07:05	07:09	07:30
105	17	B13	74.46658	30.00034	353	343	16/07/17 09:02	09:10	09:32
139	18	B13	74.46354	30.00562	354	344	17/07/17 16:08	16:15	16:32
147	19	B15	78.21434	30.00076	324	320	19/07/17 09:32	09:38	10:00
186	20	B16	80.15210	29.91598	288	278	22/07/17 08:04	08:12	08:28
233	21	B24	81.50788	29.77030	878	868	25/07/17 01:50	02:11	02:40
234	22	B23	81.45894	29.98512	397	386	25/07/17 04:13	04:22	04:38
235	23	B17	81.40180	29.50650	288	278	25/07/17 08:02	08:09	08:27
245	24	B25	81.56434	29.77434	1495	1488	26/07/17 04:11	04:39	05:20
246	25	B26	81.61556	29.48518	2005	1996	26/07/17 06:41	07:16	08:04
247	26	B18	81.72590	29.86738	2798*	199	26/07/17 11:06	11:10	11:22
248	27	B18	81.72776	29.86584	2770	2761	26/07/17 12:11	12:58	14:00
277	28	B27	80.99170	29.30430	383	371	28/07/17 01:51	02:00	02:17
278	29	B28	80.67044	29.29416	419	410	28/07/17 05:34	05:45	06:04
279	30	B16	80.10090	30.00288	288	278	28/07/17 11:21	11:27	11:43
280	31	B29	79.66660	28.66584	264	253	28/07/17 15:54	15:59	16:13
281	32	B30	79.33840	27.49934	317	307	28/07/17 19:31	19:38	19:56
282	33	B31	79.11178	25.71700	218	207	28/07/17 23:18	23:24	23:36
283	34	B32	78.83446	23.83980	170	160	29/07/17 03:51	03:56	04:08
284	35	B33	78.36648	26.16960	244	234	29/07/17 07:49	07:54	08:08
285	36	B15	78.25026	30.00738	309	299	29/07/17 13:21	13:27	13:40
290	37	B34	77.33286	29.99910	186	176	29/07/17 20:41	20:46	21:01
296	38	B14	76.49940	30.28700	288	278	30/07/17 09:02	09:08	09:28
327	39	B14	76.44628	29.32724	242	232	31/07/17 11:06	11:11	11:18
329	40	B35	75.49940	30.00074	359	348	31/07/17 19:41	19:49	20:06
330	41	B13	74.49986	29.99840	356	346	01/08/17 01:29	01:37	01:53
349	42	B36	75.09996	28.07046	327	317	01/08/17 18:52	19:00	19:14
350	43	B12	75.49990	25.99922	137	127	01/08/17 23:09	23:13	23:21
351	44	B37	75.94962	23.57838	57	46	02/08/17 03:27	03:29	03:36
352	45	B11	76.36646	21.00044	227	217	02/08/17 07:45	07:50	08:01
353	46	B38	76.18966	18.89302	236	227	02/08/17 11:07	11:12	11:27
354	47	B8	76.36666	16.66620	43	42	02/08/17 16:57	17:00	17:04
357	48	B7	76.00010	16.83342	317	309	03/08/17 09:00	09:07	09:25
362	49	B39	75.59160	17.19256	164	154	03/08/17 18:39	18:44	18:50
363	50	B6	75.18430	17.53442	142	132	03/08/17 23:08	23:12	23:20
364	51	B40	74.77498	17.85888	251	240	04/08/17 03:22	03:28	03:36

365	52	B5	74.36648	18.16632	120	109	04/08/17 08:58	09:02	09:14
370	53	B41	73.86652	18.54946	200	191	04/08/17 16:30	16:35	16:40
373	54	B4	73.36638	18.91722	467	458	05/08/17 03:31	03:42	04:02
374	55	B3	72.63304	19.25012	365	360	05/08/17 08:59	09:07	09:26
408	56	B42	72.0832	19.50124	319	307	06/08/17 21:35	21:42	21:58
409	57	B2	71.69974	19.6644	258	247	07/08/17 00:31	00:38	00:52
410	58	B43	71.23304	19.83626	199	189	07/08/17 04:05	04:11	04:20
411	59	B1	70.76668	19.9979	193	183	07/08/17 08:05	08:09	08:19

* *Depths from ship's echo-sounder.* All other depths are from CTD readings plus altimeter height.

Results

1) Water mass definitions

Depth profiles of individual variables were plotted for each individual cast as well as in TS space for water mass identification (Fig 2.2.9 to 2.2.14). The water mass classification used in the subsequent plots and text is:

Water mass	Description	Pot. temperature limits (°C)	Salinity limits (psu)
Arctic Deep Water (ADW) ¹	Cold and saline bottom waters of the Nansen Basin	~ -1.05	~ 34.91
Arctic Water (ArW) ²	Cold and fresh water of Arctic origin	< 0	< 34.7
Atlantic Water (AtW) ²	Warm and saline waters originating in the Atlantic	> 3	> 34.8
Barents Sea Water (BSW) ²	Cold and saline bottom layer of the Barents Sea, formed by cooling and mixing of AtW, ArW and NCCW	< 2	> 34.8
Coastal Water (CW) / Surface Water (SW) ¹	Warm and fresh surface waters, coming from warming of the MW and / or coastal influences	> 3	< 34.5
Melt Water (MW) ²	Fresh surface layer produced by sea ice melting	0 < T < 3	< 34.4
Norwegian Coastal Current Water (NCCW) ²	Warm and fresh current near the Norwegian coast flowing to the Barents Sea through the Barents Sea Opening	> 3	< 34.4
Norwegian Sea Deep Water (NSDW) ³	Cold and saline bottom waters of the Norwegian sea	-1 < T < 0	34.9 to 35.0

References: ¹ Våge et al, 2016; ² Oziel et al, 2016; ³ Swift and Koltermann, 1988.

2) TS diagrams

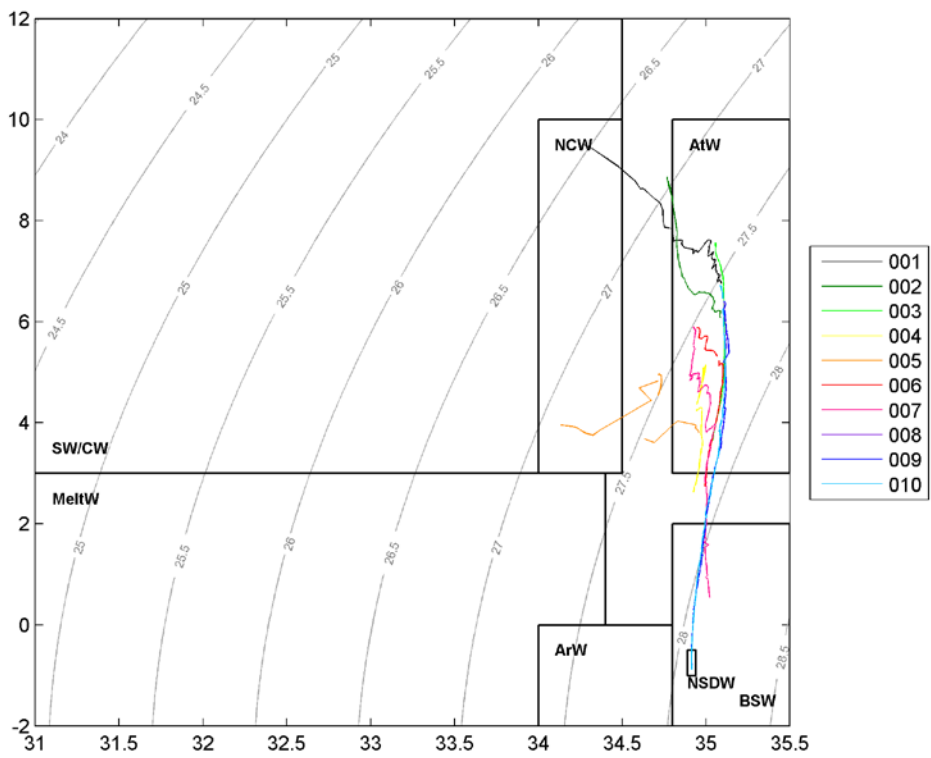

Figure 2.2.9: TS representation of casts 1 to 10.

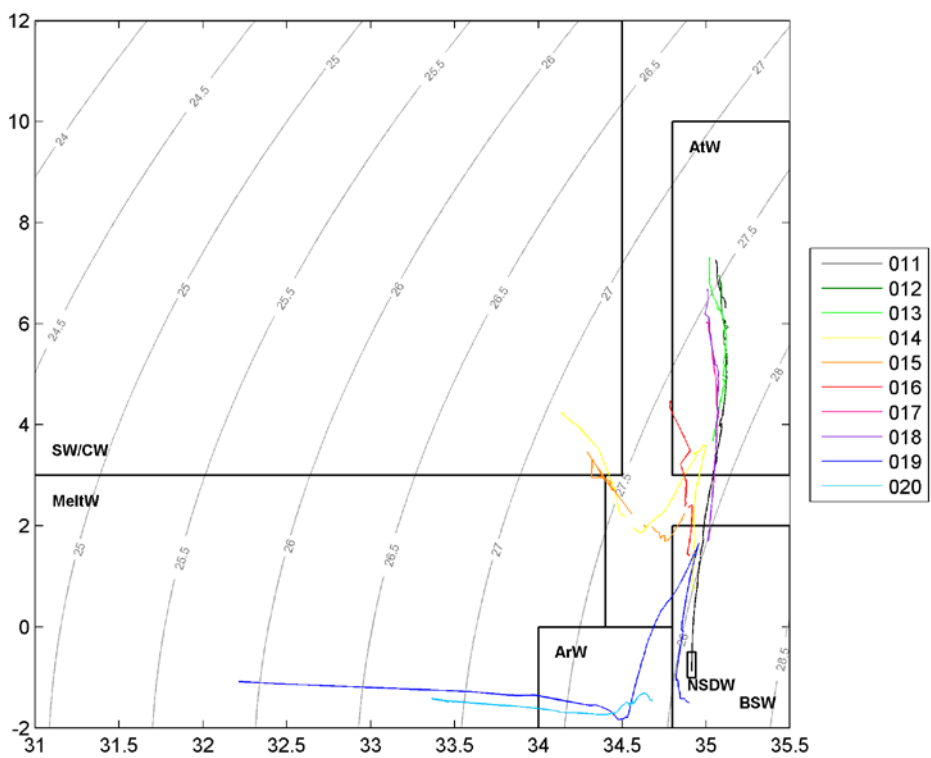

Figure 2.1.10: TS representation of casts 11 to 20.

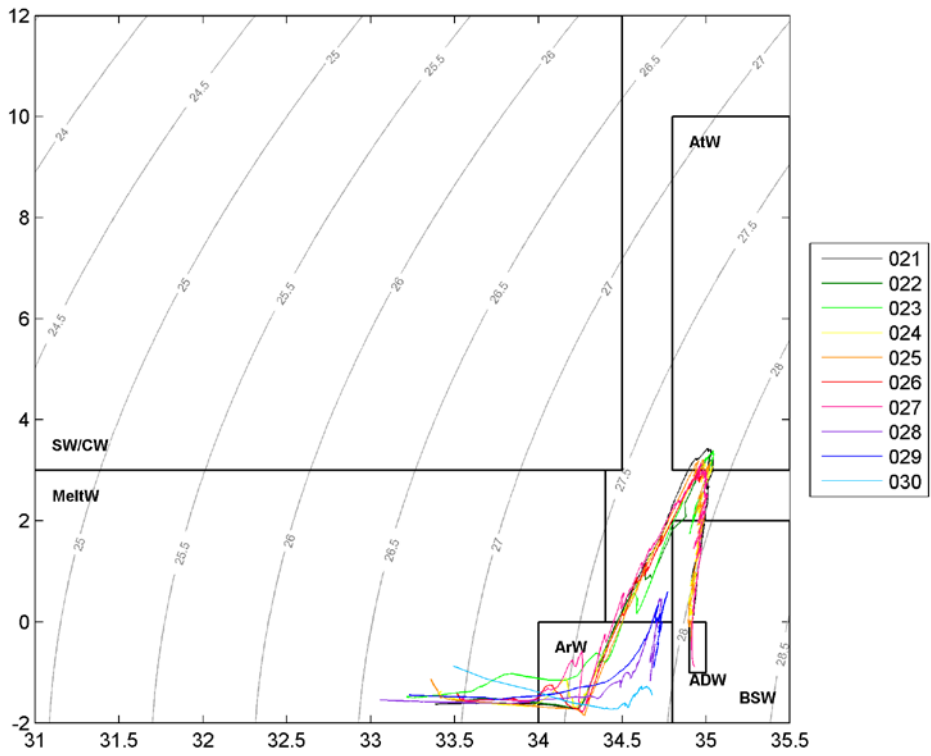

Figure 2.2.11: TS representation of casts 21 to 30.

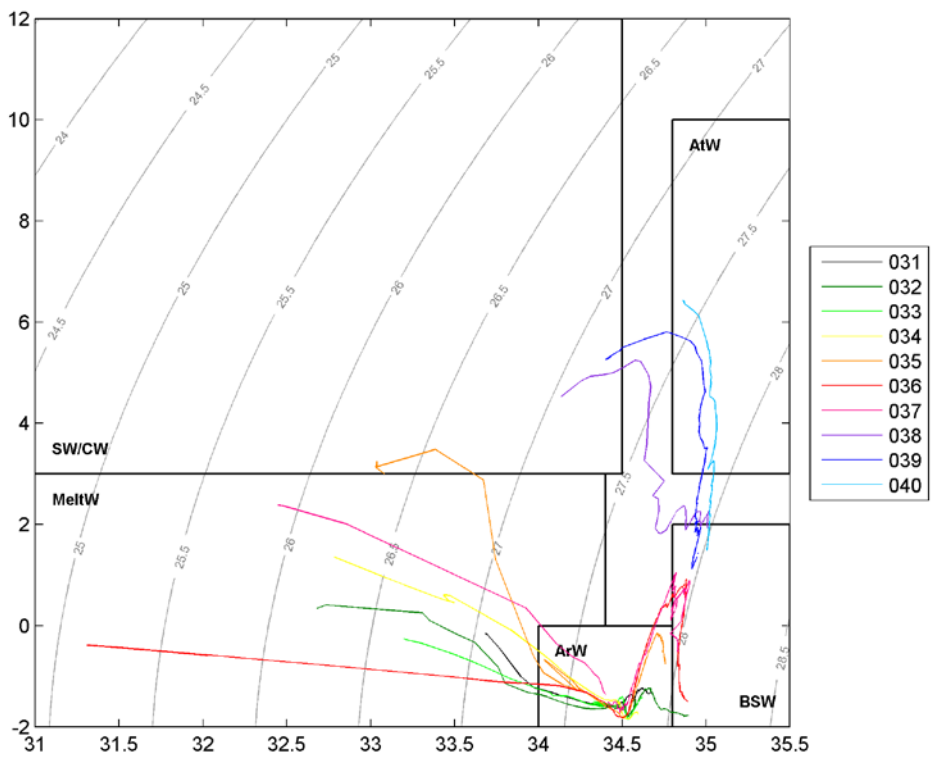

Figure 2.2.12: TS representation of casts 31 to 40.

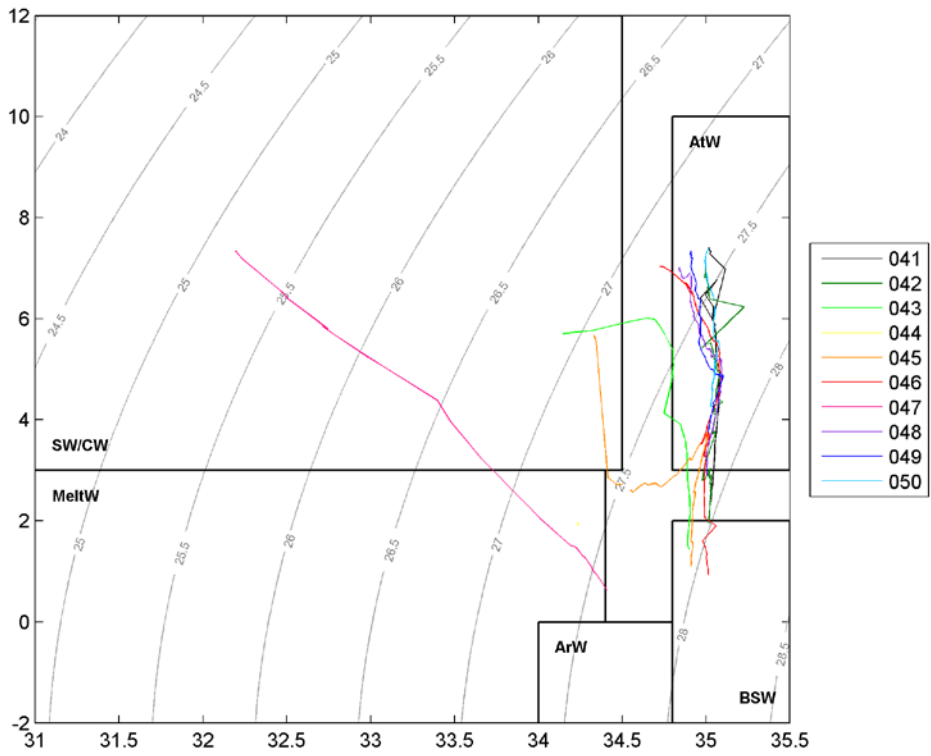

Figure 2.2.13: TS representation of casts 41 to 50.

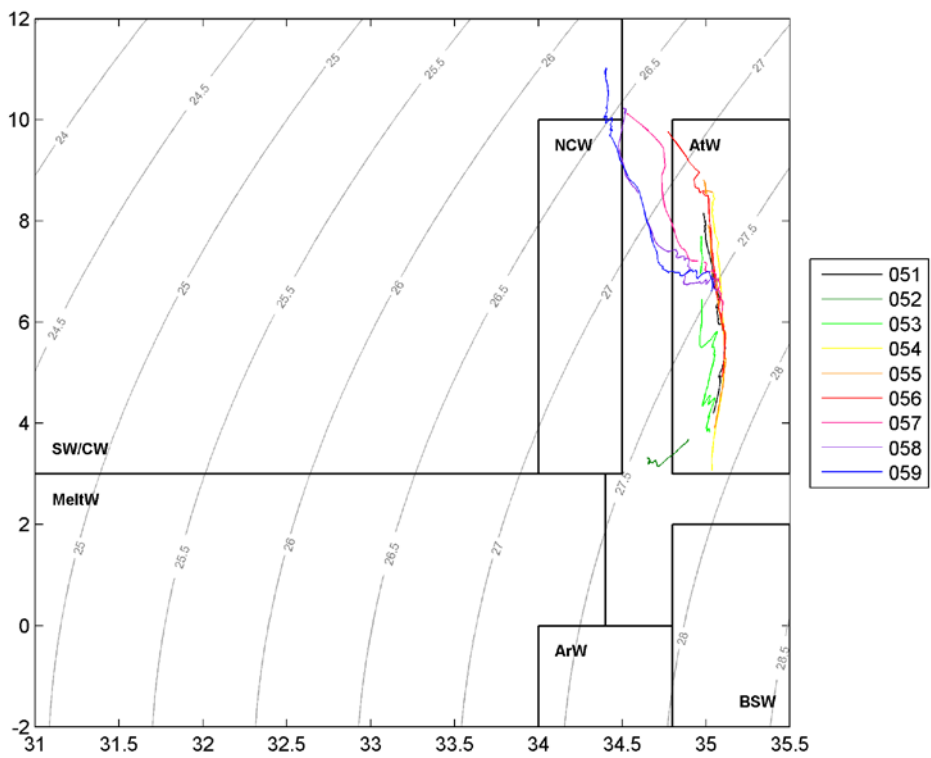

Figure 2.2.14: TS representation of casts 51 to 59.

3) Transects

Several CTD transects were carried out during the cruise (see map on Fig 2.2.15), contour plots of these are shown below.

Notes:

- To allow for easier comparison, the colour scale for each variable is identical on all transects plots. However the data minimum and maximum for each transect might be over the colour scale limits, these are indicated next to the colourbar on each plot.
- Caution must be exercised when interpreting the transect plots, especially near the seafloor where the data interpolation might introduce artefacts.

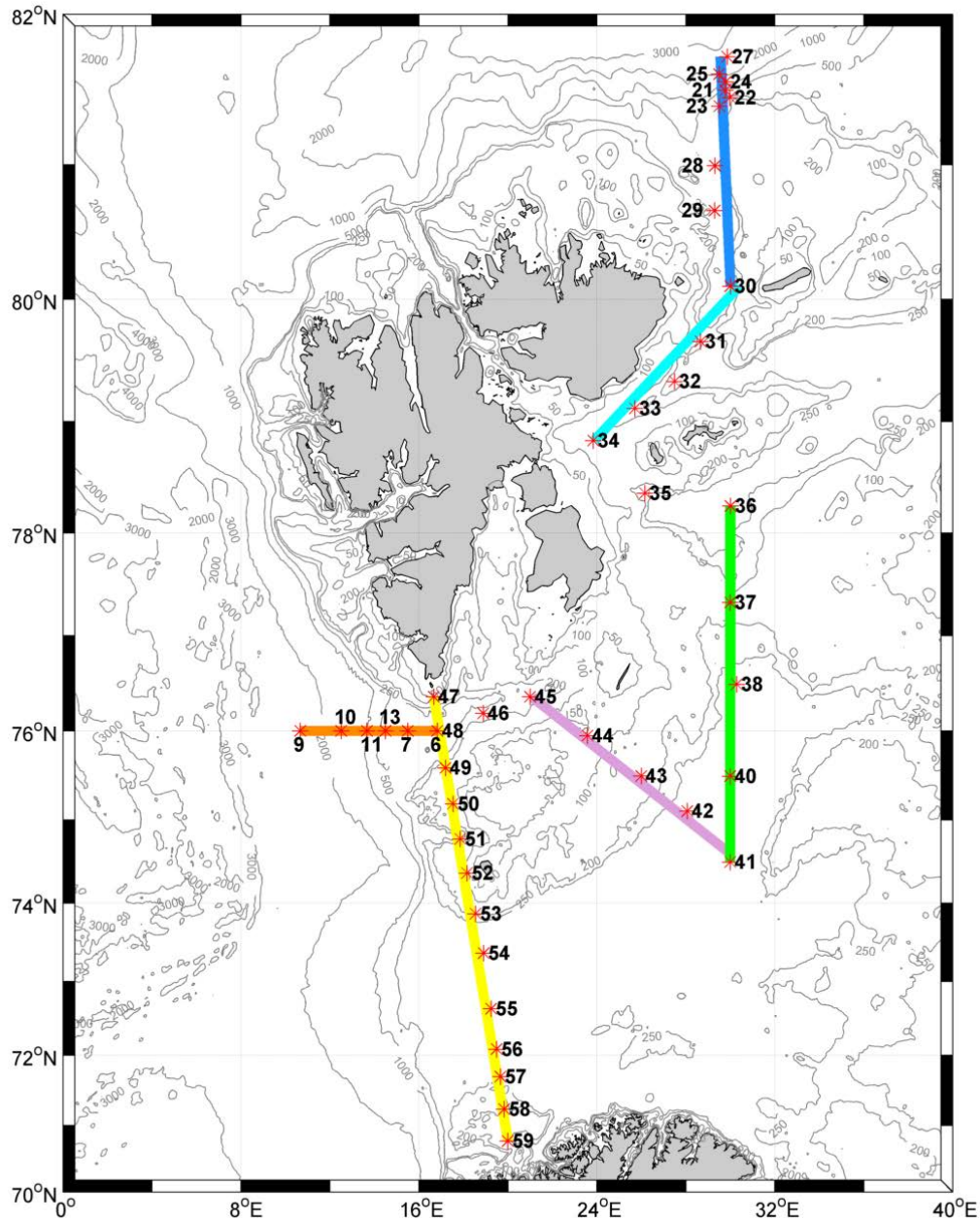

Figure 2.2.15: Map of JR16006 CTD transects. Red stars indicate CTD stations and casts numbers. The coloured lines indicate the transects sections: 1 = yellow, 2= orange, 3 = pink, 4 = green, 5 = cyan, 6 = blue. Bathymetric contours are from the GEBCO Digital Atlas published by the British Oceanographic Data Centre on behalf of IOC and IHO (2003).

Transect 1: Norway to Svalbard, North to South
 Casts (left to right on plots): 47 to 59
 AtW dominating with coastal influences at both ends.

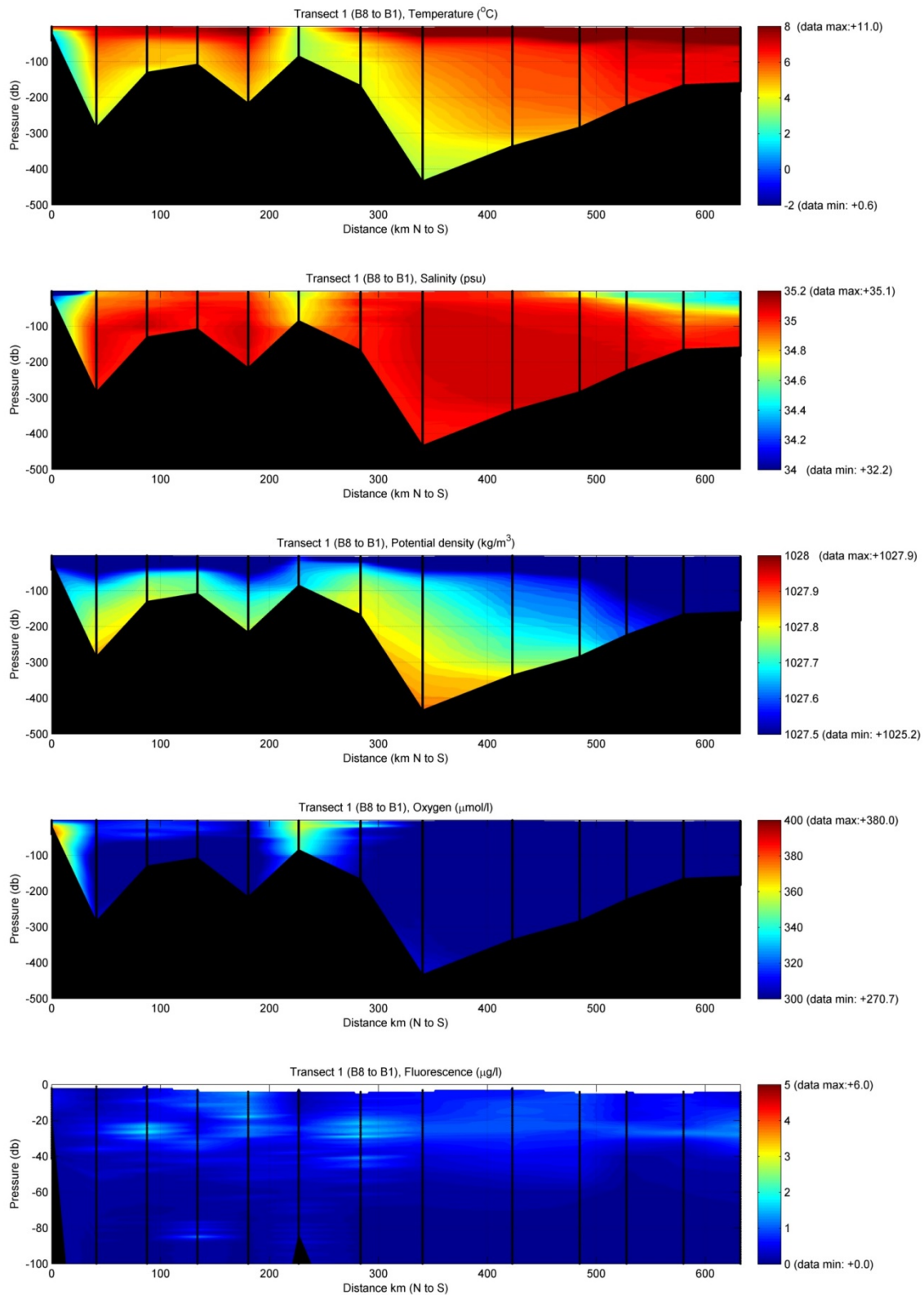

Figure 2.2.16 (top to bottom): contour plots of temperature, salinity, density, dissolved oxygen and fluorescence for Transect 1.

Transect 2: off-shelf, Fram Strait to Barents Sea, West to East

Casts (left to right on plots): 9, 10, 11, 13, 7, 6

AtW on the surface, NSDW at the Western end. Possible BSW presence at depth on the shelf.

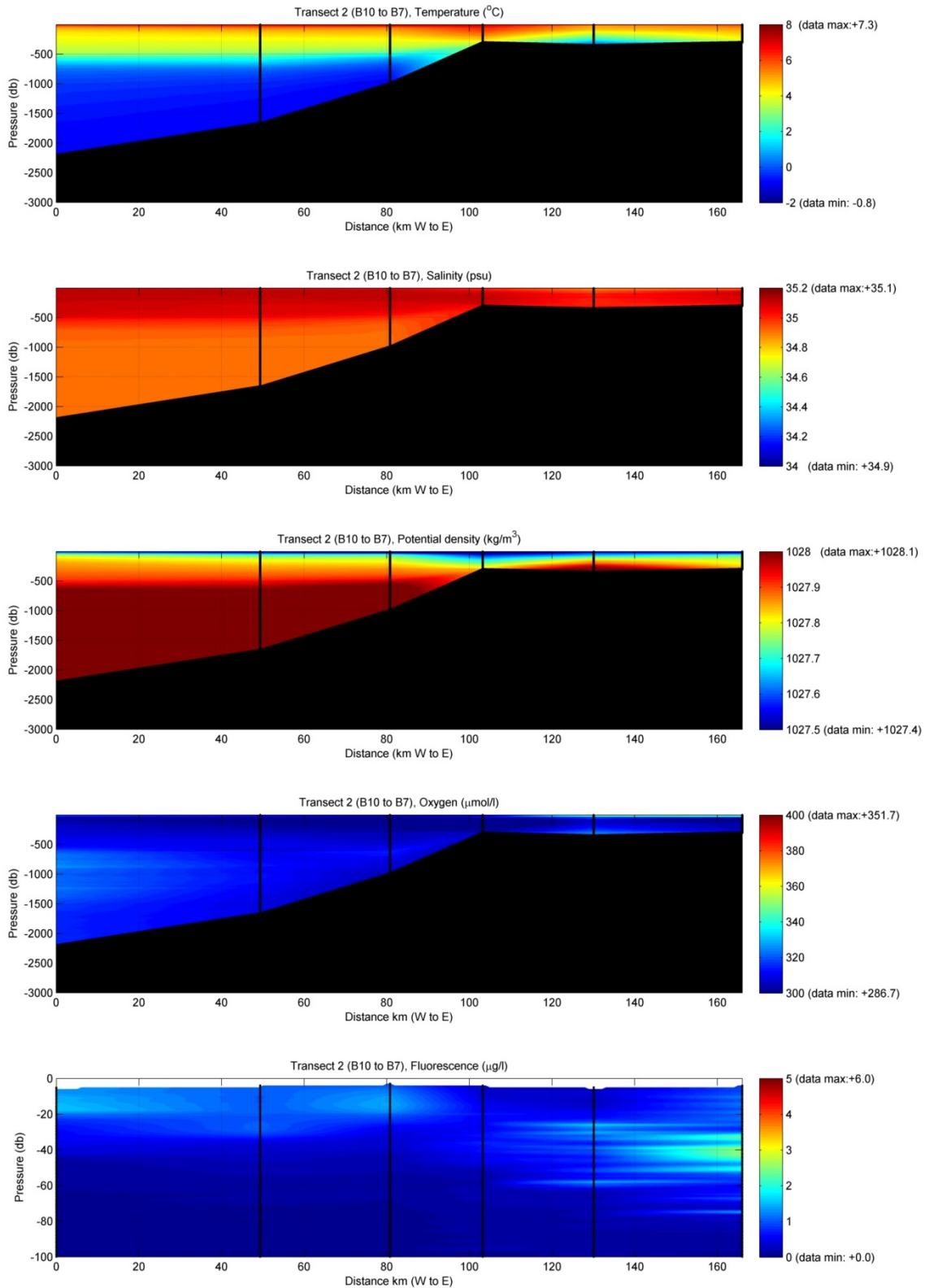

Figure 2.2.17 (top to bottom): contour plots of temperature, salinity, density, dissolved oxygen and fluorescence for Transect 2.

Transect 3: Barents Sea, South of Svalbard, North-West to South-East

Casts (left to right on plots): 45, 44, 43, 42, 41

BSW at depth, overlaid with AtW (or waters of Atlantic origin). At the North-Western end local surface waters probably originating from warmed MW and/or coastal influences.

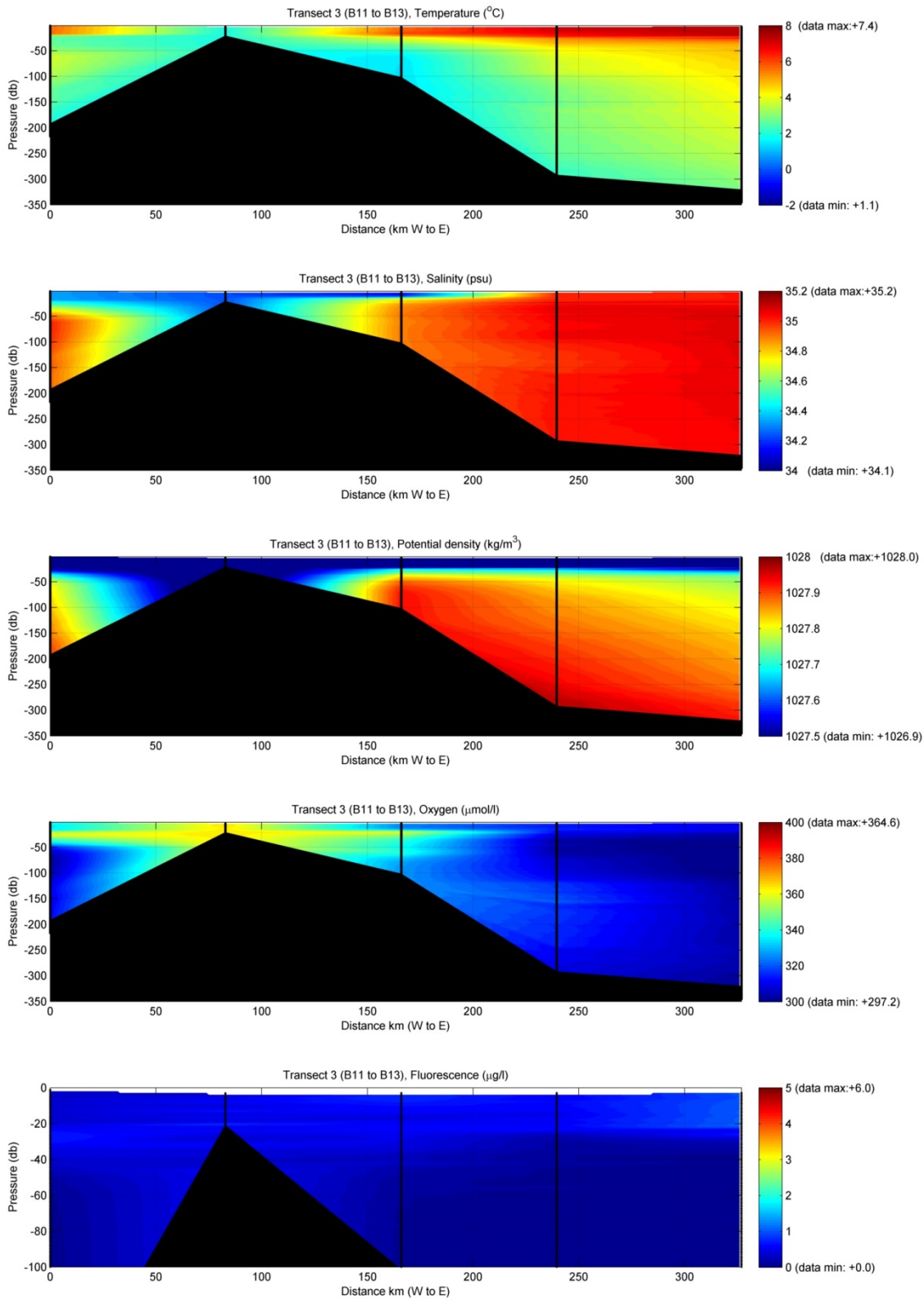

Figure 2.2.17 (top to bottom): contour plots of temperature, salinity, density, dissolved oxygen and fluorescence for Transect 3.

Transect 4: Barents Sea, South of Kong Karl's Land, North to South

Casts (left to right on plots): 36, 37, 38, 40, 41

BSW at depth. In the surface, at the Southern end AtW transitioning to warmed MW, then to AW and MW in ice-covered area at the Northern end.

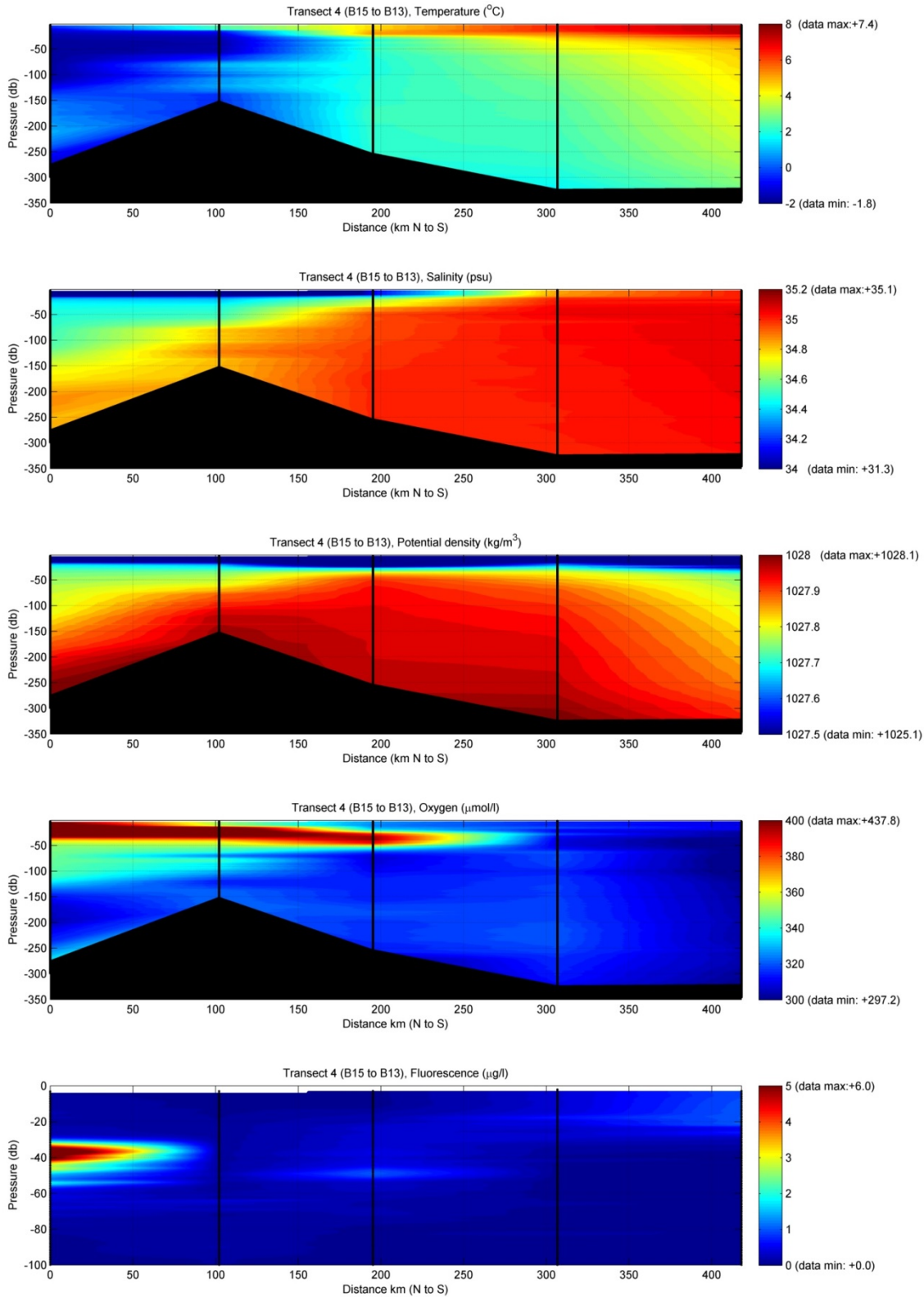

Figure 2.2.18 (top to bottom): contour plots of temperature, salinity, density, dissolved oxygen and fluorescence for Transect 4.

Transect 5: Erik Eriksenstretet, South-West to North-East

Casts (left to right on plots): 34, 33, 32, 31, 30

Ice-covered, MW layer below ice, overlaying ArW. Possible BSW at deepest points of the channel. High dissolved oxygen concentrations, possible coastal influences (?).

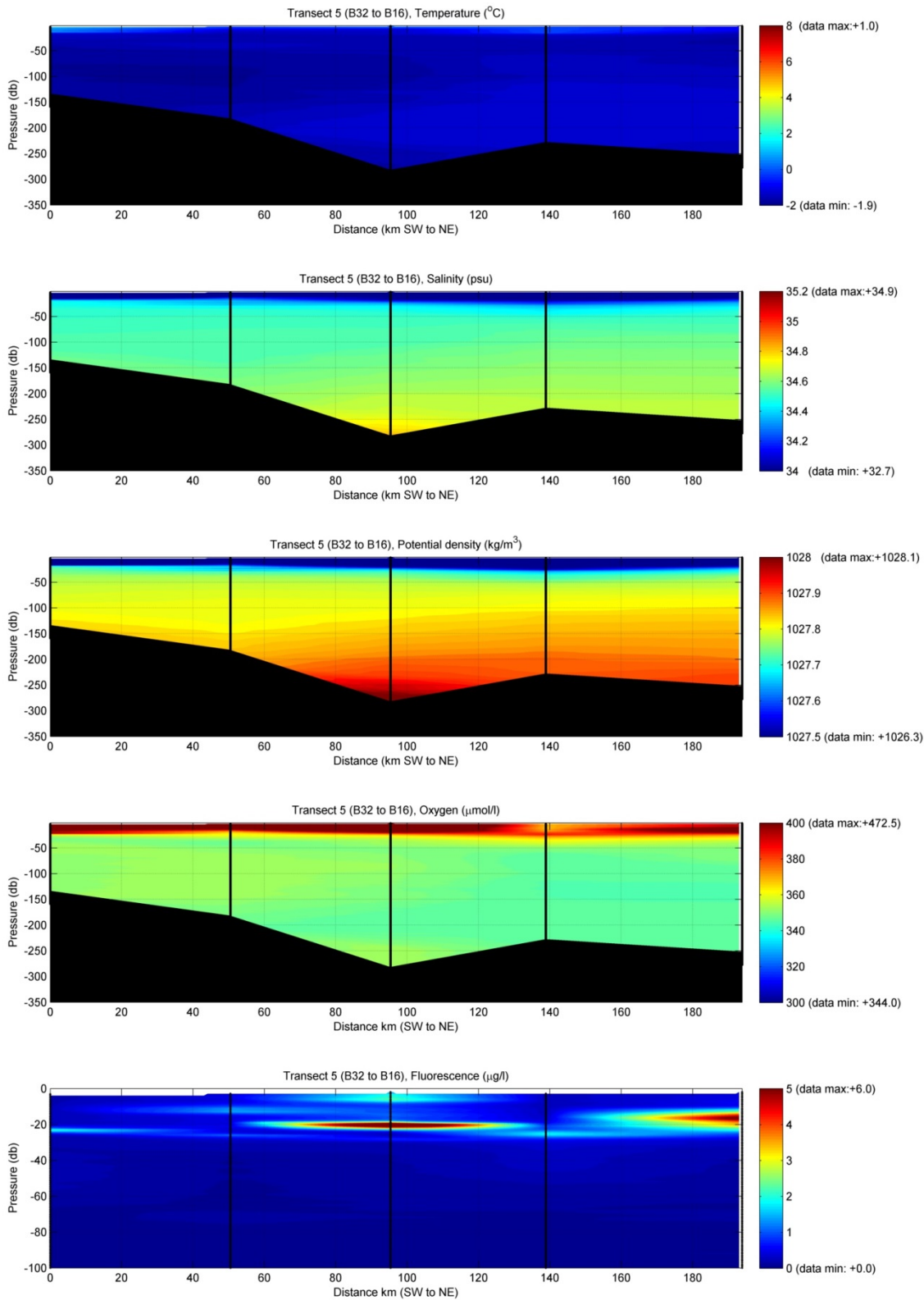

Figure 2.2.19 (top to bottom): contour plots of temperature, salinity, density, dissolved oxygen and fluorescence for Transect 5.

Transect 6: off-shelf, Nansen Basin to Kvitøya, North to South

Casts (left to right on plots): 27, 25, 24, 21, 22, 23, 28, 29, 30

Ice-covered and MW layer. ArW on the shelf, AtW in slope area and beyond (down to ~700m). ADW at depth (>1,000m) when moving further North into the Nansen Basin.

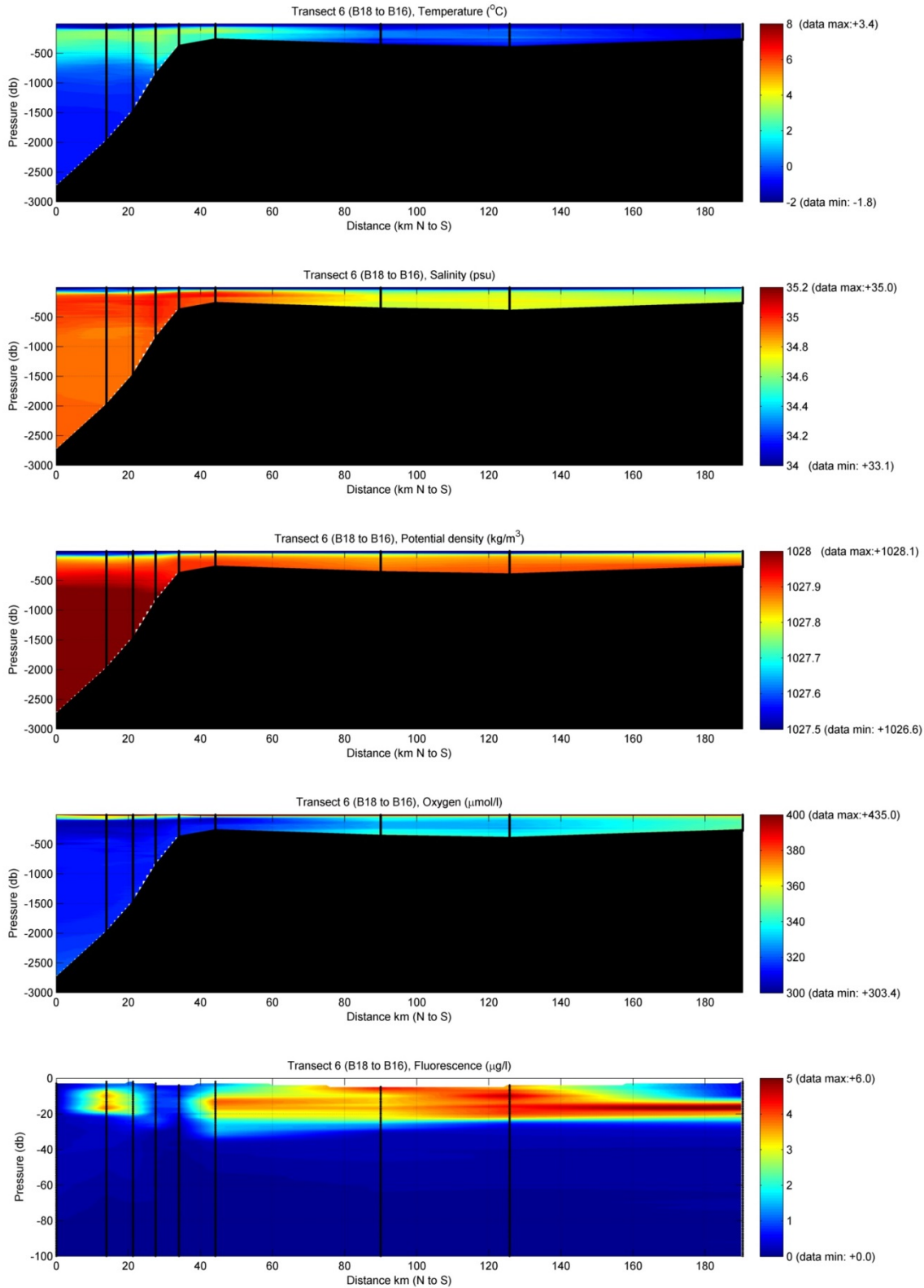

Figure 2.2.20 (top to bottom): contour plots of temperature, salinity, density, dissolved oxygen and fluorescence for Transect 6.

A preliminary map of the water masses encountered during JR16006 is presented in Figure 2.2.21.

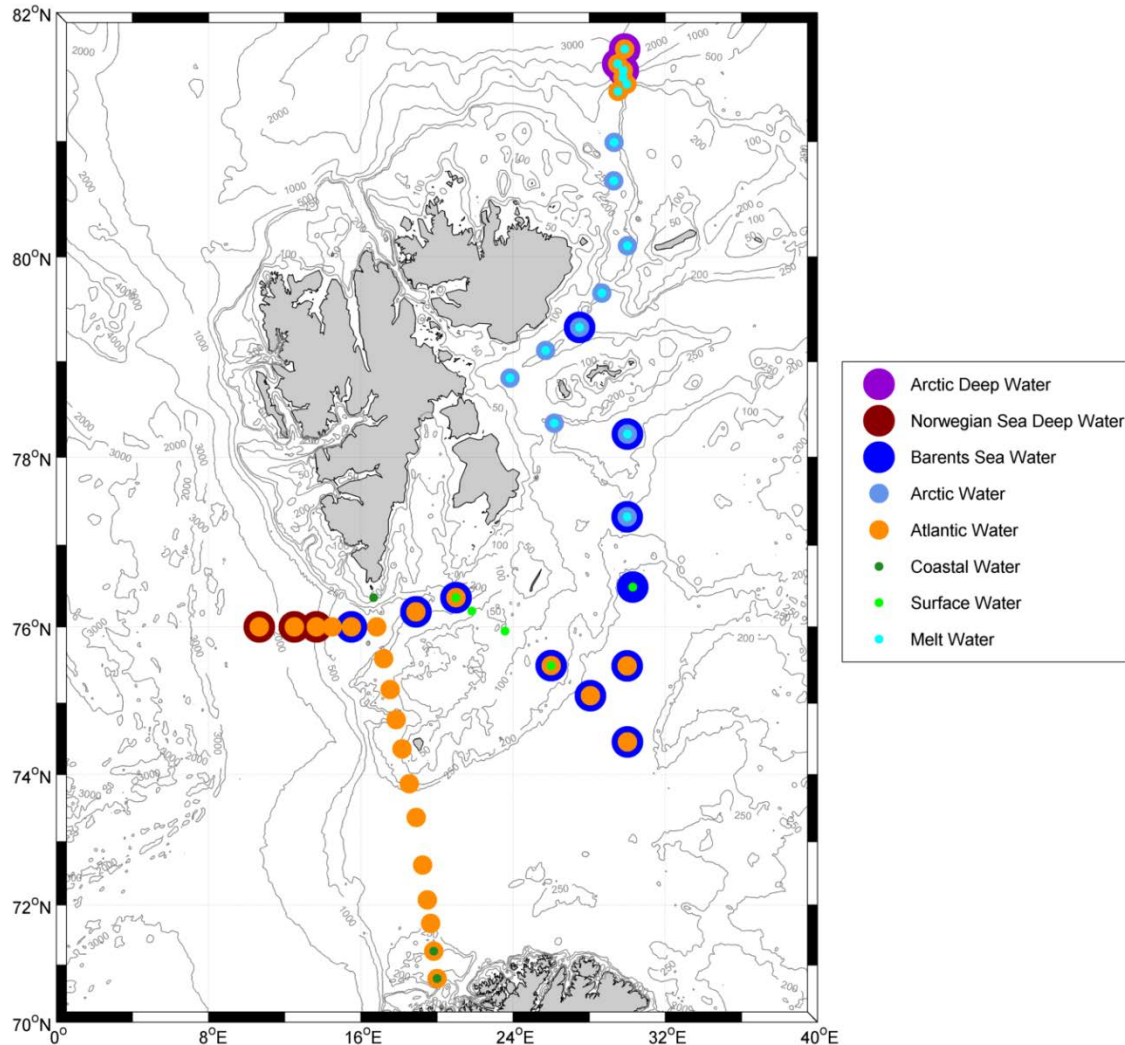

Figure 2.2.21: JR16006 water masses summary map. Bathymetric contours are from the GEBCO Digital Atlas published by the British Oceanographic Data Centre on behalf of IOC and IHO (2003).

References

Oziel, L., Sirven, J., and Gascard, J.-C. (2016): The Barents Sea frontal zones and water masses variability (1980–2011), *Ocean Sci.*, 12, 169-184, <https://doi.org/10.5194/os-12-169-2016> .

Våge, K., R. S. Pickart, V. Pavlov, P. Lin, D. J. Torres, R. Ingvaldsen, A. Sundfjord, and A. Proshutinsky (2016): The Atlantic Water boundary current in the Nansen Basin: Transport and mechanisms of lateral exchange, *J. Geophys. Res. Oceans*, 121, 6946–6960, <http://dx.doi.org/10.1002/2016JC011715> .

Swift, J. H., Koltermann, K. P. (1988): The origin of Norwegian Sea Deep Water, *Journal of Geophysical Research: Oceans* (1978–2012), Vol. 93, No. C4, 3563-3569, <https://doi.org/10.1029/JC093iC04p03563> .

2.3 Underway navigation, sea surface hydrography and meteorology

¹Emily Venables (SAMS)

¹Data set PI and author

Core CAO Programme Data set

Oceanlogger Instrument Serial Numbers

Instrument	S/N Used
Barometer 1 (UIC)	V145002
Barometer 2 (UIC)	V145003
Foremast Sensors:	
Air humidity & temp 1	0020066609
Air humidity & temp 2	0020066752
TIR1 sensor (pyranometer)	161952
TIR2 sensor (pyranometer)	161953
PAR1 sensor	150813
PAR2 sensor	150814
Prep Lab:	
Thermosalinograph SBE45	0018
Transmissometer	C-Star 527
Fluorometer	1498
Flow meter	811950
Transducer Space:	
Seawater temp 1 SBE38	0767
Seawater temp 2 SBE38	0771

Processing

This section describes the underway data acquisition and processing during JR16006, bringing together navigation data with routinely measured sea floor depth, meteorological and sea surface hydrographic parameters. Figure 2.3.1 shows the bathymetry along the cruise track.

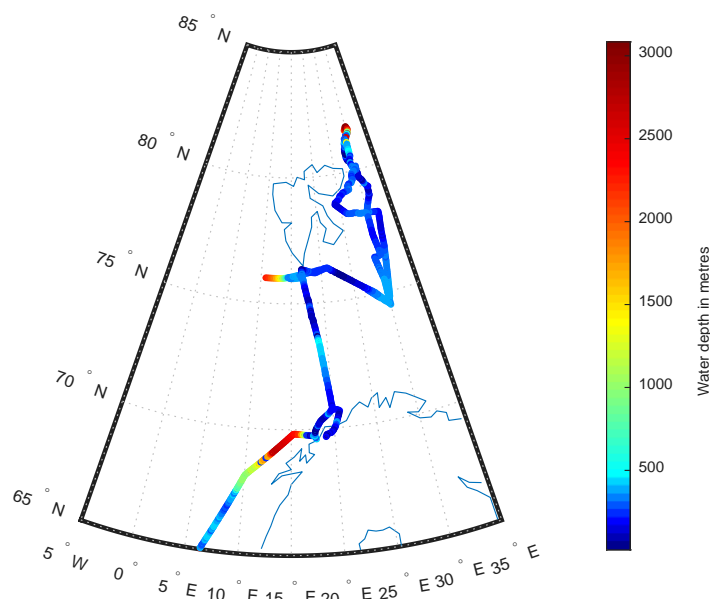

Figure 2.3.1: Cruise track showing echo sounder bathymetry

Instrument set-up

The oceanlogger system recorded the sea surface and most meteorological parameters. Anemometer, echosounder and position data came in from separate streams. Table 2.3.1 lists all those that have been extracted and processed. Serial numbers are listed above. In all cases, data were received in csv format as *.ACO files. Column headings and units were listed in a corresponding .TPL file, each timestamped at time of recording in the format ‘YYY DDD HH:MM:SS’. There was a discrepancy between the TPL metadata files and the output channel numbers format. This was resolved by working out which output channels corresponded to which sensors.

Data have been processed from when the oceanlogger system and underway pumps were turned on until the end of the cruise: 30th June 2017, day 181, until 9th August 2017. Pumps were switched off in sea ice, so periods of no flow and a lag of 60 data points after restart have been removed from the data.

Table 2.3.1: Underway instrument channels processed and used in this report.

Instrument	Parameter	Unit
Oceanlogger	airtemp1	celsius
	humidity1	%RH
	par1	Umol/S.m2
	tir1	W/m2
	airtemp2	celsius
	humidity2	%RH
	par2	Umol/S.m2
	tir2	W/m2
	baro1	hPa
	baro2	hPa
	tstemp	celsius
	conductivity	S/ma
	salinity	psu
	sound velocity	m/sa
	transmittance	0<Tr<1
	flowrate	l/min
	sstemp1	celsius
sstemp2	celsius	
fluorescence	ug/l	
Anemometer	Wind direction	degrees
	Wind speed	m/s
	Wind speed	knots
Echosounder EA600	Depth	metres
Furuno GPS	Latitude	degrees
	Longitude	degrees
Ashtech GPS	Latitude	degrees
	Longitude	degrees
	Heading	degrees
	Pitch	degrees
	Roll	degrees
Seatex GPS	Latitude	degrees

	Longitude	degrees
	Heading	degrees
Gyro	Heading	degrees

Navigation

Unfortunately, the navigation system on board was problematic on this cruise. The primary (generally most accurate and reliable) Seatex system started to fail on 14th July. At this point there were just occasional heading dropouts, but the system failed completely with loss of position data on 23rd July. From this point onwards (11:00 GMT 23/07/17), the navigation data stream to the ADCP and all logging software including the lab displays was supplied by a combination of Ashtec, Furuno and Gyro data. After day 215, the Seatex output files started to contain spurious extra ‘<’ characters, causing the processing scripts to crash. For this section, just the Furuno data are used. Figure 2.3.2 shows the offset between the heading from the Furuno system and the heading from the gyro system. Problems are indicated from 9th July, with errors growing after 14th July and an eventual failure on 23rd July.

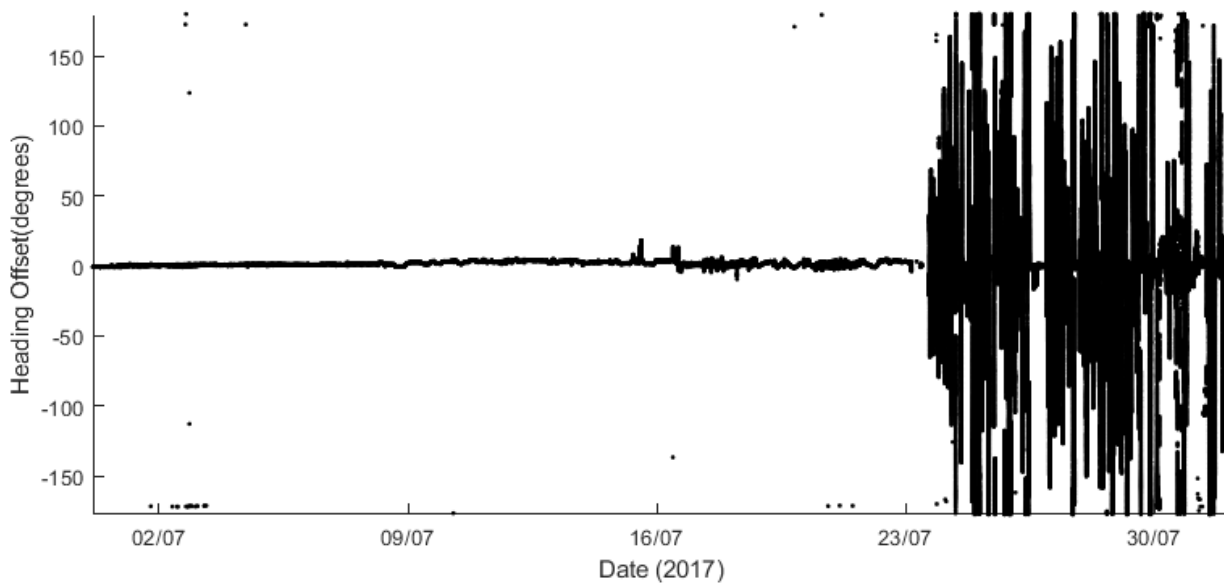

Figure 2.3.2: Offset between Furuno and Gyro vessel heading.

Bathymetry - Echo sounder EA600

The Bathymetric data were often very noisy, with spurious dropouts and artefacts. A moving median and standard deviation filter was applied in order to clean the data before applying minute averaging.

First pass window size 1000 points, disregard data outside median ± 1.1 standard deviations.

Second pass window size 120 points, disregard data outside median ± 1.5 standard deviations.

Third pass window size 60 points, disregard data outside median ± 1.5 standard deviations.

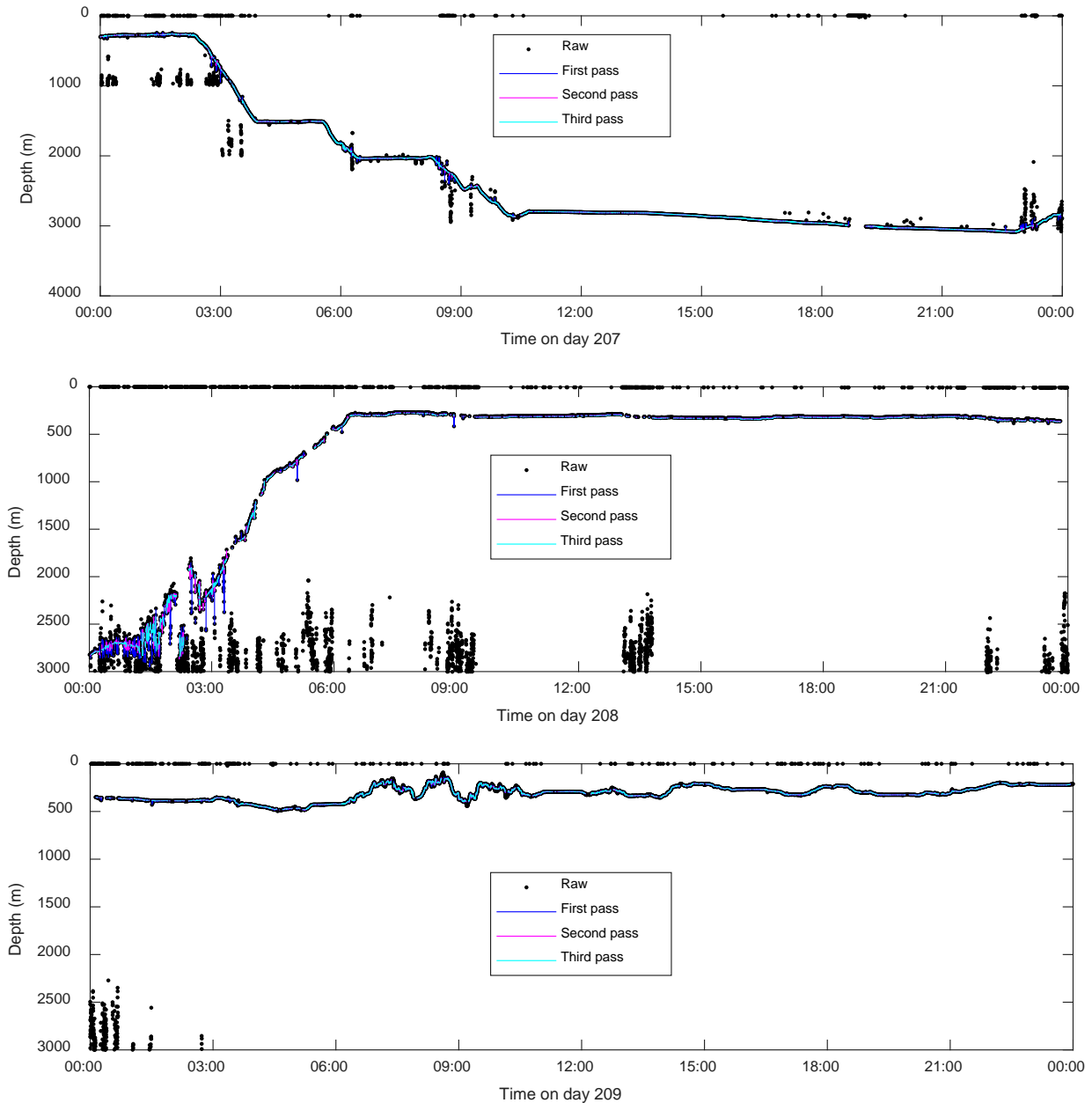

Figure 2.3.3: 3 days of raw and filtered echosounder data

Meteorological Data

Meteorological data were recorded throughout the cruise, saved as daily raw files and as a minute-average for the entire dataset. There were some issues with the wildlife in that seagulls enjoyed sitting on the PAR sensor. Wind speed data from the anemometer are also questionable. Values look to be too high for the conditions experienced. There were two channels for TIR, one of which did not work for the entire cruise.

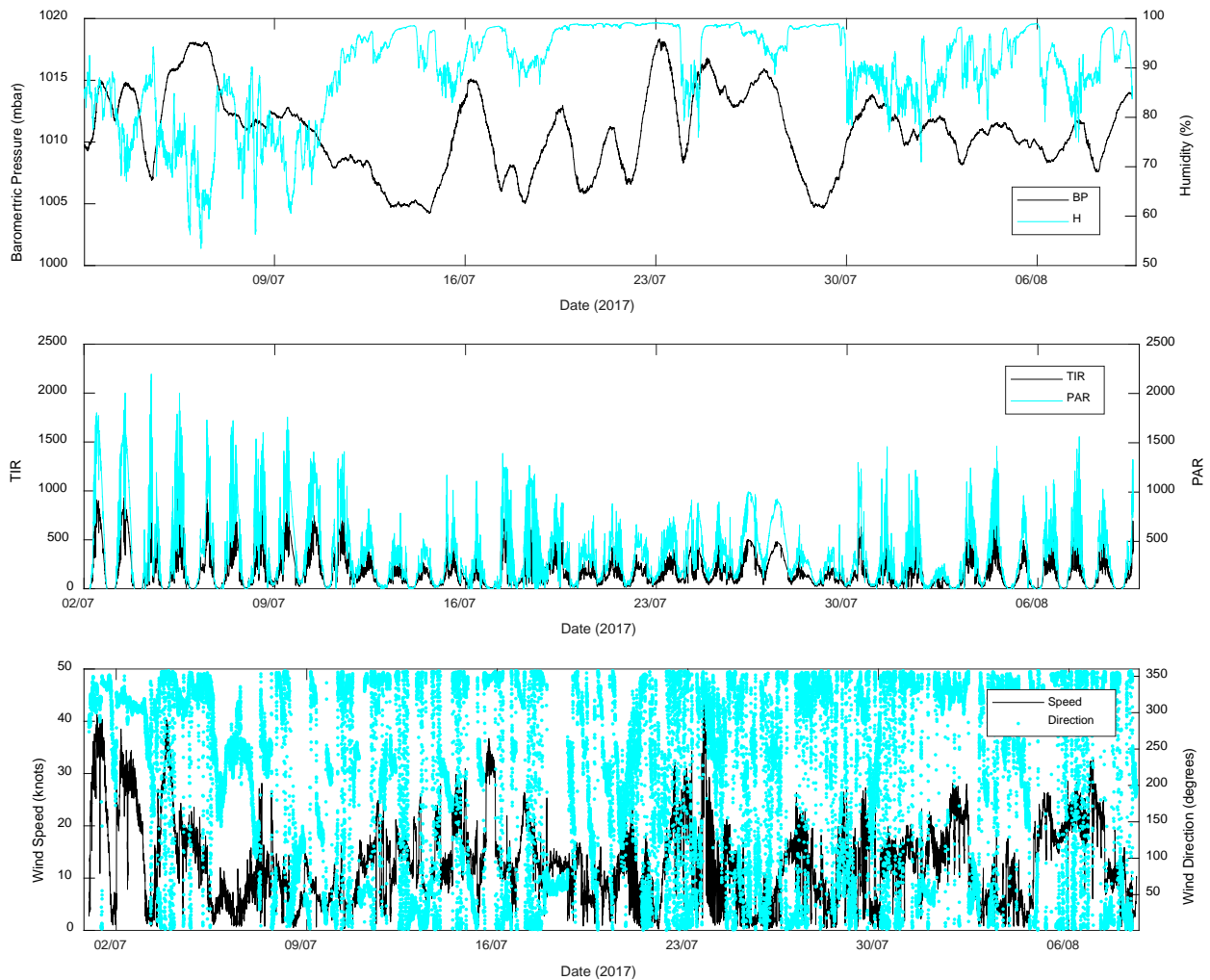

Figure 2.3.4: Meteorological data. (Top) Pressure and humidity, (Middle) PAR and TIR, (Bottom) Wind speed and direction

Turbidity and Fluorescence

The periods when seawater pumps were turned off because of sea ice appeared to have lasting effects on the fluorometer sensor. It is possible that stagnant water allowed for the build-up of chlorophyll on the sensor, causing chlorophyll values recorded by the sensor to rise steadily throughout the cruise. The sensor was removed and cleaned once truly unbelievable levels were reached, but data are questionable after the first period of no flow on 21st July.

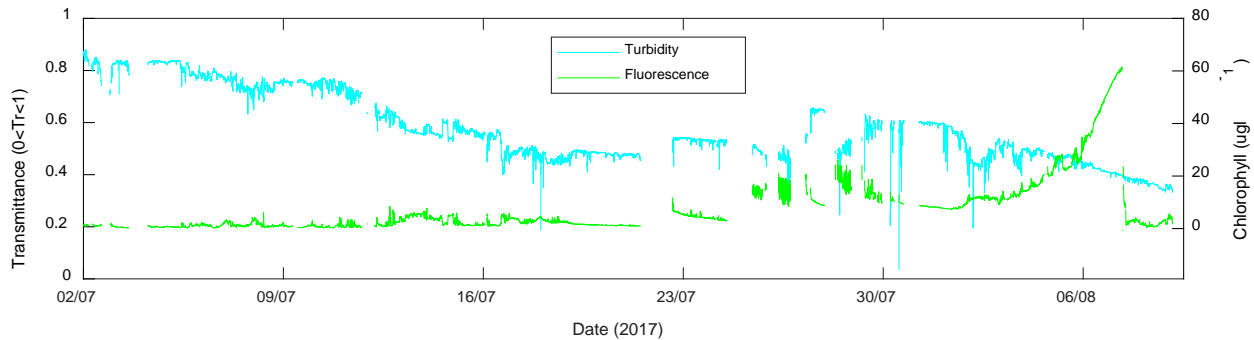

Figure 2.3.5: Surface chlorophyll and transmittance.

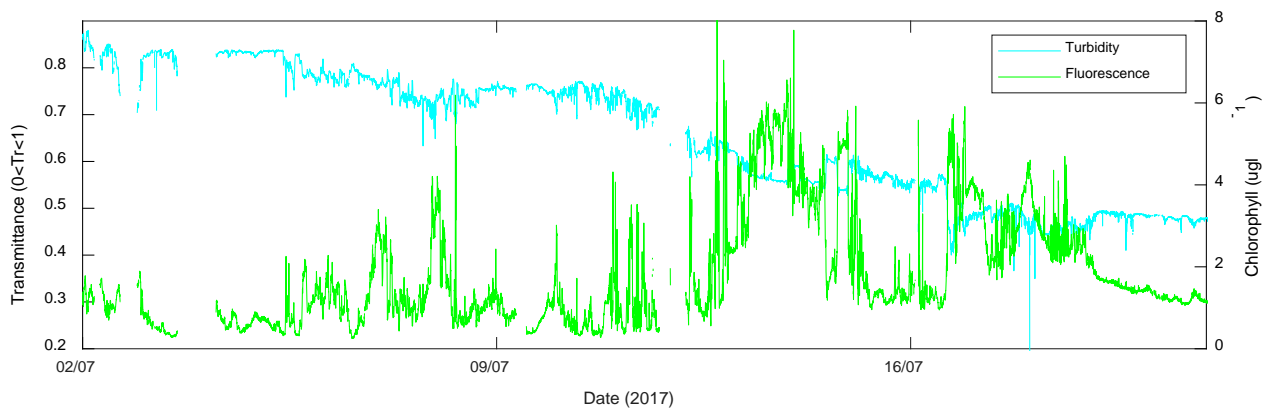

Figure 2.3.6: Surface chlorophyll and transmittance before pumps were turned off.

Sea Surface Hydrography

Surface water parameters from the ocean logger system were also saved as daily raw files and as a minute-averaged time series. Data from times of no flow, and from a lag time of 5 minutes afterwards (60 data points) were removed. A filter was applied to the salinity data using a moving window median and standard deviation with a window size of 120 data points for the first pass and 60 for the second. Salinity data outside the limits of the median ± 1.5 standard deviations were rejected. An offset was applied from salinometer calibrations as described in the next section. The notable salinity minimum on July 8th corresponds with being in Tromsø.

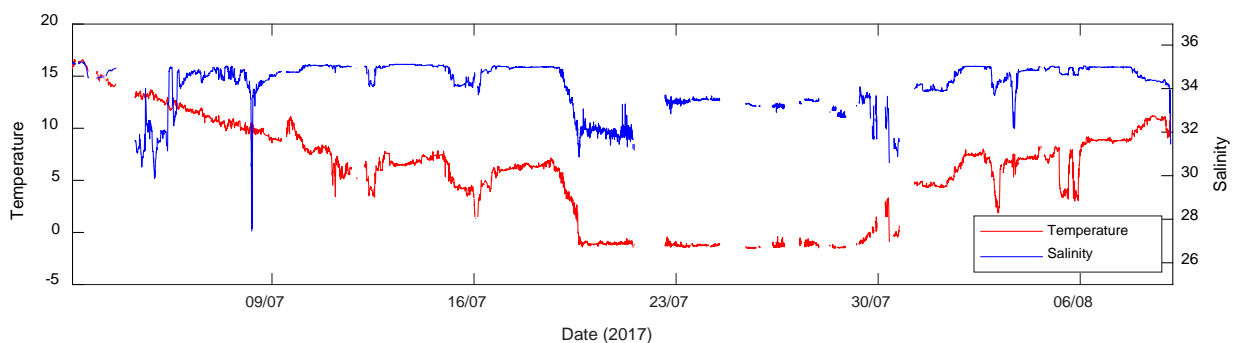

Figure 2.3.7: Surface temperature and salinity.

Underway conductivity calibration

Estelle Dumont (SAMS)

119 discrete salinity samples were taken from the underway system every 6 hours during the cruise (when the pumps were running). For each sample the bottle was rinsed 3 times with the running seawater, filled, plastic insert fitted, bottle neck wiped, and lid put on. Once a crate of 24 samples was full, it was placed in the Autosal laboratory to acclimate to temperature for at least one day prior to analysis. At the start and end of each crate a standard seawater (SSW) sample was analysed, enabling to monitor the drift of the instrument. No clear drift pattern was visible, although the readings varied between -0.003 and $+0.002$ psu from the theoretical value. For each crate, the average of the two SSW offsets was used as the offset to correct the Autosal readings. The conductivity from the TSG was then plotted against the corrected Autosal readings (Fig. 2.3.8 and 2.3.9).

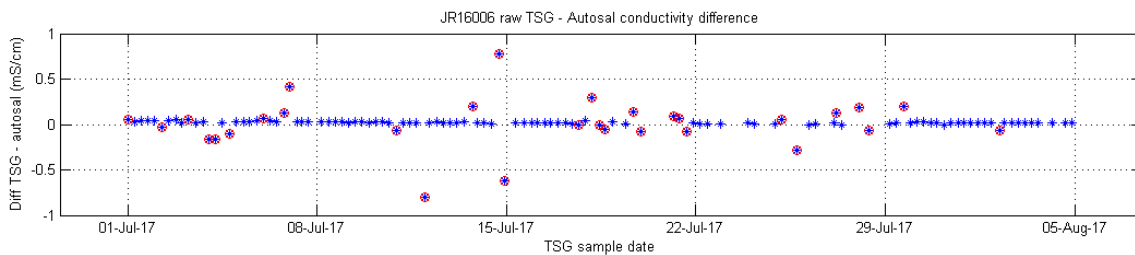

Figure 2.3.8: difference between the raw TSG and Autosal conductivity readings in time, all values

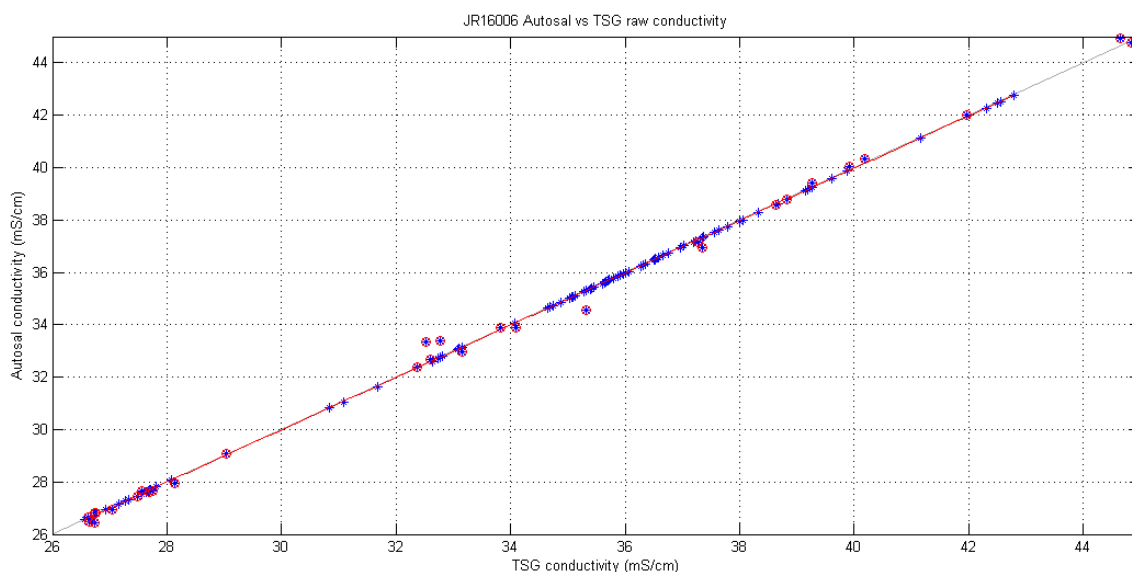
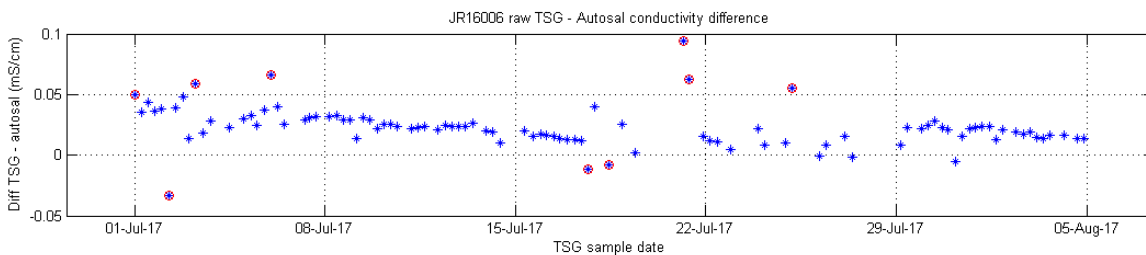

Figure 2.3.9: Top: difference between the raw TSG and Autosal conductivity readings in time, close-up. Bottom: raw TSG vs Autosal conductivity readings. Outliers indicated by red circles.

The median and standard deviation of the differences between the raw TSG and the Autosol readings were calculated, and all readings with a difference larger than 0.2 standard deviations of the median were excluded from the dataset (30 points, or 25%). A linear regression was run on the remaining data points, and the final calibration equation was determined to be:

$$\text{cond}_{\text{calib}} = 0.9984 * \text{cond}_{\text{raw}} + 0.0339$$

$$(R^2 = 1)$$

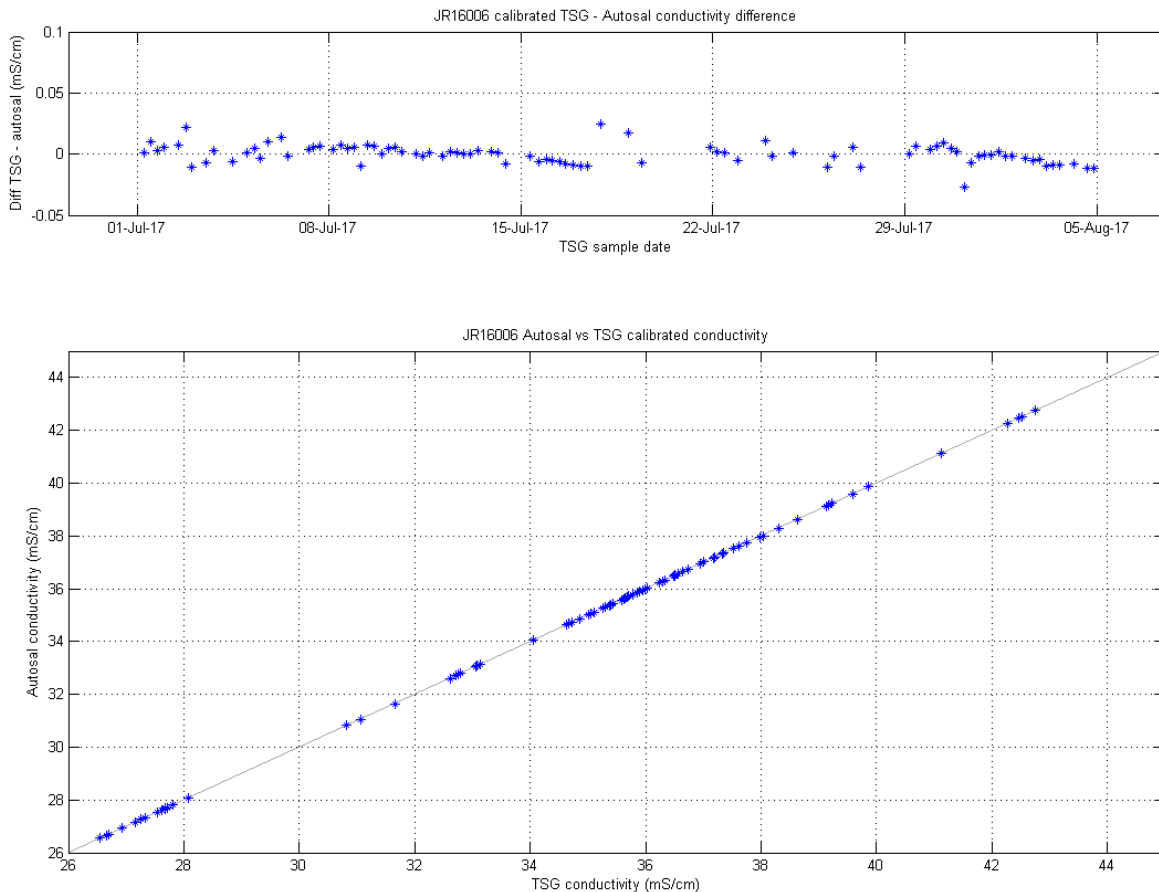

Figure 2.3.10: Top: difference between the corrected TSG and Autosol conductivity readings in time, close-up. Bottom: corrected TSG vs Autosol conductivity readings.

The middle part of the dataset (~ 18th to 28th July) appears very noisy, this is likely due to the presence of ice around the ship and the pump system being turned off and on regularly.

After applying the calibration coefficients to the sample data, the TSG seemed to show a downward drift in the conductivity readings at times (15th – 18th July, and 2nd – 5th August). This remains unexplained, and future users of the TSG data might wish to investigate this further before using the calibrated data.

2.4 Lowered ADCP

^{1,2}Marie Porter (SAMS), ¹William Clark (BAS)

¹Author, ² Data set PI

Background and objectives

Velocity profiles were collected at each CTD station, giving instantaneous water velocities for the CTD samples and bottom velocity values for the benthic work. These profiles will be further processed to produce shear variance, dissipation and vertical velocities where appropriate.

Sampling strategy/instrument description

Lowered Acoustic Doppler Current Profiler (LADCP) data were obtained from every CTD cast. A pair of 300 kHz RDI 'Workhorse' LADCP were deployed on the frame with one looking upward and one downward. The upward looking ADCP behaved as a slave to the downward looking one. The ADCPs were set with 1.3s ensembles in 2.8s bursts and averaged into 4 m bins.

Methods/Processing/Calibrations

Each of the profiles were processed by the end of the cruise. The profiles have been processed using 'Visbeck' routines recently adapted and improved (A.M. Thurnherr, 2016, 'How to process LADCP data with the LDEO software') and identified as LDEO version IX.12. They were combined with CTD data to provide accurate information on vertical velocity of the frame through the water, and with the ship's navigation data to calculate its exact position in the water using the ship as a reference. Each processed cast is listed in Table ** along with the depth of that cast, the station number and comments about it.

Data quality notes/ problems

There are undiagnosed problems relating to the failing of the "slave" unit intermittently throughout the cruise and with the beams of the "master" unit near to the end of the cruise (casts 49-51). The cable harness was replaced after the beam failures and over the few dives between this and the end of the cruise the problem did not return.

Results

The data have been processed to give velocity profiles throughout the water column. We see evidence of the variance currents in the region (for example the Slope Current, the Bear Island Current and the Atlantic Current). The profiles have not been de-tided and as such are not currently representative of the local mean currents.

An example of the data produced here is provided below (Figures 2.4.1 & 2.4.2) and shows the changes associated with the use of the ship's navigational data on the profile.

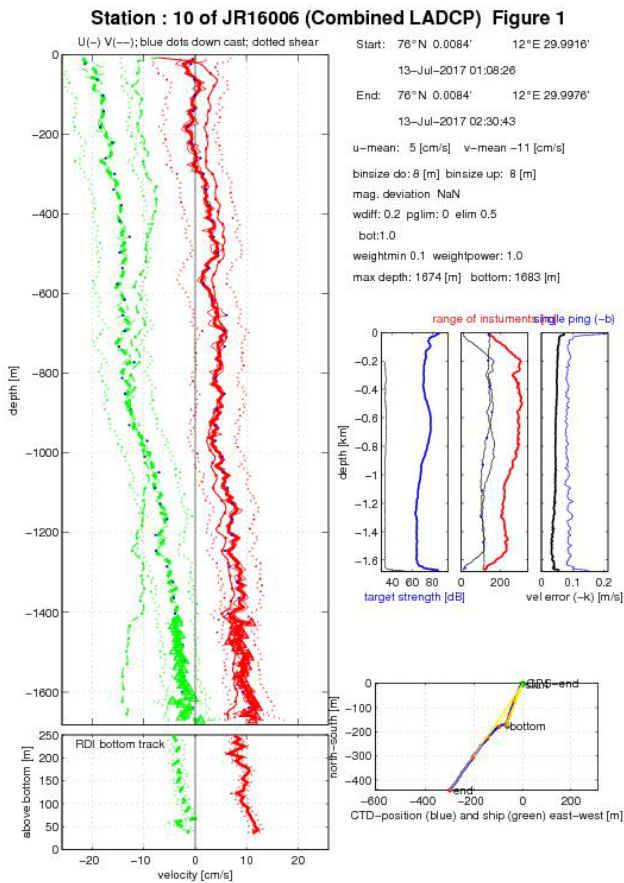

Figure 2.4.1. Profile number 10 as processed with the LDEO software including all CTD and navigational data

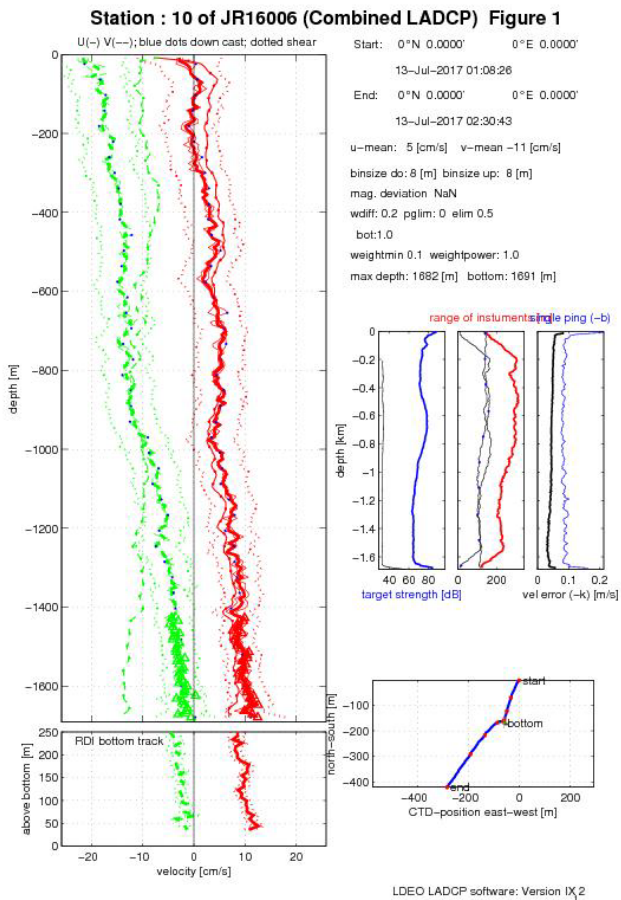

Figure 2.4.2. The same profile number 10 with no navigational data input. While the differences are minor they are apparent and may be significant for any further processing, part

2.5 Vessel-Mounted Acoustic Doppler Current Profiler (VMADCP)

^{1,2} Jo Hopkins (National Oceanography Centre, Liverpool)

¹Author, ² Dataset PI

Instrument description

The 75 kHz RD Ocean Surveyor (model 71A-1029-00) fitted into the ships hull was used to collect water current velocities over a range of depths. It transmits high frequency acoustic signals which are backscattered from plankton, suspended sediment, and bubbles, all of which are assumed to be travelling with the mean speed of the water. The ADCP estimates horizontal and vertical velocity as a function of depth by using the Doppler effect to measure the radial relative velocity between the instrument and scatterers in the ocean.

The transducer head is mounted 6.3 m below the waterline and beam 3 is rotated 60.08° relative to the ships centreline. A nominal rotation of 60.08° (misalignment angle) is therefore necessary to remove the ships velocity from the data. Fine tuning of this misalignment is performed in Matlab post-processing routines.

Data Acquisition and configuration

The ADCP was controlled using the proprietary RD VmDas software, version 1.42.

The VmDas software creates a series of raw files needed for processing:

- .ENR binary file of beam coordinate, single ping data
- .N1R ascii file with the NMEA telegram and ADCP time stamp
- .VMO ascii file with VmDas configuration

Additional files output are:

- .ENS binary file with beam coordinate single ping data and NMEA data
- .NMS binary file of navigation and attitude
- .ENX binary file of earth coordinate, single ping data
- .STA binary file of earth coordinate, short time average data
- .LTA binary file of earth coordinate, long time average data
- .LOG ascii file with record of ADCP communication and VmDas errors

.ENX, .STA and .LTA files can be read by the WinADCP software.

NMEA strings were fed to the VMDas software from the *Navigation Repeater* and output in the .N1R files. There were:

\$PADCP,1,20170702,071419.32,0.38

Time stamp from the VmDas software every time the ADCP pings
Ensemble number, PC date, PC time, PC clock offset in seconds*

**VmDas keeps a record of the date/time of GGA messages by recording the date/time according to the PC clock when the message is read, and calculating the offset between the times in the PC clock and the GGA message. If the clock offset is added to a GGA message time, the result is a local PC time. The offset corrects for the difference in time zone between local PC time and GGA time (UTC) and any errors because the two clocks are not perfectly synchronised.*

\$PRDID,0.04,-0.91,314.13

Ships, pitch, roll and heading from SeaTex, the primary navigation and attitude feed on the ship

\$INGGA,071419.72,5509.864986,N,00344.917201,E,2,08,1.0,-3.19,M,46.02,M,2.0,0120*7B

Time, position and fix from SeaTex, the primary navigation and attitude feed on the ship

\$INVTG,315.17,T,,M,3.8,N,7.0,K,D*25

Track made good and ground speed (relative to the ground)

With the exception of one file (#5) recorded in deep water off the shelf edge, the following bottom tracking command file was used:

JR 500m BottomTrack 8mBins NOT ThruSSU.txt

Narrow band (low res.)

65 x 8 m bins

Ambiguity velocity 390 cm/s

8 m blanking distance

1 second ensembles

0.5 secs between bottom track and water pings

Bottom track on (500 m)

The following water tracking file was used for file #5:

JR 800m WaterTrack 16mBins NotThruSSU.txt

Narrow band (low res.)

Water track mode

50 x 16 m bins.

Ambiguity velocity 390 cm/s

8 m blanking distance

Ping as fast as possible

Bottom track off

Set to ping as fast as possible.

Table 2.5.1. Dates/times and positions of the files recorded as they were opened (O) and closed (C).

Date Time	Latitude	Longitude	Depth (m)	Filename	O/C	Comment/Config.
14/08/2017 07:03	52.05544	2.63911	38.21	JR16006025	C	
10/08/2017 07:42	66.86886	8.31365	264.47	JR16006025	O	Back onto Seapath !!!
10/08/2017 07:41	66.86886	8.31365	264.47	JR16006024	C	Last few minutes may be interrupted as SCS feed was shut down
09/08/2017 10:47	69.68022	17.76267	230.97	JR16006024	O	Left Fjords - in open water on transit South
08/08/2017 09:32	69.67727	18.98764	0	JR16006022	C	In Port - Tromso
07/08/2017 13:38	70.76577	20.00112	192.46	JR16006022	O	
07/08/2017 13:23	70.76578	20.00128	192.47	JR16006021	C	
07/08/2017 12:12	70.76577	20.00132	192.59	JR16006021	O	B1 back to Tromso
07/08/2017 12:11	70.76577	20.0013	192.65	JR16006020	C	B1 - end of science
02/08/2017 17:06	76.36672	16.66602	40.57	JR16006020	O	At B8. Start of N-S transect back towards Tromso.
02/08/2017 17:05	76.36672	16.66601	40.8	JR16006019	C	End of transect. After CTD cast at B8
31/07/2017 09:09	76.5011	30.48608	294.82	JR16006019	O	At B14 - just before glider recover starts
31/07/2017 09:08	76.50161	30.49204	293.52	JR16006018	C	End of trawling at B14
28/07/2017 11:02	80.10439	29.94858	302.87	JR16006018	O	Started on arrival at B16 - just before CTD cast
28/07/2017 11:01	80.10561	29.93682	306.68	JR16006017	C	Arrival at B16 (stopped before CTD)
25/07/2017 18:24	81.39881	29.68028	294.29	JR16006017	O	At B17
25/07/2017 18:23	81.39881	29.81363	294.27	JR16006016	C	In B17 area - trawling finished
24/07/2017 16:44	81.27596	29.25323	334.94	JR16006016	O	B17 JR 500m BottomTrack 8mBins NOT ThruSSU.txt
24/07/2017 16:43	81.27582	29.25444	334.39	JR16006015	C	Closed to check data with new nav. feed
24/07/2017 14:45	81.28008	29.32716	339.98	JR16006015	O	At B17 With new NMEA feed. No longer from Seapath JR 500m BottomTrack 8mBins NOT ThruSSU.txt
24/07/2017 10:39	81.32809	29.18955	301.56	JR16006010	C	At station B17
23/07/2017 17:41	80.59949	28.3114	213.5	JR16006010	O	No Seapath Nav stream ** Started at approx. B16 Lat : 80 03.9052 N Lon : 30 03.3306
23/07/2017 11:00	81.39881	29.68028	294.29	JR16006008	C	Stopped at B16 just before trawling finished. Seapath navigation stream failed at

						approx. 10:53 Lat : 80 03.9052 N Lon : 30 03.3306 Approx. 274 m Awaiting Seapath fix before starting next file.
20/07/2017 10:44	78.27078	29.97066	322.15	JR16006008	O	Started at the end of B15 - transit to B17
20/07/2017 10:43	78.27079	29.9707	322.23	JR16006007	C	Stopped at end of B15 occupation
18/07/2017 15:58	78.22255	30.93359	242.85	JR16006007	O	Started approx. 10 nm off B15
18/07/2017 15:57	78.22209	30.93975	244.99	JR16006006	C	
14/07/2017 08:50	76.36612	21.00185	227.46	JR16006006	O	Started at B11 JR 500m BottomTrack 8mBins NOT ThruSSU.txt
14/07/2017 08:49	76.36612	21.00188	227.35	JR16006005	C	Stopped at station B11
11/07/2017 15:02	76.03984	16.80936	322.5	JR16006005	O	Cross-shelf transect JR 800m WaterTrack 16mBins NotThruSSU.txt
11/07/2017 15:00	76.04572	16.80769	323.58	JR16006004	C	
10/07/2017 06:52	74.89128	17.79121	257.61	JR16006004	O	No change
10/07/2017 06:51	74.88835	17.79371	262.92	JR16006003	C	
07/07/2017 05:32	69.73596	17.54857	388.6	JR16006003	O	No change in config. from JR16006003 Leaving Tromso
07/07/2017 05:31	78.27078	29.97066	322.15	JR16006002	C	At Tromso
04/07/2017 08:09	62.58111	4.16853	186.17	JR16006002	O	No settings changed from previous file
04/07/2017 08:08	62.57882	4.16848	185.79	JR16006001	C	
02/07/2017 07:13	76.03984	16.80936	322.5	JR16006001	O	JR 500m BottomTrack 8mBins NOT ThruSSU.txt

** No Seapath navigation input so COM4 19200 No Parity un-ticked to disable navigation stream

Temporary new setup for file 10 (VmDas receiving no navigation information from external source)

Transform Tab: Heading source - ADCP compass/gyro

Tilt source - ADCP tilt sensor/gyro

65 x 8 m bins, 8 m blank

0 m transducer depth

Heading and tilt sensor - internal

Bottom track on

Setup saved to *JR16006_Internal_Gyro.ini*

Problems: Seapath failure

From 14/07/2017 onwards the Seapath intermittently lost its heading. The heading information printed under the \$PRDID string in files 6 and 7 (recorded between B11 and B15) is therefore periodically missing.

On 23/07/2017 at approx. 10:53 the Seapath completely failed and stopped providing position, heading, pitch and roll to the ADCP (while file 8 was running).

As a workaround new NMEA strings for the navigation feed into the ADCP were created by William Clark and Peter Lens using the Ashtech, Gyro and Furuno. Under the normal configuration the Seapath feeds the VMADP computer with navigation information directly (low latency, high frequency (10Hz) data)

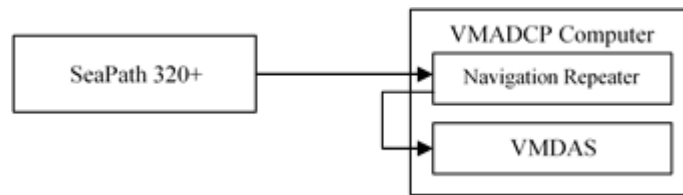

As a replacement alternative navigation sources (Ashtech, Gyro, Furuno) were redirected from the data server via a pre-existing NMEA splitter PC, which rebuilt the required NMEA strings that the VMDAS software could recognize (high latency, low frequency (1Hz) data).

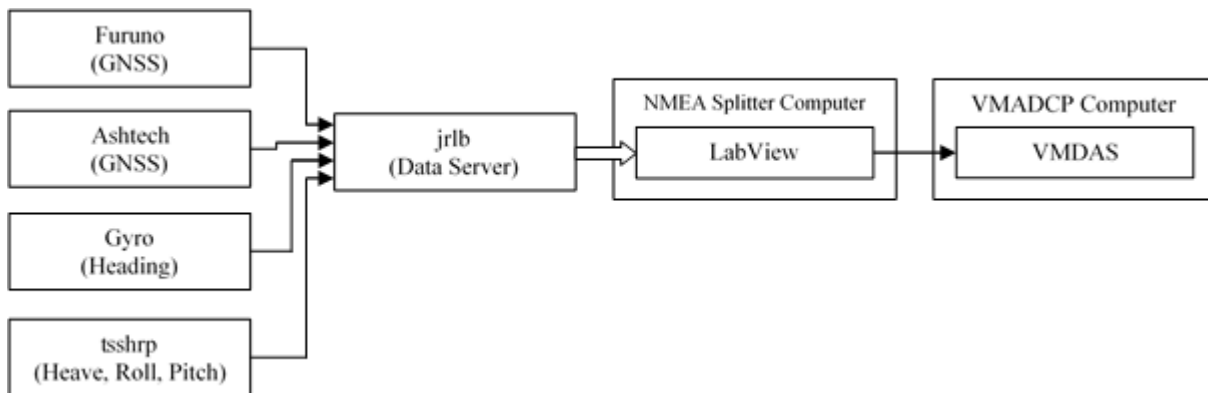

NMEA strings fed to the VMDas software from file 15 onwards were:

\$GPGGA,144534,8116.8043,N,02919.6409,E,1,11,2.0,24,M,23,M,,
Time, Latitude and Longitude from the Ashtech

\$PRDID,0.79,1.36,294.3
Pitch and roll from tsshrp and heading from the Gyro

\$GPVTG,163.0,T,145.0,M,0.6,N,1.1,K,E
True heading, magnetic heading, speed over ground in knots and speed over ground in kph from Furuno.

\$PADCP,1,20170724,144535.95,1.75

Matlab Processing Routines

A suite of Matlab routines was used to perform data screening and transformation into absolute velocities in Earth coordinates. The routines were first obtained from IfM Kiel by Mark Inall and adapted for use on the RRS James Clark Ross by Deb Shoosmith in 2005. Since then numerous bug fixes and refinements have been added by various users: Angelika Renner, Mark Brandon, Hugh Venables and Sam Jones. Minor tweaks were made on this cruise.

The Matlab post processing uses the \$PRDID string in the .N1R files and the binary .ENX file from VMDAS that contains single ping, bin mapped, earth coordinate data (transformed within the software using the heading and tilt sources specified). A detailed description of all the routines can be found in the JR030 cruise report.

In short, the following processing takes place:

1. RDI binary file with extension .ENX (single-ping ADCP ship referenced data from VMDAS) and ascii file with extension .N1R (ascii NMEA output from Seapath saved by VMDAS) are read into the MATLAB environment. NB: The N1R file consists of ADCP single ping time stamps (\$PADCP string) and pitch, roll and heading information (\$PRDID string) from the Seapath.
2. Ensembles with no ADCP data are removed
3. Ensembles with bad or missing heading data identified and adjusted GYRO heading substituted
4. Attitude information time merged with single ping ADCP data
5. Heading data used to rotate single ping ADCP velocities from vessel centreline reference to True North reference
6. Transducer mis-alignment error corrected for (derived from the mis-alignment determination)
7. Ship velocity derived from SeaTex positional information
8. Further data screening performed to remove data where:
 - The correlation in any bin is below 128 (i.e. more noise than signal)
 - There is more than 1 bad beam in the bin
 - The percentage good 4 beam solution = 0
 - Max heading change between pings > 10 degrees per ping
 - Max ship velocity change between pings > $0.5514 \text{ ms}^{-1} \text{ pingrate}^{-1}$
 - Error velocity greater than twice STD of error velocities of single ping profile
9. All data averaged into 300-second super-ensembles
10. Determine absolute water velocities from either bottom track derived ship velocity or SeaTex GPS derived ship velocity, dependent on depth.

Table 2.5.2. Record of misalignment angles and amplitudes calculated for bottom tracking files when the Seapath was operational

Files	Description	Before calibration		After calibration		Note
		Median angle	Median amplitude	Median angle	Median amplitude	
1-2	Soton to Tromso	-0.8531	1.005986	-0.0716	1.000799	Seatex operational
3-4	Northward transect between B1 and B8	-0.9226	1.006743	-0.0641	1.000614	Seatex operational Chosen correction for all files recorded when Seatex operational
18-20	B14-B1	1.5225	1.007944	0.0053	1.000053	New navigation feed Noisy data with high std around mean angle and mean amplitude corrections (2.56 degrees and 0.011 respectively)

The values used in the final processing for files 1-5 (with Seapath) are:

Misalignment = -0.9226

Amplitude = 1.006743

The values used in the final processing for files 15-20 (without Seapath) are:

Misalignment = 1.5225

Amplitude = 1.007944

Intermittent loss of the Seapath navigation data meant that .N1R and .ENX files 6 and 7 (between B11 and B15) could not be read by the Matlab processing software. As a workaround, the .LTA files created by VmDas (10 minute averages) were exported using the RDI WinRiver software. A 10 min average for file 10 (no navigation stream) was also extracted using WinRiver

Table 2.5.3. Output files

VMADCP Files	Description	Output file name
1-2	Southampton to Tromso	JR16006_files_1_to_2.mat
3-4	Northward transect between B1 and B8	JR16006_files_3_to_4.mat
5	Off shelf transect B10-B11	JR16006_files_5_to_5.mat
6-7	B11-B15 (Intermittent Seapath heading drop outs)	WinRiver_LTA_export_6.mat WinRiver_LTA_export_7.mat
8	B15-B16 (Seapath failure)	WinRiver_LTA_export_8.mat
10	B16-B17	WinRiver_LTA_export_10.mat
15-18	B17-B18-B14 (New navigation feed)	JR16006_files_15_to_18.mat
19-20	B14-B1 (end of science, new navigation feed)	JR16006_files_19_to_20.mat

Further quality control and checks will take place before final data sets are produced.

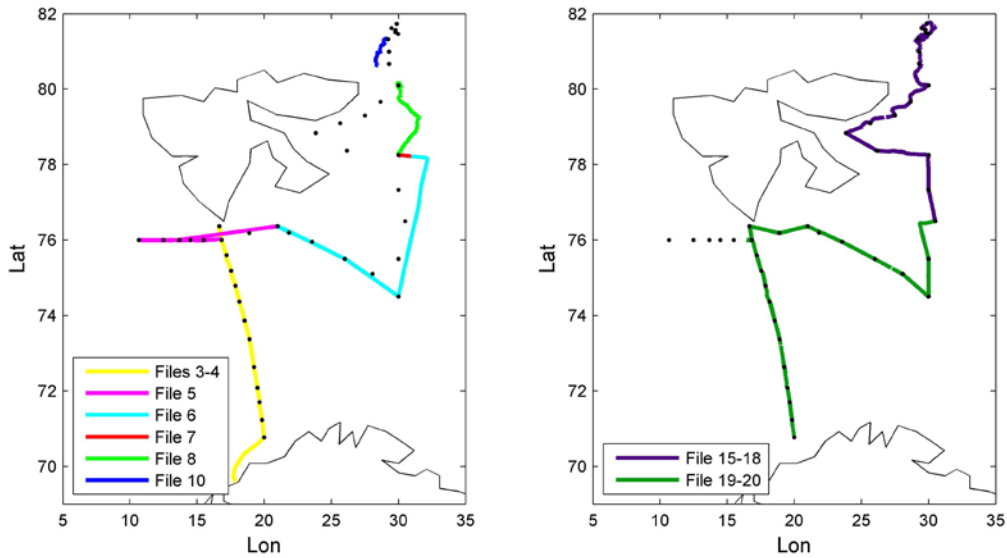

Figure 2.5.1. Map showing where each VMADCP file was recorded

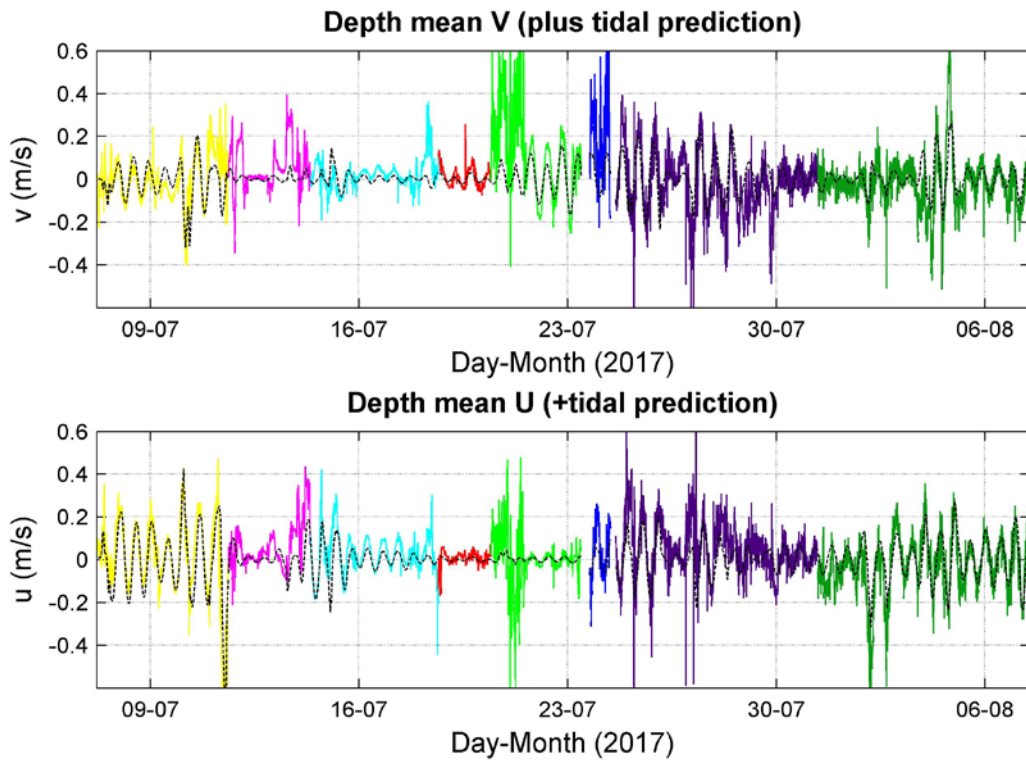

Figure 2.5.2. Depth mean velocities plus a tidal prediction (dashed back line) from OSU Tidal Inversion Software (Egbert, Gary D., and Svetlana Y. Erofeeva. "Efficient inverse modeling of barotropic ocean tides." *Journal of Atmospheric and Oceanic Technology* 19.2 (2002): 183-204). Legend as in Figure 2.5.1.

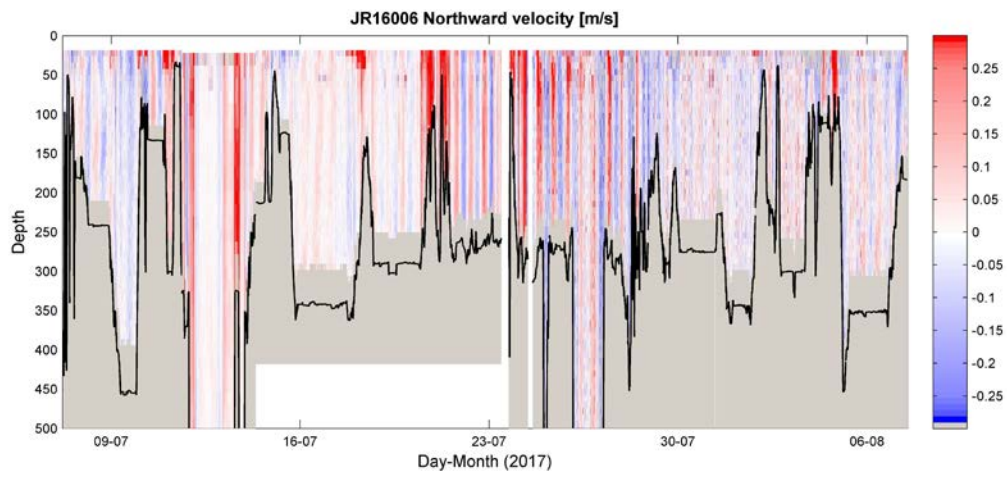

Figure 2.5.3. Full north-south (v) velocity profiles

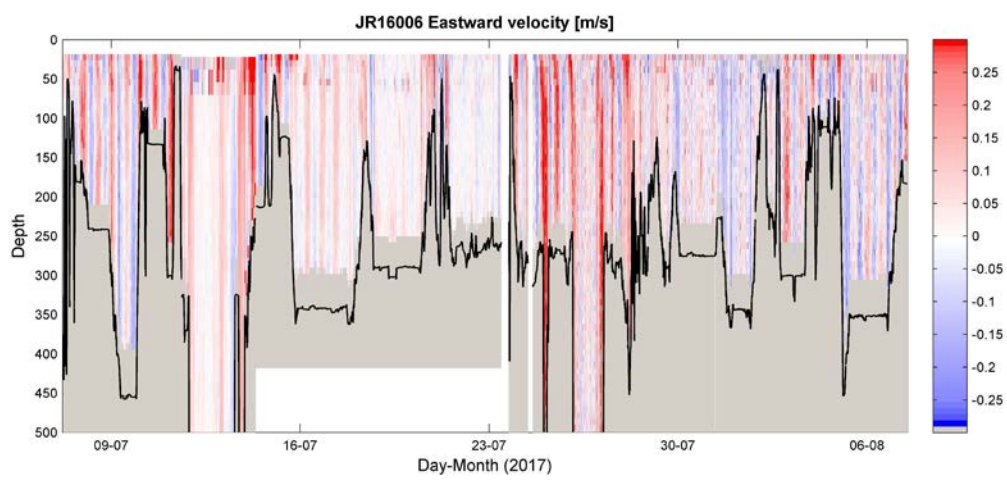

Figure 2.5.4. Full east-west (u) velocity profiles

3. Glider deployment

^{1,2}Marie Porter (SAMS), ¹Estelle Dumont (SAMS), ¹Emily Venables (SAMS)

¹Author, ² Dataset PI

Arctic PRIZE

Background and objectives

Glider activity in the Barents Sea has historically been very low with only one previous deployment known to the authors. Thus this deployment was both for science and for collected information with which to advise future glider deployments in this region. The glider flew between station B13 and station B14, approximately staying on the 30° meridian.

Station B13 is an area that has been free of ice for a number of months and therefore represents an area of open water. In contrast B14 was covered in ice within the month previous to the glider occupation and therefore represents the seasonal ice zone. Consequently this glider mission provides a high resolution transect between these two hydrologically and ecologically distinct zones.

Instrument specifications

Model	Slocum G2 Shallow
Manufacturer	Webb Teledyne
Serial number	unit_306
Name	Zephyr
Owner	NERC Marine Autonomous & Robotic Systems (MARS)
Depth rating	200m
Sensors	Seabird pumped CT sail S/N 9099 Wetlabs puck (chl-a, CDOM, red backscatter) S/N 3288 Aanderaa oxygen optode S/N 230 PAR S/N 430
Battery type	Slocum Lithium Steatite
Positioning	GPS
Communications	Iridium, FreeWave
Emergency communications & positioning	Argos tag
Other devices	Altimeter, strobe

Mission specifications

Deployment date	17/07/2017 14:55:00 UTC
Deployment location	74.46672 N, 30.00044 E
Cruise event number	138
Recovery date	31/07/2017 14:28:00 UTC
Recovery location	76.46713 N, 29.32702 E
Cruise event number	328

Operations & sampling strategy

Prior to the cruise the glider “Zephyr” was refurbished and ballasted by MARS (Marine Autonomous & Robotics Systems group). Onboard the ship a portable pool was filled with in-situ surface water and the ballasting checked and adjusted slightly. A full functional check was carried out prior to deployment, which proved satisfactory.

The glider was lifted in two strops (looped around the body of the glider and secured by wooden pegs) over the side using the starboard crane, and released when it reached the water by pulling on the two wooden pegs. Poles were used to push the glider away from the hull while the ship

maneuvered forward. Piloting was then handed over to the MARS group at NOC for the following two weeks.

“Zephyr” was deployed at B13 and spent two weeks transiting to B14. The short duration of this deployment meant no restrictions on the battery usage for science sampling. As such we collected CTD, dissolved oxygen, fluorescence, CDOM, backscatter and PAR throughout the top 200m of the water column. Using dead reckoning the glider is also able to estimate the depth average velocity at the location of each of its dives.

At the end of its mission “Zephyr” was recovered in a custom-made net (consisting of a cargo net and poles on all four sides) lowered by strops using the starboard crane. The glider was “scooped out” of the water very smoothly and without damage. The subsampled data files (*.sbd and *.dbd) were downloaded over the Freewave onboard the ship. The full dataset will be recovered from the CF card once the glider returns to MARS.

Methods

The subsampled data files (.sbd and .tbd) have been processed using the Slocum glider executables:

```
rename_dbd_files  
dbd_2_asc  
dba_merge  
dba2_orig_matlab
```

Data quality notes/ problems

The data presented here are the raw data and have not yet been processed to correct for the thermal lag errors known to exist within glider data, particularly in well stratified regions. Similarly the data have not been corrected to the CTD data collected prior to and at the end of the deployment.

Results

The glider successfully followed a north-south line between stations B13 and B14, largely staying on the meridian. At the northern end of the transect the glider was subject to stronger currents which displaced it slightly westward (Figure 3.1).

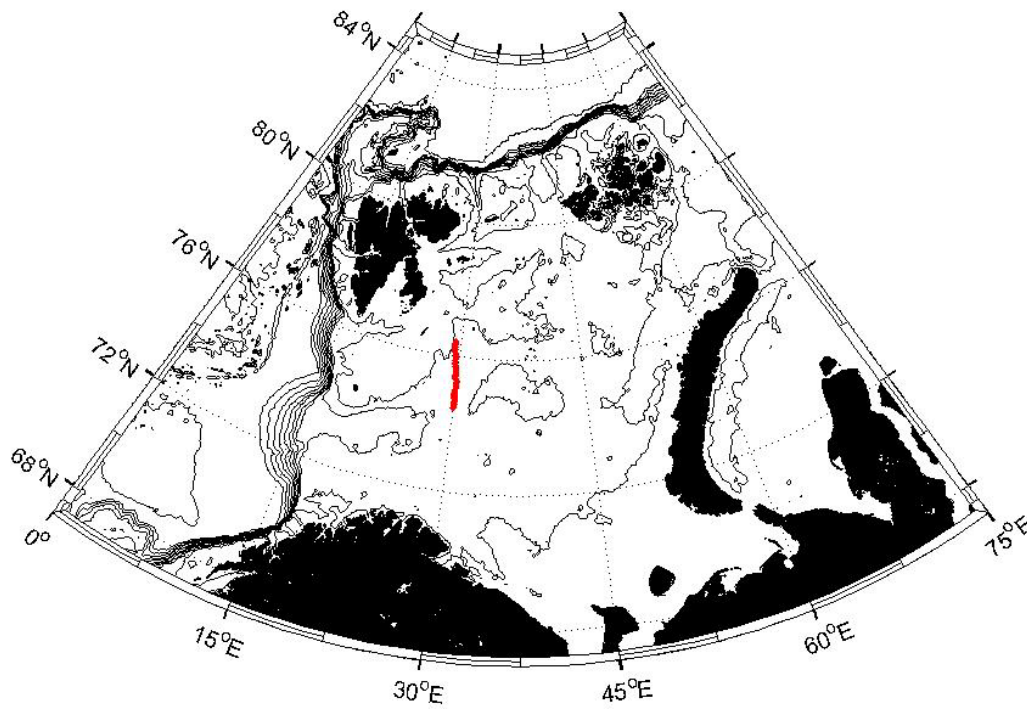

Figure 3.1: The glider track is shown in red

As the glider tracked north of 75°N it may have passed through the region of the polar front, with a reduction in both temperature (Figure 3.2) and salinity (Figure 3.3). North of the possible polar front region there is a strong halocline which appears to be tied to the chlorophyll maximum (Figure 3.4).

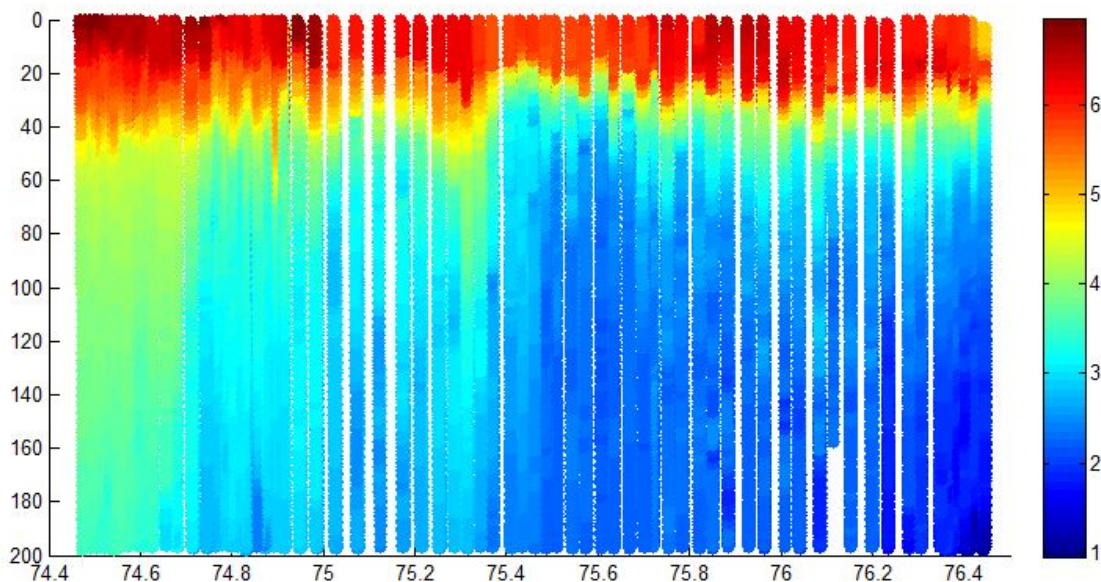

Figure 3.2: The potential temperature along the approximate meridian from south to north.

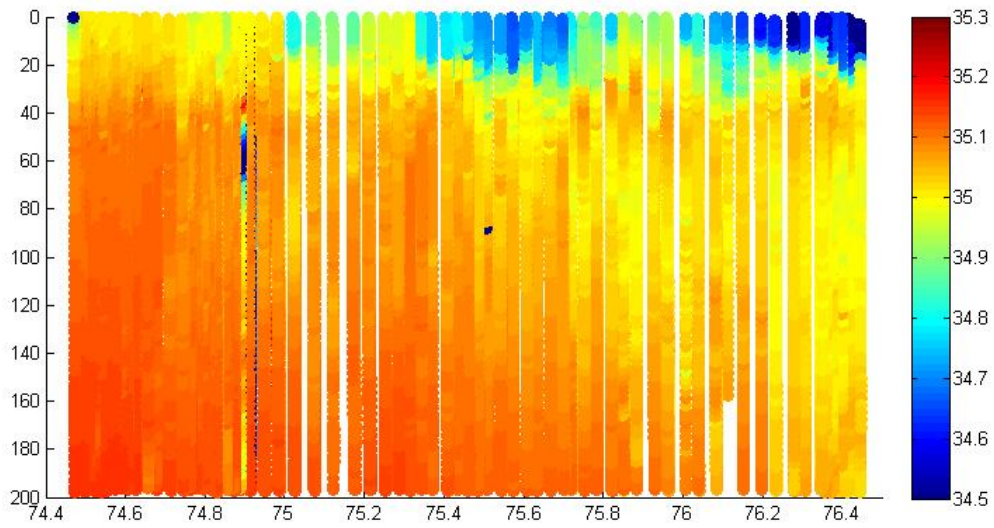

Figure 3.3: The salinity (in psu) along the approximate meridian from south to north.

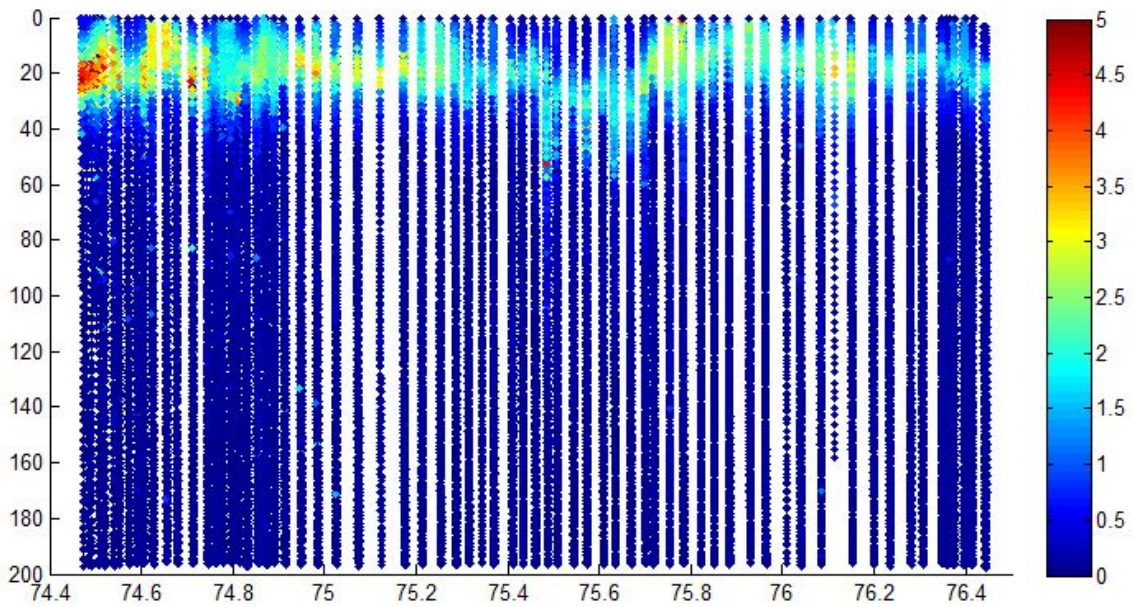

Figure 3.4: The fluorescence along the approximate meridian from south to north.

4. Oxygen

^{1,2}Tim Brand (SAMS), ¹Estelle Dumont (SAMS)

¹Author, ² Data set PI

Background and objectives

A selected number of Winkler titration samples collected using the CTD rosette were used for calibration purposes of the Seabird™ polarographic dissolved oxygen probes which formed part of the CTD instrument package.

Methods

Samples were collected in 110ml glass bottles with gas tight ground glass lids and volume calibrated to 3dp. Water samples were collected using a length of silicon rubber tube connected to the CTD bottle spigot and which was allowed the sample to gently overflow from the bottle for approximately 15-20 seconds to ensure no air was contained within the bottle and that the bottle had attained the same temperature as the water. Care was also taken to ensure that no bubbles remained in the length of rubber tubing during this filling process. Once the bottle had been filled and the glass bottle allowed to equilibrate with the water temperature, 1ml each of Winkler solutions A and B (manganese chloride tetra chloride and a sodium hydroxide-sodium iodide mix) were carefully injected into the sample and the glass ground lid replaced. Care was also taken to ensure that no air bubbles were trapped under the lid during the capping process. The sample was then inverting 3 times. The samples were then allowed to sit for between 2 and 6 hours at room temperature before analysis.

Analysis was performed by initially dissolving the manganous (III) oxyhydroxide precipitate with sufficient sulphuric acid which allowed the iodide to convert to iodine. The iodine was titrated with a sodium thiosulphate solution of known concentration using spectrophotometry to identify the end-point of the titration. The titration apparatus was a Radiometer Copenhagen Autotitrator TM90 with a fabricated spectrophotometer cell for determining the end-point. The sodium thiosulphate titrate was standardised against potassium iodate solution which itself had been standardised against a known potassium iodate solution purchased from OSIL.

Instrument/method problems

It became apparent within the first week of the cruise that the first oxygen probe installed on the CTD instrument package was reading about 60% of the Winkler titration results. Also, the calibration of the probe results collected from the CTD bottle firing files with the Winkler titration results showed as less than ideal correlation coefficient. A second probe was installed which recorded alongside the 1st probe and provided data more closely matching those of the Winkler titrations and showed a much-improved calibration over the first probe.

Part way through the cruise a batch of 5M a second batch of 5molar sulphuric was used for the acidification step prior to the titration. This proved to have insufficient molarity for the purpose of fully dissolving the manganous oxyhydroxide that is produced on combination of the two Winkler solutions. It was evident from the poor reproducibility of the triplicates that incomplete dissolution of the precipitate was occurring. To remedy this and since a larger volume than 1ml of 5M sulphuric acid normally added would not have been possible, the acid addition was changed to 0.5ml of concentrated (18M) sulphuric. This provided excellent reproducibility in the titration results.

Table 4.1 CTD Samples analyzed and Winkler titration results

CTD Cast	Station	Niskin	Depth (m)	Wnkler O2 (uM/l)	O2 Mean (uM/l)	O2 SD (uM/l)	O2 SE (%)	CTD Probe 1	CTD Probe 2
1	B1	1	185	284.45					
1	B1	1	185	285.06					
1	B1	1	185	285.13	284.88	0.37	0.13	194.60	
1	B1	7	50	284.58					
1	B1	7	50	278.99					
1	B1	7	50	282.22	281.93	2.81	1.00	193.59	
2	B2	1	251	292.51					
2	B2	1	251	293.70					
2	B2	1	251	292.38	292.86	0.72	0.25	198.47	
2	B2	15	45	297.00					
2	B2	15	45	299.87					
2	B2	15	45	298.15	298.34	1.44	0.48	201.97	
3	B4	1	456	306.80					
3	B4	1	456	306.66					
3	B4	1	456	305.49	306.31	0.72	0.24	211.70	
3	B4	6	199	304.54					
3	B4	6	199	303.96					
3	B4	6	199	304.43	304.31	0.31	0.10	208.61	
4	B6	1	133	326.59					
4	B6	1	133	325.45					
4	B6	1	133	327.47	326.50	1.01	0.31	226.74	
4	B6	8	25	357.55					
4	B6	8	25	356.49					
4	B6	8	25	356.57	356.87	0.59	0.16	245.04	
9	B10	1	2209	295.17					
9	B10	1	2209	298.93					
9	B10	1	2209	294.35					
9	B10	1	2209	297.21					
9	B10	1	2209	299.95	297.12	2.39	0.80	220.99	
9	B10	6	1004	314.08					
9	B10	6	1004	312.52					
9	B10	6	1004	317.68	314.76	2.65	0.84	226.75	

9	B10	16	105	309.02					
9	B10	16	105	309.20					
9	B10	16	105	309.80	309.34	0.41	0.13	213.91	
14	B11	1	223	315.21					
14	B11	1	223	315.15					
14	B11	1	223	313.60	314.65	0.91	0.29	220.35	292.47
14	B11	9	81	311.22					
14	B11	9	81	311.56					
14	B11	9	81	310.61	311.13	0.48	0.16		
16	B12	1	130	poor data					
16	B12	1	130	poor data					
16	B12	1	130	321.53	321.53			229.09	303.87
16	B12	11	31	poor data					
16	B12	11	31	poor data					
16	B12	11	31	poor data	no data	no data	no data	250.74	335.35
17	B13	1	343	poor data					
17	B13	1	343	319.87					
17	B13	1	343	319.07	319.47	0.57	0.18	223.39	294.57
17	B13	10	70	poor data					
17	B13	10	70	311.82					
17	B13	10	70	poor data	311.82			215.14	287.99
19	B15	1	320	poor data					
19	B15	1	320	338.04					
19	B15	1	320	poor data	338.04			241.70	315.02
19	B15	9	174	313.90					
19	B15	9	174	poor data					
19	B15	9	174	309.80	311.85	2.90	0.93	218.23	287.51
19	B15	12	70	poor data					
19	B15	12	70	poor data					
19	B15	12	70	poor data				244.90	321.57
27	B18	2	2760	304.65					
27	B18	2	2760	302.63					
27	B18	2	2760	301.04	302.77	1.81	0.60	226.27	275.09
27	B18	8	1202	305.89					

27	B18	8	1202	305.06					
27	B18	8	1202	305.56	305.50	0.42	0.14	221.57	280.60
27	B18	16	154	307.54					
27	B18	16	154	308.02					
27	B18	16	154	304.66	306.74	1.82	0.59	214.61	284.26
30	B16	3	278	344.81					
30	B16	3	278	344.69					
30	B16	3	278	344.23	344.58	0.31	0.09	244.42	319.40
30	B16	15	50	346.17					
30	B16	15	50	346.58					
30	B16	15	50	346.52	346.42	0.22	0.06	245.71	323.08
48	B7	1	308	311.32					
48	B7	1	308	310.68					
48	B7	1	308	311.21					
48	B7	1	308	310.95					
48	B7	1	308	311.10	311.05	0.25	0.08	216.46	285.69
48	B7	9	140	294.24					
48	B7	9	140	294.06					
48	B7	9	140	294.53					
48	B7	9	140	294.47					
48	B7	9	140	294.79	294.42	0.28	0.10	202.73	270.69

Calibration of the two Seabird oxygen probes is shown in Figure 1 below. Calibration results:

Probe 1: Gradient 0.720, intercept -5.770, Cor. coef. 0.8295

Probe 2: Gradient 1.012, intercept -27.813, Cor. Coef 0.9856

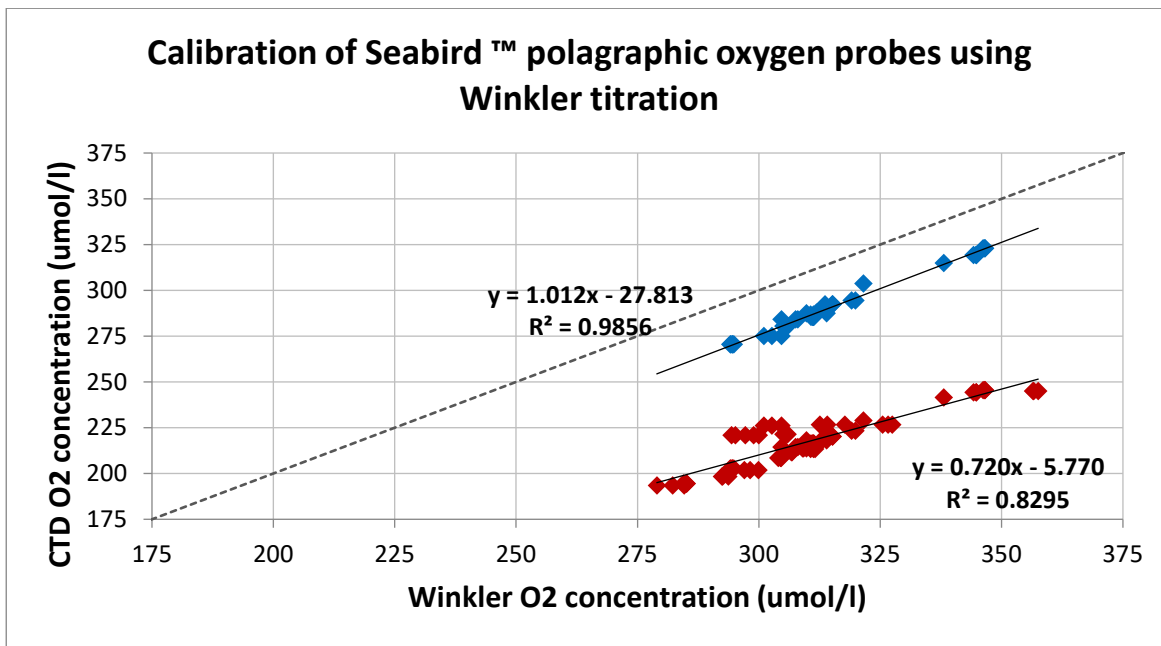

Figure 4.1: Calibration of Seabird oxygen probes. Probe 1 in red, Probe 2 in blue.

5. Water column biogeochemistry

5.1 Nutrients and isotopes

¹Louisa Norman, ^{1,2} Camille de la Vega, ² Claire Mahaffey (University of Liverpool), ^{1,2} Sian Henley and ¹Celeste Kellock (University of Edinburgh)

¹ Authors, ² Data set PIs

ARISE, Arctic PRIZE and ChAOS

Background and Objectives

Samples were taken for analysis of the concentration and isotopic composition of macronutrients and particulate organic matter at a total of 24 stations along the ship track from Tromsø through the Barents Sea to beyond the shelf break of the Nansen Basin. The overarching objective was to examine the supply, uptake and cycling of nitrogen, phosphorus, silicon and carbon throughout the water column of the Barents Sea, as well as their benthic-pelagic exchange and export fluxes. The specific aim of the ARISE project was to target key water masses and gateways for delivery and export of N and C in the Barents Sea via a series of transects, starting in the fresh coastal current, crossing the Polar Front, then the shelf edge and finally, continuing northwards into the marginal ice zone and towards the pack ice as conditions allowed. Thus, producing a dataset which represents the water masses present (i.e. Atlantic and Arctic waters) and their end members. These measurements will be paired with food web tracer measurements of ¹⁵N, ¹³C and ¹⁵N amino acids (¹⁵N-AA) from POM (see below and section on zooplankton for rationale) and zooplankton (see section on zooplankton) which will be used to set a spatial and seasonal baseline for the isoscape in this region. The specific aim of the ChAOS project was to describe the water column nutrient chemistry overlying the six benthic stations (B13-B17 and B3) in order to pair with our benthic measurements (see section on sediment and porewater geochemistry) to improve our understanding of benthic-pelagic coupling and quantify nutrient fluxes from the water column to the benthos and from sediments and porewaters to the water column across the sediment-water interface. Samples were also taken along a transect south west of Svalbard to characterise the flow of Atlantic water into the Barents Sea and quantify the supply of Atlantic-derived nutrients as part of the Arctic PRIZE project.

CTD sampling and methods

Samples were taken from the CTD rosette for $\delta^{15}\text{N}$ and $\delta^{18}\text{O}$ isotopes of nitrate, $\delta^{15}\text{N}$ of ammonium and dissolved organic nitrogen, $\delta^{30}\text{Si}$ of silicic acid, and the concentration and $\delta^{13}\text{C}$ of dissolved inorganic carbon. In addition, samples for particulate biogenic silica (PBS) were taken from the ships underway system at 19 stations. These samples were taken alongside samples measured onboard for macronutrient concentrations (nitrate, nitrite, ammonium, phosphate, silicic acid). Samples for $\delta^{15}\text{N}\text{-NO}_3$, $\delta^{15}\text{N}\text{-NH}_4$, $\delta^{15}\text{N}\text{-DON}$ were taken by the ARISE team at pelagic stations B1-B12, B18. Samples for [DIC], $\delta^{13}\text{C}\text{-DIC}$ and $\delta^{30}\text{Si}$ were taken at stations B7-B10 and B18. At the benthic stations B13-B17, samples for nitrate and silicic acid isotopes were taken by the ChAOS team, whilst samples for $\delta^{15}\text{N}\text{-NH}_4$, $\delta^{15}\text{-DON}$, [DIC] and $\delta^{13}\text{C}\text{-DIC}$ (stations B15-B17) were taken by the ARISE team. Sampling of $\delta^{15}\text{N}\text{-NO}_3$, $\delta^{15}\text{N}\text{-NH}_4$, and $\delta^{15}\text{-DON}$ for the additional stations B19-B22, B32 and B34-38, which were added during the cruise, was shared between the ARISE and ChAOS/Arctic PRIZE teams. All data will be shared in the same way as the sampling to maximise the science output of the cruise.

N and Si isotopes (ChAOS/Arctic PRIZE)

Samples for analysis of the isotopic composition of nitrate and silicic acid were taken from the CTD rosette immediately after sampling for nutrient concentrations and stored in the dark at $<+4$ °C until

processing within four hours. Samples were hand-filtered using acid-cleaned and thoroughly mQ.H₂O-rinsed Plastipak syringes and sterile supor 0.2 µm pore size acrodisc filters into acid-clean and mQ.H₂O-rinsed HDPE bottles for storage. All apparatus were pre-rinsed thoroughly with sample and a clean syringe and new filter were used for each sample. Nitrate isotope samples were flash-frozen at -80 °C for <24 hours and then stored at -20 °C for subsequent analysis at the University of Edinburgh. Silicic acid samples were stored at +4 °C in the dark for subsequent analysis at the University of Bristol. Nutrient concentrations were measured on a duplicate set of filtered samples to compare with nutrient data from unfiltered samples, as was standard for the cruise.

N and Si Isotopes (ARISE)

Full profiles were taken at 22 stations (see sampling strategy section and table 5.1.2). N isotope samples were taken from the Niskin bottles into acid cleaned carboys after gas and nutrient samples. Carboys were rinsed three times with the appropriate water before collecting the sample. Samples were filtered within 2 hrs of collection through pre-combusted 47mm GF/F filters using a glass filtration rig. The glassware and acid-cleaned sample bottles were rinsed with sample prior to collection of $\delta^{15}\text{N-DON}$, $\delta^{15}\text{N-NO}_3$ and $\delta^{15}\text{N-NH}_4$ and the filter was changed for each new sample. $\delta^{15}\text{N-DON}$ and $\delta^{15}\text{N-NO}_3$ samples were closed with a screw cap, placed in two zip lock bags, labelled and stored in a -20 freezer. $\delta^{15}\text{NH}_4$ samples were acidified to pH 2-3 in a fume hood with 6M trace-metal clean HCl before being placed in two ziplock bags, labelled and stored in a -20°C freezer.

Full Si isotope profiles were taken at eight stations (See sampling strategy section). Si isotope samples were taken directly from the Niskin bottles into the sample bottles using an Acropak 500 0.4 micron capsule filter attached to the Niskin using acid-cleaned tygon tubing. Water from the Niskin was allowed to flow through the tubing and Acropak capsule to rinse prior to rinsing (x3) and filling of the sample bottles. Samples were taken to the lab and acidified to pH 2-3 using 6M trace-metal clean HCl in the fume hood. The samples were sealed with screw caps, parafilm, placed in two ziplock bags and labelled. All samples were stored in the dark (black bag and in a closed crate) at ambient laboratory temperature.

DIC and $\delta^{13}\text{C-DIC}$

Full profiles were taken at eight stations (see sampling strategy section). Samples for the analysis of $\delta^{13}\text{C-DIC}$ and [DIC] were taken directly after the oxygen samples. Using acid clean tubing, water was taken from the Niskin bottle directly into 250 mL borosilicate glass reagent bottles and 30 mL amber soda-lime glass bottles for DIC and $\delta^{13}\text{C-DIC}$, respectively. The DIC bottles were allowed to overflow one full volume and the $\delta^{13}\text{C-DIC}$ bottles two volumes to rinse. DIC and $\delta^{13}\text{C-DIC}$ samples were placed in a fume hood and a volume of 6 mL (DIC) or 60 µL ($\delta^{13}\text{C-DIC}$) was removed to provide headspace. Samples were then preserved with saturated HgCl₂ using 100 µL for the DIC samples and 30 µL for the $\delta^{13}\text{C-DIC}$ samples. The DIC samples were then sealed with an Apiezon L greased glass stopper, secured with electrical tape and inverted three times to mix. The 30 mL $\delta^{13}\text{C-DIC}$ bottles were sealed with screw caps and parafilm. Samples were stored at 4°C and will be stored at a stable temperature prior to analysis at the University of Edinburgh.

Particulate Biogenic Silica

Whilst on station, water was collected for the determination of particulate biogenic silica from the ship underway system using acid clean carboys. Time of sample was taken and the co-ordinates recorded. Four to 6 L of water was filtered through a 47 mm polycarbonate filter (0.8 µm) using an acid-cleaned polycarbonate filtration unit. Filters were then folded in half, wrapped in combusted foil, and placed in a labelled ziplock bag. Samples were stored at -20°C.

All ARISE samples detailed above will be returned to the home laboratory (University of Edinburgh) for analysis.

Particulate organic matter (POM)

Samples for $\delta^{15}\text{N}$ and $\delta^{13}\text{C}$ POM were taken from the CTD rosette at depths corresponding to the above described dissolved isotope samples. At stations deeper than 300 m six to eight depths were sampled together with two or three depths between 300 m and the bottom. Full profiles were taken at stations > 300 m (Table 5.1.3). Samples were collected from the Niskin bottles in acid-clean 5 L carboys pre-rinsed with seawater from the underway system. After collection, the samples were placed in the dark and taken to the laboratory for filtering. The seawater was filtered through a 25 mm GF/F filter until a good colour was evident at which point the filtration was stopped and the volume of water filtered recorded. The filters were placed in combusted foil-lined petri dishes and placed in a -80°C freezer for 24 hrs prior to storage at -20°C .

SAPs sampling and methods

In addition to the sampling for $\delta^{15}\text{N}$ and ^{13}C of POM from the CTD rosette, samples for ^{15}N -AA in POM were taken using four in-situ stand-alone pumps (SAPs) at pelagic stations B1-B12 and B18, and benthic stations B13-B17. The four depths were selected to correspond with the CTD POM sampling at depths between the surface and 300 m.

SAPs were mostly deployed from the forward crane using the MacArtney winch on the starboard side. Once, when ice cover was too heavy, the mid ships gantry was used instead to allow the ship to better shelter the wire from ice flows.

Each SAP was deployed with a SBE39 attached so as to prove to depth of deployment. Pump times for all casts were set for one hour of pumping. Several times there were electrical issues with the MacArtney winch "losing sync". This was resolved by the ETO and deck engineer and required re-setting the start sequence of the SAPs. This had no notable impact on the deployment.

The first deployment proved that the wire counter on the winch was out by approximately 10%. As such, 10% extra wire was paid out for each SAP depth. This proved to work very well with most target depths being hit within several metres.

SAPs Mindi and Bambi were on their maiden deployments as they were new units. As such there were a few issues with them not pumping on some deployments. This has been attributed to the impellor not staying magnetically coupled to the motor. Investigation found the resistance of the new impellors against the titanium window to be higher than that on the older models so some fine tuning was done to the impellor bushes and thrust washers. This seems to have resolved the issue.

During the cruise SAP Sn13, Wendy, was built and deployed for test purposes only. The pressure housing was proven to 250m and the new electronics board designed and built by John worked successfully.

SAP and SBE39 serial numbers:

- SAP Sn 03-06 Molly with SBE39 Sn 1650
- SAP Sn 03-04 Holly with SBE39 Sn 1651
- SAP Sn 11 Mindi with SBE39 Sn 1652
- SAP Sn 12 Bambi with SBE39 Sn 1653

In total there were 18 deployments of SAPs. The following tables detail the depths and volumes pumped of each unit.

	Depth	Litres pumped	Comments
Mindi			
08/07/2017	195	1287	
09/07/2017	14	287	
10/07/2017	101	0	Suspect new impellor issue
11/07/2017	10	179	Flow counter run backwards?
12/07/2017	239	174	
13/07/2017	245	0	Did pump, flow counter stuck
14/07/2017	178	736	
15/07/2017	67	433	
16/07/2017	71	463	
19/07/2017	174	1	Flow counter seised
22/07/2017	195	801	
25/07/2017	117	768	
26/07/2017	272	0	Suspect new impellor issue
30/07/2017	266	841	
03/08/2017	243	760	
04/08/2017	43	550	
05/08/2017	42	722	
07/08/2017	136	986	
Total		8988	

	Depth	Litres pumped	Comments
Bambi			
08/07/2017	41	417	
09/07/2017	77	2	Suspect new impellor issue
10/07/2017	45	0	Suspect new impellor issue
12/07/2017	35	6	Suspect new impellor issue
13/07/2017	25	451	
14/07/2017	50	788	
15/07/2017	38	496	
16/07/2017	30	443	
19/07/2017	70	564	
22/07/2017	30	386	
25/07/2017	39	702	
26/07/2017	58	746	
30/07/2017	75	8	Suspect new impellor issue
03/08/2017	49	702	
04/08/2017	107	232	

05/08/2017	329	934	
07/08/2017	47	24	Suspect new impellor issue
Total		6901	

	Depth	Litres pumped	Comments
Holly			
08/07/2017	14	191	Gobbled a massive jellyfish
09/07/2017	37	360	
10/07/2017	25	255	
11/07/2017	35	403	
12/07/2017	9	111	
13/07/2017	14	409	
14/07/2017	25	464	
15/07/2017	15	352	
16/07/2017	15	287	
19/07/2017	14	329	
22/07/2017	5	465	
25/07/2017	16	304	
26/07/2017	42	261	
30/07/2017	3	348	
03/08/2017	26	466	
04/08/2017	25	357	
05/08/2017	9	410	
07/08/2017	8	262	
Total		6034	

	Depth	Litres pumped	Comments
Molly			
08/07/2017	8	405	
09/07/2017	287	699	
10/07/2017	6	514	
11/07/2017	18	362	
12/07/2017	14	335	
13/07/2017	8	321	
14/07/2017	14	377	
15/07/2017	9	370	
16/07/2017	4	350	
19/07/2017	32	281	
22/07/2017	14	417	
25/07/2017	3.7	413	
26/07/2017	8	460	
30/07/2017	46	483	
03/08/2017	4	598	

04/08/2017	7	358	
05/08/2017	23	525	
07/08/2017	24	451	
Total		5304	

¹⁵N-AA of Particulate organic matter (POM)

Each SAP filter head was loaded with an acid-cleaned 52 µm nylon mesh circle, to filter larger particles, and a pre-combusted 293 mm GF/F filter. The SAPs were then deployed at selected depths (Table 5.1.3) and set to pump for one hour. Upon recovery, the volume pumped was recorded and the filter heads allowed to drain of water. The 52 µm mesh was rinsed with ultrapure water (milli-q) and the particles collected for further filtration on to a 47 mm pre-combusted GF/F filter. Where samples had a very dense particle loading that would saturate the 47 mm GF/F filter, a proportion of the material rinsed from the mesh was filtered and the volume recorded. The 47 mm filters were placed in combusted foil-lined petri dishes and placed in a -80°C freezer for 24 hrs prior to storage at -20°C. The 293 mm filters were removed from the filter head, folded in four, wrapped in pre-combusted foil, bagged and placed in a -80°C freezer for 24 hrs prior to storage at -20°C.

Both the POM sampled from the CTD and the ¹⁵N-AA POM from the SAPS will be analysed at the home laboratory (University of Liverpool).

Samples collected

Table 5.1.1. Samples collected for ChAOS and Arctic PRIZE

event	ctd	station	latitude	longitude	bottom	date	depths
52	6	B7a	76 00.01	16 49.95	319	11/07/2017	5, 15, 25, 40, 100, 120, 150, 200, 250, 300, 307
67	10	B19	76 00.01	12 29.99	1715	13/07/2017	10, 20, 40, 60, 100, 250, 400, 600, 800, 1100, 1400, 1673
74	13	B20	76 00.00	14 30.00	320	13/07/2017	5, 15, 25, 40, 60, 90, 125, 160, 190, 220, 250, 270, 311
87	15	B22	76 12.00	21 50.04	103	14/07/2017	5, 15, 25, 35, 45, 50, 60, 85, 95
105	17	B13	74 28.00	30 00.02	355	16/07/2017	5, 15, 30, 40, 70, 105, 175, 245, 324, 344
147	19	B15	78 12.86	30 00.05	330	19/07/2017	0.5, 15, 26, 34, 40, 70, 110, 175, 190, 260, 300, 320
186	20	B16	80 09.19	29 55.05	293	22/07/2017	5, 15, 30, 60, 120, 200, 268, 278
235	23	B17	81 24.12	29 31.00	293	25/07/2017	5, 17, 25, 40, 70, 120, 150, 180, 271, 281
296	38	B14	76 29.96	30 17.22	290	30/07/2017	3, 22, 40, 48, 75, 120, 180, 200, 269, 279
374	55	B3	72 37.99	19 15.01	366	05/08/2017	340, 345, 350, 355, 360

Table 5.2.2. N isotope, Si isotope, [DIC], $\delta^{13}\text{C}$ -DIC, and ^{15}N and ^{13}C POM samples collected for ARISE. The depths highlighted in red indicate where the the Niskin bottle did not fire and the sample was not collected. * = No POM collected. ** = Full d15N-NO3 profile taken by ChAOS team.

EVENT	CTD	STATION	LATITUDE	LONGITUDE	BOTTOM (m)	DATE	DEPTHS (m)
411	59	1	70°45.000	19°59.871	190	07/08/2017	10, 27, 50, 80, 140, 182
6	2	2	71°41.997	19°39.961	256	08/07/2017	10, 25, 45, 80, 120, 150, 200, 250
374	55	3	72°37.985	19°15.012	366	05/08/2017	10, 25, 40, 70, 160, 280, 340, 360
18	3	4	73°22.069	18°55.081	470	09/07/2017	10, 37, 50, 75, 100, 150, 300, 460*
365	52	5	74°21.989	18°09.979	119	04/08/2017	8, 25, 38, 50, 75, 108
32	4	6	75°10.994	17°32.003	141	10/07/2017	8, 20, 45, 60, 100, 130
357	48	7	76°00.009	16°50.012	319	03/08/2017	6, 28, 50, 100, 140, 200, 250, 309
47	5	8	76°21.986	16°39.930	45	11/07/2017	5, 10, 18, 25, 30, 35, 41
68	11	9	75°59.999	13°40.013	1028	13/07/2017	10, 15, 25, 50, 75, 150, 250, 400*, 525, 700*, 900, 1017*
57	9	10	76°00.000	10°40.000	2259	12/07/2017	10, 15, 35, 50, 100, 250, 375, 500, 600*, 750, 1000*, 1250*, 1500, 1750*, 2249*
78	14	11	76°22.000	21°00.110	231	14/07/2017	3, 15, 27, 50, 80, 120, 180, 210, 222
90	16	12	75°30.000	26°00.106	134	15/07/2017	10, 15, 25, 30, 37, 53, 62, 129
105	17	13	74°28.000	30°00.015	355	16/07/2017	5, 15, 30, 40, 70, 105, 175, 245, 324, 344*
296	38	14	76°29.965	30°17.225	296	30/07/2017	3, 22, 40, 48, 75, 120, 180, 200, 269, 279
147	19	15	78°12.861	30°00.045	330	19/07/2017	0.5*, 3, 15, 34, 70, 110, 175, 190**
186	20	16	80°09.012	29°54.760	276	22/07/2017	5, 15, 30, 60, 120, 200, 268, 278
235	23	17	81°24.117	29°30.625	290	25/07/2017	5, 17, 25, 40, 70, 120, 150*, 180, 271, 281
248	27	18	81°43.681	29°51.866	2812	26/07/2017	10, 45, 60, 90, 150, 280, 490, 650, 750, 900, 1200, 1800, 2400, 2760
283	34	32	78°50.067	23°50.399	172	29/07/2017	5, 23, 35, 50, 100, 150, 159
290	37	34	77°19.971	29°59.943	185	29/07/2017	10, 30, 65, 80, 120, 140, 175
329	40	35	75°29.996	30°00.044	362	31/07/2017	5, 18, 30, 50, 100, 200, 300, 348
349	42	36	75°06.000	28°04.230	330	01/08/2017	10, 30, 50, 80, 150, 200, 290, 317
351	44	37	75°56.975	28°34.697	54	02/08/2017	5, 20, 30, 40, 45
353	46	38	76°11.378	18°53.591	236	02/08/2017	5, 20, 30, 50, 100, 150, 175, 218, 228

Table 5.1.3. ^{15}N -AA of POM samples collected for ARISE. Volume pumped by the SAPS ranged from 111 L and 1287 L. The depths highlighted in red indicate occasions when the SAPS either failed to pump or became blocked with debris (i.e. jellyfish) that impeded the flow. In these cases the filters were discarded.

event	station	Latitude	Longitude	Bottom (m)	Date	Depths (m)
10	B2	71°42'N	19°40'E	256	8-Jul-17	10, 25, 45, 230
21	B4	73°22'N	18°55'E	476	9-Jul-17	10, 37, 75, 300
36	B6	75°11'N	17°32'E	145	10-Jul-17	8, 20,45, 100
50	B8	76°22'N	16°40'E	45	11-Jul-17	10, 18, 35
61	B10	76°N	10°40'E	2500	12-Jul-17	10, 15, 35, 250
73	B9	76°N	13°40'E	1000	13-Jul-17	10, 15, 25, 250
81	B11	76°22'N	21°E	230	14-Jul-17	15, 27, 50, 180
95	B12	75°30'N	26°E	135	15-Jul-17	10, 15, 37, 62
108	B13	74°30'N	30°E	363	16-Jul-17	5, 15, 30, 70
150	B15	78°30'N	30°E	330	18-Jul-17	15, 34, 70, 175
189	B16	80°06'N	30°E	278	22-Jul-17	5, 15, 30, 200
238	B17	81°24'N	29°30'E	292	25-Jul-17	5, 17, 40, 120
250	B18	81°44'N	29°51'E	2812	26-Jul-17	10, 45, 60, 280
299	B14	76°30'N	30°30'E	290	30-Jul-17	3, 48, 75, 269
360	B7	76°N	16°50'E	319	3-Aug-17	6, 28, 50, 250
368	B5	74°22'N	18°10'E	118.4	4-Aug-17	8, 25, 38, 108
377	B3	72°38'N	19°15'E	370	5-Aug-17	10, 25, 40, 340
414	B1	70°46'N	20°E	190	7-Aug-17	10, 27, 50, 140

Nutrient concentration data are available in the macronutrient section of this cruise report. No isotopic data are available yet as analysis will take place in UK laboratories.

5.2 Macronutrients

¹Tim Brand (SAMS), ^{1,2}Sian Henley (University of Edinburgh)

¹Author, ² Data set PI

Background and objectives

The basic water column dissolved nutrients, ammonium, phosphate, silicate (reactive silica), total oxidized nitrogen, TON, and at selected stations, nitrite, were analysed using a flow injection autoanalyser from 55 (out of a possible 59) CTD casts to fulfil the scientific objectives of the PRIZE and ARISE Science programs. A full list of nutrient samples taken and analysed is shown in Table 3.

Methods

Samples were collected in 50ml acid cleaned polythene vials from the CTD rosette. Initially, between the 8th and 21st July, samples were collected directly from the CTD bottle spigots. After this date, due to analyser blockage problems, the use of a 10cm acid cleaned silicon tube with a 200um nylon mesh filter at one end was used to pre-filter the sample prior to collection in the vial. Samples were always analysed within 24 hours of collection and stored in a refrigerator if they were not being analysed upon collection. All samples were allowed to equilibrate to room temperature for an hour before analysis. Measurement was conducted using a Lachat *QuikChem 8500* flow injection autoanalyser (Hach Lange) using the manufacturers recommended methods: Ammonium, 31-107-06-1-B; Orthophosphate, 31-115-01-1-G; Silicate, 31-114-27-1-A and Nitrate/Nitrite, 31-107-04-1-A. After analysis, the 50ml tubes were double rinsed with the ship's DI water and reused for subsequent CTD sample collection.

Samples were routinely measured in triplicate to identify analytical precision. Individual stock standard solutions of nitrate, phosphate and silicate were prepared in deionised water immediately prior to the cruise from oven dried (60C) salts. A primary mixed working standard solution was prepared each day from the stock solutions using the ship's DI water and the calibration standard solutions were prepared by the instruments autodiluter facility using OSIL Low Nutrient Sea Water for dilution, (OSIL, <http://www.osil.co.uk>, Batch LNS 25, Salinity 35). Five calibration standards and blank seawater were run at the start of each batch of samples followed by a drift standard run in triplicate at the end of the batch. The calibration drift determined was accounted for in the calculation of the sample result (arithmetic methodology assumes a linear calibration drift correction from start to finish of the sample batch).

Data quality

A standard reference solution prepared from nutrient standard solutions and low nutrient sea water supplied by OSIL containing 1 μM NH_4 , 1 μM PO_4 , 10 μM SiO_2 and 10 μM NO_3 was run at the start, during and end of the entire analysis to check accuracy of the dried salt derived standards. A second standard reference of Pacific Ocean water supplied by Kanso Co. (Japan) (Lot. CG) was also analysed at the start and end of the cruise

Analytical precision was gathered by running each sample in triplicate and regularly yielded relative standard deviations (R.S.D.) of better than 2% for ammonium, phosphate and nitrate and better than 5% for silicate for concentrations greater than 1 μM . Errors on concentrations less than 1 μM would be greater than these. The method detection limit (MDL) of each nutrient was measured on 5 sets of analyses and calculated as 3 x S.D. of 3 replicates of the low nutrient sea water blank. This yielded MDL's of NH_4 , 0.1 μM ; PO_4 , 0.1 μM ; SiO_2 , 0.2 μM , and NO_3+NO_2 , 0.1 μM .

Table 5.2.1: Accuracy, determined by analysing the independent OSIL and Kanso reference standard solutions at the beginning and end of the cruise showed mean values of NH₄, 95%; PO₄ 96%; SiO₂, 95%, NO₃+NO₂, 96%,

Date	11/07/2017	11/07/2017	03/08/2017	05/08/2017	05/08/2017	Mean
Standard	OSIL	Kanso	OSIL	OSIL	Kanso	
(%)	(%)	(%)	(%)	(%)	(%)	(%)
NH ₄	89.9		99.0	95.9		95
PO ₄	97.6	94.3	91.8	97.8	97.6	96
SiO ₂	94.7	96.9	98.8	90.1	94.2	95
NO _x	98.3	99.6	93.8	93.8	93.6	96

Table 5.2.2: Precision (relative standard deviation, %) , determined from the OSIL and Kanso standard reference solutions yield precision values similar to those for the batches of samples: NH₄, 1%, PO₄, 2%; SiO₂, 2%; NO₃+NO₂, 1%,

Date	11/07/2017	11/07/2017	03/08/2017	05/08/2017	05/08/2017	Mean
Standard	OSIL	Kanso	OSIL	OSIL	Kanso	
(%)	(%)	(%)	(%)	(%)	(%)	(%)
NH ₄	1.8		1.1	1.5		1
PO ₄	0.5	0.9	3.5	1.8	1.8	2
SiO ₂	2.9	2.4	4.0	1.5	0.4	2
NO _x	0.1	0.4	1.0	1.2	1.4	1

Instrument problems

During the course of the cruise the instrument experienced a rotary valve failure on the ammonium manifold and a rotary valve blockage on the phosphate manifold. Both incidents, which occurred on the same day (20th of July), were thought to be due to particulate material that had been present in the sample (phytoplankton, zooplankton) and/or dust material from the air conditioning vent in the laboratory introduced into the sample vials whilst sitting in the autosampler. Close inspection of some of the micro tubing connections did show signs of material blockage and were easily cleaned but this was not possible for the factory sealed units of the rotary valves. In response to this, a number of changes were made. To ensure the continued successful analysis of 4 nutrients it was necessary to analyse the sample initially for ammonium and silicate and then for each batch of samples reconfigure the micro tube connections so that the phosphate and nitrate manifolds were connected to the two working rotary port valves and then run the instrument for these nutrients. This meant that the analysis time doubled but ensured the samples could be analysed on board. Further changes made were the introduction of a small length of silicon tubing with a 200um nylon mesh filter at one end for collection of the sample from the CTD bottle spigot to remove the possibility of a large plankton and particulate material and the placement of a square of polypropylene mesh filter over the exit of the air conditioning vent into the laboratory to prevent dust ingress. No problems with the instrument occurred after the introduction of these measures. Because of the increased time of analysis, doubling of sample requirement and doubling of the low

nutrient sea water matrix used for the calibration standards, the separate run for nitrite analysis that had been performed up until this date was largely curtailed.

Table 5.2.3 CTD Samples analyzed

CTD cast	Station	Depths	Ammonium	Phosphate	Silicate	NOx	Nitrite	Filtered replicates	Analysis date
1	B1	8	√	√	√	√			08/07/2017
2	B2	11	√	√	√	√	√		08/07/2017
3	B4	15	√	√	√	√	√		09/07/2017
4	B6	10	√	√	√	√	√		10/07/2017
5	B8	11	√	√	√	√	√		11/07/2017
6	B7	12	√	√	√	√	√	√	11/07/2017
7	B21	12	√	√	√	√	√		12/07/2017
8	B10	8	√	√	√	√	√		13/07/2017
9	B10	14	√	√	√	√	√		13/07/2017
10	B19	12	√	√	√	√	√	√	13/07/2017
11	B9	10	√	√	√	√	√		14/07/2017
12	B9	9	√	√	√	√	√		14/07/2017
13	B20	13	√	√	√	√	√	√	14/07/2017
14	B11	13	√	√	√	√	√		15/07/2017
15	B22	9	√	√	√	√	√	√	15/07/2017
16	B12	13	√	√	√	√	√		15/07/2017
17	B13	14	√	√	√	√	√	√	17/07/2017
18	B13	11	√	√	√	√	√		18/07/2017
19	B15	15	√	√	√	√	√	√	20/07/2017
Valve failure									20/07/2017
20	B16	12	√	√	√	√	√	√	22/07/2017
21	B24	12	√	√	√	√			25/07/2017
22	B23	8	√	√	√	√			25/07/2017
23	B17	15	√	√	√	√		√	25/07/2017
24	B25	12	√	√	√	√			26/07/2017
25	B26	12	√	√	√	√			26/07/2017
26	B18	7	√	√	√	√	√		26/07/2017
27	B18	16	√	√	√	√			28/07/2017
28	B27	9	√	√	√	√			28/07/2017

29	B28	9	√	√	√	√			28/07/2017
30	B16	8	√	√	√	√			29/07/2017
31	B29	8	√	√	√	√			29/07/2017
32	B30	8	√	√	√	√			29/07/2017
33	B31	8	√	√	√	√			29/07/2017
34	B32	7	√	√	√	√			29/07/2017
35	B33	8	√	√	√	√			30/07/2017
36	B15	8	√	√	√	√			30/07/2017
37	B34	7	√	√	√	√			30/07/2017
38	B14	10	√	√	√	√	√		30/07/2017
40	B35	8	√	√	√	√			02/08/2017
41	B13	8	√	√	√	√			02/08/2017
42	B36	8	√	√	√	√			02/08/2017
43	B12	5	√	√	√	√			02/08/2017
44	B37	3	√	√	√	√			02/08/2017
45	B11	6	√	√	√	√			02/08/2017
46	B38	7	√	√	√	√			04/08/2017
47	B8	3	√	√	√	√			04/08/2017
48	B7	8	√	√	√	√			04/08/2017
50	B6	5	√	√	√	√			04/08/2017
52	B5	4	√	√	√	√			04/08/2017
54	B4	10	√	√	√	√			05/08/2017
55	B3	11	√	√	√	√	√	√	05/08/2017
56	B43	8	√	√	√	√			07/08/2017
57	B2	8	√	√	√	√	√		07/08/2017
58	B44	6	√	√	√	√			07/08/2017
59	B1	7	√	√	√	√	√		07/08/2017

In total 519 samples were collected and analyzed and a 113 of these were analyzed in duplicates as filtered and un-filtered samples.

5.3 POC, DOC and DOP

¹Elaine Mitchell (SAMS) and ²Keith Davidson (SAMS)

¹Author, ² Dataset PI

Arctic PRIZE

Water samples were taken at 17 sites throughout the Barent sea transect (B2-B18) at six depths representing decreasing light (PAR) levels. These depths match the water column samples taken for primary production incubations. Samples were taken for DOC, DOP & POC to support the findings of the primary productivity incubation experiments (Section 6.2).

Method

Water was collected from the Pelagic CTD from the same six bottles as those sampled for primary productivity. The water was pre-screened with a 200µm mesh at the end of blacked out acid washed silicone tubing and collected into 10L acid washed carboys and stored in black bags either in the cold room or on deck in a low light area. Location of the collected water for storage until processing was dependent on the temperature of the surface water at the point of collection.

Samples were processed as follows:

DOP – 50ml volumes of the collected samples were poured directly into acid washed 50ml centrifuge tubes. Samples were duplicated, bagged up for each station and taken directly to the -20°C freezer.

POC – 0.5-1L volumes were filtered through an ashed 25mm GF/F filter using acid washed filtration units. The filters were removed using Methanol dipped tweezers and transferred to a sterile micro-centrifuge tube. Samples were duplicated, bagged up for each station and taken directly to the -20°C freezer.

DOC – 20ml volumes were filtered through an ashed 25mm GF/F using individual acid washed glass syringes and swinex filter units for each sample and duplicated. Samples were fixed with 50µl 85% orthophosphoric acid before being bagged up for each station and transferred to the cold store. These samples will be analysed at SAMS.

Table of sites sampled and the CTD cast information can be found in the primary productivity section (Section 6.2).

6. Primary Production

6.1 Photosynthesis-irradiance incubations and photophysiology

^{1,2} Heather Bouman (Department of Earth Sciences, University of Oxford)

¹Author, ² Dataset PI

Arctic PRIZE

Background and objectives

The photosynthesis-irradiance curve describes the curvilinear response of phytoplankton photosynthesis to available light and can be described in the absence of photoinhibition using two parameters: the asymptote and initial slope. The accurate estimation of Arctic primary production rests on assignment of photosynthesis-irradiance parameters that are relevant for the Arctic region (Carr et al. 2006, IOCCG 2015). To address the current gap in our understanding of how the asymptote and initial slope change under varying sea-ice conditions, seawater samples were collected to determine the photosynthetic response of sub-arctic and arctic phytoplankton assemblages in the Barents Sea. These data will be used to obtain information on the photophysiology of the natural phytoplankton community and to derive parameters used in remotely-sensed models of marine primary production.

Sampling strategy/instrument description

PI experiments were conducted in a custom-built incubator holding 15 60ml polycarbonate bottles. The incubator window was covered with a Lee CT blue filter to diminish the spectral dependency of the light source. Samples were maintained at in situ temperatures throughout the incubation period using a circulating water bath. Each of the 60ml polycarbonate bottles are rinsed three times with sample water then filled to the shoulder in a low-light environment. 200 µl of ¹⁴C stock sodium bicarbonate solution is added to each of the 15 bottles (4 µCi added per bottle). The bottles were placed into the incubator and diffusing filters were spaced between bottles to obtain a gradient of light levels. A single dark bottle was also placed in the incubator to measure ¹⁴C incorporation in the dark. Bottles are incubated for 2 hours under the light gradient at ambient temperature.

The stock containing the ¹⁴C sodium bicarbonate solution is stored in the refrigerator until the next experiment is conducted. 200µl of stock solution was pipetted into a scintillation vial containing 100µl of hyamine hydroxide. 4 ml of scintillation cocktail (Optiphase Hi-Safe) were added, the cap is replaced and the solution is mixed well. Counts obtained from these vials were provided by the shipboard liquid scintillation counter in disintegrations per minute (DPM).

Methods

At the end of the incubation period, samples were filtered through GF/F filters at a vacuum pressure of 200 mm Hg. Filters are removed from the towers and carefully placed in order in a glass dessicator (in a fumehood) containing 200 – 300 ml of concentrated hydrochloric acid (HCl). The filters remain in the dessicator for 6 hours and then placed individually into numbered plastic scintillation vials. Scintillation cocktail are added to each vial and were counted in the scintillation counter onboard the ship. The light intensity inside of the incubator is measured using a Biospherical QSL2101 quantum scalar irradiance meter.

The biomass-normalised primary production, P^B , at each light level will be calculated from the formula:

$$P^B = ((DPM_{\text{light}} - DPM_{\text{dark}}) \times 12000 \times \text{ALK} \times 1.05) / ((DPM_{\text{add}} \times 500) \times N \times \text{Chl}),$$

where DPM_{light} is the counts in the light bottle, DPM_{dark} is the counts in the dark bottle, ALK is the carbonate alkalinity (Meq), 12000 converts Meq to $\mu\text{g C}$, 1.05 is the isotope discrimination factor, DPM_{add} is the counts from the flask inoculated with 200 μl of ^{14}C stock solution, 500 converts counts to total counts for the DPM_{add} flask, N is the duration of the incubation in hours and Chl is the chlorophyll concentration in $\mu\text{g l}^{-1}$. The units for P^B is $\mu\text{g C h}^{-1} (\mu\text{g Chl})^{-1}$ or $\text{mg C m}^{-3} \text{h}^{-1} (\text{mg Chl})^{-1}$.

References

Carr, M-E et al. (2006), Deep Sea Research II 53: 741–770

IOCCG (2015) Ocean Colour Remote Sensing in Polar Seas, IOCCG Report Series, No. 16

Samples collected

A detailed list of samples collected may be found in Table 6.1.1.

Table 6.1.1: List of water samples collected for photosynthesis-irradiance incubations.

Date collected	Time (UTC)	Latitude (N)	Longitude (E)	Station	Event	Depth (m)
08/07/2017	09:09	71.41997	19.39961	B2	E6	10
08/07/2017	09:09	71.41997	19.39961	B2	E6	25
09/07/2017	09:03	73.22068	18.55082	B4	E18	3
09/07/2017	09:03	73.22068	18.55082	B4	E18	37
10/07/2017	09:02	75.10993	17.32005	B6	E32	3
10/07/2017	09:02	75.10993	17.32005	B6	E32	20
11/07/2017	09:07	76.21986	16.3993	B8	E47	3
11/07/2017	09:07	76.21986	16.3993	B8	E47	18
12/07/2017	07:00	76.00008	10.40018	B10	E57	3
12/07/2017	07:00	76.00008	10.40018	B10	E57	15
13/07/2017	09:19	75.59998	13.40005	B9	E69	3
13/07/2017	09:19	75.59998	13.40005	B9	E69	18
14/07/2017	09:04	76.22	21.00109	B11	E78	3
14/07/2017	09:04	76.22	21.00109	B11	E78	27
15/07/2017	07:00	75.3	26.00203	B12	E90	3
15/07/2017	07:00	75.3	26.00203	B12	E90	15
16/07/2017	09:00	74.28	30.00019	B13	E105	3
16/07/2017	09:00	74.28	30.00019	B13	E105	15
18/07/2017	09:47	77.29	31.44	UW1	Na	3
19/07/2017	09:45	78.1286	30.00048	B15	E147	3
19/07/2017	09:45	78.1286	30.00048	B15	E147	26
22/07/2017	08:13	80.08924	29.54304	B16	E186	3
22/07/2017	08:13	80.08924	29.54304	B16	E186	15
24/07/2017	11:44	81.190317	29.162184	UW2	Na	3
25/07/2017	08:00	81.23926	29.2874	B17	E235	3

25/07/2017	08:00	81.23926	29.2874	B17	E235	17
26/07/2017	11:13	81.43554	29.52061	B18	E247	3
26/07/2017	11:13	81.43554	29.52061	B18	E247	35
28/07/2017	11:22	80.06009	30.00401	B16	E279	3
28/07/2017	11:22	80.06009	30.00401	B16	E279	17
29/07/2017	08:00	78.21991	26.10151	B33	E284	5
29/07/2017	08:00	78.21991	26.10151	B33	E284	10
30/07/2017	09:00	76.29965	30.17236	B14	E296	3
30/07/2017	09:00	76.29965	30.17236	B14	E296	48
02/08/2017	11:06	76.1138	18.53616	B38	E353	3
02/08/2017	11:06	76.1138	18.53616	B38	E353	20
03/08/2017	08:59	76.00009	16.50011	B7	E357	3
03/08/2017	08:59	76.00009	16.50011	B7	E357	28
04/08/2017	08:56	74.2199	18.09978	B5	E365	3
04/08/2017	08:56	74.2199	18.09978	B5	E365	25
05/08/2017	08:57	72.37984	19.15014	B3	E374	3
05/08/2017	08:57	72.37984	19.15014	B3	E374	25

6.2 Primary production deck incubations

¹ Elaine Mitchell (SAMS), ² Keith Davidson (SAMS)

¹Author, ² Dataset PI

Arctic PRIZE

Aim

To estimate primary production rates within the Barents Sea (Atlantic to Polar waters), at the high latitude shelf edge and in open Arctic waters to the East of Svalbard during the summer period of July- August (Stations B2 to B18). Primary production estimations were made using 24 hour on-deck incubations with ¹⁴C.

These measurements link to and are supported by:

- Primary production and primary irradiance experiments (Section 6.1)
- Phytoplankton community structure and biomass estimates, microbial community structure and abundance (Section 7.3)
- Chemical composition (Section 5.2), chlorophyll-a concentrations (Section 7.3), POC, DOC and DOP measurements (Section 5.3)

Methods

Sampling

Seawater was collected from six depths from a standard environmental CTD cast as close to midday as possible. The CTD was positioned to be in full sunlight and not in the shadow of the ship. Sampling depths were selected based on the PAR irradiance readings from the CTD at the surface of the water (approx. 2m) after being initially stabilised at 10m and brought back to the surface. Six set percentages of light 100%, 50%, 25%, 15%, 3% and 1% were calculated from the surface PAR (log) and the depths chosen accordingly. For primary production, the water was pre-screened with a 200µm mesh and collected into 500ml acid washed blacked out polycarbonate bottles using acid washed and blacked out tubing to minimise the impact of daylight on the samples. Samples were placed into a cool box and transferred to the radiation lab for dispensing within 30 minutes.

Incubations

Water from each of the six depths was dispensed into 60ml polycarbonate bottle, triplicated in light conditions with one fully blacked out polycarbonate bottle. Bottles were strung together with twine to make for easy dispatch and subsequent retrieval of the bottles from the deck incubators.

Dispensing was carried out as quickly as possible with full bottles being returned to the cool box and dark swiftly. Each bottle was spiked with 10µCi (370kBq) of NaH¹⁴CO³. Bottles were placed into the deck incubation tanks under their corresponding light percentage density filters, the tanks were cooled with a continuous flow of seawater from the non-toxic underway supply. The samples were incubated for 24 hours under continuous daylight conditions.

Filtrations

Following incubation each set of samples were removed to a dark cool box. They were filtered through 47mm 0.2µm Polycarbonate membrane filters under a low vacuum, fumed for ~1 hour over 32% HCL and then desiccated overnight (minimum of 12 hours) prior to the addition of 4ml of Optiphase Hisafe III scintillation cocktail. Once the cocktail was added they were stored in the dark for a minimum of 24 hours before being read using a Perkin Elmer Tricarb 2910TR Scintillation counter.

For each set of samples there were 3 blanks containing one plain filter with 4mls of Optiphase Hisafe III added and a set of three standards in triplicate using a 10 μ Ci spike in a mix of Optiphase Hisafe III cocktail, Carbosorb and deionised water in a ratio of 30:10:1 by volume.

These samples will be analysed again at SAMS to confirm the original data that has been obtained.

For details of sites and CTD information please refer to the table below:

Evt No.	Date	Start Time (GMT)	Station	Latitude	Longitude	Depth (m)	Activity	Comments	Lead
6	08/07/17	09:10	Station B2	71.4199 N	19.39959 E	256	CTD 002	Standard CTD for Observations. Depths sampled – 5m, 25m, 60m, 70m, 80m, 120m	Elaine
18	09/07/17	08:59	Station B4	73.22068 N	18.55083 E	469	CTD 003	Standard CTD for Observations. Depths sampled – 3m, 7m, 15m, 22m, 37m, 50m	Elaine
32	10/07/17	09:01	Station B6	75.10994 N	17.32004 E	141	CTD 004	Standard CTD for Observations. Depths sampled – 3m, 5m, 8m, 15m, 20m, 25m	Elaine
47	11/07/17	09:06	Station B8	76.21986 N	16.39931 E	40	CTD 005	Standard CTD for Observations. Depths sampled – 3m, 5m, 8m, 9m, 18m, 20m	Elaine
57	12/07/17	07:07	Station B10	76.00008 N	10.40021 E	2260	CTD 008	Standard CTD for Observations. Depths sampled – 3m, 5m, 7m, 8m, 15m, 25m	Elaine
69	13/07/17	09:19	Station B9	75.59998 N	13.40007 E	300	CTD 012	Standard CTD for Observations. Depths sampled – 3m, 6m, 10m, 12m, 20m, 30m	Elaine
78	14/07/17	09:03	Station B11	76.220 N	21.00110 E	225	CTD 014	Standard CTD for Observations. Depths sampled – 3m, 7m, 12m, 15m, 30m, 50m	Elaine
90	15/07/17	07:03	Station B12	75.3000 N	26.00106 E	135	CTD 016	Standard CTD for Observations. Depths sampled – 3m, 6m, 12m, 15m, 30m, 50m	Elaine
105	16/07/17	09:02	Station B13	74.2800 N	30.0017 E	355	CTD 017	Standard CTD for Observations. Depths sampled – 3m, 5m, 8m, 12m, 22m, 30m	Elaine
147	19/07/17	09:30	Station B15	78.12861 N	30.00046 E	330	CTD 019	Standard CTD for Observations. Depths sampled – 3m, 8m, 15m, 22m, 26m, 34m	Elaine
186	22/07/17	08:03	Station B16	80.09074 N	29.54892 E	275	CTD 020	Standard CTD for Observations. Depths sampled – 3m, 5m, 12m, 15m, 25m, 40m	Elaine
235	25/07/17	08:00	Station B17	81.24009 N	29.30184 E	290	CTD 023	Standard CTD for Observations. Depths sampled – 3m, 4m, 5m, 8m, 12m, 17m	Elaine
247	26/07/17	11:05	Station B18	81.43554 N	29.52064 E	2790	CTD 026	Standard CTD for Observations. Depths sampled – 3m, 6m, 14m, 20m, 35m, 50m	Elaine

296	30/07/17	09:02	Station B14	76.29965 N	30.17224 E	290	CTD 038	Standard CTD for Observations. Depths sampled – 3m, 6m, 16m, 22m, 35m, 48m	Elaine
357	03/08/17	08:59	Station B7	76.00008 N	16.50014 E	319	CTD 048	Standard CTD for Observations. Depths sampled – 3m, 6m, 12m, 18m, 28m, 50m	Elaine
365	04/08/17	08:55	Station B5	74.21989 N	18.09978 E	118	CTD 52	Standard CTD for Observations. Depths sampled - 3m, 8m, 16m, 25m, 32m, 45m	Elaine
374	05/08/17	08:57	Station B3	72.37984 N	19.15011E	366	CTD 55	Standard CTD for Observations. Depths sampled – 3m, 6m, 12m, 25m, 30m, 40m	Elaine

7. Phytoplankton and microbial community

7.1 Optical properties and pigments

¹Andrew Orkney (Department of Earth Sciences, University of Oxford) and ^{1,2}Heather Bouman (Department of Earth Sciences, University of Oxford)

¹Author, ² Dataset PI

Arctic PRIZE

Background and objectives

Arctic-Prize aims to contrive a means by which the community structure and biogeochemical significance of key phytoplankton groups' activity can be inferred from future satellite retrievals. To this end, samples were collected to determine the concentrations and optical properties of Barents Sea phytoplankton pigments through Turner fluorometry, spectrophotometric analysis and High Performance Liquid Chromatography (HPLC).

7.1.1 Fluorometric chlorophyll-a

Objectives

Measurements of chlorophyll-a were taken from discrete water samples along the cruise transect. The vertical profiles of chlorophyll-a concentration will be used to calibrate *in vivo* fluorescence profiles made using an *in situ* fluorometer mounted on the CTD rosette system.

Sampling strategy

Seawater samples were collected from the CTD in 5 litre Nalgene carboys. Each carboy was rinsed twice with sample water and then filled. Triplicate samples of 200ml were filtered through 25mm GF/F filters. The filters were placed in 10ml of 90% acetone in 20ml glass scintillation vials and stored overnight at -20°C to facilitate pigment extraction.

Methods

The samples were analysed onboard using a Trilogy Fluorometer (Turner Designs). The fluorometer was pre-calibrated prior to the cruise, using spinach chlorophyll-a standard (Sigma). The pigment extract was measured both before and after acidification according to the method of Holm-Hansen et al., (1965).

Samples collected

A complete list of the samples collected on the JR16006 cruise can be found in Table 7.1.1. In general, 4 depths were sampled at each station, always including the surface and the SCM, as indicated by the CTD onboard fluorometer. Photophysiological experiments were conducted at the surface and SCM depths by Dr. Heather Bouman (see section 6.1).

Preliminary results

Chlorophyll-a concentrations varied by over an order of magnitude across the transect. Repeated stations exhibited varying chlorophyll-a concentrations and profiles, meaning that the variation has both spatial and temporal components.

Surface concentrations of chlorophyll-a varied between 0.18 mg m⁻³ at station B4 event E18 08/07/2017 and 6.02 mgm⁻³ in an under-way sample UW2 on 24/07/2017.

A maximum chlorophyll-a concentration of 10.9 mg m⁻³ was recorded at station B16 on 28/07/2017, when the station was visited after a recent recession of the sea ice. See Table 7.1.1 for further detail.

Preliminary results indicate the chlorophyll-a concentrations were highest at the ice edge, where the vertical distribution of chlorophyll-a often manifested with a pronounced Subsurface Chlorophyll Maximum (SCM), whereas open ocean stations were more likely to exhibit lower and more homogenised vertical distributions of chlorophyll-a.

Figure 7.1.1 Vertical profiles of chlorophyll-a concentration measured onboard using the fluorometric method.

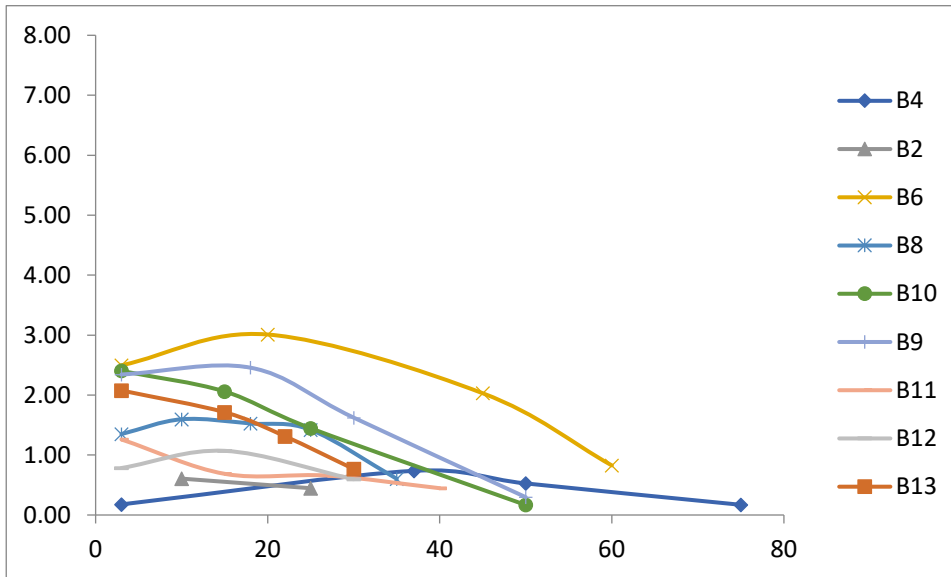

Figure 7.1.1 (a): Open ocean chlorophyll-a vertical distributions. [Chl-a] along y-axis (mg m^{-3}), depth along x-axis (m).

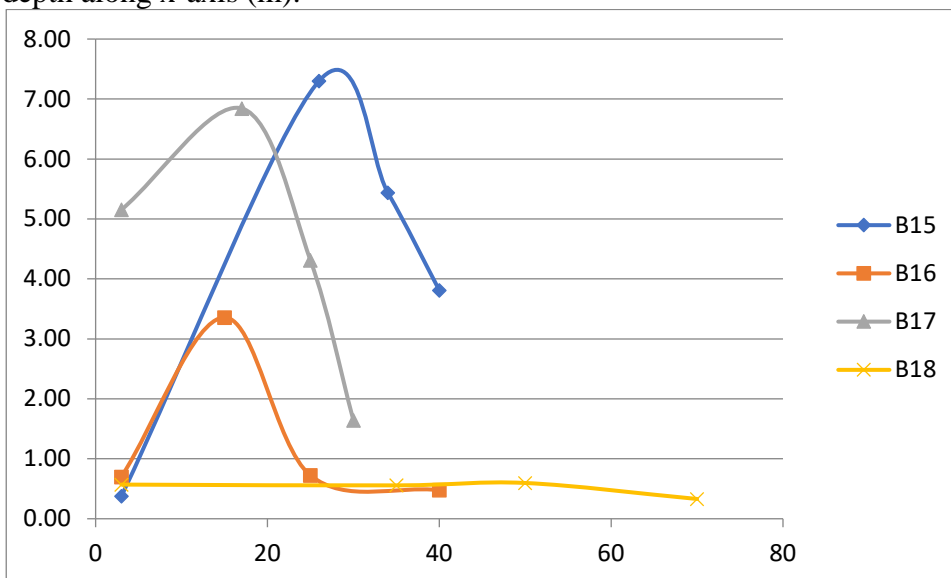

Figure 7.1.1 (b): Ice covered ocean chlorophyll-a vertical distributions. [Chl-a] along y-axis (mg m^{-3}), depth along x-axis (m). B18 represents the only station north of the shelf-break.

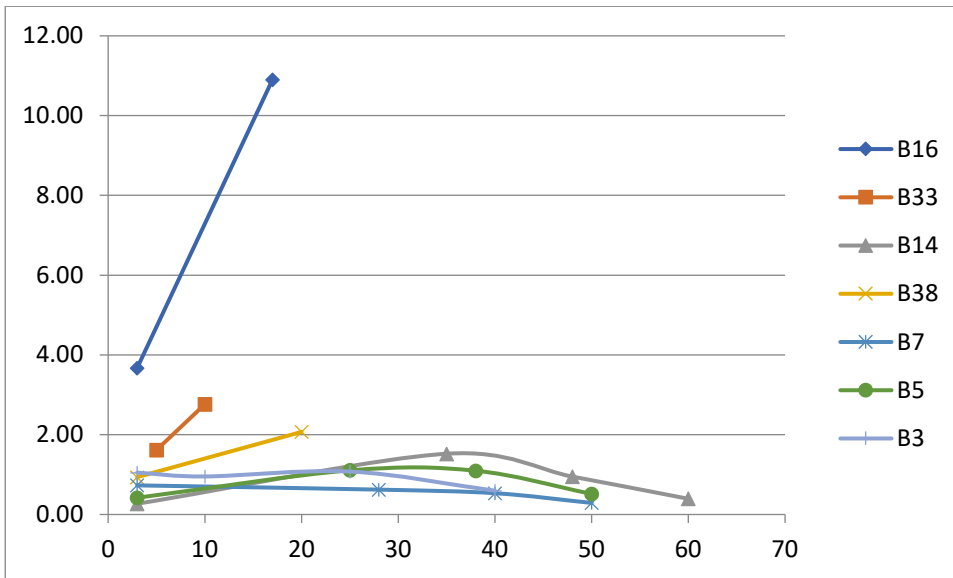

Figure 7.1.1 (c): Further open ocean stations south of the ice edge. B16 was re-sampled because the ice edge had receded from it. [Chl-a] along y-axis (mg m^{-3}), depth along x-axis (m).

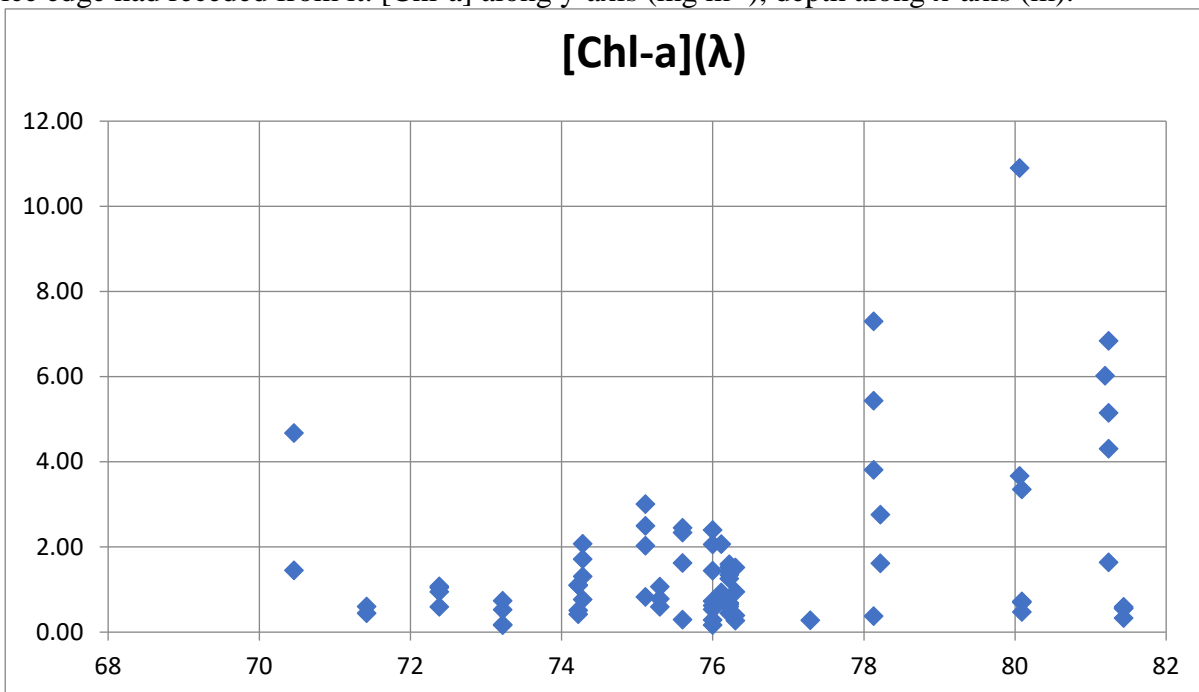

Figure 7.1.1 (d): A synopsis of the variation in chlorophyll-a concentration (along y-axis in mg m^{-3}), as a function of latitude (x-axis). Samples represent a range of depths.

7.1.2 High Performance Liquid Chromatography Analysis of Phytoplankton Pigments

Objectives

2-4 photic zone depths were sampled at each station in order to collect phytoplankton pigments. Specific phytoplankton pigments are characteristic of different taxonomic groups of phytoplankton that have key roles in biogeochemical cycles. Phytoplankton pigments contribute to variability between different phytoplankton absorption spectra because of their roles absorbing incident light. Hence investigation of phytoplankton groups' pigment complement will provide insight into the origin of phytoplankton groups' optical properties.

Sampling strategy

Between 500ml and 1 litre of seawater was subsampled from 5 litre Nalgene carboys and filtered through 25mm GF/F filters. The filters were then placed in 2ml cryovials and flash frozen in liquid nitrogen. Frozen cryovials were subsequently transferred to a -80°C freezer for long-term storage. Volumes under 500 ml were occasionally filtered when filters saturated, most often due to high phytoplankton concentrations causing congestion.

Methods

Frozen samples are to be transported to the University of Oxford Earth Sciences department in a dry shipper for storage at -80°C before their subsequent transfer to Trondheim for analysis.

Samples collected

Sample depths were identical to fluorometric and optical property samples. When plural depths were sampled the surface and SCM, as indicated by the *in situ* CTD fluorometer, were always included. A complete list of collected samples is available in Table 7.1.1.

7.1.3 Absorption by Marine Particulates

Objectives

When marine phytoplankton exist at sufficient abundance their presence can bias the absorption spectrum of sea water. Hence synoptic satellite measurements of sea surface reflectance can be used to observe the optical properties of seawater and potentially infer the concentration of characteristic phytoplankton groups at the surface. It is necessary to collect *in situ* samples of marine Barents Sea phytoplankton for analysis with a spectrophotometer so that any characteristic optical properties of different phytoplankton groups, that could be used to interpret satellite retrievals, can be identified.

Sampling strategy

Between 500 ml and 1 litre of seawater was subsampled from 5 litre Nalgene carboys and filtered through 25 mm GF/F filters. The filters were then placed in 2 ml cryovials and flash frozen in liquid nitrogen. Frozen cryovials were subsequently transferred to a -80°C freezer for long-term storage. Volumes under 500 ml were occasionally filtered when filters saturated, most often due to high phytoplankton concentrations causing congestion. An attempt was made to select a volume for filtration that resulted in conspicuous colour and low opacity.

Methods

Frozen samples are to be transported to the University of Oxford Earth Sciences department in a dry shipper for storage at -80°C before their subsequent analysis using a spectrophotometer.

Samples collected

Sample depths were identical to fluorometric and HPLC samples. When plural depths were sampled the surface and SCM, as indicated by the *in situ* CTD fluorometer, were always included. A complete list of collected samples is available in Table 7.1.1.

7.2 Coccolithophore abundance and taxonomy

¹Andrew Orkney (Department of Earth Sciences, University of Oxford), ¹ Heather Bouman (Department of Earth Sciences, University of Oxford), ² Alex Poulton (Heriot-Watt University)
¹Author, ² Dataset PI

At the request of Dr. Alex Poulton (Heriot-Watt University) additional samples of seawater were filtered for the collection of coccolithophores in order to assess their abundance and taxonomy.

7.2.1 Coccolithophore abundance

Objectives

An assessment of coccolithophore abundance will provide an indication of their relative importance in roles as primary producers and in biogeochemical cycles.

Sampling strategy

Between 200ml and 500ml of seawater was subsampled from 5 litre Nalgene carboys and filtered through 0.8µm cellulose filters. The filters were rinsed with a buffered milliQ solution to remove salt and filter-dried, before their transfer onto a Petri dish. Petri dishes containing filters were then heated in an oven at 50°C for 8-10 hours to dry the samples.

Volumes under 200ml were occasionally filtered when filters saturated, most often due to high phytoplankton concentrations causing congestion.

Methods

Dried samples will be returned to the National Oceanographic Centre (NOC) for analysis under Scanning Electron-Tunnelling Microscope (SEM).

Samples collected

In general seawater was subsampled for coccolithophore abundance at the surface and SCM, as indicated by the CTD's onboard fluorometer, at each station. A complete list of collected samples is available in Table 7.1.1.

7.2.2 Coccolithophore taxonomy

Objectives

An assessment of coccolithophore taxonomy will provide an indication of the relative dominance of different coccolithophore phylogenetic groups and their significance in the roles coccolithophores play as primary producers and biogeochemical cyclers.

Sampling strategy

Between 200ml and 500ml of seawater was subsampled from 5 litre Nalgene carboys and filtered through 0.8µm nucleopore filters. The filters were rinsed with a buffered milliQ solution to remove salt and filter-dried, before their transfer onto a Petri dish. Petri dishes containing filters were then heated in an oven at 50°C for 8-10 hours to dry the samples.

Volumes under 200ml were occasionally filtered when filters saturated, most often due to high phytoplankton concentrations causing congestion.

Samples collected

In general seawater was subsampled for coccolithophore taxonomy at the surface and SCM, as indicated by the CTD's onboard fluorometer, at each station. A complete list of collected samples is available in Table 7.1.1.

Table 7.1.1. Optics (O), HPLC (H), Fluorometry (F), Coccolith Nucleopore (CN), Coccolith Cellulose (CC))

Date collected	Time (UTC)	Latitude (N)	Longitude (E)	Station	Event	Depth (m)	O	H	F	CN	CC	Mean [chl] (mg m-3)
07/07/2017	17:04	70.45996	20.00031	B1	E1	10	x	x	x			
07/07/2017	17:04	70.45996	20.00031	B1	E1	16.5	x	x	x			4.68
08/07/2017	09:09	71.41997	19.39961	B2	E6	10	x	x	x			0.61
08/07/2017	09:09	71.41997	19.39961	B2	E6	25	x	x	x			0.45
09/07/2017	09:03	73.22068	18.55082	B4	E18	3	x	x	x			0.18
09/07/2017	09:03	73.22068	18.55082	B4	E18	37	x	x	x			0.74
09/07/2017	09:03	73.22068	18.55082	B4	E18	50	x	x	x			0.53
09/07/2017	09:03	73.22068	18.55082	B4	E18	75	x	x	x			0.17
10/07/2017	09:02	75.10993	17.32005	B6	E32	3	x	x	x	x	x	2.5
10/07/2017	09:02	75.10993	17.32005	B6	E32	20	x	x	x	x	x	3.01
10/07/2017	09:02	75.10993	17.32005	B6	E32	45	x	x	x	x	x	2.03
10/07/2017	09:02	75.10993	17.32005	B6	E32	60	x	x	x	x	x	0.83
11/07/2017	09:07	76.21986	16.3993	B8	E47	3	x	x	x	x	x	1.35
11/07/2017	09:07	76.21986	16.3993	B8	E47	10	x	x	x	x	x	1.6
11/07/2017	09:07	76.21986	16.3993	B8	E47	18	x	x	x	x	x	1.53
11/07/2017	09:07	76.21986	16.3993	B8	E47	25	x	x	x	x	x	1.42
11/07/2017	09:07	76.21986	16.3993	B8	E47	35	x	x	x	x	x	0.6
12/07/2017	07:00	76.00008	10.40018	B10	E57	3	x	x	x	x	x	2.4
12/07/2017	07:00	76.00008	10.40018	B10	E57	15	x	x	x	x	x	2.06
12/07/2017	07:00	76.00008	10.40018	B10	E57	25	x	x	x	x	x	1.45
12/07/2017	07:00	76.00008	10.40018	B10	E57	50	x	x	x	x	x	0.17
13/07/2017	09:19	75.59998	13.40005	B9	E69	3	x	x	x	x	x	2.34
13/07/2017	09:19	75.59998	13.40005	B9	E69	18	x	x	x	x	x	2.46
13/07/2017	09:19	75.59998	13.40005	B9	E69	30	x	x	x	x	x	1.62
13/07/2017	09:19	75.59998	13.40005	B9	E69	50	x	x	x	x	x	0.3
14/07/2017	09:04	76.22	21.00109	B11	E78	3	x	x	x	x	x	1.26
14/07/2017	09:04	76.22	21.00109	B11	E78	15	x	x	x	x	x	0.69
14/07/2017	09:04	76.22	21.00109	B11	E78	27	x	x	x	x	x	0.66
14/07/2017	09:04	76.22	21.00109	B11	E78	40	x	x	x			0.45
15/07/2017	07:00	75.3	26.00203	B12	E90	3	x	x	x	x	x	0.78
15/07/2017	07:00	75.3	26.00203	B12	E90	15	x	x	x	x	x	1.07
15/07/2017	07:00	75.3	26.00203	B12	E90	30	x	x	x			0.6
16/07/2017	09:00	74.28	30.00019	B13	E105	3	x	x	x	x	x	2.08
16/07/2017	09:00	74.28	30.00019	B13	E105	15	x	x	x	x	x	1.71
16/07/2017	09:00	74.28	30.00019	B13	E105	22	x	x	x			1.31
16/07/2017	09:00	74.28	30.00019	B13	E105	30	x	x	x			0.77

18/07/2017	09:47	77.29	31.44	UW1	Na	3	x	x	x			0.28
19/07/2017	09:45	78.1286	30.00048	B15	E147	3	x	x	x	x	x	0.38
19/07/2017	09:45	78.1286	30.00048	B15	E147	26	x	x	x	x	x	7.3
19/07/2017	09:45	78.1286	30.00048	B15	E147	34	x	x	x			5.44
19/07/2017	09:45	78.1286	30.00048	B15	E147	40	x	x	x			3.81
22/07/2017	08:13	80.08924	29.54304	B16	E186	3	x	x	x	x	x	0.7
22/07/2017	08:13	80.08924	29.54304	B16	E186	15	x	x	x	x	x	3.36
22/07/2017	08:13	80.08924	29.54304	B16	E186	25	x	x	x			0.72
22/07/2017	08:13	80.08924	29.54304	B16	E186	40	x	x	x			0.48
24/07/2017	11:44	81.190317	29.162184	UW2	Na	3	x	x	x			6.02
25/07/2017	08:00	81.23926	29.2874	B17	E235	3	x	x	x	x	x	5.15
25/07/2017	08:00	81.23926	29.2874	B17	E235	17	x	x	x	x	x	6.84
25/07/2017	08:00	81.23926	29.2874	B17	E235	25	x	x	x			4.31
25/07/2017	08:00	81.23926	29.2874	B17	E235	30	x	x	x			1.64
26/07/2017	11:13	81.43554	29.52061	B18	E247	3	x	x	x	x	x	0.57
26/07/2017	11:13	81.43554	29.52061	B18	E247	35	x	x	x	x	x	0.56
26/07/2017	11:13	81.43554	29.52061	B18	E247	50	x	x	x			0.6
26/07/2017	11:13	81.43554	29.52061	B18	E247	70	x	x	x			0.33
28/07/2017	11:22	80.06009	30.00401	B16	E279	3	x	x	x	x	x	3.67
28/07/2017	11:22	80.06009	30.00401	B16	E279	17	x	x	x	x	x	10.9
29/07/2017	08:00	78.21991	26.10151	B33	E284	5	x	x	x	x	x	1.62
29/07/2017	08:00	78.21991	26.10151	B33	E284	10	x	x	x	x	x	2.76
30/07/2017	09:00	76.29965	30.17236	B14	E296	3	x	x	x	x	x	0.27
30/07/2017	09:00	76.29965	30.17236	B14	E296	35	x	x	x			1.52
30/07/2017	09:00	76.29965	30.17236	B14	E296	48	x	x	x	x	x	0.95
30/07/2017	09:00	76.29965	30.17236	B14	E296	60	x	x	x			0.39
02/08/2017	11:06	76.1138	18.53616	B38	E353	3	x	x	x	x	x	0.94
02/08/2017	11:06	76.1138	18.53616	B38	E353	20	x	x	x	x	x	2.07
03/08/2017	08:59	76.00009	16.50011	B7	E357	3	x	x	x	x	x	0.73
03/08/2017	08:59	76.00009	16.50011	B7	E357	28	x	x	x	x	x	0.62
03/08/2017	08:59	76.00009	16.50011	B7	E357	40	x	x	x			0.53
03/08/2017	08:59	76.00009	16.50011	B7	E357	50	x	x	x			0.29
04/08/2017	08:56	74.2199	18.09978	B5	E365	3	x	x	x	x	x	0.42
04/08/2017	08:56	74.2199	18.09978	B5	E365	25	x	x	x	x	x	1.11
04/08/2017	08:56	74.2199	18.09978	B5	E365	38	x	x	x			1.1
04/08/2017	08:56	74.2199	18.09978	B5	E365	50	x	x	x			0.52
05/08/2017	08:57	72.37984	19.15014	B3	E374	3	x	x	x	x	x	1.05
05/08/2017	08:57	72.37984	19.15014	B3	E374	10	x	x	x			0.95
05/08/2017	08:57	72.37984	19.15014	B3	E374	25	x	x	x			1.08
05/08/2017	08:57	72.37984	19.15014	B3	E374	40	x	x	x			0.6

7.3 Flowcytometry and taxonomy

¹ Elaine Mitchell (SAMS), ² Keith Davidson (SAMS)

¹Author, ² Dataset PI

Arctic PRIZE

Water samples were taken at 17 sites throughout the Barent Sea transect (B2-B18) at six depths representing decreasing light (PAR) levels. These depths match the water column samples taken for primary production incubations (Section 6.2). Samples were taken for flowcytometry, taxonomy and chlorophyll-a.

7.3.1 Flowcytometry and taxonomy

Flowcytometry will provide us with information on the microbial community abundance of bacteria and nanno-flagellates. Taxonomic study of the phytoplankton assemblages and calculation of the biomass will support the findings of the primary productivity incubation experiments.

Method

Water was collected from the Pelagic CTD from those bottles sampled for primary productivity at three set depths – surface, chlorophyll max and deep. The water was pre-screened with a 200µm mesh at the end of blacked out acid washed silicone tubing and collected into 1L acid washed Nalgene bottles and stored in a cool box either in the cold room or on deck in low light area. Location of the collected water for storage until processing was dependent on the temperature of the surface water at the point of collection.

Samples were processed as follows:

Flowcytometry – 4mls of each sample is transferred into a 5ml cryovial, samples are duplicated. 200µl of paraformaldehyde was added to each tube. Samples were left in the cold and dark for an hour before flash freezing in liquid nitrogen. Samples were then transferred to an individual labelled bag with the site details and placed into a -80°C freezer for storage.

Taxonomy – 400mls of sample was transferred to a 500ml amber glass bottle containing 4mls of Lugol's iodine for preservation of phytoplankton. A further 400mls of sample was transferred into a 500ml amber Nalgene bottle containing 10mls of 37% Formaldehyde for preservation of coccolithophores. Both sets of samples were stored in the cold store.

These samples will be analysed at SAMS.

Table of sites sampled and the CTD cast information can be found in the primary productivity section (Section 6.2).

7.3.2 Chlorophyll-a

Method

Water was collected from the Pelagic CTD from the same six bottles as those sampled for primary productivity. The water was pre-screened with a 200µm mesh at the end of blacked out acid washed silicone tubing and collected into 10L acid washed carboys and stored in black bags either in the cold room or on deck in low light area. Location of the collected water for storage until processing was dependent on the temperature of the surface water at the point of collection.

Samples were processed as follows:

Between 0.5-1L of sample was filtered through a 47mm GF/F filter using a DI water rinsed filtration unit, samples were duplicated. The filter was then transferred to a labelled 15ml centrifuge tube and bagged according to site before being frozen at -20°C.

These samples will be analysed at SAMS.

Table of sites sampled and the CTD cast information can be found in the primary productivity section (Section 6.2).

7.4 Fatty acids and pigments

¹ Sarah Reed (SAMS), ² David Pond (SAMS)

¹Author, ² Dataset PI

DIAPOD

Background and objectives

The DIAPOD project is run by the Scottish Marine Association and is part of the NERC Changing Arctic Ocean Research Programme. *Calanus* copepods seasonally migrate into deeper waters to save energy and reduce their losses to predation in an overwintering process called diapause. The aim of DIAPOD is to understand, predict and model this biological reaction. We wish to understand what changes will happen if the Arctic sea ice keeps retreating at the same rate it is now. Fatty acid and pigment analysis will be used in comparison to the total community of zooplankton measured and lipid extraction (Section 8.1) to begin to predict how the productivity of the Arctic Ocean will change with the timing of the changing sea ice conditions.

Sampling strategy

Taking water from the CTD, 1 L for each depth from surface water (0 – 3 m) and chlorophyll maximum (ranging 10 – 50 m depending on the station) was filtered separately for fatty acid and pigment analysis.

This analysis will be used to compare against community analysis and lipid content of *Calanus* copepods taken from the zooplankton nets seen in Section 8.

Methods

Water was taken from the niskins on the CTD rosette at the chosen depth and then filtered through GF/Fs filters of 47 mm for fatty acid and then preserved in Chloroform:methanol and then stored in the -80 freezer. Water was also filtered for both depths through a 32 mm GF/F for pigment analysis and then stored in the -80 freezer. Analysis will be completed back at SAMs.

Data quality notes/ problems

There were no significant sample collection or data quality issues to note.

Samples collected

Table 7.4.1: Fatty Acid samples (UW = underway sample)

JR16006 Event number	Sample no. ID	Date	Latitude	Longitude	Station no.	Time (UTC)	Preservation	Depth (m)
UW	UFA1	3.7.17	58.76449	4.14278	UW	530	-80 2:1 chloro:methanol	200
UW	UFA3	3.7.17	59.22302	4.16687	UW	800	-80 2:1 chloro:methanol	270
UW	UFA5	3.7.17	59.52779	4.16671	UW	1100	-80 2:1 chloro:methanol	260
UW	UFA7	3.7.17	60.07633	4.27889	UW	1400	-80 2:1 chloro:methanol	281
UW	UFA9	4.7.17	60.07633	4.27889	UW	500	-80 2:1 chloro:methanol	214
UW	UFA11	4.7.17	62.12307	4.16704	UW	800	-80 2:1 chloro:methanol	216
UW	UFA13	4.7.17	62.56036	4.16833	UW	1100	-80 2:1 chloro:methanol	901
UW	UFA15	4.7.17	62.85877	4.16804	UW	1400	-80 2:1 chloro:methanol	1243
UW	UFA17	5.7.17	63.31577	4.57033	UW	500	-80 2:1 chloro:methanol	287
UW	UFA19	5.7.17	65.25455	6.64869	UW	805	-80 2:1 chloro:methanol	410
UW	UFA21	5.7.17	65.63287	7.07557	UW	1100	-80 2:1 chloro:methanol	425
UW	UFA23	5.7.17	65.87817	7.35602	UW	1400	-80 2:1 chloro:methanol	397
UW	UFA25	6.7.17	66.37419	7.92718	UW	510	-80 2:1 chloro:methanol	986
UW	UFA27	6.7.17	68.18469	10.21356	UW	710	-80 2:1 chloro:methanol	1102

UW	UFA29	6.7.17	68.45476	10.99565	UW	800	-80 2:1 chloro:methanol	1602
UW	UFA31	6.7.17	68.63016	11.52661	UW	1100	-80 2:1 chloro:methanol	1991
6	B2FA33	8.7.17	71.69998	19.66598	B2	911	-80 2:1 chloro:methanol	256
6	B2FA35	8.7.17	71.69998	19.66598	B2	911	-80 2:1 chloro:methanol	256
18	B4FA37	9.7.17	76.36629	16.64909	B4	857	-80 2:1 chloro:methanol	469
18	B4FA39	9.7.17	76.36629	16.64909	B4	857	-80 2:1 chloro:methanol	469
32	B6FA41	10.7.17	75.18323	17.5334	B6	902	-80 2:1 chloro:methanol	141
32	B6FA43	10.7.17	75.18323	17.5334	B6	902	-80 2:1 chloro:methanol	141
47	B8FA45	11.7.17	76.36644	16.66549	B8	907	-80 2:1 chloro:methanol	41
47	B8FA47	11.7.17	76.36644	16.66549	B8	907	-80 2:1 chloro:methanol	41
58	B10FA49CM	12.7.17	75.99998	13.6667	B10	902	-80 2:1 chloro:methanol	2260
58	B10FA510	12.7.17	75.99998	13.6667	B10	902	-80 2:1 chloro:methanol	2260
69	B9FA53CM	13.7.17	75.99996	13.66673	B9	846	-80 2:1 chloro:methanol	1027
69	B9FA550	13.7.17	75.99996	13.66673	B9	846	-80 2:1 chloro:methanol	1027
78	B11FA57CM	14.7.17	76.36613	21.00184	B11	902	-80 2:1 chloro:methanol	228
78	B11FA590	14.7.17	76.36613	21.00184	B11	902	-80 2:1 chloro:methanol	228
90	B12FA61-0	15.7.17	75.50022	26.0018	B12	856	-80 2:1 chloro:methanol	135
90	B12FA63 CM	15.7.17	75.50022	26.0018	B12	856	-80 2:1 chloro:methanol	135
105	B13FA65-0	16.7.17	74.46658	30.00033	B13	905	-80 2:1 chloro:methanol	355
105	B13FA67 CM	16.7.17	74.46658	30.00033	B13	905	-80 2:1 chloro:methanol	355
147	B15FA69 CM	19.7.17	78.21435	30.00075	B15	930	-80 2:1 chloro:methanol	315
147	B15FA71-0	19.7.17	78.21435	30.00075	B15	930	-80 2:1 chloro:methanol	315
186	B16FA73 CM	22.7.17	80.15129	29.91463	B16	945	-80 2:1 chloro:methanol	291
186	B16FA75-0	22.7.17	80.15129	29.91463	B16	945	-80 2:1 chloro:methanol	291
235	B17FA77-CM	25.7.17	81.40176	29.50352	B17	800	-80 2:1 chloro:methanol	300
235	B17FA79	25.7.17	81.40176	29.50352	B17	800	-80 2:1 chloro:methanol	300
247	B18FA81CM	26.7.17	81.7266	29.86902	B18	1132	-80 2:1 chloro:methanol	1200
247	B18FA83-0	26.7.17	81.7266	29.86902	B18	1132	-80 2:1 chloro:methanol	1200
296	B14Fa85cm	30.7.17	76.49942	30.28672	B18	902	-80 2:1 chloro:methanol	290
296	B14FA870	30.7.17	76.49942	30.28672	B14	92	-80 2:1 chloro:methanol	290
357	B7FA910	3.8.17	76.00026	816.96688	B7	934	-80 2:1 chloro:methanol	378
357	B7FA93CM	3.8.17	76.00026	816.96688	B7	934	-80 2:1 chloro:methanol	318
365	B5FA93CM	4.8.17	74.36651	18.16664	B5	588	-80 2:1 chloro:methanol	118
365	B5FA950	4.8.17	74.36651	18.16664	B5	855	-80 2:1 chloro:methanol	118
374	B3FA97CM	5.8.17	72.63316	19.25008	B3	900	-80 2:1 chloro:methanol	365
374	B3FA9790	5.8.17	72.63316	19.25008	B3	900	-80 2:1 chloro:methanol	365

Table 7.4.2: Pigment samples

JR16006 Event number	Sample no. ID	Date	Latitude	Longitude	Station no.	Time (UTC)	Preservation	Depth (m)
UW	UP2	3.7.17	58.76449	4.14278	UW	530	In vial in freezer	200
UW	UP4	3.7.17	59.22302	4.16687	UW	800	In vial in freezer	270
UW	UP6	3.7.17	59.52779	4.16671	UW	1100	In vial in freezer	260
UW	UP8	3.7.17	60.07633	4.27889	UW	1400	In vial in freezer	281
UW	UP10	4.7.17	60.07633	4.27889	UW	500	In vial in freezer	214
UW	UP12	4.7.17	62.12307	4.16704	UW	800	In vial in freezer	216
UW	UP14	4.7.17	62.56036	4.16833	UW	1100	In vial in freezer	901
UW	UP16	4.7.17	62.85877	4.16804	UW	1400	In vial in freezer	1243
UW	UP18	5.7.17	63.31577	4.57033	UW	500	In vial in freezer	287
UW	UP20	5.7.17	65.25455	6.64869	UW	805	In vial in freezer	410
UW	UP22	5.7.17	65.63287	7.07557	UW	1100	In vial in freezer	425
UW	UP24	5.7.17	65.87817	7.35602	UW	1400	In vial in freezer	397
UW	UP26	6.7.17	66.37419	7.92718	UW	510	In vial in freezer	986
UW	UP28	6.7.17	68.18469	10.21356	UW	710	In vial in freezer	1102
UW	UP30	6.7.17	68.45476	10.99565	UW	800	In vial in freezer	1602
UW	UP32	6.7.17	68.63016	11.52661	UW	1100	In vial in freezer	1991
UW	UP33	6.7.17	68.63016	11.52661	UW	1100	In vial in freezer	1991
6	UP24	8.7.17	71.69998	19.66598	B2	911	In vial in freezer	256
6	UP26	8.7.17	71.69998	19.66598	B2	911	In vial in freezer	256
18	UP28	9.7.17	76.36629	16.64909	B4	857	In vial in freezer	469
18	UP30	9.7.17	76.36629	16.64909	B4	857	In vial in freezer	469
32	UP32	10.7.17	75.18323	17.5334	B6	902	In vial in freezer	141
32	UP33	10.7.17	75.18323	17.5334	B6	902	In vial in freezer	141
47	UP24	11.7.17	76.36644	16.66549	B8	907	In vial in freezer	41
47	UP26	11.7.17	76.36644	16.66549	B8	907	In vial in freezer	41
58	UP28	12.7.17	75.99998	13.6667	B10	902	In vial in freezer	2260
58	UP30	12.7.17	75.99998	13.6667	B10	902	In vial in freezer	2260
69	UP32	13.7.17	75.99996	13.66673	B9	846	In vial in freezer	1027
69	UP33	13.7.17	75.99996	13.66673	B9	846	In vial in freezer	1027
78	UP24	14.7.17	76.36613	21.00184	B11	902	In vial in freezer	228
78	UP26	14.7.17	76.36613	21.00184	B11	902	In vial in freezer	228
90	UP28	15.7.17	75.50022	26.0018	B12	856	In vial in freezer	135
90	UP30	15.7.17	75.50022	26.0018	B12	856	In vial in freezer	135
105	UP32	16.7.17	74.46658	30.00033	B13	905	In vial in freezer	355
105	UP33	16.7.17	74.46658	30.00033	B13	905	In vial in freezer	355
147	UP24	19.7.17	78.21435	30.00075	B15	930	In vial in freezer	315
147	UP26	19.7.17	78.21435	30.00075	B15	930	In vial in freezer	315
186	UP28	22.7.17	80.15129	29.91463	B16	945	In vial in freezer	291
186	UP30	22.7.17	80.15129	29.91463	B16	945	In vial in freezer	291
235	UP32	25.7.17	81.40176	29.50352	B17	800	In vial in freezer	300
235	UP33	25.7.17	81.40176	29.50352	B17	800	In vial in freezer	300
247	UP24	26.7.17	81.7266	29.86902	B18	1132	In vial in freezer	1200
247	UP26	26.7.17	81.7266	29.86902	B18	1132	In vial in freezer	1200
296	UP28	30.7.17	76.49942	30.28672	B18	902	In vial in freezer	290

296	UP30	30.7.17	76.49942	30.28672	B14	92	In vial in freezer	290
357	UP32	3.8.17	76.00026	816.96688	B7	934	In vial in freezer	378
357	UP33	3.8.17	76.00026	816.96688	B7	934	In vial in freezer	318
365	UP24	4.8.17	74.36651	18.16664	B5	588	In vial in freezer	118
365	UP26	4.8.17	74.36651	18.16664	B5	855	In vial in freezer	118
374	UP28	5.8.17	72.63316	19.25008	B3	900	In vial in freezer	365
374	UP30	5.8.17	72.63316	19.25008	B3	900	In vial in freezer	365

Results

All samples will be processed when back at the Scottish Marine Association.

References

Clark, K. A. J., Brierley, A. S. and Pond, D. W. (2012) Composition of wax esters is linked to diapause behavior of *Calanus finmarchicus* in a sea loch environment. *Limnol. Oceanogr.*, 57, 65–75.

Campbell, R. W. and Dower, J. F. (2003) Role of lipids in the maintenance of neutral buoyancy by zooplankton. *Mar. Ecol. Prog. Ser.*, 263, 93–99.

Pond, D.W (2012) The physical properties of lipids and their role in controlling the distribution of zooplankton in the oceans. *Journal of plankton research.* 34 6 443-453

Pond, D. W. and Tarling, G. A. (2011) Phase transitions of wax esters adjust buoyancy in diapausing. *Calanoides acutus*. *Limnol. Oceanogr.*, 56, 1310–1318.

Pond, D. W., Tarling, G. A., Ward, P. et al. (2012) Wax ester composition influences the diapause patterns in the copepod *Calanoides acutus*. *Deep-Sea Res. II*, 59–60, 9

7.5 Phytoplankton/microbial ID and community structure

¹ Jo Nunes (PML), ² Claire Widdicombe (PML)

¹ Author, ² Dataset PI

In support of a GW4+ PhD studentship starting in September 2017 (hosted by PML and University of Bristol), seawater samples were collected from all benthic and pelagic stations (B1 – B18). These samples will be analysed for phytoplankton and microbial community structure and used to explore linkages between water column and benthic processes. At each station, water samples were collected from one CTD cast, from 3-4 depths in the euphotic zone and one near-bottom. Additionally, overlaying water from one megacore deployment per station was also sampled for microbial analysis.

For each sampled depth, phytoplankton samples were collected in 2 x 250mL glass amber bottles, one that had been primed with 5mL of Lugol's iodine and one that had been primed with 10mL of buffered formaldehyde. For the microbial ID work, 2L of water was collected from each sampled depth (samples were collected from the same niskin bottles as the phytoplankton samples). Water was collected in 2L bottles, following 3 rinses. Filled bottles were immediately placed in a cool box lined with a black plastic bag. Each 1L of water was filtered through a sterivex filter using a peristaltic pump, in order to obtain two duplicate samples per depth. Sterivexes were then placed back in their individual blister packs, sealed with electric tape, bagged in a 'station bag' and placed in the -80°C freezer. Samples will be returned to PML for further analysis.

Table 7.5.1

Station	Station location	Station depth	Date	Depths sampled	Event number
B1	70° 46' N 20° 00' E	180m	07/08/2017 (CTD) 07/07/2017 (megacore)	5, 10, 27, 182m (CTD) overlying water (megacore)	411 (CTD) 3 (megacore)
B2	71° 42' N 19° 40' E	250m	08/07/2017	5, 10, 25, 250m (CTD) overlying water (megacore)	6 (CTD) 13 (megacore)
B3	72° 38' N 19° 15' E	370m	05/08/2017	3, 6, 12, 25, 360m (CTD) overlying water (megacore)	374 (CTD) 379 (megacore)
B4	73° 22' N 18° 55' E	480	09/07/2017	7, 15, 37, 456m (CTD) overlying water (megacore)	18 (CTD) 26 (megacore)
B5	74° 22' N 18° 10' E	122m	04/08/2017	3, 16, 25, 108m (CTD) NO MEGACORE – too rocky	365 (CTD)
B6	75° 11' N 17° 32' E	145m	10/07/2017	2, 20, 25, 130m (CTD) overlying water (megacore)	32 (CTD) 38 (megacore)
B7	76° 00' N 16° 50' E	325m	03/08/2017 (CTD) 11/07/2017	3, 12, 28, 309m (CTD) overlying water	357 (CTD) 44 (megacore)

			(megacore)	(megacore)	
B8	76° 22' N 16° 40' E	45m	11/07/2017	3, 8, 18, 41m (CTD) NO MEGACORE – too rocky	47 (CTD)
B9	76° 00' N 13° 40' E	1005m	13/07/2017 (CTD) 12/07/2017 (megacore)	10, 15, 25, 1017m (CTD) overlying water (megacore)	68 (CTD) 54 (megacore)
B10	76° 00' N 10° 40' E	2230m	12/07/2017	10, 15, 35, 2249m (CTD) overlying water (megacore)	58 (CTD) 64 (megacore)
B11	76° 22' N 21° 00' E	231m	14/07/2017	3, 15, 27, 222m (CTD) overlying water (megacore)	78 (CTD) 84 (megacore)
B12	75° 30' N 26° 00' E	139m	15/07/2017	3, 12, 15, 129m (CTD) NO MEGACORE – too rocky	90 (CTD)
B13	74° 30' N 30° 00' E	359m	16/07/2017	3, 12, 15, 22, 344m (CTD) overlying water (megacore)	105 (CTD) 101 (megacore)
B14	76° 30' N 30° 30' E	290m	30/07/2017	3, 22, 35, 48, 279m (CTD) overlying water (megacore)	296 (CTD) 292 (megacore)
B15	78° 15' N 30° 01' E	316m	19/07/2017	3, 8, 15, 34, 319m (CTD) overlying water (megacore)	147 (CTD) 144 (megacore)
B16	80° 06' N 30° 06' E	290m	22/07/2017 (CTD) 21/07/2017 (megacore)	3, 12, 15, 25, 278m (CTD) overlying water (megacore)	186 (CTD) 183 (megacore)
B17	81° 18' N 29° 10' E	310m	25/07/2017 (CTD) 24/07/2017 (megacore)	3, 8, 17, 25, 281m (CTD) overlying water (megacore)	235 (CTD) 223 (megacore)
B18	81° 43' N 29° 52' E	3060m	26/07/2017	10, 45, 60, 2760m (CTD) overlying water (megacore)	248 (CTD) 251 (megacore)

8. Zooplankton community

8.1 Total zooplankton community and lipid content

¹ Sarah Reed (SAMS), ² David Pond (SAMS)

¹Author, ² Dataset PI

DIAPOD

Background and objectives

The DIAPOD project is run by the Scottish Marine Association and is part of the NERC Changing Arctic Ocean Research Programme. *Calanus* copepods seasonally migrate into deeper waters to save energy and reduce their losses to predation in an overwintering process called diapause. The aim of DIAPOD is to understand, predict and model this biological reaction. We wish to understand what changes will happen if the Arctic sea ice keeps retreating at the same rate it is now. By analysing the *Calanus* lipid content predications can be made of how *Calanus* will cope with the change in the timing, magnitude and spatial distribution of diatom productivity in the Arctic Ocean.

Sampling and methods

Midday and midnight comparative vertical tows up from 200 m using a 200 micron bongo net with a 200 micron codend mesh. Two hauls at both midday and midnight were conducted.

Haul 1

The codend was concentrated into a 250 ml Nalgene bottle and preserved in formaldehyde for (a) lipid analysis and (b) determination of community structure. Analysis will take place at SAMS. This will help the DIAPOD project understand the importance of the lipids and fatty acids of the *Calanus* copepod for the lipid based foodweb of the Arctic.

Haul 2

During the second vertical net tow a subsample of 1/3 of the concentrated codend was taken for the ARISE project (see Section 8.2). A subsample for bacterial analysis at PML was also taken and frozen at -80°C.

Data quality notes/ problems

There were no significant sample collection or data quality issues to note.

Samples collected

Table 8.1.1: DIAPOD zooplankton nets

Cruise number	Event number (JCR)	Sample number (ZP)	Date	Latitude (Ship log)	Longitude (ship Log)	Station no.	Time UTC	Depth (m)	Depth of vertical net tow
JR16006	9	3	8.7.17	71.69996	19.66599	B2	1045	256	200
JR16006	16	4	8.7.17	71.70018	19.66658	B2	2057	254	200
JR16006	20	5	9.7.17	73.36781	18.91804	B4	1021	469	200
JR16006	30	8	9.7.17	73.36846	18.92088	B4	2100	470	200
JR16006	34	11	10.7.17	75.18323	17.53334	B6	943	130	120
JR16006	41	13	10.7.17	75.18347	17.53719	B6	2100	130	120
JR16006	48	15	11.7.17	76.36622	16.6493	B8	947	41	30
JR16006	59	17	12.7.17	76.00014	10.66701	B10	1034	2260	200
JR16006	65	19	12.7.17	76.00032	10.66777	B10	2100	2260	200
JR16006	70	21	13.7.17	75.99995	13.66674	B9	954	1027	200
JR16006	76	24	13.7.17	76.00013	13.66665	B9	2200	1027	200
JR16006	79	26	14.7.17	76.36612	21.0018	B11	945	228	200
JR16006	88	28	14.7.17	76.36616	21.00077	B11	2101	227	200
JR16006	91	30	15.7.17	75.50025	26.00173	B12	741	135	120
JR16006	96	32	15.7.17	74.49998	30.00007	B13	2230	359	200
JR16006	106	34	16.7.17	74.46658	30.00051	B13	950	355	200
JR16006	140	36	18.7.17	78.25003	30.00008	B15	2056	315	200
JR16006	148	38	19.7.17	78.21433	30.00088	B15	1015	330	200
JR16006	181	40	21.7.17	80.11911	30.05048	B16	2058	286	200
JR16006	187	42	22.7.17	80.11911	30.05048	B16	841	291	200
JR16006	231	44	24.7.17	81.40989	29.28219	B17	2101	290	200
JR16006	236	46	25.7.17	81.40492	29.55163	B17	841	300	200
JR16006	249	48	26.7.17	81.77251	30.21139	B18	1216	2798	200
JR16006	297	50	30.7.17	76.49942	30.28668	B14	940	290	200
JR16006	308	52	30.7.17	76.49955	30.42335	B14	2144	292	200
JR16006	355	54	2.8.17	76.13348	16.96669	B7	2055	319	200
JR16006	358	57	3.8.17	76.01359	16.8336	B7	952	319	200
JR16006	366	57	4.8.17	74.36651	18.1666	B5	927	118	90
JR16006	371	58	4.8.17	74.36704	18.1673	B5	2050	118	90
JR16006	375	60	5.8.17	72.63173	19.26101	B3	940	366	200
JR16006	383	62	5.8.17	72.64996	19.25122	B3	2120	369	200

Table 8.1.2: Arise net subsamples for PML for bacterial analysis

Cruise number	JR16006 Event number	Sample number	Station no.	Date	Time in (UTC)	Latitude	Longitude	Net mesh size	Depth of water	Depth of vertical tow
JR16006	8	2	B2	8.7.17	1015	71.69996	19.66599	200	256	200
JR16006	17	5	B2	8.7.17	2123	71.70019	19.66662	200	254	200
JR16006	19	6	B4	9.7.17	957	73.36781	18.918	200	469	200
JR16006	31	9	B4	9.7.17	2129	73.36846	18.92085	200	470	200
JR16006	35	12	B6	10.7.17	1010	75.18347	17.53719	200	130	120
JR16006	42	14	B6	10.7.17	2117	75.18348	17.53721	200	130	120
JR16006	49	16	B8	11.7.17	955	76.36629	16.64909	200	41	30
JR16006	60	18	B10	12.7.17	1102	76.00014	10.66697	200	2260	200
JR16006	66	20	B10	12.7.17	2124	76.00033	10.6678	200	2260	200
JR16006	77	55	B9	13.7.17	922	75.99998	13.6667	200	1027	200
JR16006	72	23	B9	13.7.17	1024	75.99994	13.66677	200	1027	200
JR16006	80	27	B11	14.7.17	1011	76.36419	21.00198	200	228	200
JR16006	89	29	B11	14.7.17	2125	76.36432	21.00079	200	227	200
JR16006	92	31	B12	15.7.17	759	75.49813	26.00666	200	135	120
JR16006	97	33	B13	15.7.17	2256	74.49999	30.00009	200	359	200
JR16006	107	35	B13	16.7.17	101	74.46659	30.00048	200	355	200
JR16006	141	37	B15	18.7.17	2124	78.21435	30.00075	200	315	200
JR16006	149	39	B15	19.7.17	1030	78.21433	30.00094	200	330	200
JR16006	182	41	B16	21.7.17	2123	80.11911	30.05048	200	286	200
JR16006	188	43	B16	22.7.17	907	80.16349	29.95601	200	291	200
JR16006	232	44	B17	24.7.17	2132	81.41074	29.31342	200	290	200
JR16006	237	47	B17	25.7.17	901	81.40566	29.57471	200	300	200
JR16006	253	49	B18	26.7.17	2212	81.77251	30.21139	200	2798	200
JR16006	298	51	B14	30.7.17	958	76.4994	30.28671	200	290	200
JR16006	309	53	B14	30.7.17	2214	76.49957	30.42332	200	292	200
JR16006	356	55	B7	2.8.17	2125	76.14682	16.8333	200	319	200
JR16006	359	57	B7	3.8.17	952	76.01359	16.8336	200	319	200
JR16006	367	58	B5	4.8.17	941	74.3665	18.16662	200	118	90
JR16006	372	59	B5	4.8.17	2125	74.37219	18.17614	200	118	90
JR16006	376	61	B3	5.8.17	1002	72.63318	19.25008	200	366	200
JR16006	384	63	B3	5.8.17	2120	72.65179	19.25273	200	366	200

Results

All analysis of the samples will be completed at the Scottish Marine Association. From general observations of the nets it was evident that the abundance and also size of *Calanus* copepods increased further North up the Barents Sea.

Photos

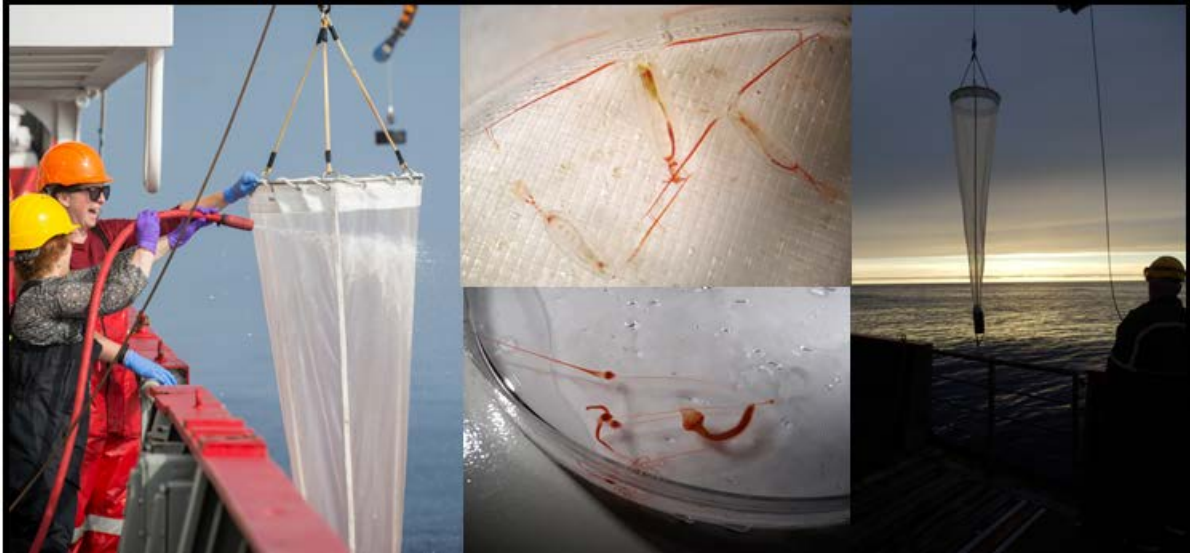

References

Clark, K. A. J., Brierley, A. S. and Pond, D. W. (2012) Composition of wax esters is linked to diapause behavior of *Calanus finmarchicus* in a sea loch environment. *Limnol. Oceanogr.*, 57, 65–75.

Campbell, R. W. and Dower, J. F. (2003) Role of lipids in the maintenance of neutral buoyancy by zooplankton. *Mar. Ecol. Prog. Ser.*, 263, 93–99.

Pond, D.W (2012) The physical properties of lipids and their role in controlling the distribution of zooplankton in the oceans. *Journal of plankton research*. 34 6 443-453

Pond, D. W. and Tarling, G. A. (2011) Phase transitions of wax esters adjust buoyancy in diapausing. *Calanoides acutus*. *Limnol. Oceanogr.*, 56, 1310–1318.

Pond, D. W., Tarling, G. A., Ward, P. et al. (2012) Wax ester composition influences the diapause patterns in the copepod. *Calanoides acutus*. *Deep-Sea Res. II*, 59–60, 93–104.

8.2 ^{15}N and ^{15}N -AA in *Calanus* copepods

¹ Louisa Norman (UoL), ² Rachel Jefferys (UoL)

¹Author, ² Dataset PI

ARISE

Background and objectives

Due to unprecedented rates of environmental change, the Arctic is now a crucible of multiple concurrent stressors. Understanding how food webs are being reshaped over different spatial and temporal scales in response to these stressors is crucial in addressing the impacts of future change on biodiversity and ecosystem services. The ARISE project focuses specifically on the base of the food web and two species of pelagic-feeding ice-dependent predators, the harp seal (*Pagophilus groenlandicus*) and the ringed seal (*Phoca hispida*), which are excellent 'indicator species' of food web functioning.

The stable isotopes of nitrogen (^{14}N , ^{15}N) and carbon (^{12}C , ^{13}C) have the potential to be important food web tracers due to the isotopic discrimination in ^{15}N by ~ 2.5 per mil (‰) and ^{13}C by < 1 ‰ with each trophic transfer. This approach provides quantitative information on the seal trophic position and food chain length. However, the isotopic signal recorded by seals is sensitive to the ^{15}N and ^{13}C at the base of the food web, termed the isoscape. The isoscape is set by the ^{15}N and ^{13}C and magnitude of the nutrient and carbon sources as well as isotope fractionation during N and C assimilation. Seasonal changes in the productivity would drive large shifts in the isoscape owing to changes in available nutrients and associated isotope fractionation. However, POM consists of a mixture of phytoplankton, heterotrophs and detritus and thus using POM to represent the base of the food web may potentially be problematic in food web studies. Operationally, it is not possible to separate the components of POM in order to characterise the ^{15}N and ^{13}C of primary producers specifically. To overcome this a comparison of ^{15}N -POM and ^{15}N -AA in POM (see section 5), specifically the baseline amino acid, phenylalanine, and determination of the sensitivity of the ^{15}N and ^{15}N -AA in zooplankton to the ^{15}N and ^{15}N -AA of POM will be conducted at the University of Liverpool. To this end, copepods of the genus *Calanus* were collected from pelagic stations B1 – B2 and B18, and benthic stations B13 to B17. *Calanus* copepods were selected as they are the most abundant zooplankton present and are, thus, representative of this position in the Arctic food web.

Sampling strategy/instrument description

Midday and midnight vertical tows up from 200 m, or from 20 m above the bottom at depths < 200 m, using a 200 μm ring net with a 200 μm cod end mesh were undertaken at each station, except for B8, B12, B18 and B1 where, due to logistical reasons, there was no night net. The day nets were deployed between the CTD and SAPS sampling to allow for comparison with the ^{15}N , and ^{15}N -AA measurements from the POM samples. Night nets were also sampled as this is when *Calanus* are generally feeding and, thus, the isotopic signatures may vary between day and night depending on whether the individuals had full or empty guts.

Methods

Upon recovery, the net was rinsed with seawater to wash anything adhering to the net into the cod end. The contents of cod end then were placed in a mill-q rinsed bucket and fresh seawater added from the underway system to dilute the sample. Sub-samples were taken from the bucket and placed in a dish with a 500 μm mesh bottom contained in a petri dish with small amount of seawater. The sub-sample was placed under a compound microscope and stage 5 and adult copepods of the genus *Calanus* were picked using fine 'live insect' forceps and placed in 1.5 mL cryovials. Samples were stored at -80°C . Three replicate samples were taken from each net haul. Descriptions of the copepods picked were made (size, full or empty gut, colour etc.) as well as a general description of the contents of the haul.

Data quality notes/ problems

There was very low abundance in the day net hauls at stations B12 and B5 and so fewer individuals than the recommended 100 (3 replicates) were picked. Sticky organic material was prevalent at stations B5, B6, and B7 which required the copepods to be rinsed in clean seawater prior to sampling to mitigate against results being skewed due to the analysis of material adhering to the copepods.

Otherwise no issues.

Table 8.2.1: ARISE zooplankton nets

Event	Net Number	Station number	Latitude	Longitude	Date	Time (UTC)	Depth (m)	Haul depth (m)	Number of copepods picked
9	3	B2	71.69996	19.66604	08/07/2017	10:45	256	200	3 × 100
16	4	B2	71.70018	19.66659	08/07/2017	20:57	254	200	3 × 100
20	7	B4	73.36781	18.91803	09/07/2017	10:21	469	200	3 × 100
30	8	B4	73.36846	18.92088	09/07/2017	21:00	470	200	3 × 100
34	11	B6	75.18323	17.53334	10/07/2017	09:43	141	130	3 × 100
41	13	B6	75.18348	17.5372	10/07/2017	20:59	142	120	3 × 100
48	15	B8	76.36589	16.65599	11/07/2017	09:46	41	30	3 × 100
59	17	B10	76.00014	10.66702	12/07/2017	10:33	2259	200	3 × 100
65	19	B10	76.00032	10.66777	12/07/2017	21:00	2260	200	3 × 100
70	21	B9	75.99996	13.66676	13/07/2017	09:55	1028	200	3 × 100
76	23	B9	76.00013	13.66665	13/07/2017	21:00	1028	200	3 × 100
79	26	B11	76.36612	21.0018	14/07/2017	09:45	227	200	3 × 100
88	28	B11	76.36616	21.00077	14/07/2017	21:01	226.5	200	3 × 100
91	30	B12	75.50025	26.00173	15/07/2017	07:47	135	120	3 × 30
96	32	B13	74.49999	30.00002	15/07/2017	22:30	359	200	3 × 100
106	34	B13	74.46658	30.00051	16/07/2017	09:50	355	200	3 × 100
140	36	B15	78.25003	30.00008	18/07/2017	20:56	315	200	3 × 100
148	38	B15	78.21433	30.0009	19/07/2017	10:15	330	200	3 × 100
181	40	B16	80.11791	30.0357	21/07/2017	20:58	286	200	3 × 100; 3 × 20 Large individuals
187	42	B16	80.16026	29.93854	22/07/2017	08:41	290	200	3 × 100; 3 × 20 Large individuals
231	44	B17	81.40979	29.28084	24/07/2017	21:01	289	200	3 × 100; 3 × 20 Large individuals
236	46	B17	81.40473	29.55042	25/07/2017	08:41	281	200	3 × 100; 3 × 15 Large individuals
249	48	B18	81.73398	29.85354	26/07/2017	12:16	2798	200	3 × 50 Large individuals
297	50	B14	76.49941	30.28704	30/07/2017	09:40	290	200	3 × 100
308	52	B14	76.49958	30.42373	30/07/2017	21:56	292	200	3 × 100

355	54	B7	76.00015	16.83291	02/08/2017	20:55	319	200	3 × 100
358	56	B7	76.00013	16.83364	03/08/2017	09:34	315	200	3 × 100
366	58	B5	74.36644	18.16632	04/08/2017	09:27	118	90	3 × 70
371	60	B5	74.36696	18.16732	04/08/2017	20:57	118	90	3 × 100
375	62	B3	72.63309	19.25027	05/08/2017	09:40	366	200	3 × 100
383	64	B3	72.64986	19.25121	05/08/2017	20:56	369	200	3 × 100
412	66	B1	70.76665	19.998	07/08/2017	08:32	190	170	3 × 100

Results

Analysis of ^{15}N and $^{15}\text{N-AA}$ in zooplankton (*Calanus* copepods) will be conducted at the home laboratory, University of Liverpool.

Observations of each net indicated that at stations south of the ice edge (B1 to B13) *Calanus finmarchicus* and *Calanus glacialis* appeared to be the most abundant copepods present (Fig. 1 A). From B15 to B18 larger individuals, likely *Calanus hyperboreus*, were present in increasing numbers as the transect preceded northwards (Fig. 1 B-D). At B18 only the large individuals were present and the sample was devoid of *C. finmarchicus/glacialis*. Generally, abundance was greater in the midnight net hauls than the midday nets, except at station B3 where the trend was reversed. The hauls from stations south of the ice edge contained more organic material than those to the north, particularly station B5 to B7 where the contents of the cod end were sticky and had to be rinsed in clean seawater prior to picking. This organic material contained a high proportion of flocculated algal material that may include *Phaeocystis* spp. and *Chaetoceros socialis*. Other zooplankton observed regularly in the net hauls included, pteropods (inc. *Clione*), Chaetognaths, mysids, hyperiids, ctenophores and medusa.

Copepods.

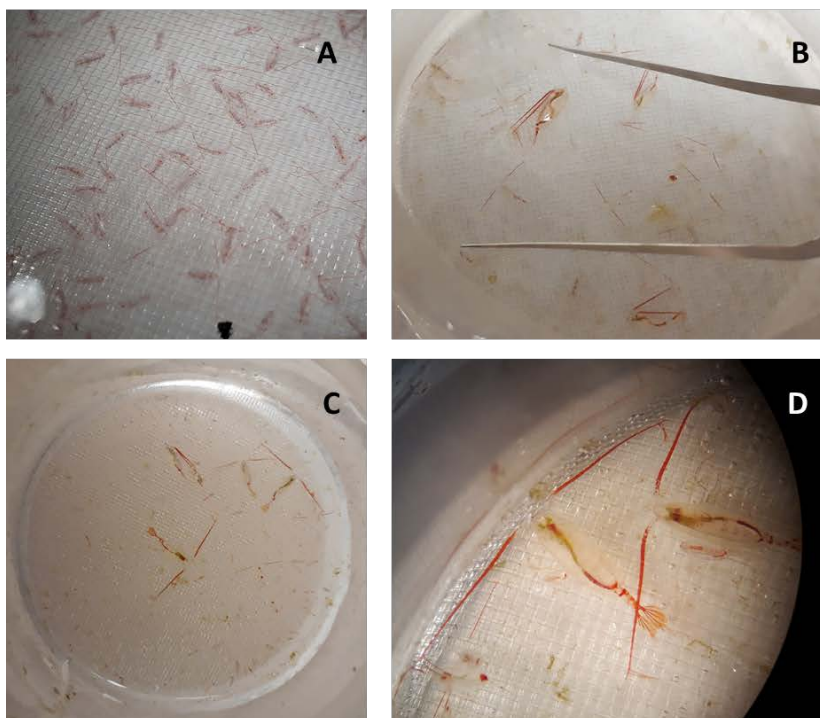

Figure 1. *Calanus* copepods from midday/midnight zoonets
A) *C. finmarchicus/glacialis*, Stn B3
B) *C. finmarchicus/glacialis* & *C. hyperboreus*, Stn B16
C) *C. finmarchicus/glacialis* & *C. hyperboreus*, Stn B16
D) *C. hyperboreus*, Stn B16

Organic material

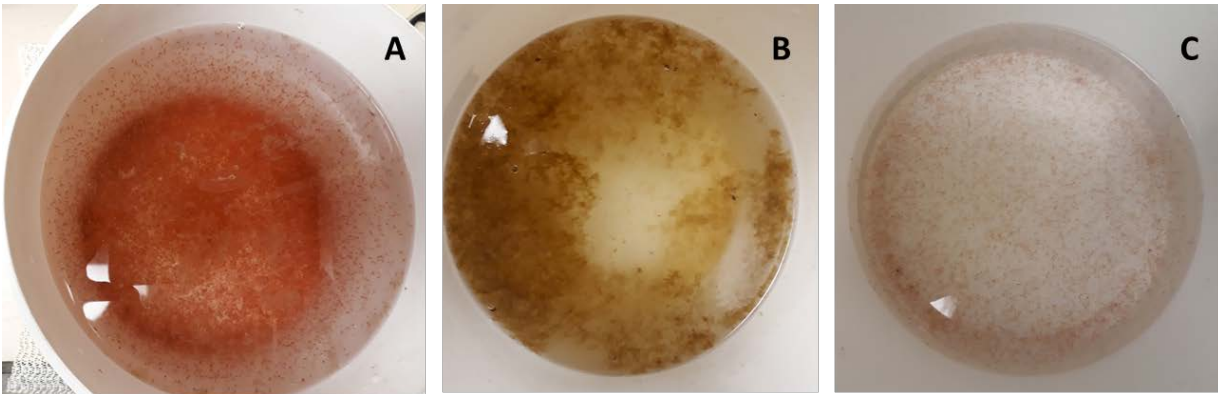

Figure 2. Net hauls from Stns B4 (A), B7 (B) and B8 (C). Stn B7 contained a considerable amount of organic material.

Other zooplankton

Pteropods and Hyperiids

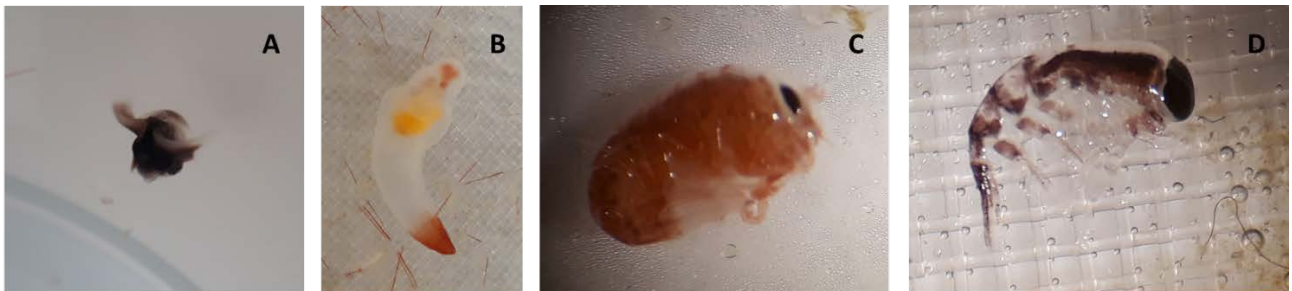

Figure 3. Pictures A & B, Pteropods (B – Clione); Pictures C & D, Hyperiids.

Jellies (Medusa, Ctenophores etc).



Figure 4. Medusa, Ctenophores

9. Sediment and porewater geochemistry

9.1 Organic and inorganic geochemistry

^{1,2}C. März (University of Leeds), ¹D.K.A. Barnes (British Antarctic Survey), ¹T. Brand (Scottish Association of Marine Sciences), ¹J. Faust (University of Leeds), ¹L. Grange (University of Southampton), ¹S. Henley (University of Edinburgh), ¹J. Nunes (Plymouth Marine Laboratory) ¹M. Stevenson (Newcastle University), ¹A. Tessin (University of Leeds), ¹S. Widdicombe (Plymouth Marine Laboratory), ¹D. Wolgemuth (University of Southampton), ³G. Wolff (University of Liverpool), ³B. van Dongen (University of Manchester)

¹Author, ChAOS, ² Dataset PI, ChAOS, ³ Dataset PI, ARISE

Background and objectives

Samples for sediment and pore water geochemistry were taken to study the amounts and types of organic material at the seafloor of the Barents Sea, the availability of electron acceptors (e.g., nitrate, Fe/Mn oxides, sulphate) for organic matter degradation, the recycling versus burial of nutrients released by organic matter degradation, and the interactions of sediment and pore water geochemistry with biological processes (e.g., bioturbation, microbial community structures).

Sampling strategy/instrument description

Sampling sites for the ChAOS project were selected based on available sediment distribution maps of the Barents Sea, with the aim to sample settings with mainly muddy sediment for optimal recovery. In the Barents Sea, muddy sediments are prevalent within the deeper (~300-500 m) troughs carved by ice streams of the Eurasian ice sheet following the Last Glacial Maximum, while the shallower banks are often covered by coarse-grained material due to stronger currents. For the ARISE project, sediment sampling was planned to be conducted at the stations defined by pelagic research objectives (distribution of certain water masses), without taking into account the seafloor topography. Sampling was conducted for the ChAOS project at stations B13 to B18 as well as B3, and additionally for the ARISE project at stations B1 to B4, B6, B7, B9, B11 and B12.



Figure 9.1.1. Deployment of megacorer with 4 tubes

Sampling for sediment and pore water geochemistry was conducted with the Megacorer (a multicoring device with up to 12 core tubes) (Fig. 9.1.1), which is the most appropriate instrument to sample the top ~30-40 cm of sediment with the overlying bottom water and an intact sediment-water interface (Figs. 9.1.2, 9.1.3). The Megacorer and accessories (110 mm wide Perspex tubes, rubber bungs, core extruder etc) were provided by National Marine Facilities.

Prior to deployment, the Megacorer was set up (4 tubes at the ARISE stations; 8 tubes at the ChAOS stations, of which 4-5 were pre-drilled) and was deployed at least 3 times at each station, with ~20 m distance between individual deployments to account for spatial

variability. The actual number of deployments at each station was dependent on the recovery of intact sediment cores. At the ARISE stations, one intact core for sediment sampling per deployment was sufficient. At the ChAOS stations, 2-3 intact cores for pore water sampling and 2-3 intact cores for sediment sampling were required per deployment. At most stations, 3 deployments were sufficient to reach this aim.

Before each Megacorer deployment, the suitability of the seafloor for Megacoring (fine-grained sediment for good recovery, lack of rocks to avoid damage to the tubes) was assessed by deploying a Day Grab (stations B1 to B7), but this practice was abandoned due to issues with the depth control of the bow winch. Instead, the Shallow Underwater Camera System (SUCS) was deployed at each station to provide a visual image of the seafloor. The latter approach was very useful, and allowed us to identify three ARISE stations (B5, B7, B12) unsuitable for Megacoring due to a very rocky seafloor.

Following deployment, the Megacorer was lowered onto the deck, in some cases preceded by manual closing of the bottom shutters (usually without significant loss of sediment). The recovered tubes were labelled by event number and position within the Megacorer. Before removal of the tubes (to avoid re-suspension of sediment into the bottom waters), ~2 L of bottom water was taken by J. Nuñez at each ChAOS station for incubation experiments using a rubber tube. Individual tubes were removed from the Megacorer by 1-2 ChAOS team members each, and transferred into a rack to be carried to the wet lab for further processing.



Figure 9.1.2. Intact sediment-water interface with benthic fauna in a Megacorer tube



Figure 9.1.3. Sediment-filled tubes after successful Megacorer deployment, with cut sponge in the left tube

Methods/Processing/Calibrations

At each of the ARISE stations, two tubes of each of the three Megacorer deployments were sampled, one for organic and one for inorganic geochemistry, at a depth resolution of 0.5 cm between 0 and 2 cm depth, at 1 cm resolution between 2 and 10 cm depth, and (inorganic geochemistry tube only) at 2 cm resolution between 10 cm and the bottom of the tube. Bottom water was removed from the core tubes using a plastic tube. The core tubes were then transferred onto a core extruder (on the back deck for inorganic geochemistry, in the wet lab for organic geochemistry), carefully removing the rubber bung to avoid sediment loss. The sediment was manually pushed up on the extruder, and sampling intervals were defined by 0.5 cm and 1 cm wide Perspex rings (cut from a spare Megacorer tube) being placed on top of the core tube (Fig. 9.1.4). Organic geochemistry samples were taken with stainless steel plates (wearing nitrile gloves to avoid



Figure 9.1.4. Sectioning of sediment in the wetlab for organic geochemistry samples

contamination), transferred into aluminium foil-lined plastic petri dishes, and stored at -80°C . Inorganic geochemistry samples were taken with Perspex plates, transferred into plastic bags, and stored at -20°C .

At each of the ChAOS stations, five to six tubes of each of the three Megacorer deployments were sampled: Two to three for pore waters, one for pigments, one for organic geochemistry+DNA, and one for inorganic geochemistry.

Sampling resolution for the different sample sets was as follows:

Pore waters – bottom water, 0.5 cm, 1.5 cm, 2.5 cm; 2 cm resolution down to 20.5 cm; 25.5 cm, 30.5 cm.

Pigments: Top 0.5 cm only.

Organic geochemistry+DNA and inorganic geochemistry: 0.5 cm resolution from 0 to 2 cm; 1 cm resolution below 2 cm.

Sediment sampling and storage for inorganic geochemistry was carried out in the same manner as at the ARISE stations. For organic geochemistry, samples were sliced in the same manner as at the ARISE stations, but transferred onto pre-

ashed aluminium foil sheets, wrapped, stored in LDPE plastic bags, and transferred into the -80°C freezer following sampling of one complete core tube. DNA samples were taken from the same sediment slices as organic geochemistry samples (except at B13 where samples were taken for two cores from the inorganic core), but using either sterile or ethanol-washed plastic spatulas to transfer the sediment into sterile plastic vials. To avoid contamination the work area was regularly sprayed with ethanol and nitrile gloves were worn. DNA samples were transferred to the -80°C freezer as quickly as possible after sampling (usually 10 minutes in the wet lab at around 10°C). Pigment samples were taken with Perspex or aluminium plates, wrapped in pre-ashed aluminium foil, stored in plastic bags, and transferred into the -80°C freezer.

For pore water sampling, pre-drilled cores were transferred into the sinks in the wet lab, and fixed with bungee cords. Pore water samples were taken with rhizon samplers attached to 50 mL plastic syringes with spacers to keep the vacuum during sampling. At the appropriate depths, the tape was perforated using a pipette tip, and rhizons were inserted quickly and carefully. If rhizons could not be inserted into certain sediment horizons without force (due to the occurrence of rocks), these intervals were not sampled. Syringes were rested onto lab drying racks in the sinks to keep them roughly horizontal. The pore water sampling order was as follows: Bottom water samples were extracted first ($\sim 500\text{ mL}$). While bottom water was being extracted, the Cellotape was perforated at the appropriate depths from the deepest horizon to 4.5 cm depth, rhizons were inserted, and syringes were attached. Once sufficient bottom water had been sampled, the remaining overlying water was drained by perforating the holes right above the

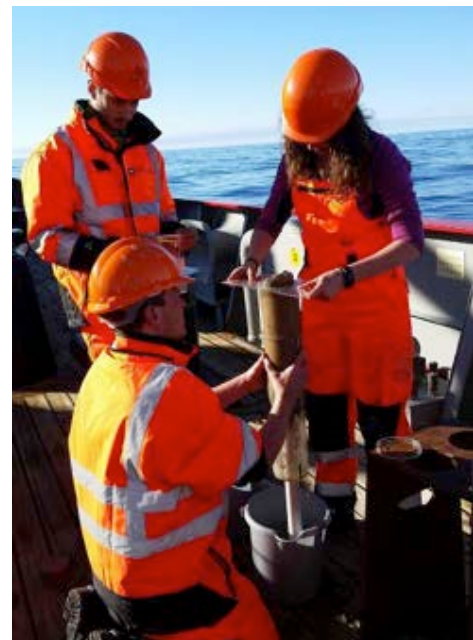

Figure 9.1.5. Sediment sampling on deck for inorganic geochemistry samples

sediment-water interface. Then the holes at 2.5, 1.5 and 0.5 cm depth were opened, and rhizons were inserted very quickly to avoid the loss of pore water from the very water-rich uppermost sediment horizons. Rhizons were left in the core tubes for up to ~2 hours, depending on the efficiency of pore water extraction (very fast in the top layers, much slower in deeper, clay-rich layers). Pore water volumes ranged from 5 to 50 mL per syringe. Following sampling, pore water samples from the two to three core tubes from each Megacorer deployment were combined into acid-washed and MilliQ-rinsed vials to reach maximum pore water volumes for individual sediment layers. From these combined pore water samples, splits were taken for the following analyses: Nutrient analysis (Brand, Henley) – 5-7 mL (higher volumes after partial failure of the autoanalyser); dissolved metal analysis (Faust, März, Tessin) – 3 mL; cation/anion analysis (Faust, März, Tessin) – 1-2 mL; Si isotope analysis (Hendry) – 5 mL; N and O isotope analysis of nitrate (Henley) – 20-25 mL (if available).

Samples for dissolved metal and Si isotope analysis were acidified with 20 μ L of ultrapure concentrated HCl and stored at 4° C. Samples for nutrient analysis were stored untreated for 1 day (3 days in one case) at 4° C prior to shipboard analysis (silicate, phosphate, nitrite, nitrate+nitrite, ammonium). Samples for cation/anion analysis were stored untreated at 4° C. Samples for nitrate isotope analysis were flash-frozen untreated at -80° C, then transferred to -20° C for storage within ~ 24 hours. Equivalent splits were also taken from bottom water samples and treated and stored in the same way as for pore waters.



Figure 9.1.6. Pore water extraction with rhizon samplers and 50 mL syringes in the sink of the wetlab

Data quality notes/ problems

Instrument and material problems: The 12 pre-drilled tubes for pore water sampling had to be modified by members of the ChAOS team onboard, as the holes to insert the rhizon samplers into the tubes only covered the middle part of the tubes. The pre-drilled tubes were therefore drilled again using a manual drill with a 3.5 mm steel bit over the whole length of the tubes, with a depth resolution of 1 cm. Prior to deployment, the drillholes were sealed with a single layer of transparent tape.

The rubber bungs to seal the openings of the core tubes were very difficult to insert into the tubes during the first Megacorer deployment, as the edges of the bungs caught the extremely sharp edges of the core tubes. The bungs were therefore modified: The edges at the narrow ends were smoothed to make them slide into the basal openings of the tubes more easily.

Before and throughout the expedition, the transparent rings holding the tubes in place during the Megacorer deployment needed to be re-glued as they were coming loose (which, in one case, led to the loss of a tube at the seafloor).

The 50 mL syringes used for pore water extraction were, in some cases, unable to hold the vacuum required to draw pore water out of the sediment. For these intervals, the available pore water amounts are less than expected.

Unsuitable sediment for Megacorer deployment: At three of the shallowest ARISE stations (B5, B8, B11), deployment of the SUCS revealed that the seafloor was covered in gravel and boulders, and the Megacorer could not be deployed at these stations.

Data resolution and quality: The pore water sampling strategy was in a few instances compromised by sandy/gravelly layers (up to 5 cm thick) in the core tubes. Rhizones could not be inserted into these horizons, leading to gaps in the pore water sample sets.

At Station B17, brownish precipitates were noticed in the pore water samples below 4.5 cm depth, most likely due to precipitation of dissolved iron as iron (oxyhydr) oxides. These precipitates could have scavenged phosphate from the pore waters, compromising the data quality. This issue will be checked and resolved following analysis of acidified sample splits for total phosphorus at the University of Leeds.

Due to failed syringes and/or sediment characteristics, the amounts of pore water were not uniform, and in some intervals were not sufficient to provide sufficient volume for all planned analyses. This is particularly the case for pore water splits for nitrite concentration and nitrate isotope analyses.

Samples collected

Station	Event	Latitude	Longitude	Water depth (m)
B1	E3	70° 45.998 N	20° 00.030 E	192
Tube #				
Samples taken				
Sediment samples (22 cm; n=15) for organic geochemistry for M. Stevenson, G. Abbott (Newcastle) and G. Wolffe (Liverpool)				
Sediment samples (28 cm; n=19) for inorganic geochemistry for C. März (Leeds)				
Sterivex samples of overlying water for (PML)				

Station	Event	Latitude	Longitude	Water depth (m)
B1	E4	70° 45.997 N	20° 00.029 E	192
Tube #				
Samples taken				
Sediment samples (22 cm; n=15) for organic geochemistry for M. Stevenson, G. Abbott (Newcastle) and G. Wolffe (Liverpool)				

Station	Event	Latitude	Longitude	Water depth
B1	E5	70° 45.998 N	20° 00.030 E	192 (m)
Tube #				
Samples taken				
Sediment samples (22 cm; n=15) for organic geochemistry for M. Stevenson, G. Abbott (Newcastle) and G. Wolffe (Liverpool)				

Station	Event	Latitude	Longitude	Water depth
B2	E13	71° 42.000 N	19° 39.960 E	256 (m)

Tube #	Samples taken
11	Sediment samples (10 cm; n=10) for organic geochemistry for M. Stevenson, G. Abbott (Newcastle) and G. Wolffe (Liverpool)
11	Sterivex samples of overlying water for (PML)

Station	Event	Latitude	Longitude	Water depth
B2	E14	71° 42.010 N	19° 39.958 E	254 (m)
Tube #	Samples taken			
5	Sediment samples (39 cm; n=27) for inorganic geochemistry for C. März (Leeds)			
11	Sediment samples (10 cm; n=10) for organic geochemistry for M. Stevenson, G. Abbott (Newcastle) and G. Wolffe (Liverpool)			

Station	Event	Latitude	Longitude	Water depth
B2	E15	71° 42.011 N	19° 39.996 E	254 (m)
Tube #	Samples taken			
11	Sediment samples (10 cm; n=10) for organic geochemistry for M. Stevenson, G. Abbott (Newcastle) and G. Wolffe (Liverpool)			

Station	Event	Latitude	Longitude	Water depth
B3	E379	72° 37.999 N	15° 15.004 E	364 (m)
Tube #	Samples taken			
3,7,9	Pore water samples (30.5 cm; n=15) 1. Nutrient samples (~7 mL)- analyzed shipboard 2. Acidified split for elemental analysis (~3 mL) for C. März (Leeds) 3. Unacidified split for major ion analysis (~1-2 mL) for C. März (Leeds) 4. Nitrate isotope samples (~20 mL) for S. Henley (Edinburgh) 5. Silica isotope samples (~5 mL) for K. Hendry (Bristol)			
1	Sediment samples (35 cm; n=37) for inorganic geochemistry for C. März (Leeds)			
4	Sediment samples (top 0-0.5 cm) for pigment analysis for R. Airs (PML)			
6	Sediment samples (24 cm; n=26) for organic geochemistry for M. Stevenson (Newcastle)			
6	Sediment samples (24 cm; n=26) for DNA analyses for K. Tait (PML) and I. Head (Newcastle)			
	Sterivex samples of overlying water for J. Dixon (PML)			

Station	Event	Latitude	Longitude	Water depth
B3	E281	72° 37.951 N	15° 15.181 E	364 (m)
Tube #	Samples taken			
1, 9, 12	Pore water samples (30.5 cm; n=15) 1. Nutrient samples (~7 mL)- analyzed shipboard 2. Acidified split for elemental analysis (~3 mL) for C. März (Leeds) 3. Unacidified split for major ion analysis (~1-2 mL) for C. März (Leeds) 4. Nitrate isotope samples (~20 mL) for S. Henley (Edinburgh)			

	5. Silica isotope samples (~5 mL) for K. Hendry (Bristol)
7	Sediment samples (25 cm; n=27) for inorganic geochemistry for C. März (Leeds)
10	Sediment samples (top 0-0.5 cm) for pigment analysis for R. Airs (PML)
3	Sediment samples (18 cm; n=20) for organic geochemistry for M. Stevenson & G. Abbott (Newcastle)
3	Sediment samples (18 cm; n=20) for DNA analyses for K. Tait (PML) and I. Head (Newcastle)

Station	Event	Latitude	Longitude	Water depth
B3	E382	72° 37.940 N	15° 14.812 E	368 (m)
Tube #	Samples taken			
3,7,9	Pore water samples (30.5 cm; n=15) 1. Nutrient samples (~7 mL)- analyzed shipboard 2. Acidified split for elemental analysis (~3 mL) for C. März (Leeds) 3. Unacidified split for major ion analysis (~1-2 mL) for C. März (Leeds) 4. Nitrate isotope samples (~20 mL) for S. Henley (Edinburgh) 5. Silica isotope samples (~5 mL) for K. Hendry (Bristol)			
1	Sediment samples (30 cm; n=32) for inorganic geochemistry for C. März (Leeds)			
3	Sediment samples (top 0-0.5 cm) for pigment analysis for R. Airs (PML)			
7	Sediment samples (28 cm; n= 30) for organic geochemistry for M. Stevenson & G. Abbott (Newcastle)			
7	Sediment samples (28 cm; n= 30) for DNA analyses for K. Tait (PML) and I. Head (Newcastle)			

Station	Event	Latitude	Longitude	Water depth
B4	E26	73° 22.095 N	18° 55.232 E	470 (m)
Tube #	Samples taken			
2, 5	Sterivex samples of overlying water for J. Dixon (PML)			
5	Sediment samples (36 cm; n=23) for inorganic geochemistry for C. März (Leeds)			
8	Sediment samples (10 cm; n=10) for organic geochemistry for M. Stevenson, G. Abbott (Newcastle) and G. Wolffe (Liverpool)			

Station	Event	Latitude	Longitude	Water depth
B4	E27	73° 22.306 N	18° 55.236 E	469 (m)
Tube #	Samples taken			
11	Sediment samples (10 cm; n=10) for organic geochemistry for M. Stevenson, G. Abbott (Newcastle) and G. Wolffe (Liverpool)			

Station	Event	Latitude	Longitude	Water depth
B4	E28	73° 22.106 N	18° 55.270 E	470 (m)
Tube #	Samples taken			
5	Sediment samples (10 cm; n=10) for organic geochemistry for M. Stevenson, G.			

	Abbott (Newcastle) and G. Wolffe (Liverpool)
--	--

Station	Event	Latitude	Longitude	Water depth
B6	E38	75° 11.012 N	17° 32.205 E	142 (m)
Tube #	Samples taken			
5	Sterivex samples of overlying water for J. Dixon (PML)			
11	Sediment samples (10 cm; n=10) for organic geochemistry for M. Stevenson, G. Abbott (Newcastle) and G. Wolffe (Liverpool)			

Station	Event	Latitude	Longitude	Water depth
B6	E39	75° 11.012 N	17° 32.204 E	141 (m)
Tube #	Samples taken			
5	Sediment samples (10 cm; n=10) for organic geochemistry for M. Stevenson, G. Abbott (Newcastle) and G. Wolffe (Liverpool)			

Station	Event	Latitude	Longitude	Water depth
B6	E40	75° 11.012 N	17° 32.204 E	141 (m)
Tube #	Samples taken			
2	Sediment samples (10 cm; n=10) for organic geochemistry for M. Stevenson, G. Abbott (Newcastle) and G. Wolffe (Liverpool)			
11	Sediment samples (35 cm; n=23) for inorganic geochemistry for C. März (Leeds)			

Station	Event	Latitude	Longitude	Water depth
B7	E44	76° 00.028 N	16° 83.322 E	319
Tube #	Samples taken			
2	Sediment samples (10 cm; n=10) for organic geochemistry for M. Stevenson, G. Abbott (Newcastle) and G. Wolffe (Liverpool)			
5, 11	Sterivex samples of overlying water for J. Dixon (PML)			
8	Sediment samples (38 cm; n=26) for inorganic geochemistry for C. März (Leeds)			

Station	Event	Latitude	Longitude	Water depth
B7	E45	76° 00.031 N	16° 83.403 E	319
Tube #	Samples taken			
2	Sediment samples (10 cm; n=10) for organic geochemistry for M. Stevenson, G. Abbott (Newcastle) and G. Wolffe (Liverpool)			

Station	Event	Latitude	Longitude	Water depth
B7	E46	76° 00.03 N	16° 83.479 E	318

Tube #	Samples taken
8	Sediment samples (10 cm; n=10) for organic geochemistry for M. Stevenson, G. Abbott (Newcastle) and G. Wolffe (Liverpool)

Station	Event	Latitude	Longitude	Water depth
B9	E54	76° 00.032 N	13° 39.990 E	1029 (m)
Tube #	Samples taken			
2, 8	Sterivex samples of overlying water for J. Dixon (PML)			
2	Sediment samples (9 cm; n=9) for organic geochemistry for M. Stevenson (Newcastle) and G. Wolffe (Liverpool)			

Station	Event	Latitude	Longitude	Water depth
B9	E55	76° 00.043 N	13° 39.991 E	1029 (m)
Tube #	Samples taken			
5	Sediment samples (10 cm; n=10) for organic geochemistry for M. Stevenson, G. Abbott (Newcastle) and G. Wolffe (Liverpool)			
8	Sediment samples (34 cm; n=22) for inorganic geochemistry for C. März (Leeds)			

Station	Event	Latitude	Longitude	Water depth
B9	E56	76° 00.043 N	13° 40.037 E	1028 (m)
Tube #	Samples taken			
5	Sediment samples (10 cm; n=10) for organic geochemistry for M. Stevenson, G. Abbott (Newcastle) and G. Wolffe (Liverpool)			

Station	Event	Latitude	Longitude	Water depth
B10	E62	76° 00.008 N	13° 40.019 E	2261 (m)
Tube #	Samples taken			
11	Sediment samples (10 cm; n=10) for organic geochemistry for M. Stevenson, G. Abbott (Newcastle) and G. Wolffe (Liverpool)			

Station	Event	Latitude	Longitude	Water depth
B10	E63	76° 00.019 N	13° 40.023 E	2260 (m)
Tube #	Samples taken			
2	Sediment samples (10 cm; n=10) for organic geochemistry for M. Stevenson, G. Abbott (Newcastle) and G. Wolffe (Liverpool)			
1	Sediment samples (28 cm; n=19) for inorganic geochemistry for C. März (Leeds)			

Station	Event	Latitude	Longitude	Water depth
B10	E64	76° 00.013 N	13° 40.067 E	2260 (m)
Tube #				
11	Sediment samples (10 cm; n=10) for organic geochemistry for M. Stevenson, G. Abbott (Newcastle) and G. Wolffe (Liverpool)			
2, 8	Sterivex samples of overlying water for J. Dixon (PML)			

Station	Event	Latitude	Longitude	Water depth
B11	E84	76° 21.976 N	20° 59.773 E	228 (m)
Tube #				
2	Sediment samples (10 cm; n=10) for organic geochemistry for M. Stevenson, G. Abbott (Newcastle) and G. Wolffe (Liverpool)			
8	Sediment samples (36 cm; n=23) for inorganic geochemistry for C. März (Leeds)			
11	Sterivex samples of overlying water for J. Dixon (PML)			

Station	Event	Latitude	Longitude	Water depth
B11	E85	76° 21.974 N	20° 59.769 E	228 (m)
Tube #				
5	Sediment samples (10 cm; n=10) for organic geochemistry for M. Stevenson, G. Abbott (Newcastle) and G. Wolffe (Liverpool)			

Station	Event	Latitude	Longitude	Water depth
B11	E86	76° 21.976 N	20° 59.823 E	229 (m)
Tube #				
5	Sediment samples (10 cm; n=10) for organic geochemistry for M. Stevenson, G. Abbott (Newcastle) and G. Wolffe (Liverpool)			

Station	Event	Latitude	Longitude	Water depth
B13	E101	74° 29.998 N	30° 00.009 E	359 (m)
Tube #				
1, 4	Pore water samples (30.5 cm; n=15) 1. Nutrient samples (~7 mL)- analyzed shipboard 2. Acidified split for elemental analysis (~3 mL) for C. März (Leeds) 3. Unacidified split for major ion analysis (~1-2 mL) for C. März (Leeds) 4. Nitrate isotope samples (~20 mL) for S. Henley (Edinburgh) 5. Silica isotope samples (~5 mL) for K. Hendry (Bristol)			
6	Sediment samples (24 cm; n=26) for inorganic geochemistry for C. März (Leeds)			
3	Sediment samples (top 0-0.5 cm) for pigment analysis for R. Airs (PML)			
9	Sediment samples (20 cm; n=22) for organic geochemistry for M. Stevenson and G. Abbott (Newcastle)			
9	Sediment samples (20 cm; n=22) for DNA analyses for K. Tait (PML) and I. Head (Newcastle)			

Sterivex samples of overlying water for J. Dixon (PML)

Station	Event	Latitude	Longitude	Water depth
B13	E102	74° 29.998 N	30° 00.049 E	359 (m)
Tube #	Samples taken			
	Pore water samples (30.5 cm; n=15) <ol style="list-style-type: none"> 1. Nutrient samples (~7 mL)- analyzed shipboard 2. Acidified split for elemental analysis (~3 mL) for C. März (Leeds) 3. Unacidified split for major ion analysis (~1-2 mL) for C. März (Leeds) 4. Nitrate isotope samples (~20 mL) for S. Henley (Edinburgh) 5. Silica isotope samples (~5 mL) for K. Hendry (Bristol) 			
12	Sediment samples (26 cm; n=28) for inorganic geochemistry for C. März (Leeds)			
4	Sediment samples (top 0-0.5 cm) for pigment analysis for R. Airs (PML)			
9	Sediment samples (26 cm; n=28) for organic geochemistry for M. Stevenson and G. Abbott (Newcastle)			
9	Sediment samples (26 cm; n=28) for DNA analyses for K. Tait (PML) and I. Head (Newcastle)			

Station	Event	Latitude	Longitude	Water depth
B13	E104	74° 29.987 N	30° 00.013 E	359 (m)
Tube #	Samples taken			
	Pore water samples (30.5 cm; n=15) <ol style="list-style-type: none"> 1. Nutrient samples (~7 mL)- analyzed shipboard 2. Acidified split for elemental analysis (~3 mL) for C. März (Leeds) 3. Unacidified split for major ion analysis (~1-2 mL) for C. März (Leeds) 4. Nitrate isotope samples (~20 mL) for S. Henley (Edinburgh) 5. Silica isotope samples (~5 mL) for K. Hendry (Bristol) 			
6	Sediment samples (24 cm; n=26) for inorganic geochemistry for C. März (Leeds)			
Box core	Sediment samples (top 0-0.5 cm) for pigment analysis for R. Airs (PML)			
9	Sediment samples (27 cm; n=29) for organic geochemistry for M. Stevenson and G. Abbott (Newcastle)			
9	Sediment samples (27 cm; n=29) for DNA analyses for K. Tait (PML) and I. Head (Newcastle)			

Station	Event	Latitude	Longitude	Water depth
B14	E292	76° 29.943 N	30° 29.844 E	293 (m)
Tube #	Samples taken			
1, 3, 9	Pore water samples (30.5 cm; n=15) <ol style="list-style-type: none"> 1. Nutrient samples (~7 mL)- analyzed shipboard 2. Acidified split for elemental analysis (~3 mL) for C. März (Leeds) 3. Unacidified split for major ion analysis (~1-2 mL) for C. März (Leeds) 4. Nitrate isotope samples (~20 mL) for S. Henley (Edinburgh) 5. Silica isotope samples (~5 mL) for K. Hendry (Bristol) 			
6	Sediment samples (37 cm; n=39) for inorganic geochemistry for C. März (Leeds)			
12	Sediment samples (top 0-0.5 cm) for pigment analysis for R. Airs (PML)			

4	Sediment samples (30 cm; n=32) for organic geochemistry for M. Stevenson and G. Abbott (Newcastle)
4	Sediment samples (30 cm; n=32) for DNA analyses for K. Tait (PML) and I. Head (Newcastle)
4	Sterivex samples of overlying water for J. Dixon (PML)

Station	Event	Latitude	Longitude	Water depth
B14	E294	76° 30.050 N	30° 29.796 E	294 (m)
Tube #	Samples taken			
3, 6, 12	Pore water samples (30.5 cm; n=15) <ol style="list-style-type: none"> 1. Nutrient samples (~7 mL)- analyzed shipboard 2. Acidified split for elemental analysis (~3 mL) for C. März (Leeds) 3. Unacidified split for major ion analysis (~1-2 mL) for C. März (Leeds) 4. Nitrate isotope samples (~20 mL) for S. Henley (Edinburgh) 5. Silica isotope samples (~5 mL) for K. Hendry (Bristol) 			
4	Sediment samples (35 cm; n=37) for inorganic geochemistry for C. März (Leeds)			
9	Sediment samples (top 0-0.5 cm) for pigment analysis for R. Airs (PML)			
1	Sediment samples (30 cm; n=32) for organic geochemistry for M. Stevenson and G. Abbott (Newcastle)			
1	Sediment samples (30 cm; n=32) for DNA analyses for K. Tait (PML) and I. Head (Newcastle)			

Station	Event	Latitude	Longitude	Water depth
B14	E295	76° 30.055 N	30° 30.241d E	293 (m)
Tube #	Samples taken			
6, 9, 12	Pore water samples (30.5 cm; n=15) <ol style="list-style-type: none"> 1. Nutrient samples (~7 mL)- analyzed shipboard 2. Acidified split for elemental analysis (~3 mL) for C. März (Leeds) 3. Unacidified split for major ion analysis (~1-2 mL) for C. März (Leeds) 4. Nitrate isotope samples (~20 mL) for S. Henley (Edinburgh) 5. Silica isotope samples (~5 mL) for K. Hendry (Bristol) 			
4	Sediment samples (33 cm; n=35) for inorganic geochemistry for C. März (Leeds)			
1	Sediment samples (top 0-0.5 cm) for pigment analysis for R. Airs (PML)			
3	Sediment samples (33 cm; n=35) for organic geochemistry for M. Stevenson and G. Abbott (Newcastle)			
3	Sediment samples (33 cm; n=35) for DNA analyses for K. Tait (PML) and I. Head (Newcastle)			

Station	Event	Latitude	Longitude	Water depth
B15	E144	78° 15.100 N	30° 00.540 E	317 (m)
Tube #	Samples taken			
6, 9, 12	Pore water samples (30.5 cm; n=15) <ol style="list-style-type: none"> 1. Nutrient samples (~7 mL)- analyzed shipboard 2. Acidified split for elemental analysis (~3 mL) for C. März (Leeds) 3. Unacidified split for major ion analysis (~1-2 mL) for C. März (Leeds) 			

	4. Nitrate isotope samples (~20 mL) for S. Henley (Edinburgh) 5. Silica isotope samples (~5 mL) for K. Hendry (Bristol)
10	Sediment samples (26 cm; n=28) for inorganic geochemistry for C. März (Leeds)
10	Sediment samples (top 0-0.5 cm) for pigment analysis for R. Airs (PML)
7	Sediment samples (31 cm; n=33) for organic geochemistry for M. Stevenson and G. Abbott (Newcastle)
7	Sediment samples (31 cm; n=33) for DNA analyses for K. Tait (PML) and I. Head (Newcastle)
10	Sterivex samples of overlying water for J. Dixon (PML)

Station	Event	Latitude	Longitude	Water depth
B15	E145	78° 15.090 N	30° 00.544 E	317 (m)
Tube #	Samples taken			
1, 7, 12	Pore water samples (30.5 cm; n=15) 1. Nutrient samples (~7 mL)- analyzed shipboard 2. Acidified split for elemental analysis (~3 mL) for C. März (Leeds) 3. Unacidified split for major ion analysis (~1-2 mL) for C. März (Leeds) 4. Nitrate isotope samples (~20 mL) for S. Henley (Edinburgh) 5. Silica isotope samples (~5 mL) for K. Hendry (Bristol)			
6	Sediment samples (32 cm; n=34) for inorganic geochemistry for C. März (Leeds)			
3	Sediment samples (top 0-0.5 cm) for pigment analysis for R. Airs (PML)			
10	Sediment samples (30 cm; n=32) for organic geochemistry for M. Stevenson and G. Abbott (Newcastle)			
10	Sediment samples (30 cm; n=35) for DNA analyses for K. Tait (PML) and I. Head (Newcastle)			

Station	Event	Latitude	Longitude	Water depth
B15	E146	78° 15.091 N	30° 00.506 E	317 (m)
Tube #	Samples taken			
1, 4	Pore water samples (30.5 cm; n=15) 1. Nutrient samples (~7 mL)- analyzed shipboard 2. Acidified split for elemental analysis (~3 mL) for C. März (Leeds) 3. Unacidified split for major ion analysis (~1-2 mL) for C. März (Leeds) 4. Nitrate isotope samples (~20 mL) for S. Henley (Edinburgh) 5. Silica isotope samples (~5 mL) for K. Hendry (Bristol)			
9	Sediment samples (34 cm; n=36) for inorganic geochemistry for C. März (Leeds)			
3	Sediment samples (top 0-0.5 cm) for pigment analysis for R. Airs (PML)			
6	Sediment samples (32 cm; n=34) for organic geochemistry for M. Stevenson and G. Abbott (Newcastle)			
6	Sediment samples (32 cm; n=34) for DNA analyses for K. Tait (PML) and I. Head (Newcastle)			

Station	Event	Latitude	Longitude	Water depth
B16	E183	80° 07.154 N	30° 04.069 E	283 (m)
Tube #	Samples taken			

4, 9, 10	Pore water samples (30.5 cm; n=15) <ol style="list-style-type: none"> 1. Nutrient samples (~7 mL)- analyzed shipboard 2. Acidified split for elemental analysis (~3 mL) for C. März (Leeds) 3. Unacidified split for major ion analysis (~1-2 mL) for C. März (Leeds) 4. Nitrate isotope samples (~20 mL) for S. Henley (Edinburgh) 5. Silica isotope samples (~5 mL) for K. Hendry (Bristol)
3	Sediment samples (30 cm; n=32) for inorganic geochemistry for C. März (Leeds)
1	Sediment samples (top 0-0.5 cm) for pigment analysis for R. Airs (PML)
6	Sediment samples (27 cm; n=29) for organic geochemistry for M. Stevenson and G. Abbott (Newcastle)
6	Sediment samples (27 cm; n=29) for DNA analyses for K. Tait (PML) and I. Head (Newcastle)
	Sterivex samples of overlying water for J. Dixon (PML)

Station	Event	Latitude	Longitude	Water depth
B16	E184	80° 07.009 N	30° 04.499 E	282 (m)
Tube #	Samples taken			
3, 4, 10	Pore water samples (30.5 cm; n=15) <ol style="list-style-type: none"> 1. Nutrient samples (~7 mL)- analyzed shipboard 2. Acidified split for elemental analysis (~3 mL) for C. März (Leeds) 3. Unacidified split for major ion analysis (~1-2 mL) for C. März (Leeds) 4. Nitrate isotope samples (~20 mL) for S. Henley (Edinburgh) 5. Silica isotope samples (~5 mL) for K. Hendry (Bristol) 			
6	Sediment samples (28 cm; n=30) for inorganic geochemistry for C. März (Leeds)			
12	Sediment samples (top 0-0.5 cm) for pigment analysis for R. Airs (PML)			
1	Sediment samples (23cm; n=25) for organic geochemistry for M. Stevenson and G. Abbott (Newcastle)			
1	Sediment samples (23 cm; n=25) for DNA analyses for K. Tait (PML) and I. Head (Newcastle)			

Station	Event	Latitude	Longitude	Water depth
B16	E185	80° 06.650 N	30° 03.593 E	279 (m)
Tube #	Samples taken			
7, 10, 12	Pore water samples (30.5 cm; n=15) <ol style="list-style-type: none"> 1. Nutrient samples (~7 mL)- analyzed shipboard 2. Acidified split for elemental analysis (~3 mL) for C. März (Leeds) 3. Unacidified split for major ion analysis (~1-2 mL) for C. März (Leeds) 4. Nitrate isotope samples (~20 mL) for S. Henley (Edinburgh) 5. Silica isotope samples (~5 mL) for K. Hendry (Bristol) 			
6	Sediment samples (26 cm; n=28) for inorganic geochemistry for C. März (Leeds)			
4	Sediment samples (top 0-0.5 cm) for pigment analysis for R. Airs (PML)			
9	Sediment samples (22 cm; n=24) for organic geochemistry for M. Stevenson and G. Abbott (Newcastle)			
9	Sediment samples (22 cm; n=24) for DNA analyses for K. Tait (PML) and I. Head (Newcastle)			

Station	Event	Latitude	Longitude	Water depth
B17	E223	81° 17.290 N	30° 20.451 E	336 (m)
Tube #	Samples taken			
1, 4, 9	Pore water samples (30.5 cm; n=15) 1. Nutrient samples (~7 mL)- analyzed shipboard 2. Acidified split for elemental analysis (~3 mL) for C. März (Leeds) 3. Unacidified split for major ion analysis (~1-2 mL) for C. März (Leeds) 4. Nitrate isotope samples (~20 mL) for S. Henley (Edinburgh) 5. Silica isotope samples (~5 mL) for K. Hendry (Bristol)			
7	Sediment samples (34 cm; n=36) for inorganic geochemistry for C. März (Leeds)			
3	Sediment samples (top 0-0.5 cm) for pigment analysis for R. Airs (PML)			
6	Sediment samples (31 cm; n=33) for organic geochemistry for M. Stevenson and G. Abbott (Newcastle)			
6	Sediment samples (31 cm; n=33) for DNA analyses for K. Tait (PML) and I. Head (Newcastle)			
10	Sterivex samples of overlying water for J. Dixon (PML)			

Station	Event	Latitude	Longitude	Water depth
B17	E225	81° 16.991 N	29° 19.957 E	340 (m)
Tube #	Samples taken			
7, 9, 10	Pore water samples (30.5 cm; n=15) 1. Nutrient samples (~7 mL)- analyzed shipboard 2. Acidified split for elemental analysis (~3 mL) for C. März (Leeds) 3. Unacidified split for major ion analysis (~1-2 mL) for C. März (Leeds) 4. Nitrate isotope samples (~20 mL) for S. Henley (Edinburgh) 5. Silica isotope samples (~5 mL) for K. Hendry (Bristol)			
12	Sediment samples (39 cm; n=41) for inorganic geochemistry for C. März (Leeds)			
12	Sediment samples (top 0-0.5 cm) for pigment analysis for R. Airs (PML)			
4	Sediment samples (34 cm; n=36) for organic geochemistry for M. Stevenson and G. Abbott (Newcastle)			
4	Sediment samples (34 cm; n=36) for DNA analyses for K. Tait (PML) and I. Head (Newcastle)			

Station	Event	Latitude	Longitude	Water depth
B17	E226	81° 16.765 N	30° 19.496 E	340 (m)
Tube #	Samples taken			
6, 9, 12	Pore water samples (30.5 cm; n=15) 1. Nutrient samples (~7 mL)- analyzed shipboard 2. Acidified split for elemental analysis (~3 mL) for C. März (Leeds) 3. Unacidified split for major ion analysis (~1-2 mL) for C. März (Leeds) 4. Nitrate isotope samples (~20 mL) for S. Henley (Edinburgh) 5. Silica isotope samples (~5 mL) for K. Hendry (Bristol)			
1	Sediment samples (38 cm; n=40) for inorganic geochemistry for C. März (Leeds)			
3	Sediment samples (top 0-0.5 cm) for pigment analysis for R. Airs (PML)			
4	Sediment samples (34 cm; n=36) for organic geochemistry for M. Stevenson and			

	G. Abbott (Newcastle)
4	Sediment samples (34 cm; n=36) for DNA analyses for K. Tait (PML) and I. Head (Newcastle)

Station	Event	Latitude	Longitude	Water depth
B18	E251	81° 45.498 N	30° 00.870 E	2963 (m)
Tube #	Samples taken			
7, 9	Pore water samples (30.5 cm; n=15) <ol style="list-style-type: none"> 1. Nutrient samples (~7 mL)- analyzed shipboard 2. Acidified split for elemental analysis (~3 mL) for C. März (Leeds) 3. Unacidified split for major ion analysis (~1-2 mL) for C. März (Leeds) 4. Nitrate isotope samples (~20 mL) for S. Henley (Edinburgh) 5. Silica isotope samples (~5 mL) for K. Hendry (Bristol) 			
4	Sediment samples (34 cm; n=36) for inorganic geochemistry for C. März (Leeds)			
10	Sediment samples (top 0-0.5 cm) for pigment analysis for R. Airs (PML)			
6	Sediment samples (33 cm; n=35) for organic geochemistry for M. Stevenson, G. Abbott (Newcastle) and G. Wolffe (Liverpool).			
6	Sediment samples (33 cm; n=35) for DNA analyses for K. Tait (PML) and I. Head (Newcastle)			
	Sterivex samples of overlying water for J. Dixon (PML)			

Station	Event	Latitude	Longitude	Water depth
B18	E252	81° 45.053 N	30° 08.588 E	3038 (m)
Tube #	Samples taken			
4	Sediment samples (36 cm; n=23) for organic geochemistry for M. Stevenson and G. Abbott (Newcastle) and G. Wolffe (Liverpool)			

9.2 Pore water nutrient analysis

¹ Tim Brand (SAMS), ^{1,2} Sian Henley (University of Edinburgh), ¹ Christian März (University of Leeds)

¹ Author, ² Dataset PI
ChAOS

Summary

The macro nutrients, ammonium, phosphate, silicate (reactive silica), total oxidized nitrogen, TON, and nitrite, were analysed in the pore water fluids of sediment cores using a flow injection autoanalyser from sediment cores from 5 core sites Table 9.2.3.

Methods

Samples were collected in 50ml acid cleaned polythene vials from the SMBA multicore Perspex tubes using Rhizone filters for the pore water extraction (See März, Henley for details). All samples were allowed to equilibrate to room temperature for an hour before analysis. Measurement was conducted using a Lachat *QuikChem 8500* flow injection autoanalyser (Hach Lange) using the manufacturers recommended methods: Ammonium, 31-107-06-1-B; Orthophosphate, 31-115-01-1-G; Silicate, 31-114-27-1-A and Nitrate/Nitrite, 31-107-04-1-A. After analysis, the 50ml tubes were double rinsed with the ship's DI water and reused for subsequent sample collection. Tubes that contained samples that generated cloudiness upon sitting prior to being analysed, thought to be due to the precipitation of particulate iron, were acid cleaned with 10% hydrochloric acid before reuse. Samples were diluted 3 parts in 9 to ensure there was sufficient sample for analysis and to ensure concentrations did not exceed the normal operating concentration range of the instrument

Individual stock standard solutions of nitrate, phosphate and silicate were prepared in deionised water immediately prior to the cruise from oven dried (60C) salts. A primary mixed working standard solution was prepared each day from the stock solutions using the ship's DI water and the calibration standard solutions were prepared by the instruments autodiluter facility using OSIL Low Nutrient Sea Water for dilution, (OSIL, <http://www.osil.co.uk>, Batch LNS 25, Salinity 35). Five calibration standards and blank low nutrient seawater were run at the start of each batch of samples followed by a drift standard run in triplicate at the end of the batch. The calibration drift determined was accounted for in the calculation of the sample result (arithmetic methodology assumes a linear calibration drift correction from start to finish of the sample batch).

Data quality

A standard reference solution prepared from nutrient standard solutions and low nutrient sea water supplied by OSIL containing 1 μM NH_4 1 μM PO_4 , 10 μM SiO_2 and 10 μM NO_3 was run at the start, during and end of the entire analysis to check accuracy of the dried salt derived standards. A second standard reference of Pacific Ocean water supplied by Kanso Co. (Japan) (Lot. CG) was also analysed at the start and end of the cruise

Analytical precision was gathered by running each sample in triplicate and regularly yielded relative standard deviations (R.S.D.) of better than 2% for ammonium, phosphate and nitrate and better than 5% for silicate for concentrations greater than 1 μM . Errors on concentrations less than 1 μM would be greater than these. The method detection limit (MDL) of each nutrient was measured on 5 sets of analyses and calculated as 3 x S.D. of 3 replicates of the low nutrient sea water blank. This yielded MDL's of NH_4 , 0.1 μM ; PO_4 , 0.1 μM ; SiO_2 , 0.2 μM , and NO_3+NO_2 , 0.1 μM .

Table 9.2.1: Accuracy, determined by analysing the independent OSIL and Kanso reference standard solutions at the beginning and end of the cruise showed mean values of NH₄, 95%; PO₄ 96%; SiO₂, 95%, NO₃+NO₂, 96%,

Date	11/07/2017	11/07/2017	03/08/2017	05/08/2017	05/08/2017	Mean
Standard	OSIL	Kanso	OSIL	OSIL	Kanso	
(%)	(%)	(%)	(%)	(%)	(%)	(%)
NH ₄	89.9		99.0	95.9		95
PO ₄	97.6	94.3	91.8	97.8	97.6	96
SiO ₂	94.7	96.9	98.8	90.1	94.2	95
NO _x	98.3	99.6	93.8	93.8	93.6	96

Table 9.2.2: Precision (relative standard deviation, %) , determined from the OSIL and Kanso standard reference solutions yield precision values similar to those for the batches of samples: NH₄, 1%, PO₄, 2%; SiO₂, 2%; NO₃+NO₂, 1%,

Date	11/07/2017	11/07/2017	03/08/2017	05/08/2017	05/08/2017	Mean
Standard	OSIL	Kanso	OSIL	OSIL	Kanso	
(%)	(%)	(%)	(%)	(%)	(%)	(%)
NH ₄	1.8		1.1	1.5		1
PO ₄	0.5	0.9	3.5	1.8	1.8	2
SiO ₂	2.9	2.4	4.0	1.5	0.4	2
NO _x	0.1	0.4	1.0	1.2	1.4	1

Instrument problems

During the course of the cruise the instrument experienced a rotary valve failure on the ammonium manifold and a rotary valve blockage on the phosphate manifold. Both incidents, which occurred on the same day (20th of July), were thought to be due to particulate material that had been present in the sample (phytoplankton, zooplankton) and/or dust material from the air conditioning vent in the laboratory introduced into the sample vials whilst sitting in the autosampler. Close inspection of some of the micro tubing connections did show signs of material blockage and were easily cleaned but this was not possible for the factory sealed units of the rotary valves. In response to this, a number of changes were made. To ensure the continued successful analysis of 4 nutrients it was necessary to analyse the sample initially for ammonium and silicate and then for each batch of samples reconfigure the micro tube connections so that the phosphate and nitrate manifolds were connected to the two working rotary port valves and then run the instrument for these nutrients. This meant that the analysis time doubled but ensured the samples could be analysed on board. Further changes made were the introduction of a small length of silicon tubing with a 200um nylon mesh filter at one end for collection of the sample from the CTD bottle spigot to remove the possibility of a large plankton and particulate material and the placement of a square of polypropylene mesh filter over the exit of the air conditioning vent into the laboratory to prevent dust ingress. No problems with the instrument occurred after the introduction of these measures. Because of the increased time of analysis, doubling of sample requirement and doubling of the low

nutrient sea water matrix used for the calibration standards, the separate run for nitrite analysis that had been performed up until this date was largely curtailed.

Table 9.2.3 Sediment core samples analyzed

Event Number	Station	Samples	Ammonium	Phosphate	Silicate	NOx	Nitrite	Analysis date
101,102, 103	B13	42	√	√	√	√	√	17/07/2017
144, 145, 146	B15	45	√	√	√	√	√	20/07/2017
183, 184, 185	B16	43	√	√	√	√	√	23/07/2017
223, 225, 226	B17	44	√	√	√	√	√	25/07/2017
	B18	15	√	√	√	√	√	27/07/2017
292, 294, 295	B14	45	√	√	√	√	√	30/07/2017
379, 381, 392	B3	41	√	√	√	√	√	06/08/2017

In total 275 samples were collected and analyzed.

10. Benthic fauna

Rates of warming in the high northern latitudes are amongst the highest globally. One of the most obvious manifestations is the dramatic reduction in summer sea ice extent and thickness over the past few decades. These changes in ice cover exert cascading effects on Arctic Ocean carbon and nutrient dynamics, causing important feedbacks on the local benthic ecosystems, regional processes and the global climate system. The Arctic Ocean accounts for up to 14% of the global atmospheric CO₂ uptake and is therefore of fundamental importance to the global carbon cycle. However, changes to certain key components of Arctic ecosystems, such as benthic faunal assemblages or the extent of carbon and nutrient burial are often ignored in political and scientific discussions of a changing Arctic Ocean. However, the Arctic Ocean seafloor hosts a diverse and productive benthic ecosystem that is a crucial component of an intimately coupled benthic-pelagic system. The relative importance of benthic organisms in modulating sequestration, transformation and storage of bio-essential nutrients and carbon across the Arctic Ocean is still poorly constrained.

10.1 Community structure and biodiversity

^{1,2}Steve Widdicombe, ¹Joana Nunes (Plymouth Marine Laboratory), ^{1,2}Dave Barnes (British Antarctic Survey), ¹Christian März, ¹Allyson Tessin, ¹Johan Faust (University of Leeds), ¹Laura Grange, ¹Dan Wohlgemuth (University of Southampton), ¹Mark Stevenson (Newcastle University)

¹ Author, ² Dataset PI

ChAOS

Background and objectives

Benthic organisms residing on and within Arctic shelf sediments rely primarily on the supply of organic matter (OM) from the overlying water column. Consequently, seasonal and inter-annual patterns in pelagic primary production strongly influence the temporal patterns seen in the structure and function of benthic communities. In Arctic systems the quantity, quality and timing of this OM supply depends on the presence or absence of sea ice cover. Seasonal and inter-annual variation in the duration and intensity of ice cover will set the availability of light and nutrients for primary production, as well as providing additional pulses of OM from specific under-ice algae. Therefore, benthic assemblage composition, organism activity and standing stock are likely to differ considerably along the continuum of sea ice-covered to open water, with inevitable effects on the key ecosystem functions provided by benthic organisms and the biogeochemical processes they support. Specifically, ecosystem

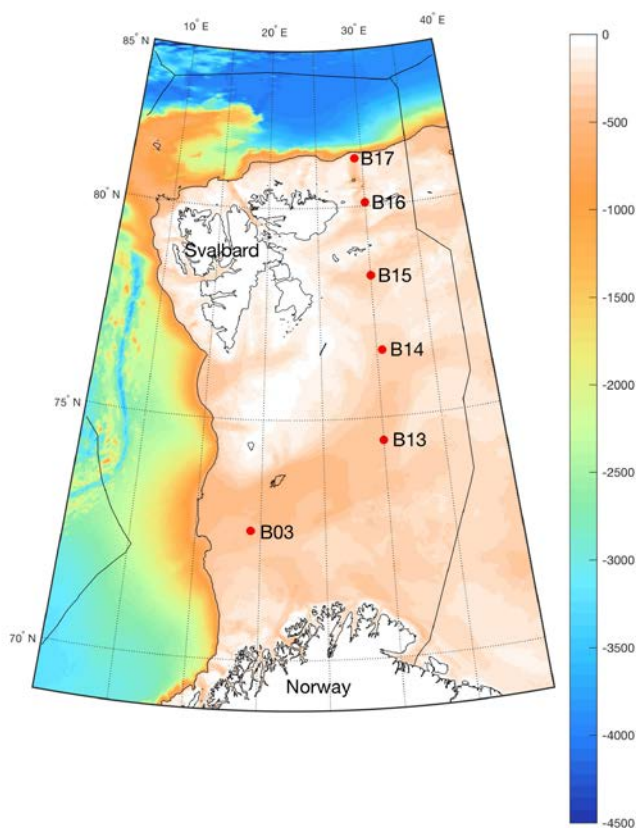

Figure 10.1.1. Location of the 6 full ChAOS project benthic sampling stations

functions such as carbon accumulation and storage, secondary production and energy transfer to higher trophic levels, and nutrient cycling (transformations and fluxes) depend heavily on all aspects of the biological system, from microbes to megafauna. To begin to understand the importance of sea ice conditions on the structure, function and diversity of benthic communities inhabiting shelf sediment habitats, a transect of 6 Stations (B3, B13, B14, B15, B16 and B17) was sampled that ran from ice free NE Atlantic dominated communities in the south (B3) to predominately ice covered Arctic dominated communities in the north (B17) (Figure 10.1.1).

Sampling strategy/instrument description

To collect organisms across the full range of benthic invertebrates a range of sampling equipment was deployed at each of the 6 ChAOS benthic stations (B3, B13, B14, B15, B16, B17). Four specific animal groups were sampled. The smallest organism group collected was the *meiofauna*. These organisms are defined as those animals that live within the interstices between the sediment grains and are generally retained on a 63 μ m mesh. Larger than the meiofauna are the *macrofauna* and these organisms are large enough to move sediment particles and construct sediment features, such as tubes and burrows. This group is defined as those organisms large enough to be retained on a 0.5mm mesh. The next group is the *mega-infauna* and these are the large bodied, sparsely distributed organisms living within the sediment and are retained on a 1cm mesh. Finally there are the large bodied organisms that live on or near the sediment surface known as the *epifauna*. These are either collected using a trawl or observed using camera systems. Depending on the size of sample required for each of specific organism groups, two types of boxcorer were deployed; the USNL corer (surface area 0.1m²) and the larger SMBA corer (surface area 0.5m²). Samples for meiofauna and macrofauna were collected using the USNL corer, whilst samples for mega-infauna were collected from the SMBA corer. In addition to the faunal samples, sediment samples were collected for sediment particle size analysis (PSA) to characterize the sediment type at each station.

Methods/Processing/Calibrations

Meiofauna and Macrofauna: At all ChAOS benthic stations, 5 replicate 0.1m² sediment cores were collected using the USNL boxcorer. The overlying water was drained off to reveal the sediment surface. In each core, three 50ml syringe corers were then pushed into the sediment to a depth of approximately 8 cm. The sediment from these 3 x 50ml cores was pooled into a pot and preserved with 10% buffered (borax) formaldehyde solution. These samples will be returned to Plymouth Marine Laboratory (PML) where the meiofauna (organisms >63 μ m) will be extracted, identified, measured and their biomass calculated. The remaining sediment in the core was sieved over a 0.5mm sieve and the residues placed into a pot and preserved with 10% buffered formaldehyde solution. This residue will be returned to PML where the macrofauna (organisms >0.5mm) will be extracted, identified and weighed.

Megafauna: At all ChAOS benthic stations, 5 replicate 0.5m² sediment cores were collected using the SMBA boxer corer. Each sample was sieved through a 1cm mesh and the residue placed into a pot and preserved with 10% buffered formaldehyde solution. This residue will be returned to PML where the megainfauna (organisms >1cm) will be extracted, identified and weighed.

Epifauna (collection): At each of the ChAOS benthic stations, epifauna were collected from 6 separate 1.25m wide Agassiz trawl tows. The trawl was paid out at a winch speed that kept the tension off the wire until a length of cable had been deployed that was between 1.5 and 2 times the water depth. The pay-out was then halted and the timing for the trawl was started at this time. After either 5 or 15 minutes the trawl recovery started and this point constituted the end of the trawl time. At the start and end of the trawl period both location and time were recorded. The first 3 trawl tows were conducted for 5 minutes each at a ship speed of 1 knot. The sediment collected from these

trawls was sieved over a stacked 1cm then 1mm mesh. The residue was then picked and the fauna allocated to Class. The fauna are then preserved in 96% ethanol and returned to the British Antarctic Survey where the different groups (Class) will be dispersed to taxonomic experts across the World where they will be identified to species level (where possible). In addition, genetic studies will be run on target species and carbon content (inorganic and organic) of these organisms will also be calculated. The second 3 trawl tows were conducted for 15 minutes each at a ship speed of 1 knot. On recovery the sediment from the trawl cod end was sieved over a 1cm mesh and the fauna recovered were placed in a 5 litre bucket and preserved with 10% buffered formaldehyde solution. These fauna will be returned to Plymouth Marine Laboratory where they will be identified to species (where possible) and weighed (blotted wet weight and decalcified wet weight). These data will be used to quantify the community structure and biomass of large epifaunal organisms at each of the 5 benthic stations. This material will then be supplied to Dr Laura Grange (University of Southampton) for histological analysis (Section 10.2).

Epifauna (observation): At each of the ChAOS benthic stations, as well as at a number of pelagic stations, the Shallow Underwater Camera System (SUCS) was deployed. Twenty replicate 0.5 square meter quadrats were photographed per site. At pelagic stations just one site was selected but at ChAOS benthic station, 3-4 sites were selected. Each photograph was georeferenced using USBL lander beacon communication with ship. Substrate and rugosity information was taken from visual examination of images and environmental data was added from the deepest depth of the nearest CTD performed to each SUCS deployment. Finally faunal functional group presence was added from visual analysis of photographs. Further processing of images takes place at BAS, Cambridge both visually and using image analysis software.

Particle Size Analysis: At each of the ChAOS benthic stations, 5 USNL cores were subsampled for Particle Size Analysis (PSA). In each core, three 50ml syringe corers were pushed into the sediment to a depth of approximately 8 cm. The sediment from these 3 x 50ml cores was pooled and placed into a plastic bag which was sealed and then placed into a -20°C freezer. These samples will be returned to PML and analysed.

Data quality notes/ problems

There were no significant sample collection or data quality issues to note. The sediment at Station B17 was more patchy and stony than other stations and this resulted in a few more boxcore failures due to the corer failing to close properly. In addition the presence of fast ice at B17 made the location of suitable sampling locations more time consuming. This did not affect the quality of the samples eventually collected rather the time taken to recover the required number of 'good' samples. In general the USNL sampling for the 5 USNL cores needed for meiofauna and macrofauna took approximately 2 hours per station. The collection of 5 SMBA cores for megafauna also took approximately 2 hours. The Agassiz trawls took approximately 1 hour each. SUCS took approximately 50 mins per site, thus 2.5 hours for a benthic station.

Samples collected

Sampling details for Benthic Community Structure and Biodiversity			Stations						
			B3	B13	B14	B15	B16	B17	
			Date	5 / 6 August	16 / 17 July	30 / 31 July	19 / 20 July	22 July	27 July
			Approx location	72 38 N 19 15 E	74 30 N 30 00 E	76 30 N 30 30 E	78 15 N 30 01 E	80 06 N 30 06 E	81 18 N 29 10 E
Depth	370m	359m	290m	316m	290m	310m			
Sample	Kit	# Reps	Event numbers						
Meiofauna	USNL (Sub-core)	5	394	125	322	166	206	264	
			395	126	323	167	207	265	
			396	127	324	168	208	269	
			399	128	325	169	209	270	
			400	129	326	170	210	271	
Macrofauna	USNL	5	394	125	322	166	206	264	
			395	126	323	167	207	265	
			396	127	324	168	208	269	
			399	128	325	169	209	270	
			400	129	326	170	210	271	
Mega-infauna	SMBA	5	385	111	310	151	190	255	
			386	112	311	152	191	256	
			387	113	312	153	192	257	
			388	114	313	154	193	258	
			389	115	314	155	194	260	
Epifauna	1.25m Agassiz (5 mins)	3	401	131	300	171	211	239	
			402	132	302	172	212	240	
			403	133	304	173	215B	241	
Epifauna	1.25m Agassiz (15 mins)	3(4)	404	134	305	174	216	242	
			405	136	306	176	217	243	
			406	137	307	177	218	244	
			407						
Epifauna	SUCS	20 photos site ⁻¹ 1-4 sites station ⁻¹	378	100	291	142	178	219	
				109		143	179	220	
				110			180	221	
								222	
PSA	USNL (Sub-core)	3 – 8	390	116	315	156	195	227	
			392	117	316	157	197	228	
			393	118	317	158	198	229	
				119	318	159	199	230	
				121	319	161	200	272	
								274	
								275	

Table 10.1.1: Samples taken to describe benthic community abundance, diversity and structure.

In addition to the samples described above, additional SUCS deployments were conducted at a number of pelagic stations (Table 10.1.2).

Stn	Date	Approx location	Depth	Replicates	Event Numbers
B1	7 th August 2017	70.5 N, 20.0 E	180	20	415
B4	9 th July 2017	73.4 N, 18.9 E	470	19	25
B5	4 th August 2017	74.4 N, 18.2 E	118	20	369
B6	10 th July 2017	75.2 N, 17.5 E	141	20	36
B7	3 rd August 2017	76.0 N, 16.8 E	318	20	361
B8	11 th July 2017	76.4 N, 16.7 E	42	21	51
B11	14 th July 2017	76.3 N, 21.0 E	228	20	83
B12	15 th July 2017	75.5 N, 26.0 E	131	20	94
B20	14 th July 2017	76.0 N, 14.5 E	320	20	75

Table 10.1.2: Additional SUCS deployments conducted at non-ChAOS stations.

Results

The majority of samples will be analysed once returned to either PML or BAS. Consequently, there are limited preliminary data available for this section. However, exemplar images from the SUCS are shown below illustrating the type of epifauna observed at the 6 ChAOS benthic stations.

Station B3: Sponges (left) and large burrows (right) were abundant



Station B13: Sponges (left) and decapod crustaceans (right) were abundant

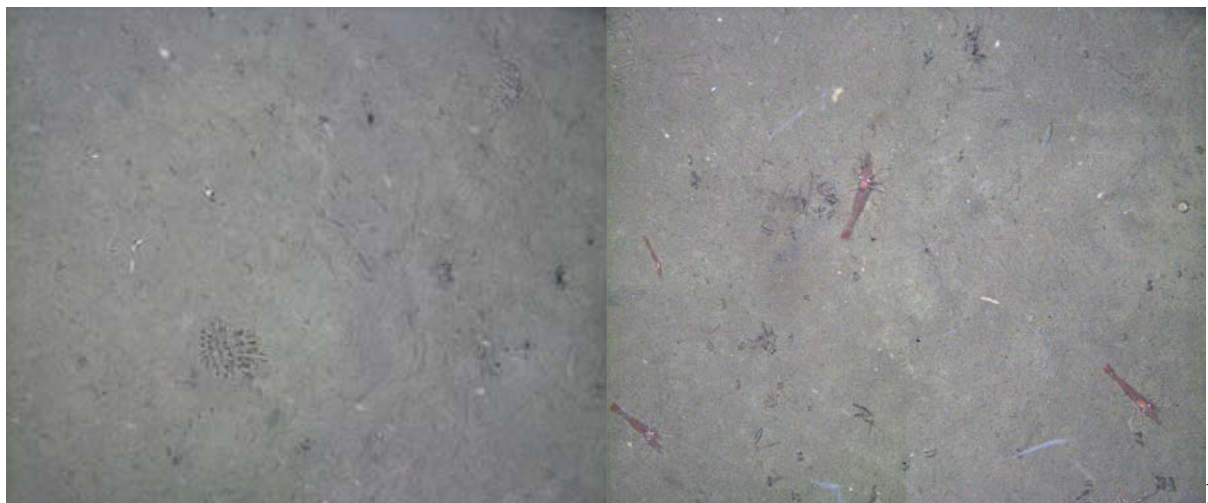

Station B14: Epifauna (e.g. Asteroids - sea stars, left) were sparse but Arctic cod (right) were common.



Station B15: Ophiuroids (brittlestars and basket stars) were characteristic.



Station B16: Epifauna was patchily dense and rich, particularly including echinoderms and cnidarians.

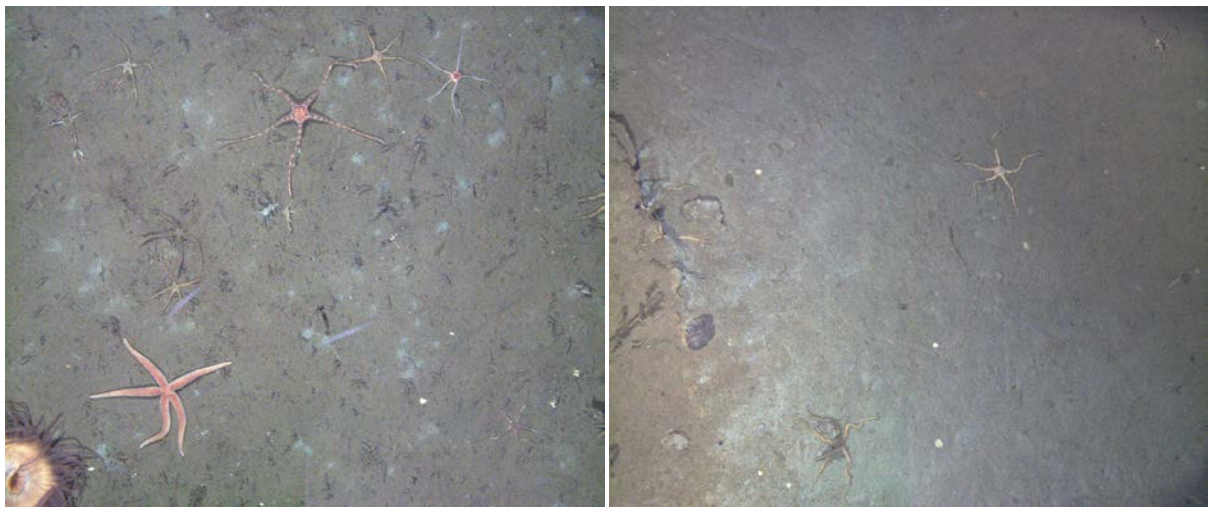

Station B17: Shelf break dropstones were oases of encrusting fauna (left). Active burrows showed considerable bio-excavation of surface sediments.

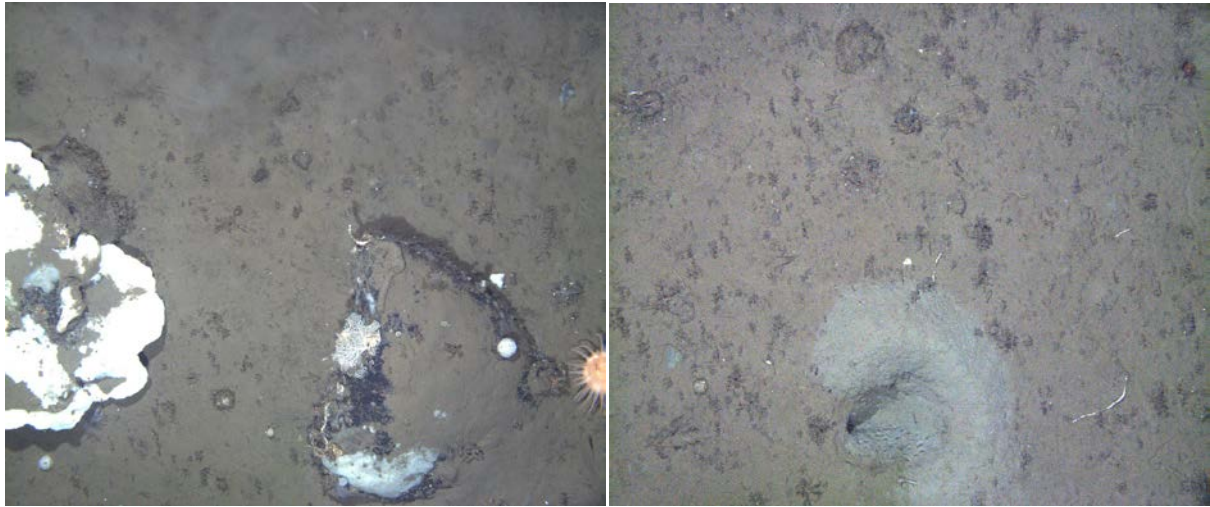

Analysis of similar imagery in combination with trawl specimens from previous work conducted from RRS James Clark Ross has been used by the Antarctic Seabed Carbon Capture Change project (see www.ascce.co.uk) to investigate seafloor carbon storage gains with sea ice losses around West Antarctica.

In advance of full PSA data, visual inspection of the sediment collected at each station by the USNL corer would indicate that sediment type is reasonably consistent across the 6 ChAOS benthic stations (Figure 10.1.2).

Station B3



Station B13



Station B14



Station B15



Station B16



Station B17



Figure 10.1.2: Sediment surface images from the 6 ChAOS benthic sites. Sediment collected by USNL box corer.

10.2 Reproductive state

^{1,2}Laura Grange (University of Southampton)

¹ Author, ² Dataset PI

ChAOS

Background and objectives

To understand the levels of diversity and resilience of species to changing sea ice conditions, analyses of reproductive metrics (e.g. gonad index, oogenic and spermatogenic maturity stage, oocyte size and female fecundity) will be used to determine the reproductive ecology and capacity/success for functionally important benthic invertebrates at each of the ChAOS benthic stations.

Sampling strategy/instrument description

At each of the ChAOS stations, samples of fauna were taken for reproductive analysis from 3 representative 15-minute 1.25 m wide Agassiz trawl tows. Fauna sieved from sediment over a 1 cm mesh were retained, catalogued and photographed, and then preserved in 10% buffered formal saline solution for analysis at the National Oceanography Centre Southampton.

Methods/Processing/Calibrations

At each of the ChAOS benthic stations, epifauna were collected from 3 separate Agassiz trawl tows using the deployment and processing methods described above in Section 10.1. In brief, the trawl tows were undertaken for 15 minutes each at a ship speed of 1 knot. On recovery the trawl catch, including sediment was sieved over a 1cm mesh. The fauna retained were catalogued and photographed, and then placed in a 5 litre bucket and preserved with 10% buffered formal saline solution. These fauna will be firstly returned to Plymouth Marine Laboratory where they will be identified to species (where possible) and their biomass determined. Selected target species, determined by species abundance and dominance, will then be transferred to the National Oceanography Centre Southampton where they will be measured to establish individual size and wet weight, dissected to remove discrete reproductive tissues and processed through standard wax histology techniques (dehydration, clearing, impregnation and embedding in molten wax, and sectioned at 7 μ m using a rotary microtome). Following sectioning, glass slides of thin tissue sections will be stained using hematoxylin and eosin, and viewed under a compound microscope. Reproductive metrics including oocyte size and maturity, and spermatogenic maturity stage will then be quantified and described.

Data quality notes/ problems

There were no notable issues experienced with sample collection or data quality. However, our objective to sample the same representative species across all sites will need to be revised and consideration given to the numbers of individuals and diversity of species collected at each station.

Samples collected

Stn	Date	Approx location	Depth	Reps	Event Numbers
B3	6 th August	72 38 N 19 15 E	370m	4	404, 405, 406, 407
B13	17 th July	74 30 N 30 00 E	359m	4	134, 135 (net twisted), 136, 137
B14	30 th July	76 30 N 30 30 E	293m	3	174, 175 (misfire), 176, 177
B15	20 th July	78 15 N 30 01 E	316m	3	305, 306, 307
B16	23 rd July	80 06 N 30 06 E	290m	3	216, 217, 218
B17	25 th July	81 16 N 29 14 E	330m	3	242, 243, 244

[N.B. The trawl net was recovered twisted during event number 135. The catch was therefore not deemed suitable for community analysis (Plymouth Marine Laboratory), however samples were retained for the reproductive study (University of Southampton).]

Table 10.2.1: Sampling details for organisms collected for reproductive analysis.

Results

Samples will be analysed once returned to the National Oceanography Centre Southampton. Consequently, there are limited preliminary data available for this section. However, exemplar images of the fauna collected are shown below illustrating the type of epifauna observed at the 6 ChAOS benthic stations (Figure 10.2.1).

Station B3



Station B13



Station B14



Station B15



Station B16



Station B17



Figure 10.2.1: Example of organisms collected at the 6 ChAOS benthic sites from 15 min Agassiz trawl deployments.

10.3 Microbial community and diversity

¹Steve Widdicombe, ¹Joana Nunes, ²Karen Tait (Plymouth Marine Laboratory), ¹Christian März (University of Leeds), ¹Mark Stevenson (Newcastle University)

¹ Author, ² Dataset PI

ChAOS

Background and objectives

Biogeochemical processes in the sediment result from the combined effort of billions of individual microorganisms with highly diverse metabolic activities and rates. The observed depth profiles of their main substrates and products are the net result of the complex networks of these metabolic interactions. However, the vast majority of diagenetic models do not provide an explicit description of microbial dynamics. Many assume that microbial biomass is in a steady state or assume a negligible influence of microbes beyond transient timescales. Thus, they cannot be directly applied to investigate and predict the interplay between microbial dynamics/community structure and the geochemical environment. In addition, microbial growth kinetics might result in a lagged response to changing environmental conditions, thus highlighting the potential benefits of geomicrobial models for the transient case. In parts of the Arctic, sediment microbial communities are dominated by dissimilatory Fe and Mn reducers, revealing a strong link with both the inorganic sediment composition and the type of organic matter (OM) delivered to the seafloor. Higher amounts of labile OM could shift microbial systems towards sulphate reduction, leading to profound changes in the Fe-S systematics and associated recycling or burial of sedimentary P. Also, microbial assemblages that might become active in the Arctic under changing conditions can influence nutrient cycling by, e.g., N fixation or anammox, thereby increasing the bioavailable pools of benthic nutrients. These microbiology-geochemistry links remain untested in the Arctic.

Sampling strategy/instrument description

At each of the ChAOS stations, samples of sediment were taken for DNA analysis from different depths within the sediment (0.5 cm resolution from 0 to 2 cm; 1 cm resolution below 2 cm). At each station, samples were taken from 3 separate megacore tubes and full details of the megacore sampling are presented in Section 9.

Methods/Processing/Calibrations

In summary, DNA samples were generally taken from the same sediment slices as organic geochemistry samples, except in one instance where samples were taken for two inorganic chemistry cores. Samples were taken using either fresh sterile or ethanol-washed plastic spatulas to transfer the sediment into sterile plastic vials. To avoid contamination the work area was regularly sprayed with ethanol and nitrile gloves were worn. DNA samples were transferred to the -80° C freezer immediately after sampling, in most cases this was within 10 minutes. Samples will be transferred to PML for further processing and analysis to determine the microbial community structure and diversity.

Data quality notes/ problems

Issues associated with megacorer sampling and core slicing are covered in Section 9. There were no other significant DNA sample collection or data quality issues to note.

Samples collected

For details on where and when DNA samples were collected see Section 9.

Results

All DNA will be analysed once returned to either Plymouth Marine Laboratory or Newcastle University. Consequently, there are no preliminary data available for this section.

11. Benthic community function

At the seafloor, a significant proportion of organic matter (OM) from marine, terrestrial, or sea ice sources is remineralised *via* microbially mediated processes (e.g., denitrification, ammonification, Fe/Mn or sulphate reduction) that are coupled to the activity of benthic meio-, macro- and mega-fauna (e.g., *via* bioturbation, bioirrigation). These coupled biological and biogeochemical processes lead to a partition of the carbon and nutrient pools into a fraction that is recycled to drive a benthic-pelagic feedback loop, and a fraction that is buried in sediments. The resulting feedback with water column processes (physical mixing, primary productivity) are more pronounced than in the open ocean and, on the Arctic shelf, plays a crucial role for benthic-pelagic coupling and ecosystem productivity, as well as the long-term removal of carbon from the ocean-atmosphere system. Key uncertainties exist, however, in how changes in sea ice cover, with a trend to thinner and reduced ice cover that exhibits significant inter-annual variability, will alter existing biological community composition and structure, biogeochemical processes, and associated ecosystem functioning. Understanding these changes to the benthic environment is of critical importance to understanding the Arctic Ocean ecosystem as a whole.

11.1 Nitrogen cycling

¹Steve Widdicombe, ^{1,2}Joana Nunes (Plymouth Marine Laboratory),

¹ Author, ² Dataset PI

ChAOS

Background and objectives

To understand the effects of differing organic matter (OM) supply, due to various states of ice cover, on the dominant pathways of nitrogen transformation, isotopes ($\delta^{15}\text{N}$) will be used to assess processes of N immobilisation and microbial processes at each of the ChAOS benthic stations.

Sampling strategy/instrument description

To determine rate measurements for important N-cycling sediment processes (*nitrification*, *denitrification* and *anammox*) bottled sediment samples and sediment cores spiked with ^{15}N were collected and incubated for 24 hours. Incubations were conducted at each of the ChAOS benthic stations (B3, B13, B14, B15, B16, B17) with all N-cycling cores being collected from the USNL corer.

Methods/Processing/Calibrations

Nitrification rates: At each ChAOS benthic station, 12 replicate samples of surface sediment were collected in pre-weighed, 14 mL glass vials (using a 50mL syringe to take up the surface layer down to 0.5 cm depth). Approximately 4-5 mL of sediment was collected in each vial and filled with bottom water to create a slurry. Subsets of the slurries were amended with 0.1 mL of 1M zinc chloride (ZnCl_2 ; n=3), 0.1 mL of 1M allylthiourea (ATU; n=3) and 0.1 mL of 1M sodium chlorate (NaClO_3 ; n=6) and incubated in the CT-room at bottom temperature for ca. 24 hours. A parallel incubation without sediment (bottom water + treatments) was conducted at the same time. At the end of the incubation period, 0.1 mL of

1M ZnCl₂ was added to all the bottles for preservation. Ammonium oxidation rates will be measured as rates of nitrite accumulation in the NaClO₃-treated samples compared to the ATU-treated samples. The initial ZnCl₂ treatment acts as the starting point. Sediment rates will be corrected for ammonium oxidation in bottom water.

Denitrification and Anammox rates: At each ChAOS benthic station, 12 replicate cores were collected (i.d. 7 cm) from 3-4 separate USNL cores. Each core-tube had approximately 15-20 cm of sediment and 10-15 cm of overlying water. Overlying water was discarded from each core and replaced with bottom water amended with ¹⁵NO₃⁻ (Three treatments: +0 μM, +50 μM, +200 μM ¹⁵NO₃⁻). The +0 treatment was homogenized with a power tool and the slurry decanted into 125 mL glass bottles. 1 mL of 1M ZnCl₂ was added for preservation and the bottles were sealed with Teflon-lined rubber septa and Al-crimps. The remaining two treatments were incubated in the CT-room, at bottom water temperature for ca. 24 hours. Magnetic flees were suspended in the core tubes and agitated by an external electromagnetic circuit. After the incubation period, the cores were homogenized and preserved as above. Denitrification and Anammox rates will be determined post-cruise by membrane inlet mass spectrometry.

Data quality notes/ problems

There were no significant sample collection or data quality issues to note. However, incubation temperature did change during the incubation of B16 sediments due to an emergency requirement for the cool room within which the incubations were being conducted.

Samples collected

Stn.	Location	Date	Depth	Bottom water (T°C)	Cool lab (T°C)	Event #
B3	72 38 N 19 15 E	6 th Aug	370m	3.94	2.6	390, 392, 393
B13	74 30 N 30 00 E	16 th July	359m	1.78	4	116, 117, 118, 119
B14	76 30 N 30 30 E	31 st July	290m	1.95	1	315, 316, 317
B15	78 15 N 30 01 E	19 th July	316m	-1.49	4	156, 157, 158, 159
B16	80 06 N 30 06 E	22 nd July	290m	-1.44	1	195, 197, 198, 199
B17	81 18 N 29 05E	27 th July	310m	1.76	1-4	272, 274, 275

Table 11.1.1: Sampling details for nitrification and denitrification incubations.

Results

All the samples will be analysed once returned to Plymouth Marine Laboratory. Consequently, there are no preliminary data available for this section.

11.2 Bioturbation

^{1,2}Laura Grange, ¹Dan Wohlgemuth, ²Martin Solan (University of Southampton)

¹ Author, ² Dataset PI

ChAOS

Background and objectives

A large fraction of the deposited organic matter (OM) may be decomposed within the shallow sediment horizons and, therefore, micro- through to mega-benthic activity exerts an important influence on OM degradation on different spatial and temporal scales. Metazoan bioturbation enhances OM degradation rates by accelerating the supply of terminal electron acceptors (TEAs), preventing the accumulation of metabolic inhibitors, or by stimulating priming, i.e., the mixing of freshly deposited material into deeper sediment layers. In addition, bioturbation and bioirrigation also play an important role for the magnitude of exchange fluxes through the sediment-water interface, shaping faunal structure and function. Especially at shallow water depth, bioirrigation accounts for a large fraction of the total TEA fluxes, which complicates the use of concentration profiles for the determination of total TEA fluxes by molecular diffusion. Furthermore, bioirrigation accounts for major losses of reduced chemical species from the sediment to the water column prohibiting their re-oxidation inside the sediment. The linked processes of OM remineralisation and nutrient recycling are catalysed by complex interacting microbial communities.

Sampling strategy/instrument description

To ascertain *in situ* rates of bioturbation and bioirrigation, sediment cores of intact macrofaunal benthic communities were collected, fluorescent-dyed sediment particles (luminophores) were then added and incubated over a 12-day period. Incubations were conducted at each of the ChAOS benthic stations (B13, B14, B15, B16, B17), with the exception of B3, with all cores being collected from the USNL corer. Sediment and macrofaunal samples were additionally collected to undertake controlled climate experiments on two functionally important and numerically dominant macrofaunal species. These cores were maintained shipboard at ambient bottom water temperatures in preparation for a controlled mesocosm experiment at the National Oceanography Centre Southampton. Sediment and macrofauna were collected at benthic station B13 using an SMBA corer and Agassiz trawl, respectively.

Methods/Processing/Calibrations

Bioturbation and bioirrigation: At each ChAOS benthic station, excluding B3, 4 replicate cores were collected (i.d. 20 cm) from four separate USNL cores. Each core-tube had approximately 15-20 cm of sediment. None of the overlying water was retained. Uncontaminated surface seawater was added to each core (~ 5-6L) and the sediment allowed to settle over a 48-hour period in a shipboard, controlled-temperature experimental room (set at 1 °C). After the initial 24-hour incubation period had passed a small amount of fish food was added to the cores and aeration turned on. At 48-hours the overlying water was exchanged and replaced with uncontaminated surface seawater. A further 1-2 hours was allowed for any resuspended sediment to settle. Experiments started with the removal of 30 ml of overlying seawater from each replicate core for nutrient analysis (i.e. NO₂, NO₃, NH₃/NH₄, PO₄) and the addition of luminophores to the sediment surface. From this point

forward the shipboard incubations were sampled at 2-day intervals over a 12-day period to quantify the exchange rates of nutrients in the core top waters. Water samples were also taken at the end of the 12-day incubations after the addition of sodium bromide to quantify net-changes in bromide (Br-) concentration as a tracer for benthic solute exchange (i.e. bioirrigation). Bioturbation of the intact faunal assemblage collected in each core/ mesocosm was then analysed using a sediment imaging camera and standard image analysis techniques. At the end of the incubation experiments, dominant macrofaunal species were sieved at 500 µm, retained and preserved in 10% buffered formal saline for identification at the University of Southampton.

Climate experiments: At B13, surface sediment (i.e. top 10 cm) was recovered and sieved at 500 µm from ten replicate SMBA deployments. This sediment was allowed to settle over a period of 48 hours and the overlying top water siphoned off, before being distributed (~15 cm depth) between 20 small (i.d. 10 cm) and 6 large (i.d. 20 cm) cores. In addition and from the same station, two target species (*Ctenodiscus crispatus* and Bivalve sp) of adult size were sampled from 4 replicate 15-minute Agassiz trawls. Any additional individuals of the target species recovered in the SMBA cores were also retained. Solitary individuals of both species were individually placed into each of 10 replicate (i.d. 10 cm) cores (i.e. 20 small cores in total). The remaining individuals were equally distributed between 4 (*Ctenodiscus crispatus*) and 2 (Bivalve sp) large cores in single species assemblages, respectively. At this point a small amount of fish food was added to each core and aeration turned on. These cores were maintained at ambient bottom water temperatures and the overlying water exchanged for uncontaminated surface seawater after 7 days. Fish food was provided 1-2 times per week. Controlled climate experiments under present and future (year 2050) environmental conditions will be undertaken for a period of 6 months once the cores are returned to the National Oceanography Centre, Southampton.

Data quality notes/ problems

In the case of the incubation cores, there were no significant sample collection problems, however we did experience some issues with the maintenance of the cores collected from the first two benthic stations (B13(1) and B15(1)). After recovery, these cores were staged in a cold, controlled-temperature container on deck that is cooled by the uncontaminated seawater supply. In ice conditions the seawater intake was switched off owed to ice crystals blocking the intake pumps. The uncontaminated seawater pump remained off for the time period over which we were sampling in ice. This action caused the ambient temperature in the container to rise to 10 °C over a relatively short time period (~ 2 hrs), after which it proved impossible to return and maintain the temperature to an appropriate level (~ 2 C). The cores incubated in the container during this time were therefore lost. Sampling of the affected sites (i.e. B13(2) and B15(2)) were repeated to replace the lost cores and all further incubations were staged in the shipboard, controlled-temperature experimental room (set at 1 °C).

There were no significant sample collection or data quality issues to note with the collection of the climate experiment cores. However, owed to further temperature control issues in the cold, controlled temperature container, the climate cores were transferred to the shipboard, controlled-temperature experimental room prior to the Tromso port call (7th August).

Samples collected

Table 11.2.1: Sampling details for the collection of cores for bioturbation incubations.

Station	Location	Date	Depth	Event #
B13 (1)	74 30 N 30 00 E	16 th July	359 m	120, 121, 122, 123, 123
B13 (2)	74 30 N 30 00 E	1 st August	358 m	331, 332, 333, 334
B14	76 30 N 30 30 E	31 st July	293 m	318, 319, 320, 321
B15 (1)	78 15 N 30 01 E	19 th July	316 m	161, 162, 163, 164, 165
B15 (2)	78 15 N 30 01 E	29 th July	316 m	286, 287, 288, 289
B16	80 06 N 30 06 E	22 nd July	290 m	200, 201, 204 (misfire), 203, 205
B17	81 16 N 29 14 E	22 nd July	330 m	227, 228, 229, 230

[N.B. We undertook 5 replicate cores at stations B13(1) and B15(1). However, at all other benthic stations we were limited to 4 replicate cores owed to the volume of consumables remaining (i.e. luminophores and sodium bromide for bioturbation and bioirrigation measurements respectively).]

Table 11.2.2: Sampling details for the collection of cores and organisms for the climate incubations.

Station	Location	Date	Depth	Gear	Event #
B13	74 30 N 30 00 E	1 st August	359 m	SMBA	335, 336, 337, 338, 339, 340, 341, 342, 343, 344
B13	74 30 N 30 00 E	1 st August	359 m	Agassiz trawl	345, 346, 347, 348

Results

Shipboard incubations were sampled at 2-day intervals over a 12-day period to quantify the exchange rates of nutrients in the core top waters including NO₂, NO₃, NH₃/NH₄ and PO₄. These samples were, where possible, analysed onboard by Tim Brand (Scottish Marine Association Scotland). However, these data are still being processed. Any remaining water samples were frozen at -20 °C and will be analysed at the Scottish Marine Association Scotland. Water samples were also taken at the end of the 12-day incubations to quantify net-changes in bromide (Br⁻) concentration as a tracer for benthic solute exchange. These samples will be returned to the National oceanography Centre Southampton for analysis. At the end of the shipboard experiments, bioturbation of the intact faunal community will be quantified using a sediment imaging camera used to detect luminophores mixed into the sediment and the dominant macrofaunal species will be sieved at 500 µm, recovered and preserved in 10% buffered formal saline. The sediment images and preserved macrofaunal samples will be returned to the National Oceanography Centre, Southampton, for analysis and identification to species (where possible), respectively. Consequently, there are no preliminary data available for this section. The shipboard climate incubation cores will be transferred to a controlled temperature and CO₂ facility at the National Oceanography Centre, Southampton. Experiments to expose animals to present and future (year 2050) environmental conditions will be undertaken over a 6-month period and the results analysed on completion. Consequently, there are no preliminary data available for this section.

12. Appendix A - Cruise Event Log

EVENT	STATION	ID	TYPE	START (deployed)			AT BOTTOM			END (on deck)			WDEPTH	PERSON	COMMENTS
				DATE	LATITUDE	LONGITUDE	DATE	LATITUDE	LONGITUDE	DATE	LATITUDE	LONGITUDE			
1	B1	CTD001	CTD	07/07/2017 17:05	70.76661	20.00051	07/07/2017 17:13	70.76664	20.00054	07/07/2017 17:28	70.76663	20.0005	192	E Dummont	Shakedown station, bottle 17 leaking
2	B1	DG001	Day Grab	07/07/2017 18:02	70.76663	20.00046	07/07/2017 18:13	70.76663	20.00048	07/07/2017 18:22	70.76664	20.00046	192	C Maerz	Deployment 1
3	B1	MC001	MultiCorer	07/07/2017 18:46	70.76664	20.00049	07/07/2017 18:51	70.76663	20.00052	07/07/2017 19:02	70.76662	20.00053	192	C Maerz	Deployment 2
4	B1	MC002	MultiCorer	07/07/2017 19:32	70.76663	20.00049	07/07/2017 19:39	70.76663	20.00051	07/07/2017 19:49	70.76665	20.00052	192	C Maerz	Deployment 3
5	B1	MC003	MultiCorer	07/07/2017 20:10	70.7668	20.00049	07/07/2017 20:16	70.76683	20.00053	07/07/2017 20:26	70.76682	20.00051	192	C Maerz	Deployment 4
6	B2	CTD002	CTD	08/07/2017 09:10	71.69996	19.66596	08/07/2017 09:19	71.69998	19.666	08/07/2017 09:41	71.69997	19.66597	256	E Dummont	Bottle 17 leaking
7	B2	ZP001	ZooNet	08/07/2017 10:04	71.69997	19.66594				08/07/2017 10:08	71.69996	19.66599	256	S Reed	Failed
8	B2	ZP002	ZooNet	08/07/2017 10:14	71.69997	19.66599	08/07/2017 10:25	71.69995	19.66603	08/07/2017 10:40	71.69996	19.66593	256	S Reed	Deployment 1, 200m deep
9	B2	ZP003	ZooNet	08/07/2017 10:44	71.69996	19.66604				08/07/2017 11:01	71.69996	19.666	256	S Reed	Deployment 2, 200m deep
10	B2	SAPS001	SAPS	08/07/2017 11:58	71.69996	19.66602				08/07/2017 13:55	71.69997	19.66603	256	C Vega	Deployment 1
11	B2	DG002	Day Grab	08/07/2017 13:57	71.69995	19.66603	08/07/2017 14:04	71.69998	19.66601	08/07/2017 14:08	71.69998	19.666	256	C Maerz	Deployment 1, failed
12	B2	DG003	Day Grab	08/07/2017 14:10	71.69998	19.66601	08/07/2017 14:19	71.69996	19.66598	08/07/2017 14:24	71.69996	19.66598	256	C Maerz	Deployment 2
13	B2	MC004	MultiCorer	08/07/2017 14:51	71.7	19.66602	08/07/2017 15:00	71.69999	19.66599	08/07/2017 15:16	71.70001	19.66598	256	C Maerz	Deployment 1
14	B2	MC005	MultiCorer	08/07/2017 15:37	71.70017	19.66598	08/07/2017 15:44	71.70017	19.66596	08/07/2017 15:54	71.7002	19.666	254	C Maerz	Deployment 2
15	B2	MC006	MultiCorer	08/07/2017 16:09	71.70019	19.66658	08/07/2017 16:16	71.70019	19.66659	08/07/2017 16:26	71.7002	19.66659	254	C Maerz	Deployment 3
16	B2	ZP004	ZooNet	08/07/2017 20:57	71.70018	19.66659	08/07/2017 21:08	71.70019	19.6666	08/07/2017 21:21	71.70018	19.66661		S Reed	Deployment 1, 200m deep
17	B2	ZP005	ZooNet	08/07/2017 21:23	71.70019	19.66662	08/07/2017 21:32	71.70019	19.66659	08/07/2017 21:43	71.70021	19.66655		S Reed	Deployment 2, 200m deep
18	B4	CTD003	CTD	09/07/2017 08:57	73.36779	18.91803	09/07/2017 09:09	73.36781	18.91802	09/07/2017 09:43	73.36781	18.918	469	E Dummont	
19	B4	ZP006	ZooNet	09/07/2017 09:56	73.36781	18.918				09/07/2017 10:18	73.36781	18.91803		S Reed	Deployment 1, 200m deep
20	B4	ZP007	ZooNet	09/07/2017 10:20	73.36781	18.91803	09/07/2017 10:32	73.36779	18.91807	09/07/2017 10:43	73.3678	18.91807		S Reed	Deployment 2, 200m deep
21	B4	SAPS002	SAPS	09/07/2017 11:20	73.3678	18.91803				09/07/2017 13:07	73.36778	18.91801		C Vega	Deployment 1
22	B4	D1-01	Drone	09/07/2017 11:38	73.3678	18.91804				09/07/2017 11:40	73.3678	18.91804		M Porter	Flight 1
23	B4	D2-01	Drone	09/07/2017 11:49	73.36777	18.918				09/07/2017 12:06	73.36781	18.91801		M Porter	Flight 1
24	B4	SUCS001	SUCS	09/07/2017 13:17	73.3678	18.91804				09/07/2017 13:22	73.36808	18.91937		D Barnes	Deployment 1, failed
25	B4	SUCS002	SUCS	09/07/2017 13:29	73.36781	18.91805	09/07/2017 13:40	73.3678	18.91805	09/07/2017 14:28	73.36831	18.92056	470	D Barnes	Deployment 2
26	B4	MC007	MultiCorer	09/07/2017 14:55	73.36826	18.92053	09/07/2017 15:11	73.36826	18.92052	09/07/2017 15:25	73.36825	18.92049	470	C Maerz	Deployment 1
27	B4	MC008	MultiCorer	09/07/2017 15:49	73.36844	18.92055	09/07/2017 15:59	73.36844	18.92055	09/07/2017 16:13	73.36843	18.92057	470	C Maerz	Deployment 2
28	B4	MC009	MultiCorer	09/07/2017 16:30	73.36843	18.92119	09/07/2017 16:41	73.36843	18.92117	09/07/2017 16:55	73.36844	18.92114	470	C Maerz	Deployment 3
29	B4	D1-02	Drone	09/07/2017 17:11	73.36843	18.92117				09/07/2017 17:14	73.36843	18.92118		M Porter	Flight 1
30	B4	ZP008	ZooNet	09/07/2017 21:00	73.36846	18.92088	09/07/2017 21:10	73.36845	18.92088	09/07/2017 21:23	73.36847	18.92088		S Reed	Deployment 1, 200m deep
31	B4	ZP009	ZooNet	09/07/2017 21:29	73.36846	18.92085	09/07/2017 21:41	73.36848	18.92085	09/07/2017 21:55	73.36846	18.92083		S Reed	Deployment 2, 200m deep
32	B6	CTD004	CTD	10/07/2017 09:02	75.18323	17.5334	10/07/2017 09:07	75.18323	17.5334	10/07/2017 09:27	75.18322	17.5334	141	E Dummont	
33	B6	ZP010	ZooNet	10/07/2017 09:38	75.18324	17.53337				10/07/2017 09:40	75.18323	17.53337	140	S Reed	Deployment 1, failed
34	B6	ZP011	ZooNet	10/07/2017 09:43	75.18323	17.53334	10/07/2017 09:49	75.18322	17.53335	10/07/2017 09:58	75.18323	17.53334	140	S Reed	Deployment 2, 130m deep
35	B6	ZP012	ZooNet	10/07/2017 10:09	75.18323	17.53336	10/07/2017 10:16	75.18322	17.53343	10/07/2017 10:23	75.18322	17.53345	140	S Reed	Deployment 3, 120m deep
36	B6	SAPS003	SAPS	10/07/2017 11:01	75.18323	17.53338				10/07/2017 12:42	75.18323	17.53336	140	C Vega	Deployment 1
37	B6	SUCS003	SUCS	10/07/2017 12:54	75.1832	17.53341	10/07/2017 12:58	75.18319	17.53348	10/07/2017 13:51	75.18351	17.53675	140	D Barnes	Deployment 1
38	B6	MC010	MultiCorer	10/07/2017 14:18	75.18353	17.53676	10/07/2017 14:23	75.18353	17.53675	10/07/2017 14:33	75.18353	17.53675	141	C Maerz	Deployment 1
39	B6	MC011	MultiCorer	10/07/2017 14:48	75.18354	17.53673	10/07/2017 14:53	75.18354	17.53673	10/07/2017 15:03	75.18354	17.53674	141	C Maerz	Deployment 2
40	B6	MC012	MultiCorer	10/07/2017 15:16	75.18352	17.53742	10/07/2017 15:21	75.18351	17.53743	10/07/2017 15:30	75.18352	17.53744	142	C Maerz	Deployment 3
41	B6	ZP013	ZooNet	10/07/2017 20:59	75.18348	17.5372	10/07/2017 21:04	75.18347	17.53721	10/07/2017 21:10	75.18348	17.53719		S Reed	Deployment 1, 120m deep
42	B6	ZP014	ZooNet	10/07/2017 21:18	75.18348	17.5372	10/07/2017 21:23	75.18349	17.53718	10/07/2017 21:30	75.18349	17.53719		S Reed	Deployment 2, 120m deep
43	B7	DG004	Day Grab	11/07/2017 03:05	76.00029	16.83322	11/07/2017 03:12	76.00029	16.83324	11/07/2017 03:24	76.00029	16.83325	320	C Maerz	Deployment 1
44	B7	MC013	MultiCorer	11/07/2017 03:45	76.0003	16.83328	11/07/2017 03:53	76.00028	16.83322	11/07/2017 04:05	76.0003	16.83329	320	C Maerz	Deployment 1
45	B7	MC014	MultiCorer	11/07/2017 04:18	76.0003	16.83401	11/07/2017 04:27	76.00031	16.83403	11/07/2017 04:37	76.00032	16.83407	318	C Maerz	Deployment 2
46	B7	MC015	MultiCorer	11/07/2017 04:49	76.00031	16.83476	11/07/2017 04:57	76.0003	16.83479	11/07/2017 05:07	76.00031	16.83475	318	C Maerz	Deployment 3
47	B8	CTD005	CTD	11/07/2017 09:06	76.36643	16.6655	11/07/2017 09:12	76.36636	16.66394	11/07/2017 09:28	76.36592	16.65661	38	E Dummont	
48	B8	ZP015	ZooNet	11/07/2017 09:46	76.36589	16.65599	11/07/2017 09:49	76.36577	16.65272	11/07/2017 09:52	76.36622	16.6493	41	S Reed	Deployment 1, 30m deep
49	B8	ZP016	ZooNet	11/07/2017 09:55	76.36629	16.64909	11/07/2017 09:57	76.36667	16.64669	11/07/2017 09:59	76.36675	16.643	41	S Reed	Deployment 2, 28m deep
50	B8	SAPS004	SAPS	11/07/2017 10:36	76.36668	16.66686	11/07/2017 10:51	76.36668	16.6669	11/07/2017 12:09	76.36668	16.66684	41	C Vega	Deployment 1
51	B8	SUCS004	SUCS	11/07/2017 12:19	76.36667	16.66686				11/07/2017 12:49	76.36741	16.65239	41	D Barnes	Deployment 1
52	B7	CTD006	CTD	11/07/2017 15:29	76.00014	16.83257	11/07/2017 15:38	76.00013	16.83258	11/07/2017 16:07	76.00013	16.83262	319	E Dummont	Deployment 1
53	B21	CTD007	CTD	11/07/2017 18:30	76.00017	15.49816	11/07/2017 18:41	76.00018	15.49824	11/07/2017 19:07	76.00018	15.49824	366	E Dummont	Deployment 1

EVENT	STATION	ID	TYPE	START (deployed)			AT BOTTOM			END (on deck)			WDEPTH	PERSON	COMMENTS
				DATE	LATITUDE	LONGITUDE	DATE	LATITUDE	LONGITUDE	DATE	LATITUDE	LONGITUDE			
54	B9	MC016	MultiCorer	11/07/2017 22:18	76.00112	13.66654	11/07/2017 22:38	76.00054	13.66648	11/07/2017 23:01	76.00055	13.66652	1023	C Maerz	Deployment 1
55	B9	MC017	MultiCorer	11/07/2017 23:13	76.00072	13.66656	11/07/2017 23:33	76.00071	13.66653	11/07/2017 23:57	76.00071	13.66652	1021	C Maerz	Deployment 2
56	B9	MC018	MultiCorer	12/07/2017 00:10	76.00071	13.66729	12/07/2017 00:31	76.00072	13.66726	12/07/2017 00:54	76.00071	13.66726	1028	C Maerz	Deployment 3
57	B10	CTD008	CTD	12/07/2017 07:06	76.00014	10.66701	12/07/2017 07:14	76.00015	10.667	12/07/2017 07:39	76.00015	10.66693	2260	E Dummont	Deployment 1
58	B10	CTD009	CTD	12/07/2017 08:31	76.00012	10.667	12/07/2017 09:16	76.00015	10.66699	12/07/2017 10:21	76.00014	10.66703	2260	E Dummont	Deployment 2
59	B10	ZP017	ZooNet	12/07/2017 10:33	76.00014	10.66702	12/07/2017 10:46	76.00015	10.66697	12/07/2017 10:59	76.00015	10.66695	2260	S Reed	Deployment 1, 120m deep
60	B10	ZP018	ZooNet	12/07/2017 11:01	76.00014	10.66694	12/07/2017 11:14	76.00014	10.66701	12/07/2017 11:28	76.00013	10.66703	2260	S Reed	Deployment 2, 120m deep
61	B10	SAPS005	SAPS	12/07/2017 12:11	76.00015	10.66695				12/07/2017 13:51	76.00014	10.66701		C Vega	Deployment 1
62	B10	MC019	MultiCorer	12/07/2017 14:09	76.00013	10.66697	12/07/2017 14:52	76.00014	10.66696	12/07/2017 15:38	76.00015	10.66697	2260	C Maerz	
63	B10	MC020	MultiCorer	12/07/2017 15:51	76.00032	10.66705	12/07/2017 16:34	76.00031	10.66707	12/07/2017 17:21	76.00032	10.66699	2260	C Maerz	
64	B10	MC021	MultiCorer	12/07/2017 17:31	76.00032	10.6678	12/07/2017 18:15	76.00031	10.66782	12/07/2017 18:17	76.00032	10.66783	2259	C Maerz	
65	B10	ZP019	ZooNet	12/07/2017 21:00	76.00032	10.66777	12/07/2017 21:11	76.00031	10.66776	12/07/2017 21:20	76.00031	10.6678		S Reed	Deployment 1, 200m deep
66	B10	ZP020	ZooNet	12/07/2017 21:24	76.00033	10.6678	12/07/2017 21:34	76.00033	10.66779	12/07/2017 21:45	76.00031	10.66776		S Reed	Deployment 2, 200m deep
67	B19	CTD010	CTD	13/07/2017 01:04	76.00011	12.49981	13/07/2017 01:39	76.00009	12.49989	13/07/2017 02:34	76.00014	12.5	1716	E Dummont	
68	B9	CTD011	CTD	13/07/2017 07:01	75.99999	13.66688	13/07/2017 07:24	76	13.66686	13/07/2017 08:16	75.99998	13.66686	1028	E Dummont	Deployment 1
69	B9	CTD012	CTD	13/07/2017 09:19	75.99996	13.66673	13/07/2017 09:28	75.99997	13.66679	13/07/2017 09:44	75.99998	13.66674	1028	E Dummont	Deployment 2, 200m deep
70	B9	ZP021	ZooNet	13/07/2017 09:53	75.99996	13.66676	13/07/2017 10:03	75.99996	13.66677	13/07/2017 10:15	75.99995	13.66679		S Reed	Deployment 1, 200m deep
71	B9	ZP022	ZooNet	13/07/2017 10:18	75.99995	13.66683				13/07/2017 10:20	75.99994	13.66683		S Reed	Deployment 2, aborted as lack of temp probe attached to it
72	B9	ZP023	ZooNet	13/07/2017 10:22	75.99994	13.66679	13/07/2017 10:33	75.99995	13.66674	13/07/2017 10:45	75.99997	13.66679		S Reed	Deployment 3, 200m deep
73	B9	SAPS006	SAPS	13/07/2017 11:20	75.99995	13.66684				13/07/2017 13:04	75.99995	13.66676		C Vega	Deployment 1
74	B20	CTD013	CTD	13/07/2017 14:31	76.00027	14.49999	13/07/2017 14:42	76.00027	14.49996	13/07/2017 15:12	76.00025	14.49994	320	E Dummont	Deployment 1
75	B20	SUCS005	SUCS	13/07/2017 15:23	76.00026	14.49994	13/07/2017 15:53	76.00026	14.49997	13/07/2017 16:32	76.00379	14.51862	319	D Barnes	Deployment 1
76	B9	ZP024	ZooNet	13/07/2017 20:59	76.00013	13.66665				13/07/2017 21:18	75.99999	13.67288		S Reed	Deployment 1, 200m deep
77	B9	ZP025	ZooNet	13/07/2017 21:22	75.99998	13.67412				13/07/2017 21:39	75.99978	13.68175		S Reed	Deployment 2, 200m deep
78	B11	CTD014	CTD	14/07/2017 09:02	76.36613	21.00187	14/07/2017 09:11	76.36611	21.00195	14/07/2017 09:35	76.36612	21.00188	227	E Dummont	Deployment 1
79	B11	ZP026	ZooNet	14/07/2017 09:45	76.36612	21.0018				14/07/2017 10:07	76.36454	21.00195	227	S Reed	Deployment 1, 200m deep
80	B11	ZP027	ZooNet	14/07/2017 10:11	76.36419	21.00198				14/07/2017 10:30	76.36252	21.00191	227	S Reed	Deployment 2, 200m deep
81	B11	SAPS007	SAPS	14/07/2017 11:17	76.36641	20.99995				14/07/2017 12:51	76.36644	20.99994	228	C Vega	Deployment 1
82	B11	SUCS006	SUCS	14/07/2017 13:03	76.36643	21.00003				14/07/2017 13:04	76.36643	21.00002	228	D Barnes	Deployment 1, aborted due to problem with sheave
83	B11	SUCS007	SUCS	14/07/2017 13:06	76.36641	21.00005	14/07/2017 13:16	76.36643	20.99986	14/07/2017 14:14	76.36626	20.99622	228	D Barnes	Deployment 2
84	B11	MC022	MultiCorer	14/07/2017 14:37	76.36627	20.99626	14/07/2017 14:45	76.36627	20.99621	14/07/2017 14:57	76.36626	20.99618	228	C Maerz	Deployment 1
85	B11	MC023	MultiCorer	14/07/2017 15:08	76.36625	20.99622	14/07/2017 15:16	76.36626	20.9963	14/07/2017 15:27	76.36625	20.99621	228	C Maerz	Deployment 2
86	B11	MC024	MultiCorer	14/07/2017 15:37	76.36625	20.99706	14/07/2017 15:45	76.36626	20.99707	14/07/2017 15:55	76.36624	20.997	227	C Maerz	Deployment 3
87	B22	CTD015	CTD	14/07/2017 18:13	76.20001	21.83397	14/07/2017 18:19	76.20002	21.83396	14/07/2017 18:35	76.20002	21.83401	103	E Dummont	Deployment 1
88	B11	ZP028	ZooNet	14/07/2017 21:01	76.36616	21.00077				14/07/2017 21:21	76.36458	21.00079		S Reed	Deployment 1
89	B11	ZP029	ZooNet	14/07/2017 21:25	76.36432	21.00079				14/07/2017 21:47	76.36251	21.00092		S Reed	Deployment 2
90	B12	CTD016	CTD	15/07/2017 07:03	75.50024	26.00177	15/07/2017 07:09	75.50025	26.00174	15/07/2017 07:30	75.50025	26.00175	135	E Dummont	Deployment 1
91	B12	ZP030	ZooNet	15/07/2017 07:41	75.50025	26.00173				15/07/2017 07:54	75.49863	26.00555	130	S Reed	Deployment 1
92	B12	ZP031	ZooNet	15/07/2017 07:59	75.49813	26.00666				15/07/2017 08:12	75.4966	26.01032	130	S Reed	Deployment 2
93	B12	SAPS008	SAPS	15/07/2017 08:38	75.49529	26.01327				15/07/2017 08:42	75.4953	26.01329	130	C Vega	Deployment 1, aborted due to problem with winch
94	B12	SUCS008	SUCS	15/07/2017 10:45	75.49529	26.01332	15/07/2017 10:50	75.49518	26.01331	15/07/2017 11:27	75.49521	26.00988		D Barnes	Deployment 1
95	B12	SAPS009	SAPS	15/07/2017 12:18	75.50194	26.04358				15/07/2017 13:44	75.50195	26.04368		C Vega	Deployment 2
96	B13	ZP032	ZooNet	15/07/2017 22:29	74.49999	30.00002				15/07/2017 22:50	74.49999	30.00011		S Reed	Deployment 1
97	B13	ZP033	ZooNet	15/07/2017 22:55	74.49999	30.00012				15/07/2017 23:13	74.5	30.0001		S Reed	Deployment 2
98	B13	DG005	Day Grab	15/07/2017 23:32	74.50087	30.00354	15/07/2017 23:46	74.50089	30.00349	16/07/2017 00:02	74.5009	30.00357	358	C Maerz	Deployment 1, empty
99	B13	DG006	Day Grab	16/07/2017 00:06	74.5009	30.00354	16/07/2017 00:19	74.5009	30.00353	16/07/2017 00:35	74.50089	30.00348	358	C Maerz	Deployment 2, empty
100	B13	SUCS009	SUCS	16/07/2017 00:58	74.50089	30.00357	16/07/2017 01:07	74.50089	30.00354	16/07/2017 02:24	74.49909	29.99685		D Barnes	Deployment 1
101	B13	MC025	MultiCorer	16/07/2017 03:14	74.49997	30.00015	16/07/2017 03:24	74.49997	30.00012	16/07/2017 03:38	74.49999	30.00016	358	C Maerz	Deployment 1
102	B13	MC026	MultiCorer	16/07/2017 04:04	74.49996	30.00081	16/07/2017 04:15	74.49996	30.00085	16/07/2017 04:28	74.49997	30.00089	358	C Maerz	Deployment 2
103	B13	MC027	MultiCorer	16/07/2017 04:48	74.49978	30.00089	16/07/2017 04:59	74.49978	30.00085	16/07/2017 05:12	74.49978	30.00083	358	C Maerz	Deployment 3
104	B13	MC028	MultiCorer	16/07/2017 05:26	74.49977	30.00018	16/07/2017 05:36	74.49978	30.00015	16/07/2017 05:50	74.49978	30.00023	359	C Maerz	Deployment 4
105	B13	CTD017	CTD	16/07/2017 09:00	74.46659	30.0003	16/07/2017 09:09	74.46658	30.00028	16/07/2017 09:33	74.46657	30.00027	355	E Dummont	Deployment 1
106	B13	ZP034	ZooNet	16/07/2017 09:50	74.46658	30.00051				16/07/2017 10:09	74.46658	30.00049		S Reed	Deployment 1, 200m deep

EVENT	STATION	ID	TYPE	START (deployed)			AT BOTTOM			END (on deck)			WDEPTH	PERSON	COMMENTS
				DATE	LATITUDE	LONGITUDE	DATE	LATITUDE	LONGITUDE	DATE	LATITUDE	LONGITUDE			
107	B13	ZP035	ZooNet	16/07/2017 10:14	74.46658	30.00046				16/07/2017 10:36	74.4666	30.00044		S Reed	Deployment 2, 200m deep
108	B13	SAPS010	SAPS	16/07/2017 11:19	74.46651	30.00166				16/07/2017 12:45	74.46651	30.00163		C Vega	Deployment 1
109	B13	SUCS010	SUCS	16/07/2017 13:24	74.49906	30.00407	16/07/2017 13:36	74.49906	30.00406	16/07/2017 13:36	74.49906	30.00406		D Barnes	Deployment 1, deployed in position 4
110	B13	SUCS011	SUCS	16/07/2017 15:11	74.50025	29.99898	16/07/2017 15:11	74.50025	29.99898	16/07/2017 16:05	74.50101	29.99638	359	D Barnes	Deployment 2, deployed between position 3 and 2
111	B13	SMBA001	SMBA	16/07/2017 16:33	74.49994	29.99997	16/07/2017 16:33	74.49994	29.99997	16/07/2017 16:54	74.49996	29.99993	359	C Maerz	Deployment 1, deployed at position 3
112	B13	SMBA002	SMBA	16/07/2017 17:04	74.49995	30.00067	16/07/2017 17:12	74.49996	30.00068	16/07/2017 17:24	74.49996	30.00069	359	S Widdicombe	Deployment 2, 20m East
113	B13	SMBA003	SMBA	16/07/2017 17:31	74.49977	30.00065	16/07/2017 17:39	74.49976	30.00067	16/07/2017 17:49	74.49976	30.00066	359	S Widdicombe	Deployment 3, 20m East
114	B13	SMBA004	SMBA	16/07/2017 17:55	74.49976	29.99999	16/07/2017 18:04	74.49977	29.99997	16/07/2017 18:14	74.49977	29.99998	359	S Widdicombe	Deployment 4, 20m South
115	B13	SMBA005	SMBA	16/07/2017 18:20	74.49978	29.99932	16/07/2017 18:31	74.49976	29.99935	16/07/2017 18:42	74.49977	29.99937	359	S Widdicombe	Deployment 5, 20m West
116	B13	USNL001	USNL	16/07/2017 20:02	74.49996	29.99932	16/07/2017 20:12	74.49995	29.9993	16/07/2017 20:25	74.49995	29.99935	364	J Nunes	Deployment 1
117	B13	USNL002	USNL	16/07/2017 20:35	74.50013	29.99936	16/07/2017 20:45	74.50013	29.99933	16/07/2017 20:57	74.50012	29.99934	365	J Nunes	Deployment 2
118	B13	USNL003	USNL	16/07/2017 21:06	74.50014	29.99998	16/07/2017 21:16	74.50014	29.99999	16/07/2017 21:28	74.50013	29.99996	366	J Nunes	Deployment 3
119	B13	USNL004	USNL	16/07/2017 21:38	74.50013	30.00064	16/07/2017 21:47	74.50012	30.00066	16/07/2017 21:59	74.50013	30.00066	366	J Nunes	Deployment 4
120	B13	USNL005	USNL	16/07/2017 22:07	74.50013	30.00135	16/07/2017 22:18	74.50013	30.00135	16/07/2017 22:29	74.500117	30.0013667	363	Laura/Dan	Deployment 5
121	B13	USNL006	USNL	16/07/2017 22:38	74.50013	30.00201	16/07/2017 22:48	74.50012	30.00206	16/07/2017 22:59	74.50012	30.00202	363	Laura/Dan	Deployment 6
122	B13	USNL007	USNL	16/07/2017 23:06	74.49995	30.00198	16/07/2017 23:17	74.49994	30.00202	16/07/2017 23:28	74.499933	30.0020333	364	Laura/Dan	Deployment 7
123	B13	USNL008	USNL	16/07/2017 23:37	74.499767	30.00215	16/07/2017 23:46	74.49978	30.0023	16/07/2017 23:58	74.49961	30.00224	365	Laura/Dan	Deployment 8
124	B13	USNL009	USNL	17/07/2017 00:07	74.49962	30.00226	17/07/2017 00:17	74.49961	30.00228	17/07/2017 00:28	74.49961	30.00225	365	Laura/Dan	Deployment 9
125	B13	USNL010	USNL	17/07/2017 00:38	74.49958	30.00098	17/07/2017 00:49	74.49961	30.00167	17/07/2017 00:59	74.49961	30.00162	365	Laura/Dan	Deployment 10
126	B13	USNL011	USNL	17/07/2017 01:08	74.49962	30.00106	17/07/2017 01:19	74.49959	30.00103	17/07/2017 01:30	74.4996	30.00103	383	S Widdicombe	Deployment 11
127	B13	USNL012	USNL	17/07/2017 01:40	74.4996	30.00029	17/07/2017 01:50	74.49961	30.00026	17/07/2017 02:01	74.49961	30.00025	366	S Widdicombe	Deployment 12
128	B13	USNL013	USNL	17/07/2017 02:09	74.49961	29.99958	17/07/2017 02:19	74.49963	29.99967	17/07/2017 02:31	74.4996	29.99956	359	S Widdicombe	Deployment 13
129	B13	USNL014	USNL	17/07/2017 02:40	74.4996	29.99886	17/07/2017 02:40	74.4996	29.99886	17/07/2017 03:01	74.49958	29.99884	359	S Widdicombe	Deployment 14
130	B13	AGT001	AGT	17/07/2017 06:07	74.50912	29.98815				17/07/2017 06:10	74.50887	29.98838		D Barnes	Deployment 1, aborted
131	B13	AGT002	AGT	17/07/2017 06:46	74.50858	29.9887	17/07/2017 06:58	74.50763	29.98968	17/07/2017 07:25	74.50406	29.99338	350	D Barnes	Deployment 2
132	B13	AGT003	AGT	17/07/2017 08:02	74.51099	29.99806	17/07/2017 08:13	74.51007	29.99851	17/07/2017 08:38	74.50663	30.00023	350	D Barnes	Deployment 3
133	B13	AGT004	AGT	17/07/2017 08:55	74.49897	30.00356	17/07/2017 09:05	74.49817	30.00406	17/07/2017 09:31	74.4949	30.00635	360	S Widdicombe	Deployment 4
134	B13	AGT005	AGT	17/07/2017 09:58	74.50878	29.98888	17/07/2017 10:08	74.50799	29.98968	17/07/2017 10:43	74.50219	29.99543		S Widdicombe	Deployment 5
135	B13	AGT006	AGT	17/07/2017 11:00	74.50083	30.00348	17/07/2017 11:12	74.49983	30.00336	17/07/2017 11:47	74.49402	30.00338	359	S Widdicombe	Deployment 6
136	B13	AGT007	AGT	17/07/2017 11:56	74.49341	30.0034	17/07/2017 12:09	74.49235	30.00335	17/07/2017 12:42	74.48652	30.00349	360	S Widdicombe	Deployment 7
137	B13	AGT008	AGT	17/07/2017 13:07	74.49939	29.99641	17/07/2017 13:12	74.49899	29.9965	17/07/2017 13:53	74.49257	29.99644	363	S Widdicombe	Deployment 8
138	B13	Glider001	Glider	17/07/2017 14:55	74.46672	30.00044				17/07/2017 15:50	74.46358	30.0056		M Porter	Deployment 1
139	B13	CTD018	CTD	17/07/2017 16:06	74.46355	30.00564	17/07/2017 16:15	74.46354	30.00564	17/07/2017 16:34	74.46354	30.00559	356	E Dummont	Deployment 1
140	B15	ZP036	ZooNet	18/07/2017 20:56	78.25003	30.00008	18/07/2017 21:06	78.25003	30.00007	18/07/2017 21:20	78.25002	30.00003	315	S Reed	Deployment 1, 200 m depth
141	B15	ZP037	ZooNet	18/07/2017 21:24	78.25003	30.00008	18/07/2017 21:32	78.25002	30.00007	18/07/2017 21:50	78.25001	30.00007	315	S Reed	Deployment 2, 200m depth
142	B15	SUCS012	SUCS	18/07/2017 22:37	78.25084	30.00473	19/07/2017 00:09	78.2526	30.0095	19/07/2017 00:16	78.2526	30.00957	316	D Barnes	Deployment 1
143	B15	SUCS013	SUCS	19/07/2017 00:37	78.25079	30.00936	19/07/2017 00:45	78.25079	30.00936	19/07/2017 02:13	78.25276	30.01172	316	D Barnes	Deployment 2
144	B15	MC029	MultiCorer	19/07/2017 02:57	78.25169	30.00901	19/07/2017 03:07	78.25169	30.00909	19/07/2017 03:19	78.25168	30.00907	316	C Maerz	Deployment 1
145	B15	MC030	MultiCorer	19/07/2017 03:37	78.2515	30.00921	19/07/2017 03:46	78.2515	30.00907	19/07/2017 03:57	78.2515	30.00945	316	C Maerz	Deployment 2
146	B15	MC031	MultiCorer	19/07/2017 04:25	78.25149	30.00848	19/07/2017 04:33	78.25152	30.00849	19/07/2017 04:45	78.25151	30.00841	316	C Maerz	Deployment 3
147	B15	CTD019	CTD	19/07/2017 09:30	78.21435	30.00075	19/07/2017 09:39	78.21432	30.00084	19/07/2017 10:01	78.21433	30.00089	330	E Dummont	Deployment 1
148	B15	ZP038	ZooNet	19/07/2017 10:14	78.21433	30.0009	19/07/2017 10:22	78.21433	30.00088	19/07/2017 10:30	78.21433	30.00094		S Reed	Deployment 1, 200 m depth
149	B15	ZP039	ZooNet	19/07/2017 10:36	78.2143	30.00085	19/07/2017 10:45	78.21429	30.00084	19/07/2017 10:55	78.21429	30.00086		S Reed	Deployment 2, 200m depth
150	B15	SAPS011	SAPS	19/07/2017 11:46	78.21426	30.00082				19/07/2017 13:18	78.21426	30.00076	331	C Vega	Deployment 1
151	B15	SMBA006	SMBA	19/07/2017 14:24	78.25171	30.00924	19/07/2017 14:32	78.2517	30.00916	19/07/2017 14:43	78.25171	30.00917	317	S Widdicombe	Deployment 1
152	B15	SMBA007	SMBA	19/07/2017 14:53	78.25171	30.01013	19/07/2017 15:00	78.25172	30.01014	19/07/2017 15:10	78.25171	30.01017	316	S Widdicombe	Deployment 2
153	B15	SMBA008	SMBA	19/07/2017 15:17	78.25154	30.01019	19/07/2017 15:24	78.25154	30.01024	19/07/2017 15:34	78.25153	30.01025	316	S Widdicombe	Deployment 3
154	B15	SMBA009	SMBA	19/07/2017 15:42	78.25154	30.00932	19/07/2017 15:48	78.25153	30.00938	19/07/2017 15:57	78.25155	30.00929	316	S Widdicombe	Deployment 4
155	B15	SMBA010	SMBA	19/07/2017 16:05	78.25156	30.00844	19/07/2017 16:12	78.25156	30.00844	19/07/2017 16:21	78.25153	30.00844	316	S Widdicombe	Deployment 5
156	B15	USNL015	USNL	19/07/2017 18:12	78.25168	30.00852	19/07/2017 18:22	78.2517	30.00842	19/07/2017 18:33	78.25169	30.00849	318	J Nunes	Deployment 1
157	B15	USNL016	USNL	19/07/2017 18:41	78.25188	30.0085	19/07/2017 18:50	78.25187	30.00846	19/07/2017 19:01	78.25188	30.00855	315	J Nunes	Deployment 2
158	B15	USNL017	USNL	19/07/2017 19:20	78.25187	30.00928	19/07/2017 19:29	78.25187	30.00938	19/07/2017 19:39	78.25189	30.0093	316	J Nunes	Deployment 3
159	B15	USNL018	USNL	19/07/2017 19:47	78.25188	30.01024	19/07/2017 19:55	78.25189	30.01023	19/07/2017 20:06	78.25189	30.01024	315	J Nunes	Deployment 4

EVENT	STATION	ID	TYPE	START (deployed)			AT BOTTOM			END (on deck)			WDEPTH	PERSON	COMMENTS
				DATE	LATITUDE	LONGITUDE	DATE	LATITUDE	LONGITUDE	DATE	LATITUDE	LONGITUDE			
160	B15	USNL019	USNL	19/07/2017 20:13	78.25188	30.01109	19/07/2017 20:23	78.25188	30.01112	19/07/2017 20:33	78.25188	30.0111	313	Laura/Dan	Deployment 5, failed, corer did not close
161	B15	USNL020	USNL	19/07/2017 20:40	78.25189	30.0112	19/07/2017 20:50	78.25189	30.0112	19/07/2017 21:01	78.2519	30.0112	316	Laura/Dan	Deployment 6
162	B15	USNL021	USNL	19/07/2017 21:09	78.25172	30.01113	19/07/2017 21:18	78.25157	30.01133	19/07/2017 21:30	78.2517	30.01125	318	Laura/Dan	Deployment 7
163	B15	USNL022	USNL	19/07/2017 21:39	78.25151	30.01127	19/07/2017 21:48	78.25154	30.01127	19/07/2017 21:58	78.25153	30.01124	317	Laura/Dan	Deployment 8
164	B15	USNL023	USNL	19/07/2017 22:07	78.25136	30.01126	19/07/2017 22:15	78.25134	30.01129	19/07/2017 22:26	78.25133	30.01133	315	Laura/Dan	Deployment 9
165	B15	USNL024	USNL	19/07/2017 22:35	78.25134	30.01048	19/07/2017 22:44	78.25132	30.01046	19/07/2017 22:54	78.25132	30.0105	316	Laura/Dan	Deployment 10
166	B15	USNL025	USNL	19/07/2017 23:01	78.25134	30.00988	19/07/2017 23:12	78.25132	30.00959	19/07/2017 23:21	78.25133	30.00957	315	S Widdicombe	Deployment 11
167	B15	USNL026	USNL	19/07/2017 23:29	78.25133	30.00876	19/07/2017 23:37	78.25132	30.0093	19/07/2017 23:48	78.2513	30.00867	317	S Widdicombe	Deployment 12
168	B15	USNL027	USNL	19/07/2017 23:56	78.25132	30.00786	20/07/2017 00:06	78.25167	30.00786	20/07/2017 00:16	78.25129	30.0077	318	S Widdicombe	Deployment 13
169	B15	USNL028	USNL	20/07/2017 00:24	78.25146	30.00772	20/07/2017 00:35	78.25148	30.00776	20/07/2017 00:43	78.25148	30.0078	305	S Widdicombe	Deployment 14
170	B15	USNL029	USNL	20/07/2017 01:01	78.25167	30.00779	20/07/2017 01:10	78.25164	30.0077	20/07/2017 01:20	78.25162	30.00777	319	S Widdicombe	Deployment 15
171	B15	AGT009	AGT	20/07/2017 03:22	78.25661	29.99363	20/07/2017 03:33	78.25584	29.99617	20/07/2017 04:02	78.25303	30.00699	316	D Barnes	Deployment 1
172	B15	AGT010	AGT	20/07/2017 04:31	78.25281	30.00638	20/07/2017 04:43	78.25197	30.00382	20/07/2017 05:14	78.24889	29.99315	315	D Barnes	Deployment 2
173	B15	AGT011	AGT	20/07/2017 05:51	78.25306	30.03419	20/07/2017 06:02	78.25293	30.02975	20/07/2017 06:26	78.25301	30.01424	316	D Barnes	Deployment 3
174	B15	AGT012	AGT	20/07/2017 07:07	78.25199	30.04306	20/07/2017 07:16	78.25192	30.03949	20/07/2017 07:49	78.25277	30.0117	317	D Barnes	Deployment 4
175	B15	AGT013	AGT	20/07/2017 08:06	78.2529	30.01066	20/07/2017 08:14	78.25338	30.00846	20/07/2017 08:48	78.2583	29.99185	317	S Widdicombe	Deployment 5, failed
176	B15	AGT014	AGT	20/07/2017 08:49	78.25835	29.99169	20/07/2017 08:58	78.259	29.98976	20/07/2017 09:31	78.26423	29.97687	317	S Widdicombe	Deployment 6
177	B15	AGT015	AGT	20/07/2017 09:49	78.26433	29.97651	20/07/2017 09:58	78.26497	29.9747	20/07/2017 10:30	78.27064	29.97054	317	S Widdicombe	Deployment 7
178	B16	SUCS014	SUCS	21/07/2017 15:33	80.09382	29.93495	21/07/2017 15:40	80.09382	29.93493	21/07/2017 16:02	80.09423	29.93397	301	D Barnes	Deployment 1, started at position 5
179	B16	SUCS015	SUCS	21/07/2017 17:09	80.11371	29.93498	21/07/2017 17:16	80.1137	29.93496	21/07/2017 18:13	80.11424	29.93211	316	D Barnes	Deployment 2, started at position 2
180	B16	SUCS016	SUCS	21/07/2017 20:14	80.1148	30.02454	21/07/2017 20:20	80.11546	30.02461	21/07/2017 20:46	80.1174	30.02974		D Barnes	Deployment 3
181	B16	ZP040	ZooNet	21/07/2017 20:58	80.11791	30.0357	21/07/2017 21:06	80.11826	30.04028	21/07/2017 21:19	80.1189	30.04789		S Reed	Deployment 1, 200m depth
182	B16	ZP041	ZooNet	21/07/2017 21:24	80.11915	30.05116	21/07/2017 21:32	80.11939	30.05231	21/07/2017 21:50	80.11947	30.05755		S Reed	Deployment 2, 200m depth
183	B16	MC032	MultiCorer	21/07/2017 22:21	80.11966	30.06681	21/07/2017 22:33	80.11921	30.06782	21/07/2017 22:42	80.1192	30.06891	287	C Maerz	Deployment 1
184	B16	MC033	MultiCorer	21/07/2017 23:07	80.11788	30.07359	21/07/2017 23:17	80.11689	30.07467	21/07/2017 23:27	80.11568	30.07396	279	C Maerz	Deployment 2
185	B16	MC034	MultiCorer	21/07/2017 23:49	80.11232	30.06521	22/07/2017 00:00	80.11083	30.05988	22/07/2017 00:09	80.10931	30.05687	282	C Maerz	Deployment 3
186	B16	CTD020	CTD	22/07/2017 08:02	80.15129	29.91463	22/07/2017 08:11	80.1535	29.91866	22/07/2017 08:30	80.15792	29.92957	294	E Dummont	Deployment 1
187	B16	ZP042	ZooNet	22/07/2017 08:41	80.16026	29.93854				22/07/2017 08:59	80.16332	29.95099		S Reed	Deployment 1, 200m depth
188	B16	ZP043	ZooNet	22/07/2017 09:07	80.16349	29.95601				22/07/2017 09:22	80.16652	29.96144		S Reed	Deployment 2, 200m depth
189	B16	SAPS012	SAPS	22/07/2017 09:46	80.17146	29.98054				22/07/2017 11:18	80.18298	30.05224		C Vega	Deployment 1
190	B16	SMBA011	SMBA	22/07/2017 13:06	80.08924	29.9896	22/07/2017 13:15	80.08941	29.98845	22/07/2017 13:23	80.08909	29.98936	303	S Widdicombe	Deployment 1
191	B16	SMBA012	SMBA	22/07/2017 13:30	80.08875	29.99147	22/07/2017 13:38	80.08798	29.99636	22/07/2017 13:46	80.08713	29.99962	300	S Widdicombe	Deployment 2
192	B16	SMBA013	SMBA	22/07/2017 14:10	80.09499	29.99721	22/07/2017 14:17	80.09472	29.9966	22/07/2017 14:25	80.09435	29.99642	294	S Widdicombe	Deployment 3
193	B16	SMBA014	SMBA	22/07/2017 14:33	80.09464	29.99708	22/07/2017 14:39	80.09463	29.99673	22/07/2017 14:47	80.09466	29.99765	295	S Widdicombe	Deployment 4
194	B16	SMBA015	SMBA	22/07/2017 14:55	80.09458	29.99691	22/07/2017 15:00	80.09465	29.99654	22/07/2017 15:09	80.09461	29.99569	293	S Widdicombe	Deployment 5
195	B16	USNL030	USNL	22/07/2017 17:28	80.10668	29.9934	22/07/2017 17:36	80.10729	29.99521	22/07/2017 17:45	80.10742	29.99723	292	J Nunes	Deployment 1
196	B16	USNL031	USNL	22/07/2017 17:52	80.10742	29.99883	22/07/2017 17:59	80.10744	29.99882	22/07/2017 18:09	80.10765	29.99984	293	J Nunes	Deployment 2, failed, corer did not close
197	B16	USNL032	USNL	22/07/2017 18:12	80.10765	29.99994	22/07/2017 18:20	80.10753	30.0028	22/07/2017 18:31	80.10813	30.00469	291	J Nunes	Deployment 3
198	B16	USNL033	USNL	22/07/2017 18:40	80.10797	30.01619	22/07/2017 18:48	80.10849	30.02079	22/07/2017 18:58	80.10924	30.02155	291	J Nunes	Deployment 4
199	B16	USNL034	USNL	22/07/2017 19:06	80.10983	30.02289	22/07/2017 19:13	80.11037	30.02702	22/07/2017 19:24	80.11092	30.03088	286	J Nunes	Deployment 5
200	B16	USNL035	USNL	22/07/2017 19:34	80.10971	30.0305	22/07/2017 19:42	80.11071	30.03578	22/07/2017 19:52	80.11185	30.03821	286	Laura/Dan	Deployment 6
201	B16	USNL036	USNL	22/07/2017 20:05	80.11539	30.05614	22/07/2017 20:13	80.11678	30.06457	22/07/2017 20:23	80.11809	30.07151	281	Laura/Dan	Deployment 7
202	B16	USNL037	USNL	22/07/2017 21:15	80.10477	30.01418	22/07/2017 21:24	80.1054	30.016	22/07/2017 21:34	80.10607	30.0229	296	Laura/Dan	Deployment 8
203	B16	USNL038	USNL	22/07/2017 21:40	80.10667	30.02982	22/07/2017 21:50	80.10758	30.03939	22/07/2017 22:00	80.10843	30.04166	288	Laura/Dan	Deployment 9
204	B16	USNL039	USNL	22/07/2017 22:08	80.10832	30.04561	22/07/2017 22:17	80.10951	30.05529	22/07/2017 22:27	80.09719	30.034	283	Laura/Dan	Deployment 10, not suitable for sampling
205	B16	USNL040	USNL	22/07/2017 22:34	80.11058	30.07171	22/07/2017 22:43	80.11099	30.07918	22/07/2017 22:52	80.11112	30.07986	280	Laura/Dan	Deployment 11
206	B16	USNL041	USNL	22/07/2017 23:00	80.11266	30.09258	22/07/2017 23:09	80.09727	30.03908	22/07/2017 23:19	80.09725	30.03938	278	Laura/Dan	Deployment 12
207	B16	USNL042	USNL	23/07/2017 00:15	80.09725	30.03951	23/07/2017 00:24	80.09681	30.04685	23/07/2017 00:35	80.09594	30.05413	280	S Widdicombe	Deployment 13
208	B16	USNL043	USNL	23/07/2017 00:41	80.09572	30.06103	23/07/2017 00:50	80.09498	30.06532	23/07/2017 01:00	80.09435	30.06863	287	S Widdicombe	Deployment 14
209	B16	USNL044	USNL	23/07/2017 01:05	80.09398	30.06995	23/07/2017 01:16	80.09219	30.07344	23/07/2017 01:27	80.09079	30.08013	280	S Widdicombe	Deployment 15
210	B16	USNL045	USNL	23/07/2017 01:34	80.08971	30.09042	23/07/2017 01:43	80.08823	30.09933	23/07/2017 01:55	80.0872	30.107	277	S Widdicombe	Deployment 16
211	B16	AGT016	AGT	23/07/2017 04:14	80.08577	30.04994	23/07/2017 04:26	80.08477	30.05032	23/07/2017 05:05	80.07939	30.04921	285	D Barnes	Deployment 1
212	B16	AGT017	AGT	23/07/2017 05:30	80.07514	30.04944	23/07/2017 05:40	80.07432	30.04951	23/07/2017 06:06	80.07065	30.05098	287	D Barnes	Deployment 2

EVENT	STATION	ID	TYPE	START (deployed)			AT BOTTOM			END (on deck)			WDEPTH	PERSON	COMMENTS
				DATE	LATITUDE	LONGITUDE	DATE	LATITUDE	LONGITUDE	DATE	LATITUDE	LONGITUDE			
213	B16	AGT018	AGT	23/07/2017 06:24	80.06756	30.05252	23/07/2017 06:31	80.06702	30.05266	23/07/2017 06:54	80.06385	30.05067	282	D Barnes	Deployment 3, failed, cable caught around frame
214	B16	AGT019	AGT	23/07/2017 06:59	80.06636	30.04955	23/07/2017 07:06	80.06634	30.04644	23/07/2017 07:27	80.06238	30.03046	296	D Barnes	Deployment 4, failed, empty trawl
215	B16	AGT020	AGT	23/07/2017 07:30	80.06235	30.02993	23/07/2017 07:37	80.06229	30.02669	23/07/2017 07:57	80.06227	30.0098	291	D Barnes	Deployment 5, failed, empty trawl
215B	B16	AGT021	AGT	23/07/2017 08:09	80.06177	30.03437	23/07/2017 08:17	80.06197	30.03068	23/07/2017 08:48	80.06418	30.01102	295	D Barnes	Deployment 6
216	B16	AGT022	AGT	23/07/2017 09:12	80.05737	30.03752	23/07/2017 09:20	80.05801	30.0368	23/07/2017 09:52	80.06377	30.02923	285	S Widdicombe	Deployment 7
217	B16	AGT023	AGT	23/07/2017 10:16	80.06373	30.03105	23/07/2017 10:23	80.06328	30.03177	23/07/2017 10:56	80.058705	30.0568333	286	S Widdicombe	Deployment 8
218	B16	AGT024	AGT	23/07/2017 11:20	80.067183	30.0609833	23/07/2017 11:31	80.066333	30.0613	23/07/2017 12:02	80.0609	30.0868	280	S Widdicombe	Deployment 9
219	B17	SUCS017	SUCS	24/07/2017 11:08	81.32379	29.23146				24/07/2017 11:27	81.32156	29.24752		D Barnes	Deployment 1
220	B17	SUCS018	SUCS	24/07/2017 11:39	81.31726	29.27033	24/07/2017 11:47	81.31725	29.27046	24/07/2017 12:03	81.31592	29.27357	318	D Barnes	Deployment 2
221	B17	SUCS019	SUCS	24/07/2017 12:12	81.31081	29.3044	24/07/2017 12:20	81.31014	29.30501	24/07/2017 12:40	81.30848	29.30684	318	D Barnes	Deployment 3
222	B17	SUCS020	SUCS	24/07/2017 12:49	81.30829	29.30727	24/07/2017 12:56	81.30233	29.33122	24/07/2017 13:20	81.3005	29.32666	324	D Barnes	Deployment 4
223	B17	MC035	MultiCorer	24/07/2017 13:48	81.28959	29.34096	24/07/2017 13:57	81.2882	29.34052	24/07/2017 14:08	81.28682	29.33602	335	C Maerz	Deployment 1
224	B17	MC036	MultiCorer	24/07/2017 14:21	81.28411	29.33417	24/07/2017 14:28	81.28317	29.33261	24/07/2017 14:38	81.28169	29.3281	340	C Maerz	Deployment 2, corers not suitable for sampling
225	B17	MC037	MultiCorer	24/07/2017 14:46	81.28001	29.32743	24/07/2017 14:53	81.27942	29.32454	24/07/2017 15:03	81.27878	29.3176	339	C Maerz	Deployment 3
226	B17	MC038	MultiCorer	24/07/2017 15:18	81.27572	29.3045	24/07/2017 15:26	81.2752	29.30726	24/07/2017 15:36	81.27562	29.30272	340	C Maerz	Deployment 4
227	B17	USNL046	USNL	24/07/2017 16:25	81.27498	29.26483	24/07/2017 16:57	81.27642	29.24559	24/07/2017 17:08	81.27718	29.24204	335	Laura/Dan	Deployment 1
228	B17	USNL047	USNL	24/07/2017 16:50	81.27631	29.24851	24/07/2017 16:57	81.27642	29.24559	24/07/2017 17:08	81.27718	29.24204	335	Laura/Dan	Deployment 2
229	B17	USNL048	USNL	24/07/2017 17:15	81.27857	29.23777	24/07/2017 17:23	81.27892	29.23538	24/07/2017 17:34	81.27973	29.23408	332	Laura/Dan	Deployment 3
230	B17	USNL049	USNL	24/07/2017 17:42	81.28175	29.23316	24/07/2017 17:50	81.28249	29.23142	24/07/2017 18:00	81.28316	29.23008	326	Laura/Dan	Deployment 4
231	B17	ZP044	ZooNet	24/07/2017 21:00	81.40979	29.28084	24/07/2017 21:12	81.41031	29.29119	24/07/2017 21:25	81.41098	29.30497		S Reed	Deployment 1, 200m depth
232	B17	ZP045	ZooNet	24/07/2017 21:32	81.41073	29.31287	24/07/2017 21:44	81.41019	29.32527	24/07/2017 21:59	81.40939	29.34109		S Reed	Deployment 2, 200m depth
233	B24	CTD021	CTD	25/07/2017 01:46	81.50801	29.7714	25/07/2017 02:10	81.50768	29.773	25/07/2017 02:41	81.50813	29.7792	891	E Dummont	Deployment 1
234	B23	CTD022	CTD	25/07/2017 04:10	81.45889	29.98468	25/07/2017 04:21	81.45937	29.98613	25/07/2017 04:40	81.46049	29.99097	402	E Dummont	Deployment 1
235	B17	CTD023	CTD	25/07/2017 08:00	81.40167	29.50329	25/07/2017 08:08	81.40201	29.5129	25/07/2017 08:28	81.40385	29.53629	291	E Dummont	Deployment 1
236	B17	ZP046	ZooNet	25/07/2017 08:40	81.40473	29.55042	25/07/2017 08:49	81.40502	29.562	25/07/2017 08:57	81.40533	29.57141		S Reed	Deployment 1, 200m depth
237	B17	ZP047	ZooNet	25/07/2017 09:01	81.40554	29.57458	25/07/2017 09:07	81.40565	29.58051	25/07/2017 09:15	81.40587	29.59046		S Reed	Deployment 2, 200m depth
238	B17	SAPS013	SAPS	25/07/2017 09:46	81.40632	29.63408				25/07/2017 11:20	81.39988	29.73493		C Vega	Deployment 1
239	B17	AGT025	AGT	25/07/2017 11:45	81.41268	29.73425	25/07/2017 11:54	81.41705	29.71927	25/07/2017 12:19	81.41355	29.73633	292	D Barnes	Deployment 1
240	B17	AGT026	AGT	25/07/2017 12:36	81.41234	29.73249	25/07/2017 12:43	81.41068	29.73657	25/07/2017 13:05	81.40691	29.74556	292	D Barnes	Deployment 2
241	B17	AGT027	AGT	25/07/2017 13:26	81.40811	29.73751	25/07/2017 13:42	81.4044	29.7419	25/07/2017 13:55	81.40242	29.74426	289	D Barnes	Deployment 3
242	B17	AGT028	AGT	25/07/2017 14:14	81.40292	29.74332	25/07/2017 15:21	81.39267	29.72785	25/07/2017 15:52	81.39183	29.6925	292	S Widdicombe	Deployment 4
243	B17	AGT029	AGT	25/07/2017 15:13	81.39403	29.73898	25/07/2017 15:21	81.39267	29.72785	25/07/2017 15:52	81.39183	29.6925	292	S Widdicombe	Deployment 5
244	B17	AGT030	AGT	25/07/2017 16:58	81.39175	29.68623	25/07/2017 17:06	81.39324	29.68275	25/07/2017 17:40	81.3989	29.68091	294	S Widdicombe	Deployment 6
245	B25	CTD024	CTD	26/07/2017 04:09	81.5644	29.77187	26/07/2017 04:38	81.5638	29.79891	26/07/2017 05:22	81.56331	29.83992	1513	E Dummont	Deployment 1
246	B26	CTD025	CTD	26/07/2017 06:39	81.61559	29.48487	26/07/2017 07:16	81.61565	29.51471	26/07/2017 08:05	81.61659	29.57743	2037	E Dummont	Deployment 1
247	B18	CTD026	CTD	26/07/2017 11:03	81.72591	29.86762	26/07/2017 11:12	81.72595	29.86737	26/07/2017 11:22	81.72633	29.868	2798	E Dummont	Deployment 1, 200m depth
248	B18	CTD027	CTD	26/07/2017 12:00	81.7273	29.868	26/07/2017 12:57	81.72911	29.85705	26/07/2017 14:02	81.73253	29.8527	2814	E Dummont	Deployment 2
249	B18	ZP048	ZooNet	26/07/2017 14:16	81.73398	29.85354	26/07/2017 14:22	81.73451	29.85398	26/07/2017 14:33	81.73514	29.85583		S Reed	Deployment 1, 200m depth
250	B18	SAPS014	SAPS	26/07/2017 15:20	81.74062	29.87156				26/07/2017 16:42	81.75104	29.93592		C Vega	Deployment 1
251	B18	MC039	MultiCorer	26/07/2017 16:57	81.75291	29.95377	26/07/2017 18:03	81.7583	30.01445	26/07/2017 19:01	81.76304	30.07612	2936	C Maerz	Deployment 1
252	B18	MC040	MultiCorer	26/07/2017 19:17	81.76402	30.0899	26/07/2017 20:27	81.76756	30.14322	26/07/2017 21:31	81.77033	30.18277	3005	C Maerz	Deployment 2
253	B18	ZP049	ZooNet	26/07/2017 22:09	81.77227	30.20858	26/07/2017 22:21	81.77244	30.2161	26/07/2017 22:35	81.77228	30.22352		S Reed	Deployment 1, 200m depth
254	B17	SMBA016	SMBA	27/07/2017 07:41	81.3978	29.90427	27/07/2017 07:48	81.39842	29.9101	27/07/2017 07:55	81.39901	29.91465	263	S Widdicombe	Deployment 1, failed, not suitable for sampling
255	B17	SMBA017	SMBA	27/07/2017 09:52	81.34501	29.53986	27/07/2017 09:58	81.34628	29.54535	27/07/2017 10:07	81.34759	29.54802	305	S Widdicombe	Deployment 2
256	B17	SMBA018	SMBA	27/07/2017 10:12	81.34854	29.55106	27/07/2017 10:19	81.34965	29.55796	27/07/2017 10:28	81.35086	29.56603	302	S Widdicombe	Deployment 3
257	B17	SMBA019	SMBA	27/07/2017 10:33	81.35221	29.57247	27/07/2017 10:40	81.35283	29.57981	27/07/2017 10:47	81.35292	29.58484	304	S Widdicombe	Deployment 4
258	B17	SMBA020	SMBA	27/07/2017 10:51	81.3534	29.58838	27/07/2017 10:58	81.35425	29.59553	27/07/2017 11:07	81.35471	29.60248	302	S Widdicombe	Deployment 5
259	B17	SMBA021	SMBA	27/07/2017 11:09	81.35454	29.60245	27/07/2017 11:16	81.35515	29.60419	27/07/2017 11:24	81.35655	29.61354	300	S Widdicombe	Deployment 6, failed, no sample
260	B17	SMBA022	SMBA	27/07/2017 11:27	81.35687	29.61642	27/07/2017 11:32	81.35691	29.6238	27/07/2017 11:40	81.35737	29.62995	299	S Widdicombe	Deployment 7
261	B17	USNL050	USNL	27/07/2017 12:03	81.36009	29.66925	27/07/2017 12:11	81.35993	29.67644	27/07/2017 12:19	81.36013	29.68243	299	S Widdicombe	Deployment 1, failed, not suitable for sampling
262	B17	USNL051	USNL	27/07/2017 12:26	81.36033	29.69216	27/07/2017 12:33	81.36005	29.7006	27/07/2017 12:41	81.35994	29.70539	288	S Widdicombe	Deployment 2, failed, corer empty
263	B17	USNL052	USNL	27/07/2017 14:14	81.29906	29.20067	27/07/2017 14:21	81.29814	29.207	27/07/2017 14:30	81.29705	29.21222	316	S Widdicombe	Deployment 3, failed, not suitable for sampling
264	B17	USNL053	USNL	27/07/2017 14:38	81.29611	29.22044	27/07/2017 14:45	81.29535	29.22545	27/07/2017 14:54	81.29417	29.22841	317	S Widdicombe	Deployment 4

EVENT	STATION	ID	TYPE	START (deployed)			AT BOTTOM			END (on deck)			WDEPTH	PERSON	COMMENTS
				DATE	LATITUDE	LONGITUDE	DATE	LATITUDE	LONGITUDE	DATE	LATITUDE	LONGITUDE			
265	B17	USNL054	USNL	27/07/2017 14:59	81.29316	29.23196	27/07/2017 15:06	81.29195	29.23512	27/07/2017 15:14	81.29092	29.23501	320	S Widdicombe	Deployment 5
266	B17	USNL055	USNL	27/07/2017 15:21	81.28966	29.23919	27/07/2017 15:29	81.28886	29.24253	27/07/2017 15:38	81.28778	29.24442	320	S Widdicombe	Deployment 6, failed, not suitable for sampling
267	B17	USNL056	USNL	27/07/2017 15:45	81.28505	29.23879	27/07/2017 15:53	81.28435	29.24127	27/07/2017 16:01	81.28364	29.24424	320	S Widdicombe	Deployment 7, failed, no sample
268	B17	USNL057	USNL	27/07/2017 16:03	81.28338	29.24504	27/07/2017 16:11	81.28255	29.24505	27/07/2017 16:20	81.28133	29.24255	324	S Widdicombe	Deployment 8, failed, no sample
269	B17	USNL058	USNL	27/07/2017 16:58	81.30992	29.14457	27/07/2017 17:05	81.30925	29.14042	27/07/2017 17:13	81.30857	29.13866	308	S Widdicombe	Deployment 9
270	B17	USNL059	USNL	27/07/2017 17:21	81.30767	29.13233	27/07/2017 17:28	81.30724	29.12756	27/07/2017 17:35	81.3065	29.12354	302	S Widdicombe	Deployment 10
271	B17	USNL060	USNL	27/07/2017 17:42	81.30577	29.11806	27/07/2017 17:49	81.30528	29.1135	27/07/2017 17:57	81.30494	29.10711	307	S Widdicombe	Deployment 11
272	B18	USNL061	USNL	27/07/2017 18:07	81.30422	29.09509	27/07/2017 18:16	81.30374	29.08633	27/07/2017 18:27	81.30331	29.07851	310	J Nunes	Deployment 12
273	B19	USNL062	USNL	27/07/2017 18:38	81.30287	29.07027	27/07/2017 18:47	81.30311	29.06479	27/07/2017 18:58	81.30372	29.05855	312	J Nunes	Deployment 13, failed
274	B20	USNL063	USNL	27/07/2017 19:08	81.30433	29.04815	27/07/2017 19:18	81.30471	29.0407	27/07/2017 19:29	81.30513	29.03226	321	J Nunes	Deployment 14
275	B21	USNL064	USNL	27/07/2017 19:38	81.30591	29.02173	27/07/2017 19:48	81.30673	29.01353	27/07/2017 19:57	81.30745	29.00752	315	J Nunes	Deployment 15
276	B22	SUCS021	SUCS	27/07/2017 20:30	81.31155	28.97494	27/07/2017 20:38	81.31257	28.9669	27/07/2017 20:57	81.31465	28.95817	304	D Barnes	Deployment 1
277	B27	CTD028	CTD	28/07/2017 01:46	80.99141	29.30963	28/07/2017 01:59	80.99118	29.31261	28/07/2017 02:19	80.98876	29.32892	391	E Dummont	Deployment 1
278	B28	CTD029	CTD	28/07/2017 05:32	80.6705	29.29392	28/07/2017 05:43	80.66952	29.29513	28/07/2017 06:05	80.66619	29.2988	426	E Dummont	Deployment 1
279	B16	CTD030	CTD	28/07/2017 11:19	80.10056	30.00426	28/07/2017 11:27	80.10153	30.00185	28/07/2017 11:46	80.10399	29.99515	293	E Dummont	Deployment 1
280	B29	CTD031	CTD	28/07/2017 15:52	79.66658	28.66588	28/07/2017 16:00	79.66658	28.66513	28/07/2017 16:14	79.66655	28.66434	269	E Dummont	Deployment 1
281	B30	CTD032	CTD	28/07/2017 19:28	79.33842	27.49934	28/07/2017 19:38	79.33841	27.49927	28/07/2017 19:58	79.33783	27.49758	325	E Dummont	Deployment 1
282	B31	CTD033	CTD	28/07/2017 23:14	79.1118	25.71455	28/07/2017 23:22	79.11191	25.7158	28/07/2017 23:38	79.11143	25.71263	222	E Dummont	Deployment 1
283	B32	CTD034	CTD	29/07/2017 03:49	78.83445	23.83999	29/07/2017 03:56	78.83446	23.83981	29/07/2017 04:09	78.83446	23.83995	172	E Dummont	Deployment 1
284	B33	CTD035	CTD	29/07/2017 07:47	78.36647	26.16955	29/07/2017 07:54	78.36648	26.16953	29/07/2017 08:09	78.36644	26.16959	248	E Dummont	Deployment 1
285	B15	CTD036	CTD	29/07/2017 13:19	78.25026	30.00729	29/07/2017 13:27	78.25026	30.00744	29/07/2017 13:41	78.25021	30.00738	316	E Dummont	Deployment 1
286	B15	USNL065	USNL	29/07/2017 14:07	78.25024	30.00224	29/07/2017 14:14	78.25026	30.00207	29/07/2017 14:21	78.25027	30.00235	314	Laura/Dan	Deployment 1
287	B15	USNL066	USNL	29/07/2017 14:27	78.2503	30.00245	29/07/2017 14:34	78.25015	30.00227	29/07/2017 14:42	78.25014	30.00221	313	Laura/Dan	Deployment 2
288	B15	USNL067	USNL	29/07/2017 14:47	78.25011	30.00224	29/07/2017 14:54	78.25004	30.00212	29/07/2017 15:02	78.25004	30.00203	313	Laura/Dan	Deployment 3
289	B15	USNL068	USNL	29/07/2017 15:07	78.25004	30.00206	29/07/2017 15:14	78.24998	30.00209	29/07/2017 15:21	78.24997	30.00201	313	Laura/Dan	Deployment 4
290	B34	CTD037	CTD	29/07/2017 20:39	77.33284	29.99885	29/07/2017 20:46	77.33285	29.99893	29/07/2017 21:01	77.33283	29.99929	185	E Dummont	Deployment 1
291	B14	SUCS022	SUCS	30/07/2017 01:45	76.49908	30.50308				30/07/2017 04:47	76.49909	30.49725		D Barnes	Deployment 1
292	B14	MC041	MultiCorer	30/07/2017 05:23	76.49909	30.49731	30/07/2017 05:32	76.49907	30.49736	30/07/2017 05:43	76.49908	30.49737	293	C Maerz	Deployment 1
293	B14	MC042	MultiCorer	30/07/2017 06:06	76.50088	30.49636	30/07/2017 06:13	76.50086	30.49638	30/07/2017 06:23	76.50087	30.49641	296	C Maerz	Deployment 2, failed
294	B14	MC043	MultiCorer	30/07/2017 06:31	76.50088	30.49634	30/07/2017 06:39	76.50084	30.49658	30/07/2017 06:50	76.50089	30.49645	296	C Maerz	Deployment 3
295	B14	MC044	MultiCorer	30/07/2017 07:10	76.50094	30.50417	30/07/2017 07:17	76.50091	30.50405	30/07/2017 07:27	76.50095	30.50411	296	C Maerz	Deployment 4
296	B14	CTD038	CTD	30/07/2017 09:00	76.49941	30.28704	30/07/2017 09:08	76.49943	30.28726	30/07/2017 09:30	76.49943	30.2872	290	E Dummont	Deployment 1
297	B14	ZP050	ZooNet	30/07/2017 09:40	76.49941	30.28713	30/07/2017 09:47	76.49942	30.28706	30/07/2017 09:56	76.49942	30.28715		S Reed	Deployment 1, 200m depth
298	B14	ZP051	ZooNet	30/07/2017 09:58	76.4994	30.28714	30/07/2017 10:05	76.49942	30.28734	30/07/2017 10:12	76.49945	30.28716		S Reed	Deployment 2, 200m depth
299	B14	SAPS015	SAPS	30/07/2017 11:14	76.49941	30.28693				30/07/2017 12:36	76.49942	30.28698		C Vega	Deployment 1
300	B14	AGT031	AGT	30/07/2017 13:13	76.49844	30.49471	30/07/2017 13:25	76.49922	30.4947	30/07/2017 13:48	76.50228	30.49473	293	D Barnes	Deployment 1
301	B14	AGT032	AGT	30/07/2017 14:02	76.50056	30.49465	30/07/2017 14:11	76.50124	30.49459	30/07/2017 14:35	76.50411	30.49472	297	D Barnes	Deployment 2, failed as cable was wrapped around trawl frame
302	B14	AGT033	AGT	30/07/2017 14:40	76.50324	30.49463	30/07/2017 14:48	76.5039	30.49459	30/07/2017 15:08	76.50677	30.49477	295	D Barnes	Deployment 3
303	B14	AGT034	AGT	30/07/2017 15:35	76.50041	30.50556	30/07/2017 15:43	76.50104	30.50552	30/07/2017 16:04	76.50407	30.50566	294	D Barnes	Deployment 4
304	B14	AGT035	AGT	30/07/2017 16:19	76.50414	30.50576	30/07/2017 16:27	76.50484	30.50562	30/07/2017 16:50	76.50841	30.50559	293	D Barnes	Deployment 5
305	B14	AGT036	AGT	30/07/2017 17:15	76.50107	30.50413	30/07/2017 17:22	76.50167	30.50409	30/07/2017 17:55	76.50791	30.50407	293	S Widdicombe	Deployment 6
306	B14	AGT037	AGT	30/07/2017 18:28	76.50093	30.49784	30/07/2017 18:40	76.50219	30.49867	30/07/2017 19:17	76.50875	30.50312	296	S Widdicombe	Deployment 7
307	B14	AGT038	AGT	30/07/2017 19:50	76.49884	30.49658	30/07/2017 20:01	76.50005	30.49825	30/07/2017 20:39	76.50677	30.50739	293	S Widdicombe	Deployment 8
308	B14	ZP052	ZooNet	30/07/2017 21:44	76.49958	30.42373	30/07/2017 21:56	76.49958	30.42383	30/07/2017 22:10	76.49957	30.42374		S Reed	Deployment 1, 200m depth
309	B14	ZP053	ZooNet	30/07/2017 22:13	76.49962	30.42378	30/07/2017 22:26	76.49962	30.42385	30/07/2017 22:43	76.49962	30.42383		S Reed	Deployment 2, 200m depth
310	B14	SMBA023	SMBA	30/07/2017 23:12	76.50009	30.49999	30/07/2017 23:21	76.5001	30.50009	30/07/2017 23:30	76.50011	30.50001	293	S Widdicombe	Deployment 1
311	B14	SMBA024	SMBA	30/07/2017 23:40	76.50014	30.50088	30/07/2017 23:51	76.50012	30.50104	31/07/2017 00:00	76.50014	30.50088	293	S Widdicombe	Deployment 2
312	B14	SMBA025	SMBA	31/07/2017 00:04	76.49995	30.50077	31/07/2017 00:14	76.49995	30.50094	31/07/2017 00:23	76.49991	30.50083	293	S Widdicombe	Deployment 3
313	B14	SMBA026	SMBA	31/07/2017 00:31	76.49994	30.50013	31/07/2017 00:42	76.49992	30.50033	31/07/2017 00:51	76.49995	30.50017	293	S Widdicombe	Deployment 4
314	B14	SMBA027	SMBA	31/07/2017 00:56	76.49996	30.49943	31/07/2017 01:06	76.49997	30.49943	31/07/2017 01:16	76.49993	30.49945	293	S Widdicombe	Deployment 5
315	B14	USNL069	USNL	31/07/2017 01:41	76.5001	30.49941	31/07/2017 01:51	76.5001	30.4993	31/07/2017 02:01	76.50011	30.49925	293	J Nunes	Deployment 1
316	B14	USNL070	USNL	31/07/2017 02:08	76.50034	30.49935	31/07/2017 02:16	76.50036	30.49919	31/07/2017 02:27	76.5003	30.49927	294	J Nunes	Deployment 2
317	B14	USNL071	USNL	31/07/2017 02:36	76.50036	30.50013	31/07/2017 02:44	76.50033	30.5	31/07/2017 02:54	76.50029	30.50003	294	J Nunes	Deployment 3

EVENT	STATION	ID	TYPE	START (deployed)			AT BOTTOM			END (on deck)			WDEPTH	PERSON	COMMENTS
				DATE	LATITUDE	LONGITUDE	DATE	LATITUDE	LONGITUDE	DATE	LATITUDE	LONGITUDE			
318	B14	USNL072	USNL	31/07/2017 03:00	76.50033	30.50078	31/07/2017 03:08	76.50033	30.5009	31/07/2017 03:18	76.50031	30.501	293	Laura/Dan	Deployment 4
319	B14	USNL073	USNL	31/07/2017 03:25	76.5003	30.50168	31/07/2017 03:34	76.5003	30.50174	31/07/2017 03:44	76.50032	30.50175	293	Laura/Dan	Deployment 5
320	B14	USNL074	USNL	31/07/2017 03:54	76.50011	30.50189	31/07/2017 04:02	76.50014	30.50173	31/07/2017 04:12	76.50012	30.5017	294	Laura/Dan	Deployment 6
321	B14	USNL075	USNL	31/07/2017 04:19	76.49996	30.50165	31/07/2017 04:27	76.49993	30.50174	31/07/2017 04:38	76.49993	30.50178	294	Laura/Dan	Deployment 7
322	B14	USNL076	USNL	31/07/2017 06:07	76.49977	30.50178	31/07/2017 06:13	76.49977	30.50188	31/07/2017 06:20	76.49975	30.50195	295	S Widdicombe	Deployment 8
323	B14	USNL077	USNL	31/07/2017 06:28	76.49978	30.50096	31/07/2017 06:35	76.49979	30.50102	31/07/2017 06:43	76.49975	30.50106	296	S Widdicombe	Deployment 9
324	B14	USNL078	USNL	31/07/2017 06:49	76.49973	30.50019	31/07/2017 06:55	76.49974	30.50038	31/07/2017 07:02	76.49974	30.50027	295	S Widdicombe	Deployment 10
325	B14	USNL079	USNL	31/07/2017 07:11	76.49978	30.49957	31/07/2017 07:17	76.49977	30.49957	31/07/2017 07:25	76.49977	30.49965	296	S Widdicombe	Deployment 11
326	B14	USNL080	USNL	31/07/2017 07:31	76.49977	30.49864	31/07/2017 07:39	76.49978	30.4986	31/07/2017 07:46	76.49977	30.49877	295	S Widdicombe	Deployment 12
327	B14	CTD039	CTD	31/07/2017 11:04	76.44628	29.32717	31/07/2017 11:11	76.44625	29.32721	31/07/2017 11:19	76.44625	29.32727	243	E Dummont	Deployment 1
328	B14	Glider001	Glider	31/07/2017 14:11	76.45909	29.35727				31/07/2017 14:28	76.46713	29.32702		M Porter	Recovery
329	B35	CTD040	CTD	31/07/2017 19:38	75.49944	30.00071	31/07/2017 19:49	75.49945	30.00065	31/07/2017 20:07	75.49942	30.0006	348	E Dummont	Deployment 1
330	B13	CTD041	CTD	01/08/2017 01:27	74.49984	29.9982	01/08/2017 01:36	74.49996	29.99984	01/08/2017 01:54	74.5	29.9997	346	E Dummont	Deployment 1
331	B13	USNL081	USNL	01/08/2017 02:29	74.50006	29.99962	01/08/2017 02:38	74.49999	29.99977	01/08/2017 02:50	74.50001	29.9998	359	Laura/Dan	Deployment 1
332	B13	USNL082	USNL	01/08/2017 02:57	74.50021	29.99964	01/08/2017 03:06	74.50018	29.99978	01/08/2017 03:17	74.50019	29.9997	359	Laura/Dan	Deployment 2
333	B13	USNL083	USNL	01/08/2017 03:24	74.50018	30.00039	01/08/2017 03:33	74.50019	30.00041	01/08/2017 03:45	74.5002	30.00045	359	Laura/Dan	Deployment 3
334	B13	USNL084	USNL	01/08/2017 03:54	74.50002	30.00054	01/08/2017 04:03	74.50003	30.00036	01/08/2017 04:15	74.50005	30.00032	358	Laura/Dan	Deployment 4
335	B13	SMBA028	SMBA	01/08/2017 06:10	74.49987	30.00039	01/08/2017 06:17	74.49984	30.00031	01/08/2017 06:26	74.49984	30.00039	261	Laura/Dan	Deployment 1
336	B13	SMBA029	SMBA	01/08/2017 06:35	74.49983	29.99971	01/08/2017 06:43	74.49984	29.9996	01/08/2017 06:51	74.49985	29.99969	361	Laura/Dan	Deployment 2
337	B13	SMBA030	SMBA	01/08/2017 06:54	74.49984	29.99963	01/08/2017 07:01	74.49984	29.99973	01/08/2017 07:10	74.49984	29.99974	362	Laura/Dan	Deployment 3
338	B13	SMBA031	SMBA	01/08/2017 07:12	74.49985	29.99964	01/08/2017 07:19	74.49982	29.99971	01/08/2017 07:27	74.49986	29.99967	362	Laura/Dan	Deployment 4
339	B13	SMBA032	SMBA	01/08/2017 07:30	74.49986	29.99969	01/08/2017 07:38	74.4999	29.99967	01/08/2017 07:46	74.49984	29.99977	360	Laura/Dan	Deployment 5
340	B13	SMBA033	SMBA	01/08/2017 07:50	74.49986	29.99972	01/08/2017 07:58	74.49987	29.99971	01/08/2017 08:06	74.49988	29.99974	362	Laura/Dan	Deployment 6
341	B13	SMBA034	SMBA	01/08/2017 08:08	74.49984	29.99976	01/08/2017 08:16	74.49984	29.99975	01/08/2017 08:24	74.49982	29.99972	362	Laura/Dan	Deployment 7
342	B13	SMBA035	SMBA	01/08/2017 08:26	74.49983	29.9997	01/08/2017 08:34	74.49984	29.99962	01/08/2017 08:43	74.49987	29.99971	363	Laura/Dan	Deployment 8
343	B13	SMBA036	SMBA	01/08/2017 08:51	74.49989	29.99907	01/08/2017 08:58	74.49991	29.99927	01/08/2017 09:06	74.49987	29.99911	363	Laura/Dan	Deployment 9
344	B13	SMBA037	SMBA	01/08/2017 09:09	74.49988	29.99914	01/08/2017 09:16	74.49992	29.99902	01/08/2017 09:25	74.49991	29.9992	363	Laura/Dan	Deployment 10
345	B13	AGT039	AGT	01/08/2017 10:08	74.50097	30.00846	01/08/2017 10:21	74.50106	30.00341	01/08/2017 10:45	74.50109	29.98928	362	Laura/Dan	Deployment 1, at position 1
346	B13	AGT040	AGT	01/08/2017 11:08	74.49902	30.00937	01/08/2017 11:19	74.49914	30.00637	01/08/2017 11:55	74.49918	29.98021	358	Laura/Dan	Deployment 2, at position 4
347	B13	AGT041	AGT	01/08/2017 12:11	74.49915	29.97964	01/08/2017 12:22	74.4992	29.97562	01/08/2017 12:57	74.49917	29.95057	363	Laura/Dan	Deployment 3
348	B13	AGT042	AGT	01/08/2017 13:25	74.49957	30.00736	01/08/2017 13:36	74.49919	30.0035	01/08/2017 14:11	74.49905	29.97931	358	Laura/Dan	Deployment 4
349	B36	CTD042	CTD	01/08/2017 18:50	75.09994	28.07047	01/08/2017 19:00	75.09992	28.07033	01/08/2017 19:16	75.09991	28.07029	329	E Dummont	Deployment 1
350	B12	CTD043	CTD	01/08/2017 23:07	75.49987	25.99929	01/08/2017 23:13	75.49986	25.99916	01/08/2017 23:22	75.49989	25.99931	135	E Dummont	Deployment 1
351	B37	CTD044	CTD	02/08/2017 03:25	75.94961	23.57826	02/08/2017 03:29	75.94961	23.57834	02/08/2017 03:38	75.94959	23.57829	54	E Dummont	Deployment 1
352	B11	CTD045	CTD	02/08/2017 07:43	76.36646	21.00042	02/08/2017 07:50	76.36647	21.00034	02/08/2017 08:02	76.36645	21.00033	228	E Dummont	Deployment 1
353	B38	CTD046	CTD	02/08/2017 11:05	76.18964	18.89318	02/08/2017 11:12	76.18968	18.89284	02/08/2017 11:28	76.18965	18.89292	236	E Dummont	Deployment 1
354	B8	CTD047	CTD	02/08/2017 16:55	76.36663	16.66614	02/08/2017 17:00	76.36665	16.66614	02/08/2017 17:05	76.36664	16.66621	41	E Dummont	Deployment 1
355	B7	ZP054	ZooNet	02/08/2017 20:56	76.00015	16.83291	02/08/2017 21:07	76.00018	16.83296	02/08/2017 21:22	76.00008	16.83283	319	S Reed	Deployment 1, 200m depth
356	B7	ZP055	ZooNet	02/08/2017 21:25	76.00011	16.83284	02/08/2017 21:39	76.00014	16.83287	02/08/2017 21:52	76.00013	16.83277	319	S Reed	Deployment 2, 200m depth
357	B7	CTD048	CTD	03/08/2017 08:59	76.00012	16.83357	03/08/2017 09:06	76.00016	16.83354	03/08/2017 09:26	76.00014	16.83363	319	E Dummont	Deployment 1
358	B7	ZP056	ZooNet	03/08/2017 09:34	76.00013	16.83364				03/08/2017 09:48	76.00012	16.83367	319	S Reed	Deployment 1, 200m depth
359	B7	ZP057	ZooNet	03/08/2017 09:52	76.00014	16.83373							319	S Reed	Deployment 2, 200m depth
360	B7	SAPS016	SAPS	03/08/2017 10:45	76.00017	16.83358				03/08/2017 12:24	76.00019	16.83362		C Vega	Deployment 1
361	B7	SUCS023	SUCS	03/08/2017 12:36	76.00018	16.83359	03/08/2017 12:46	76.00013	16.83391	03/08/2017 13:12	75.99995	16.83855	318	D Barnes	Deployment 1
362	B39	CTD049	CTD	03/08/2017 18:37	75.59161	17.19255	03/08/2017 18:44	75.5916	17.19254	03/08/2017 18:52	75.59158	17.19252	164	E Dummont	Deployment 1
363	B6	CTD050	CTD	03/08/2017 23:06	75.1843	17.53451	03/08/2017 23:12	75.18429	17.53448	03/08/2017 23:20	75.18431	17.53442	140	E Dummont	Deployment 1
364	B40	CTD051	CTD	04/08/2017 03:20	74.77496	17.8587	04/08/2017 03:28	74.77509	17.85899	04/08/2017 03:38	74.77514	17.85881	250	E Dummont	Deployment 1
365	B5	CTD052	CTD	04/08/2017 08:54	74.36649	18.16632	04/08/2017 09:02	74.36654	18.16638	04/08/2017 09:15	74.36646	18.16624	118	E Dummont	Deployment 1
366	B5	ZP058	ZooNet	04/08/2017 09:27	74.36644	18.16632				04/08/2017 09:37	74.36645	18.16628		S Reed	Deployment 1, 200m depth
367	B5	ZP059	ZooNet	04/08/2017 09:41	74.36651	18.16638				04/08/2017 09:50	74.3665	18.16623		S Reed	Deployment 2, 200m depth
368	B5	SAPS017	SAPS	04/08/2017 10:23	74.3665	18.16619				04/08/2017 12:14	74.3665	18.16624		C Vega	Deployment 1
369	B5	SUCS024	SUCS	04/08/2017 12:21	74.36648	18.16624	04/08/2017 12:24	74.3665	18.16619	04/08/2017 12:46	74.36544	18.16665	119	D Barnes	Deployment 1
370	B41	CTD053	CTD	04/08/2017 16:29	73.86652	18.54953	04/08/2017 16:34	73.86653	18.54942	04/08/2017 16:41	73.86652	18.54943	199	E Dummont	Deployment 1

EVENT	STATION	ID	TYPE	START (deployed)			AT BOTTOM			END (on deck)			WDEPTH	PERSON	COMMENTS
				DATE	LATITUDE	LONGITUDE	DATE	LATITUDE	LONGITUDE	DATE	LATITUDE	LONGITUDE			
371	B5	ZP060	ZooNet	04/08/2017 20:57	74.36696	18.16732	04/08/2017 21:02	74.36777	18.16868	04/08/2017 21:08	74.36909	18.17101	118	S Reed	Deployment 1, 90 m depth
372	B5	ZP061	ZooNet	04/08/2017 21:13	74.37001	18.17251	04/08/2017 21:19	74.37105	18.17425	04/08/2017 21:26	74.37226	18.17637	118	S Reed	Deployment 2, 90 m depth
373	B4	CTD054	CTD	05/08/2017 03:29	73.36639	18.91729	05/08/2017 03:41	73.36636	18.91725	05/08/2017 04:04	73.36637	18.91734	471	E Dummont	Deployment 1
374	B3	CTD055	CTD	05/08/2017 08:57	72.63304	19.25011	05/08/2017 09:06	72.63306	19.25015	05/08/2017 09:28	72.63309	19.25028	366	E Dummont	Deployment 1
375	B3	ZP062	ZooNet	05/08/2017 09:39	72.63309	19.25027	05/08/2017 09:47	72.63308	19.25029	05/08/2017 09:55	72.63311	19.25024		S Reed	Deployment 1, 200m depth
376	B3	ZP063	ZooNet	05/08/2017 09:57	72.63309	19.25024	05/08/2017 10:05	72.63312	19.25024	05/08/2017 10:12	72.63309	19.25021		S Reed	Deployment 2, 200m depth
377	B3	SAPS018	SAPS	05/08/2017 10:45	72.63314	19.25017				05/08/2017 12:30	72.63312	19.25025		C Vega	Deployment 1
378	B3	SUCS025	SUCS	05/08/2017 12:38	72.63323	19.24988				05/08/2017 14:47	72.63404	19.25251		D Barnes	Deployment 1
379	B3	MC045	MultiCorer	05/08/2017 15:26	72.63332	19.25003	05/08/2017 15:35	72.63333	19.25005	05/08/2017 15:46	72.63334	19.24998	369	C Maerz	Deployment 1
380	B3	MC046	MultiCorer	05/08/2017 16:12	72.63236	19.25311	05/08/2017 16:20	72.63238	19.25307	05/08/2017 16:31	72.63235	19.25304	368	C Maerz	Deployment 2
381	B3	MC047	MultiCorer	05/08/2017 16:53	72.63252	19.25311	05/08/2017 17:01	72.6325	19.25307	05/08/2017 17:11	72.63253	19.25308	367	C Maerz	Deployment 3
382	B3	MC048	MultiCorer	05/08/2017 17:29	72.63232	19.24694	05/08/2017 17:37	72.63235	19.24699	05/08/2017 17:48	72.63236	19.24709	370	C Maerz	Deployment 4
383	B3	ZP064	ZooNet	05/08/2017 20:56	72.64986	19.25121	05/08/2017 21:09	72.65079	19.25194	05/08/2017 21:22	72.65182	19.25283		S Reed	Deployment 1, 200m depth
384	B3	ZP065	ZooNet	05/08/2017 21:24	72.65198	19.25292	05/08/2017 21:37	72.65305	19.25385	05/08/2017 21:52	72.65426	19.25468		S Reed	Deployment 2, 200m depth
385	B3	SMBA038	SMBA	06/08/2017 02:00	72.63324	19.25025	06/08/2017 02:10	72.6333	19.25016	06/08/2017 02:22	72.6333	19.25012	368	S Widdicombe	Deployment 1
386	B3	SMBA039	SMBA	06/08/2017 02:25	72.6333	19.2501	06/08/2017 02:35	72.63309	19.25015	06/08/2017 02:47	72.63313	19.25012	369	S Widdicombe	Deployment 2
387	B3	SMBA040	SMBA	06/08/2017 02:50	72.63297	19.25014	06/08/2017 02:59	72.63292	19.24999	06/08/2017 03:11	72.63292	19.25008	368	S Widdicombe	Deployment 3
388	B3	SMBA041	SMBA	06/08/2017 03:14	72.63283	19.25011	06/08/2017 03:23	72.63277	19.25004	06/08/2017 03:35	72.63277	19.25	368	S Widdicombe	Deployment 4
389	B3	SMBA042	SMBA	06/08/2017 03:44	72.6326	19.25004	06/08/2017 03:53	72.63258	19.25012	06/08/2017 04:05	72.63259	19.25014	368	S Widdicombe	Deployment 5
390	B3	USNL085	USNL	06/08/2017 04:29	72.63261	19.24948	06/08/2017 04:38	72.63257	19.24953	06/08/2017 04:50	72.63253	19.24965	368	J Nunes	Deployment 1
391	B3	USNL086	USNL	06/08/2017 04:56	72.63271	19.24951	06/08/2017 05:06	72.63267	19.24968	06/08/2017 05:17	72.63274	19.24945	368	J Nunes	Deployment 2, failed, no sample
392	B3	USNL087	USNL	06/08/2017 05:19	72.63271	19.24953	06/08/2017 05:29	72.63273	19.24936	06/08/2017 05:40	72.63272	19.24958	368	J Nunes	Deployment 3
393	B3	USNL088	USNL	06/08/2017 05:46	72.63282	19.2495	06/08/2017 05:55	72.63289	19.24951	06/08/2017 06:06	72.63295	19.24953	368	J Nunes	Deployment 4
394	B3	USNL089	USNL	06/08/2017 06:13	72.63297	19.24936	06/08/2017 06:22	72.63313	19.24944	06/08/2017 06:31	72.63312	19.24944	372	S Widdicombe	Deployment 5
395	B3	USNL090	USNL	06/08/2017 06:37	72.63328	19.24951	06/08/2017 06:45	72.6333	19.24938	06/08/2017 06:53	72.6333	19.24949	373		Deployment 6
396	B3	USNL091	USNL	06/08/2017 07:02	72.6333	19.24881	06/08/2017 07:10	72.63332	19.24884	06/08/2017 07:19	72.63335	19.24883	371		Deployment 7
397	B3	USNL092	USNL	06/08/2017 07:27	72.63315	19.24884	06/08/2017 07:36	72.63311	19.24889	06/08/2017 07:45	72.63312	19.24897	371		Deployment 8, failed, no sample
398	B3	USNL093	USNL	06/08/2017 07:48	72.63307	19.24891	06/08/2017 07:56	72.63296	19.24889	06/08/2017 08:05	72.63295	19.24886	371		Deployment 9, failed, no sample
399	B3	USNL094	USNL	06/08/2017 08:06	72.63295	19.2489	06/08/2017 08:14	72.63296	19.24886	06/08/2017 08:23	72.63292	19.24879	371		Deployment 10
400	B3	USNL095	USNL	06/08/2017 08:28	72.63281	19.24878	06/08/2017 08:36	72.63274	19.24874	06/08/2017 08:45	72.63277	19.24899	371		Deployment 11
401	B3	AGT043	AGT	06/08/2017 09:52	72.6323	19.25357	06/08/2017 10:03	72.63209	19.25695	06/08/2017 10:29	72.6313	19.26925	364	D Barnes	Deployment 1
402	B3	AGT044	AGT	06/08/2017 10:50	72.63221	19.24704	06/08/2017 11:01	72.63203	19.25025	06/08/2017 11:24	72.63131	19.26169	368	D Barnes	Deployment 2
403	B3	AGT045	AGT	06/08/2017 11:45	72.63414	19.25288	06/08/2017 11:56	72.63399	19.256	06/08/2017 12:20	72.6334	19.26825	363	D Barnes	Deployment 3
404	B3	AGT046	AGT	06/08/2017 12:34	72.63338	19.26828	06/08/2017 12:45	72.63324	19.27167	06/08/2017 13:20	72.63238	19.29274	362	D Barnes	Deployment 4
405	B3	AGT047	AGT	06/08/2017 13:50	72.63221	19.24312	06/08/2017 14:01	72.63213	19.24663	06/08/2017 14:35	72.63179	19.26742	370	S Widdicombe	Deployment 5
406	B3	AGT048	AGT	06/08/2017 14:54	72.63239	19.25329	06/08/2017 15:04	72.63236	19.25666	06/08/2017 15:40	72.63211	19.27781	370	S Widdicombe	Deployment 6
407	B3	AGT049	AGT	06/08/2017 16:20	72.63414	19.25319	06/08/2017 16:29	72.63408	19.25588	06/08/2017 17:03	72.63385	19.27644	371	S Widdicombe	Deployment 7
408	B42	CTD056	CTD	06/08/2017 21:33	72.08317	19.50132	06/08/2017 21:42	72.0832	19.50131	06/08/2017 21:59	72.08319	19.50126	319	E Dummont	Deployment 1
409	B2	CTD057	CTD	07/08/2017 00:29	71.69976	19.66428	07/08/2017 00:37	71.69977	19.6643	07/08/2017 00:54	71.69976	19.6643	257	E Dummont	Deployment 1
410	B43	CTD058	CTD	07/08/2017 04:03	71.23305	19.83629	07/08/2017 04:10	71.23308	19.83624	07/08/2017 04:22	71.23308	19.83616	198	E Dummont	Deployment 1
411	B1	CTD059	CTD	07/08/2017 08:03	70.76672	19.99802	07/08/2017 08:08	70.76668	19.998	07/08/2017 08:20	70.76668	19.99794	190	E Dummont	Deployment 1
412	B1	ZP066	ZooNet	07/08/2017 08:32	70.76665	19.998	07/08/2017 08:38	70.76665	19.99789	07/08/2017 08:44	70.76665	19.998		S Reed	Deployment 1, 180 m depth
413	B1	ZP067	ZooNet	07/08/2017 08:49	70.76664	19.99799	07/08/2017 08:55	70.76666	19.99794	07/08/2017 09:03	70.76667	19.99793		S Reed	Deployment 2, 180 m depth
414	B1	SAPS019	SAPS	07/08/2017 09:24	70.76668	19.998				07/08/2017 11:04	70.76669	19.99793		C Vega	Deployment 1
415	B1	SUCS026	SUCS	07/08/2017 11:40	70.76665	19.99789	07/08/2017 11:43	70.76667	19.99787	07/08/2017 12:06	70.76589	20.0009		D Barnes	Deployment 1