



**National
Oceanography Centre**
NATURAL ENVIRONMENT RESEARCH COUNCIL

**National Oceanography Centre
Cruise Report No. 56
RRS *James Cook* Cruise JC166-167**

19 JUNE – 6 JULY 2018

CLASS – Climate-linked Atlantic System Science
Haig Fras Marine Conservation Zone AUV habitat monitoring,
Equipment trials and staff training

Principal Scientists
V A I Huvenne & M E Furlong

National Oceanography Centre, Southampton
University of Southampton Waterfront Campus
European Way
Southampton
Hants SO14 3ZH
UK

Tel: +44 (0)023 8059 6020
Fax: +44 (0)023 8059 6554
Email: vaih@noc.ac.uk

DOCUMENT DATA SHEET

AUTHOR HUVENNE, V.A.I. & FURLONG, M.	PUBLICATION DATE 2019
TITLE RRS <i>James Cook</i> Cruise 166-167, 19 June – 6 July 2018. Haig Fras Marine Conservation Zone AUV habitat monitoring, equipment trials and staff training	
REFERENCE Southampton, UK: National Oceanography Centre, Southampton, 152pp. (National Oceanography Centre Cruise Report, No. 56)	
ABSTRACT <p>Expedition JC166-167 combined a number of science and technical objectives in order to deliver a comprehensive programme for the UK marine science sector. The expedition supported the NERC National Capability programme CLASS (Climate-Linked Atlantic Sector Science, grant no NE/R015953/1), which aims to increase our understanding of the Atlantic Ocean system, in order to support evidence-based ocean management. More specifically, JC166-167 was part of the Fixed Point Observations Underpinning Activity, where repeated observations and surveys of Marine Protected Areas (MPAs) and their surroundings provide insight into the development and recovery of benthic ecosystems following natural and/or anthropogenic impacts.</p> <p>The target location for JC166-167 was the Greater Haig Fras Marine Conservation Zone (MCZ), west of Cornwall, which was surveyed by NOC, using Autosub AUVs, in 2012 and 2015. The 2018 expedition continued that time series, and expanded the study by also looking at differences in benthic community observed between day and night. Haig Fras is the only rocky reef on the Celtic Shelf, and was protected in 2016.</p> <p>In parallel with these science objectives, JC166-167 included an extensive series of equipment trials, combined with training for staff members of the Marine Autonomous and Robotic Systems group at NOC. The robotic and autonomous systems tested included the Isis ROV, HyBIS vehicle, the Autosub6000 AUV, a deep glider, a wave glider, a C-worker 4 USV and a drone. Some of the trials were carried out in the shallow waters around Haig Fras, while others required greater depths, for which we visited the Whittard Canyon system along the Celtic Margin. Wherever possible, trials and training were carried out in a way that the resulting data would help address CLASS science objectives, including objectives related to the sustained observations in the Canyons MCZ.</p> KEYWORDS Submarine canyon, cold-water corals, Marine Conservation Zone, Autonomous Underwater Vehicle, Remotely Operated Vehicle, Seaglider, Wave glider, habitat mapping.	
ISSUING ORGANISATION National Oceanography Centre University of Southampton Waterfront Campus European Way Southampton SO14 3ZH UK Tel: +44(0)23 80596116 Email: nol@noc.soton.ac.uk <i>A pdf of this report is available for download at: http://eprints.soton.ac.uk</i>	

(This page intentionally left blank)

<u>CONTENTS</u>	<u>PAGE</u>
SCIENTIFIC PERSONNEL	6
SHIPS OFFICERS AND CREW	6
ITINERARY	8
BACKGROUND AND SCIENTIFIC RATIONALE	8
OBJECTIVES	18
NARRATIVE	20
EQUIPMENT and SAMPLING REPORTS	28
INITIAL RESULTS	119
REFERENCES	138
STATION LIST	140
MAPS	143

SCIENTIFIC PERSONNEL

name	surname	institute	Role
Veerle	Huvenne	NOC	PSO
Daniel	Jones	NOC	Biologist/watch leader
James	Strong	NOC	Habitat mapper/watch leader
Catherine	Wardell	NOC	Geophysical processing
Tabitha	Pearman	NOC	Biologist
Ana	Jesus	JNCC	DEFRA/JNCC rep
Chris	Pearce	NOC	Geochemist
Declan	Morrissey	MI	Biologist/Irish observer
Noelie	Benoist	NOC	Biologist
America	Zelada	USoton	Habitat mapper
Brett	Hosking	NOC	Image analist
Maaten	Furlong	NMF-MARS	Principle Scientist / Senior Technician
Dave	Turner	NMF-MARS	ISIS
Andy	Webb	NMF-MARS	ISIS
Russell	Locke	NMF-MARS	ISIS
Stephen	McDonagh	NMF-MARS	ISIS
Josue	Viera-Rivero	NMF-MARS	ISIS
Rachel	Marlow	NMF-MARS	Autosub / C-Worker
Phil	Bagley	NMF-MARS	Autosub / C-Worker
Richard	Austin Berry	NMF-MARS	Autosub / C-Worker
Dale	Carter	NMF-MARS	Autosub / C-Worker
Owain	Shepherd	NMF-MARS	Autosub / C-Worker
Steve	Woodward	NMF-MARS	Gliders
Mike	Smart	NMF-MARS	Gliders
Richard	Morrison	NMF-MARS	ALR / Drone
Naomi	Gold	NMF-MARS	Drone / Autosub
Terry	Wood	NMF-MARS	Drone / C-Worker
Juan	Ward	NMF-SE	IT & Sea Systems

SHIPS OFFICERS AND CREW

John	Leask	Master
Andrew	Mahon	Chief Officer
Michael	Hood	2 nd Officer
Thomas	Williams	3 rd Officer
Chris	Uttley	Chief Engineer
Michael	Murray	2 nd Engineer
Gavin	Nicholson	3 rd Engineer
Gary	Slater	3 rd Engineer
Eric	Jenkins	ETO
Paul	Lucas	Purser
Martin	Harrison	Chief Petty Officer - Scientific
Nathan	Gregory	Chief Petty Officer - Deck
Steven	Duncan	Petty Officer - Deck
Brian	Conteh	Engine Room Petty Officer

Brian	James	Seaman Grade 1A
John	Allen	Seaman Grade 1A
Barry	Edwards	Seaman Grade 1A
Jarrold	Welton	Seaman Grade 1A
Amy	Whalen	Head Chef
Ross	Tucker	Chef
Jane	Bradbury	Steward
Kevin	Mason	Assistant Steward
Hamish	Reid	Cadet
Adrian	Gordon	Cadet
Christopher	Reid	Cadet

ITINERARY

Departure Southampton: 19 June 2018

Arrival Southampton: 6 July 2018

Cruise track chart:

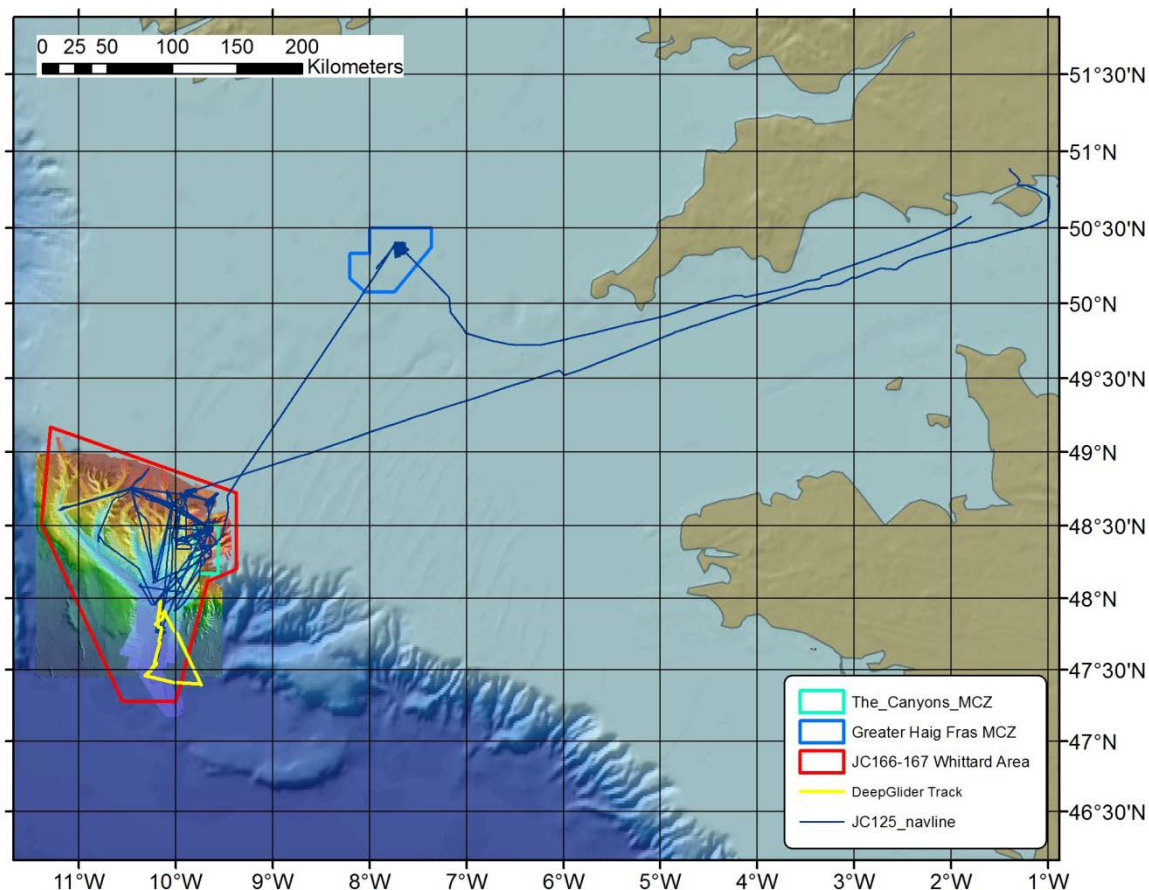

Fig. X.1 Cruise track plot

BACKGROUND AND SCIENTIFIC RATIONALE

CLASS programme, sustained observations and technological development

CLASS (Climate Linked Atlantic Sector Science) is the National Capability Single Sector Marine Research Programme funded by NERC for the period 2018-2023. It aims to deliver the knowledge and understanding of the Atlantic Ocean system that society needs to make evidence-based decisions regarding ocean management. CLASS will address key knowledge gaps in the understanding of ocean variability, climate regulation and ocean services, and will assess how the ocean will evolve as a result of climate change and intensified human exploitation.

CLASS is being delivered through the combination of an Atlantic focussed science programme, and a series of activities that underpin Marine Science within the UK: sustained ocean observations in the Atlantic, world class model development, and state of the art technology.

The objective behind the CLASS sustained ocean observations is to create and expand multi-decadal records of ocean parameters that provide insights in the temporal evolution of the Atlantic, from the surface to the seafloor, and from the coast to the deep sea. The programme includes a number of repeat transects across the Atlantic, a number of fixed-point water column observatories, and a number of repeat seafloor & habitat monitoring sites. The latter include sites from the shelf (Western Channel Observatory, Haig Fras Marine Conservation Zone), slope (Darwin Mounds Marine Protected Area, Whittard Canyon & Canyons Marine Conservation Zone) and abyssal plain (Porcupine Abyssal Plain), which will be surveyed on a regular basis (yearly for the WCO and PAP, every 3 years for Haig Fras, every 5 years for Whittard Canyon and every 8 years for the Darwin Mounds).

As part of the science programme within CLASS, the results of those repeat surveys will be used to create an improved understanding of the role and impact of abrupt seafloor disturbances on benthic communities, including their resilience and recovery; looking both at natural and anthropogenic disturbance events. The impact of human activities in the marine environment is extensive and increasing, as countries around the world develop their blue economies. Direct impacts, such as fishing, drilling, mining or the construction of seafloor installations, can have long-term effects on benthic communities, exceeding the natural levels of variability and disturbance those communities are adapted to. However, because direct impacts are often related to specific events or pressures, direct impacts are often manageable through marine spatial planning, such as the designation of fishery closures or establishment Marine Protected Areas. Correct information and knowledge about the long-term evolution and/or recovery of benthic systems following major disturbances hence is paramount to support effective marine spatial planning.

As part of its data collection strategy CLASS will utilise existing state of the art sensors and Marine Autonomous Systems. Furthermore it will leverage new development throughout the programme to improve data collection in terms of quality, cost and volume. To maximise the benefit of these new measurement tools it is critical that they are fully tested and that the scientists understand the advantages and disadvantages of the new systems. To enable this dual objective it is intended that trials and demonstrations are undertaken alongside the CLASS science programme. Examples of this approach are the JC166-7 expedition, and the DY108-9 combined science cruise and Oceanids BioCAM sensor trial.

To fulfil part of the CLASS objectives as described above, the expedition JC166-167 set sail for the Haig Fras MCZ and Whittard Canyon system.

Haig Fras MCZ & monitoring site (*Jesus, A. & Benoist, N.*)

The Greater Haig Fras Marine Conservation Zone (MCZ)¹ was designated in January 2016 under the Marine and Coastal Access Act 2009. It protects 2,041km² of continental shelf habitats surrounding a fully submarine granite outcrop (the Haig Fras Rock Complex) with depths ranging between 50m and 200m. The subtidal rocky

¹ For more information on the Greater Haig Fras MCZ visit the site information centre: <http://jncc.defra.gov.uk/page-7135>

complex within the site is a designated feature (Annex I reef) of the Haig Fras Special Area of Conservation (SAC) (see Fig X.1). It is the only rocky reef on the Celtic Shelf, west of Cornwall.

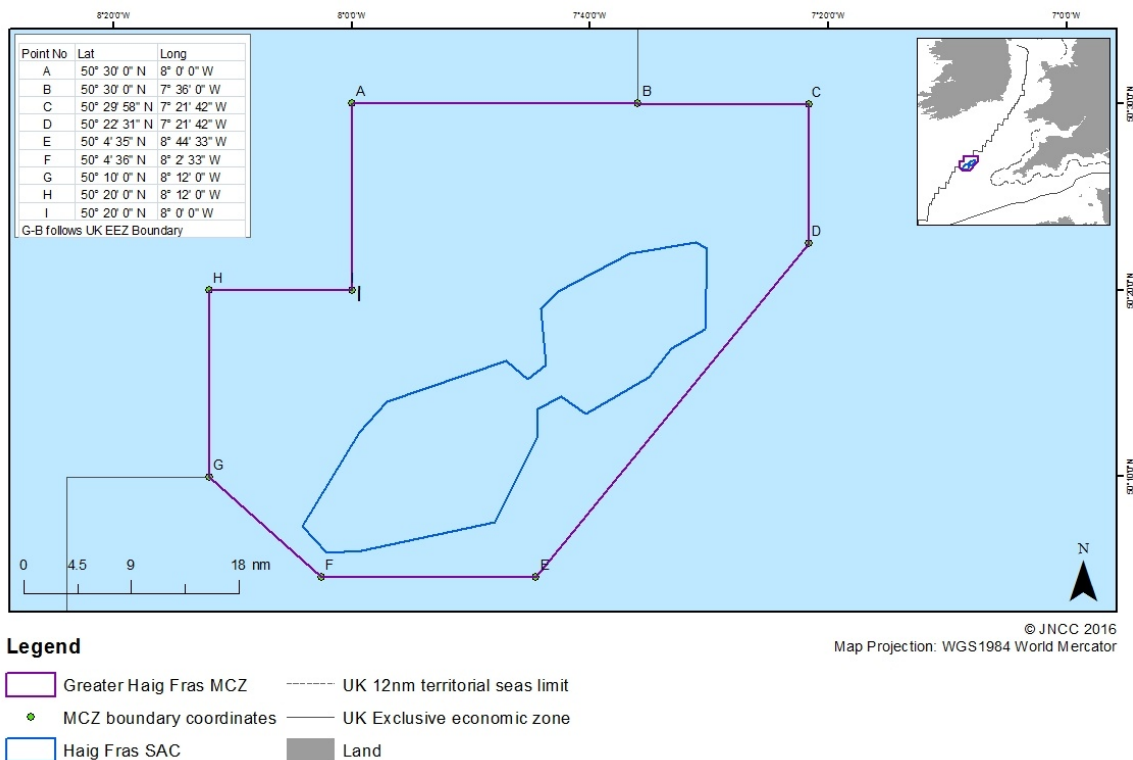

Fig. X.1. Site boundary for Greater Haig Fras MCZ

The MCZ has six designated features: Subtidal coarse sediment, Subtidal sand, Subtidal mud, Subtidal mixed sediments, the MCZ Feature of Conservation Importance (FOCI) Sea-pen and burrowing megafauna communities, and the Haig Fras rock complex geological feature (see Table X.1).

Table X.1 Designated features and General Management Approach for the Greater Haig Fras MCZ

Designated Features	Feature Type
A5.1: Subtidal coarse sediment	Broad-Scale Habitat
A5.2: Subtidal sand	Broad-Scale Habitat
A5.3: Subtidal mud	Broad-Scale Habitat
A5.4: Subtidal mixed sediments	Broad-Scale Habitat
Sea-pen and burrowing megafauna communities	Feature of Conservation Importance
Haig Fras rock complex	Geological Feature

The variety of subtidal sediments present at the MCZ supports a range of organisms including many species of polychaete worm and bivalve mollusc that live within the sediment, and epifaunal species such as sea urchins and starfish. Sea-pen and burrowing megafauna communities, an OSPAR Threatened and/or Declining habitat, are found in the deeper areas of the site.

A proposal for the regulation of fishing activity within the Greater Haig Fras MCZ is currently being progressed under the EU Common Fisheries Policy (CFP), as required when a marine protected area falls outside the UK's 12 nautical mile limit.

Repeat AUV survey in the Greater Haig Fras Marine Conservation Zone

Autosub6000 operations in the Greater Haig Fras Marine Conservation Zone (GHF-MCZ; Fig. X.2) were undertaken during JC166-167 as part of the Climate-linked Atlantic System Science project (CLASS). This year's mission was the third of a long-term monitoring project initiated in 2012 as part of the Defra (Department for Environment, Food, and Rural Affairs) funded project "Investigating the feasibility of utilizing AUV and Glider technology for mapping and monitoring of the UK MPA network (MB0118)" (D377-M59; 25-26 July 2012; Wynn et al. 2012; Ruhl 2013). Similar operations were repeated in 2015 as part of the Defra-funded project "Novel AUV and Glider deployments to inform future MPA and MSFD monitoring strategy in UK shelf waters" (JC124-M86/87; 10/12 August 2015, Huvenne et al. 2016).

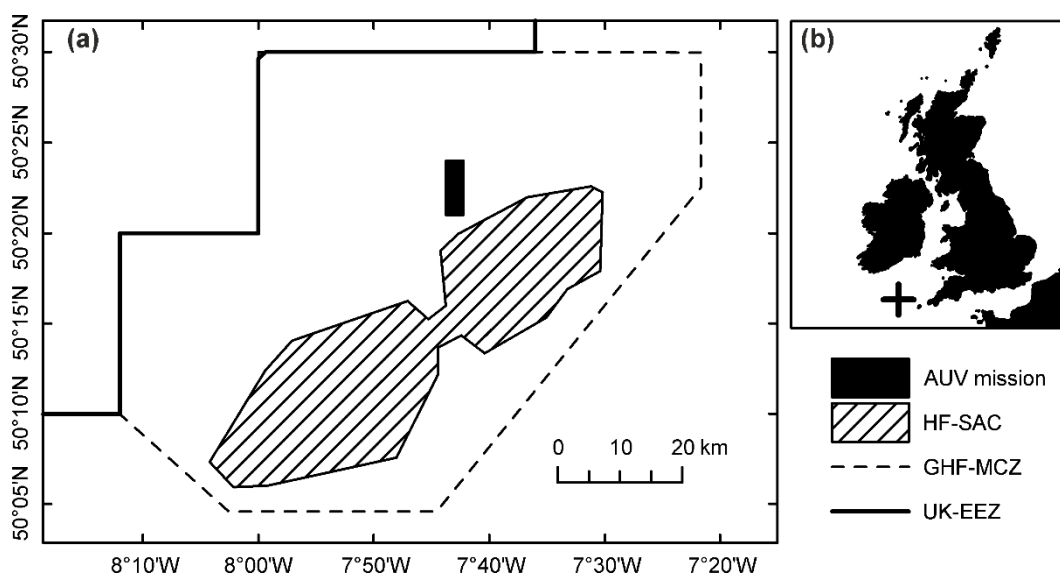

Fig. X.2 Survey location. (a) Greater Haig Fras marine conservation zone (GHF-MCZ). (b) Area of AUV survey and adjacent Haig Fras special area of conservation (HF-SAC). (Map source: Benoist et al. revised submission May 2018)

Both 2012 and 2015 photographic AUV surveys were processed in the OBE Deepseas subgroup at NOC to improve quality (non-uniform illumination and colour correction), rectified to a common seabed scale (2012, 0.59 mm pixel⁻¹; 2015, 0.50 mm pixel⁻¹), georeferenced, and mosaicked into groups of five consecutive images (tiles, each c. 7.3 m² seabed). The acoustic data (bathymetry, sidescan sonar) were processed at the Marine Geoscience group at NOC. Analysis of the 2012 baseline acoustic and photographic (n = 3,637 tiles; 19,223 m²) datasets demonstrated the capability of seabed AUV monitoring to efficiently assess benthic communities in relation to habitat type (sedimentary, mixed, hard substrata) in an MCZ (Benoist et al. revised submission May 2018). This work also permitted to assess the influence of sampling unit choice on the quality of those photographic data, concluding that standardising to a minimum number of individuals, rather than a fixed seafloor area, can reduce the variance of community descriptors across habitats. Analysis of the 2015 repeat photographic dataset (n = 708 tiles; 5,142 m²) aimed at quantifying change in community composition three years later. This work also allowed assessing bias in manual photographic analysis between annotators, and showed that standardising sampling effort on the basis of optimal observable size (i.e. minimum size at which individuals can be consistently observed and identified; >10 mm in the present case) and level of taxonomic identification were necessary steps to compare photographic datasets fairly (publication currently in

progress). Initial results of the comparison between the 2012 and 2015 data indicate that the overall pattern of species composition is the same, but small differences may occur, particularly in the mobile fauna. The 2012 and 2015 (photo) surveys were carried out at different times during the day, which may or may not have had an influence.

The 2012 and 2015 sidescan sonar surveys are also being investigated for the development of automated seafloor classification techniques, in order to support habitat mapping and monitoring. Investigations so far have shown that Random Forest is the most robust automated seafloor classification algorithm, providing an accuracy of 63.7% (Zelada, 2018). Classification of sidescan sonar datasets collected over the same area on consecutive days in 2015 indicated that the method provides 60.3% repeatability (under the assumption no measurable change had happened to the seafloor composition & pattern within 24 hours). Further repeat surveys are necessary to refine the algorithms and processing pipeline, and to establish the source of the differences between maps of consecutive days.

Whittard Canyon and The Canyons MCZ (Pearman, T. & Jesus, A.)

Submarine canyons incise the continental margin and act as the main pathways between the shelf and the deep-sea (Fernandez-Arcaya et al., 2017; Huvenne and Davies, 2014; Amaro et al., 2016). Their presence on the margin leads to modified local shelf circulation and sedimentation (Fernandez-Arcaya et al., 2017). At the same time, irregular topography within the canyon can induce and modify hydrodynamics resulting in internal tide and bore generation (Hall et al., 2017).

Canyon geomorphology and substrata vary from vertical bedrock to muddy plains supporting a variety of habitats. This high environmental heterogeneity can lead to enhanced productivity, biodiversity, and faunal abundance (De Leo et al., 2014; De Leo et al., 2010; Vetter et al., 2010; Robert et al., 2015). Because of this, canyons have been advocated as 'key stone' features (Vetter et al. 2010).

Submarine canyons are under increasing anthropogenic pressures, including from offshore exploration, fishing, pollution and climate change (Fernandez-Arcaya et al., 2017; Pierdomenico et al., 2016). To enable effective spatial management of these features, accurate habitat maps and an understanding of canyon processes (i.e. oceanography, sediment dynamics, and community ecology) are required.

Whittard canyon is a large dendritic canyon system that incises the south-west corner of the UK continental shelf at ~200 m water depth (Fig. X.3). The canyon is comprised of four main branches that coalesce at approximately 3600 m depth, from which an outflow channel forms that leads to the depositional fan and further onto the Porcupine Abyssal Plain (Amaro et al., 2016).

Increased diversity has been observed within the canyon (Gunton et al., 2015), which supports a variety of habitats, including vertical wall communities of *Acesta* bivalves and cold-water coral (CWC) (Johnson et al., 2013; Huvenne et al., 2011; Robert et al., 2015). The CWC reefs represent features of conservation interest (Davies et al., 2017; OSPAR, 2008; 92/43/EEC, 1992).

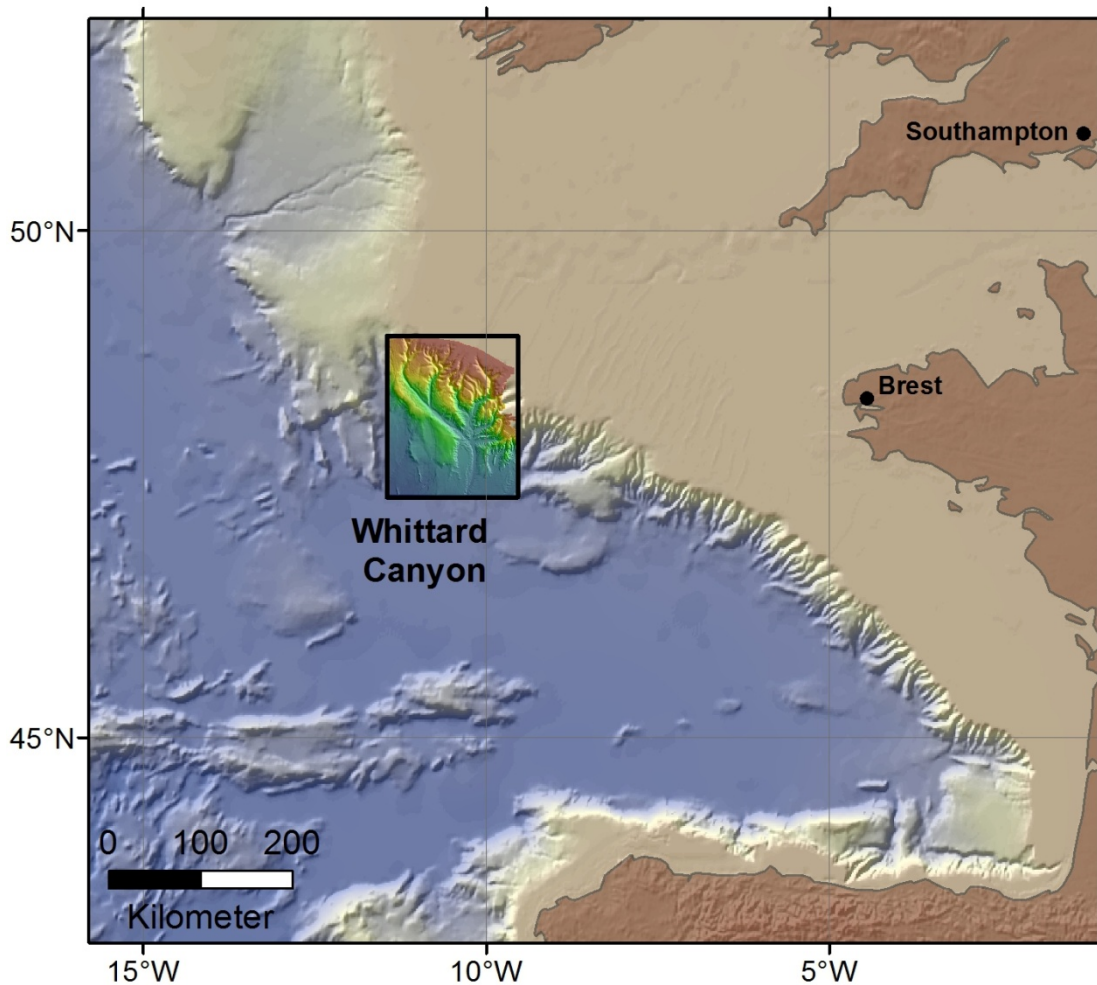

Fig. X.3 Location Map Whittard Canyon. Whittard Canyon bathymetry provided by the Geological Survey of Ireland, INFOMAR programme. Background bathymetry by GEBCO (2003)

The Canyons MCZ

The Whittard Canyon system includes the Dangaard and Explorer Canyons, which are included within The Canyons MCZ², the only deep-sea MCZ in English waters (see Fig. X.4).

² For more information on The Canyons MCZ visit the site information centre: <http://jncc.defra.gov.uk/page-6556>

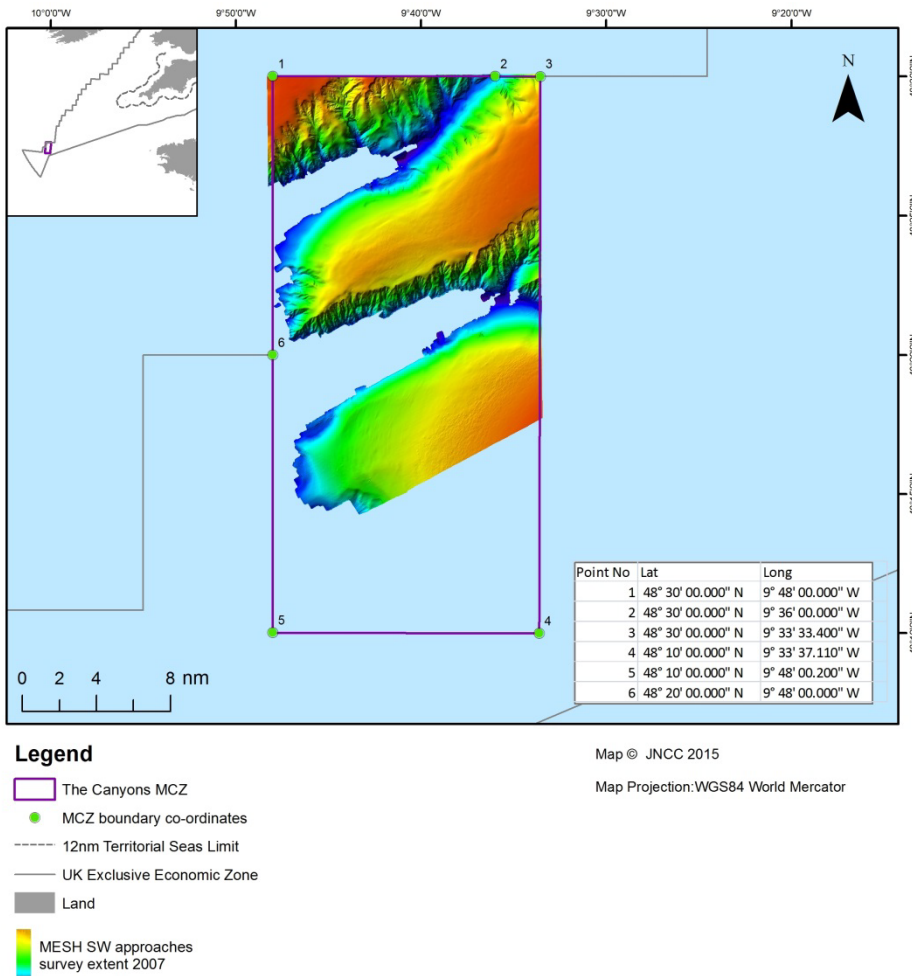

Fig. X.4. Site boundary for The Canyons MCZ

The Canyons MCZ was designated in November 2013 under the Marine and Coastal Access Act 2009, to protect cold-water coral reefs, an MCZ Feature of Conservation Importance (FOCI), and the broad-scale habitat Deep-sea bed (Table X.2). It covers an area of 661 km², with depth ranging between 100 m and 2000 m.

Table X.2 Designated features and General Management Approach for The Canyons MCZ

Designated Features	Feature Type
A.6: Deep-sea bed	Broad-scale habitat
Cold-water coral reefs	Feature of Conservation Importance

Live *Lophelia pertusa* reefs, an OSPAR Threatened and/or Declining Habitat, were found on the northernmost wall of the Explorer Canyon (Davies et al., 2014). Reefs formed by the cold-water coral *Lophelia pertusa* provide a three-dimensional structure and a variety of microhabitats that provide shelter and an attachment surface for other species. Cold-water corals are long-lived but can be extremely slow growing, making protection important for their conservation. *Madrepora oculata*, another reef-forming cold-water coral, is also present within the MCZ.

The Deep-sea bed present within The Canyons MCZ contains a variety of substrata, including bedrock, biogenic reef, coral rubble, coarse sediment, mud and sand. These can support cold-water coral communities (*Lophelia pertusa* and *Madrepora oculata*) and a range of assemblages characterised by feather stars (*Leptometra*

celtica), burrowing anemones, squat lobster (*Munida sp.*), barnacles and deep-sea sea-pens (*Kophobelemnon sp.*).

Mini-mound features 3 m high and 50-150 m in length occur on the interfluves between the Dangaard and Explorer canyons. The mounds comprising variations of shell, coarse sediment and coral rubble support communities dominated by ophuroids and munida (Davies et al., 2016). The mounds were mapped by AUV high-resolution sidescan sonar during JC125, which demonstrated a high density of trawl marks in the area (Fig. X.5). Fine resolution assessment of the status of the mini-mounds, and whether they support unique species assemblages (including whether they support CWC and/or have the ability to support them and why) can assist management of these features and further our understanding of the processes that influence species assemblage and CWC distributions in the MCZ.

A proposal for the regulation of fishing activity within The Canyons MCZ is currently being progressed under the EU Common Fisheries Policy (CFP), as required when a marine protected area falls outside the UK's 12 nautical mile limit.

Predictive habitat mapping

Identifying and mapping features of conservation interest is recognised by several international organizations as a key activity in ensuring their protection (e.g.: UN vulnerable marine ecosystems, OSPAR Threatened and/or Declining species/ habitats and EU Habitats Directive Annex I habitats). However, this can be challenging in the deep sea where surveys are constrained by cost and technological capabilities. Predictive mapping offers a powerful tool to assist in the production of maps and is based on extrapolating known species- environment relationships (Elith and Leawick 2009, Guisan and Zimmermann 2000).

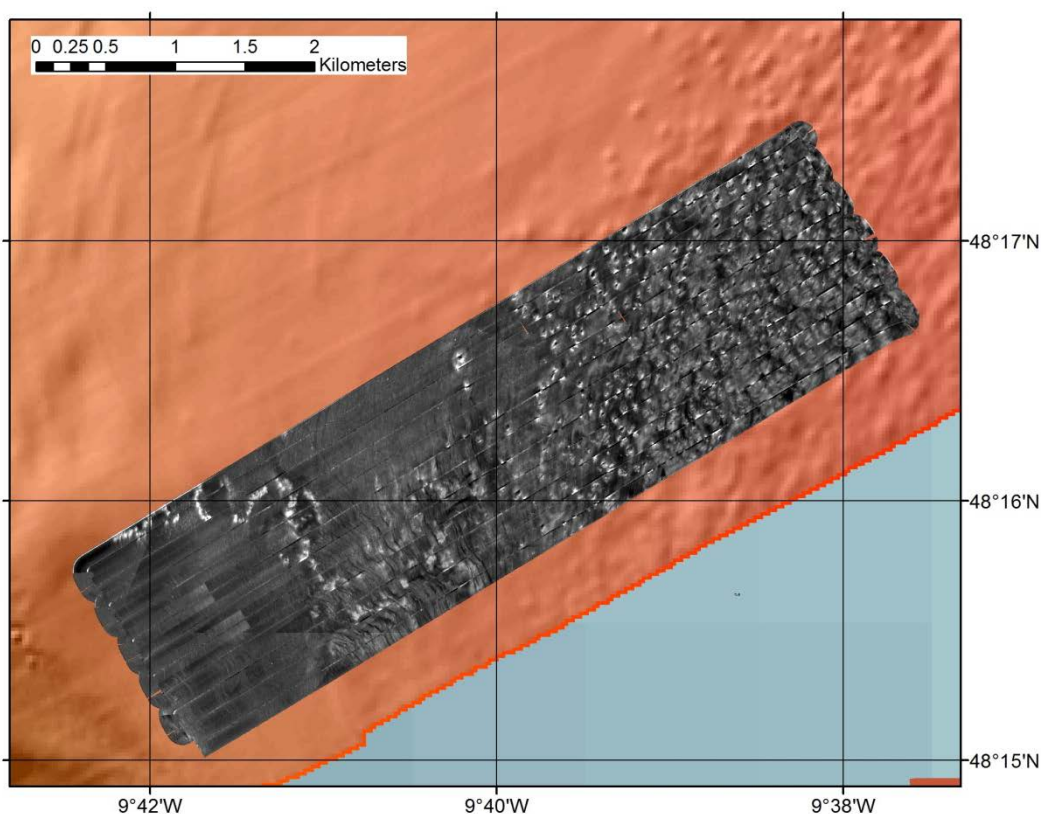

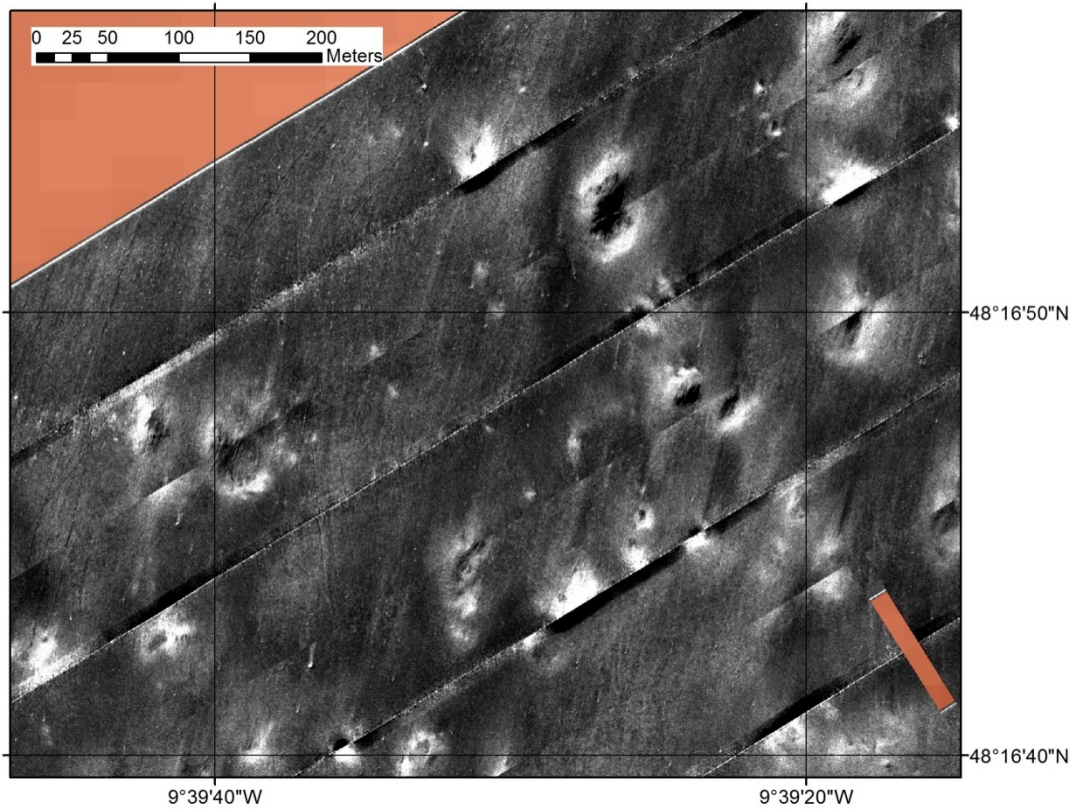

Fig. X.5 Autosub 6000 sidescan sonar map of minimounds area (top), with zoomed-in section (bottom) illustrating the high density of trawl marks in the area. Data collected during JC125.

Maps based on the predictive distribution of diversity and CWCs have been developed from data acquired during the JC010, JC036 (Robert et al., 2015) and JC125 cruises. The ability to further ground-truth predictive models with independent data sets and acquire additional training data in under-sampled regions of the canyon is an important component of model development and assessment (Elith and Leathwick 2009, Guisan and Zimmermann 2000). Additional sampling will ensure increasingly robust predictive models and maps.

OBJECTIVES

1. Cruise aims:

The overall aims of the cruise were four-fold:

- Re-survey of the Haig Fras site (for the CLASS project)
- Training of ROV and AUV engineers
- Equipment trials
- Acquisition of opportunistic data from Whittard Canyon

This translated into the following planned activities:

Science:

Planned activities at Haig Fras – Main science objectives

- ✓ AUV MBES, sidescan sonar and photography survey as repeat of the surveys in 2012 and 2015
- ✓ Second AUV survey, repeating the sidescan sonar and photography aspect once more, at different time of day

Further suggested activities at Haig Fras:

- AUV photography (either separate survey or extending one of the already planned surveys) over muddy grounds (*Nephrops* habitat), as this is one habitat type in the area that is not covered by the current survey layout.
- ✓ During AUV surveys: making use of ROV to carry out video surveys for JNCC.
- ✓ Sampling of voucher specimens with the ROV to aid taxonomic identification from AUV photography
- ROV-based MBES (forward-looking?) or photogrammetry of rocky vertical substrates to help investigate the influence of substratum aspect on species distribution and morphology.

Suggested activities around Whittard Canyon:

- ✓ ROV video surveys (plus collection of voucher specimens and pushcores) as suggested by JNCC (ground-truthing in the Canyons MCZ)
- ✓ ROV video surveys (plus collection of voucher specimens and pushcores) at other locations within Whittard Canyon to ground-truth species prediction models
- ✓ ROV video survey or AUV photo survey over small (<5m height, 75-100m across) mini-mounds on the canyon interflaves at site surveyed by Autosub6000 in 2015
- ✓ Further AUV survey (sidescan sonar, chirp, photography) on different interflave to compare minimounds and trawling impact
- ROV photogrammetry survey over the cold-water coral reef in the Explorer branch of Whittard Canyon (same site as visited in 2015, ~800m depth) to investigate changes in reef morphology & structure. Placing recognisable markers (e.g. bricks) will help with scaling and future re-visits.
- AUV MBES and sidescan sonar survey of a sandwave field at the head of the eastern branch of Whittard Canyon (same location as 2015) to monitor sandwave migration and to create bathymetry map
- ✓ Collection of ROV pushcores in lower canyon/Whittard Channel (~4200m) for study of microplastics
- Collection of ROV pushcores at 3900m depth at site of macrofauna study conducted in 2009
- Potentially picking up settling experiments for Louise Allcock (NUI Galway) and Maria Baker
- Sampling of cold-water corals for genetics and paleoceanography (*Desmophyllum* for Laura Robinson, U Bristol; and *Lophelia* & *Solenosmilia* for in-house studies in collaboration with Michelle Taylor, U Essex)

Engineering:

Autosub6000 objectives

- ✓ Train the new AUV staff to operate the Autosub6000 vehicle in preparation for DY094 (FAPESP)
- ✓ Field test the EdgeTech and Camera code to add meta-data to the raw data files.
- ✓ Trial the use of SonarWiz for analysing the EdgeTech 2200 sidescan & sub-bottom profiler, and Kongsberg EM2040 multi-beam data
- ✓ Review synchronisation of documentation taken to sea with the shore side data store

Isis ROV objectives

- ✓ Train new staff (both ROV and AUV team) in using the Isis ROV and HyBIS RUV
- ✓ Test live streaming of the Isis ROV video feed to shore as a proof of concept.

Deepglider and Waveglider objectives

- ✓ Trial the newly acquire Deepglider in deep water as part of its commissioning into the NMEP.
- ✓ Trial the launch and recovery of the Liquid Robotics SV3 waveglider from our research vessels, and evaluate the performance of the Sonardyne acoustic modem installed in the waveglider.

C-Worker Unmanned Surface Vehicle Testing

- ✓ Trial the launch and recovery of the C-Worker 4 USV from the RRS James Cook.
- ✓ Test the setup of the control of the vehicle from the ship and assess the range that the C-Worker 4 could be effectively operated to.
- Test the performance of the Sonardyne USBL beacon installed on the C-Worker 4

ALR1500 long range echo-sounder

- ✓ Trial the ALR1500 long range echo-sounder in a variety of different water depths and terrain types to assess its performance prior to operation on the ALR1500 vehicle.

General MARS objectives

- ✓ Produce training material (videos and photographs) of the operations of MARS equipment
- ✓ Test the use of a Quadcopter from the ship, and assess its utility in providing training material and operational support to the other teams.

NARRATIVE

Monday 18 June 2018 (JD169)

Mobilisation for JC166 was temporarily halted to accommodate a VIP visit of the UKRI directorate to the ship. Sir Mark Walport and his colleagues came on board at 11:45BST, visited the Autosub & ISIS on the main deck, the ROV control room and some of the labs. Lunch was served at 12:15BST, after which the delegation visited the bridge. They left the ship by 13:15BST, after which mobilisation resumed.

The science party joined the ship between 2 and 3pm, and met for a first short science meeting at 15:00BST. All was set and ready to go by the evening.

Tuesday 19 June 2018 (JD170)

The science team and new technicians attended the compulsory safety briefing at 09:30BST. The RRS James Cook set sail from Empress Dock, Southampton, at 11:20BST. The weather was warm, slightly overcast, with a good breeze. As we were sailing out of Southampton Water, the EM710 system was tested and the optimal settings were tried out.

A safety drill and boat muster took place at 16:15BST, and the science & technical team held a meeting to go through the cruise objectives at 18:30BST. The transit continued safely throughout the night.

Wednesday 20 June 2018 (JD 171)

Clocks changed to GMT overnight. Good progress was made on the transit to the first study area (Haig Fras) during the night, and continued until late afternoon. The weather was fair, sea state ~3.

We arrived at the first waypoint just north of the Haig Fras AUV survey area at 16:50z. As HyBIS was rigged up, attached to the deep-tow cable, it was used as a frame to attach the sound velocity probe and record a sound velocity profile (JC166-001-SVP01). We also attached one of the USBL beacons to the frame to allow for a test, which was successful. The frame was deployed at 17:09z and was back on board at 17:19z.

This operation was followed by tests and training on the deployment of Autosub6000. The AUV was successfully lowered into the water, and recovered again (but stayed attached to its lines). However, the contact with the water caused a groundfault which needed further analysis before the system could be deployed again.

At the same time, the sound velocity profile was uploaded into the multibeam acquisition software SIS, and at 20:15z we went on transit to WP004 to start the EM710 calibration ("patch test"; JC166-002-MBES01). The patch test data acquisition was started at 21:10z, and finished at 22:34z. While the system offsets were calculated, the ship travelled to WP011, in order to start the actual EM710 multibeam survey at 23:04z (JC166-003-MBES02). We decided to operate the EM710 system with the dropkeel down, to make sure we achieved the optimal quality data, avoiding bubbles under the hull as much as possible. We kept this set-up for the coming days.

Thursday 21 June 2018 (JD 172)

The multibeam survey ran smoothly overnight, although the weather had picked up to a sea state 4. We continued the survey until 09:44z, at the end of a line, when the ship was stopped in order to allow repairs to the Autosub to take place safely on the aft deck. The upper syntactic foam had to be lifted off in order to enable access to the batteries.

While the Autosub engineers were repairing the system, the Deep Glider was shortly put in the water for a buoyancy test, which was successful. The attempt to communicate with the system through a Benthos acoustic transducer, however, was not successful.

Later on in the afternoon, the Autosub Long Range and glider teams also tested their Phantom 4 quadcopter (drone), which produced some wonderful footage of the ship and the AUV tests.

The Autosub work continued until 16:30z, after which the science team started another short EM710 multibeam survey at 16:44z, which ran till 17:57z (JC166-004-MBES03). We then moved to the first HyBIS site, one of the priority areas where JNCC had suggested video surveys. The transit and ship setup took till 18:52z, after which HyBIS was swiftly deployed for its first tow (JC166-005-HY028). The system was basically used as a towed platform, as there were issues with the thrusters that needed further diagnostics. However, although the tow was short, it was very successful, with clear images of the benthic habitat and species. HyBIS was back on board at 19:50z, and the ship set off to resume the EM710 multibeam work. The survey started at 20:42z (JC166-006-MBES04).

Friday 22 June 2018 (JD 173)

Multibeam surveying went smoothly overnight, and continued until 07:36z when we transferred to the next HyBIS site. The weather was very good, sea state 1-2, with light winds. We arrived at 07:55z, and following some preparations by the HyBIS team and some issues with the winch, the vehicle was in the water by 08:58z (JC166-007-HY029). Again a very good video tow followed. HyBIS was brought on deck by 11:38z.

The next operation was to test Autosub in the water again, but to do this, an acoustic beacon needed to be integrated in the vehicle, and that beacon was fixed to HyBIS. Once the beacon was transferred, Autosub was tested in the water. No immediate groundfault occurred, but the system did not communicate – either via WIFI or via the acoustic transponder. Having the vehicle in the water however did provide another good training opportunity for the new winch drivers.

Once back on board, the team started the diagnostics to identify the faults in the communication. In the meantime, the science team picked up the EM710 multibeam survey where they left it off (JC166-008-MBES05) 13:30z, with the idea to move to the Autosub first test mission later on in the afternoon. Unfortunately, once the fault with the WIFI was identified, a new problem arose, this time with the Autosub data logger. This required significantly more work to repair, hence the multibeam survey continued. At the same time the HyBIS team started work again on identifying the issues with the HyBIS thrusters. This continued until 20:00z but no conclusive cause could be found.

By 21:00z it became clear that Autosub would also not be ready in the morning, and would need another day of repairs and tests. The decision was then made to transit to deep water (Whittard Canyon), to allow the rest of the technical and potential scientific cruise programme to be carried out. The EM710 survey was broken off at 21:32z, and a new 'transit' station was started (JC166-009-MBES06).

Saturday 23 June 2018 (JD 174)

The transit continued smoothly overnight, at a maximum speed of 10kn through the water to protect the EM710 dropkeel which was still deployed. The multibeam system continued providing very good data until 10:42z, when the water depth increased rapidly as we started to cross Explorer Canyon. The weather was still very good, sea state 1-2, sunny and with very light winds.

When the water depths became too much for the EM710 system (~650m, at 10:42z), we started up the EM122 multibeam system and continued the transit (JC166-010-MBES07).

When arrived at the deep-water site, the first activity was the deployment of the deep glider (JC166-011-DGL01). The system was deployed at 15:21z, and started diving at 15:47z. The ship was then repositioned 2 nm north in order to stream the ROV wire to ca. 4000m water depth. A USBL beacon and the SVP were attached to the weight, hence this operation is considered as a science station (JC166-012-SVP02). The deployment started at 16:28z and was finished at 20:47z.

With the weight and instruments back on board, we started the multibeam work for the night. The first task was to carry out a patch test for the EM122 system (JC166-013-MBES 08). It took a little time for the bridge to be set up for the exercise, but at 23:02z the data recording started, and the work was finished at 02:11z the next morning.

Sunday 24 June 2018 (JD 175)

Calm weather, sea state 1-2. Following the patch test, the actual MBES surveying could start at 02:54z (JC166-014-MBES09). It continued till 08:00, when we arrived back at the deep water location for another ROV wire streaming exercise. The weight was in the water by ~08:20z, and back on deck by 12:40z. As there were no scientific instruments attached to the system, this was not recorded as a station.

The next operation consisted of the calibration of a new echosounder to be mounted on Autosub Long Range (ALR). The instrument was lowered on the deeptow wire to a depth of 1500m, in a series of stages, to collect small amounts of data at 20, 50, 100, 200, 500, 1000 and 1500m depth. It was lowered over the side at ~13:07z and back on deck at 15:28z (JC166-015-ECH01). Unfortunately the system had not recorded any data. We still decided to move to the next station, at 3000m depth, while an investigation was carried out, to ensure that by 8pm we would be at the optimal location for our overnight multibeam survey. We recorded multibeam data on the transit (JC166-016-MBES10), starting at 15:53z and finishing at 17:13z. At 17:20z, the ALR echosounder was deployed again (JC166-017-ECH02), this time only to a depth of 20m, but it still did not record any data. It was back on deck at 17:27z, and we resumed the multibeam work at 17:43z (JC166-018-MBES11). At the end of the survey line, at 19:42z, we started a transit to a sandwave area at the head of the eastern branch of Whittard Canyon (JC166-019-MBES12). As the seabed shallowed, we switched from the EM122 to the EM710 multibeam system by 21:22. We arrived at the sandwave area at 22:26z, to carry out the dedicated survey at 8kn (JC166-20-MBES13).

Monday 25 June (JD 176)

Still calm weather. The sandwave multibeam survey was continued till 04:46z, when we went back on transit south to the study area in the Canyons MCZ. At 07:54z we arrived at the starting waypoint for the first ROV dive of the cruise, but the first operation was to shortly deploy the AUV. Over the last two days, the engineers had worked hard to rebuild the data logger and the communication links, and a new test was in order. This provided encouraging results, and allowed the team to continue preparations towards an actual deployment.

Next on the schedule was an Isis dive over the minimounds in the Canyons MCZ, but during the pre-dive checks a fault with the power supply was detected. This was rectified, and a few hours later ISIS was ready for deployment (JC166-021-ISIS340). She was off the deck by 13:10z, and performed a very good dive, coming back on board at 19:35z with 6 pushcores and a variety of biological samples.

While ISIS was in the water, the ALR echosounder was tested once more at 10m waterdepth, with a short deployment from 14:01z till 14:15z (JC166-022-ECH03). Unfortunately the fault persisted and the engineering team decided to re-build the instrument using spare components, to be ready for deployment the next morning.

Following the successful ISIS dive, we went back to multibeam bathymetry (JC166-023-MBES14), going back to the sandwave area we had started mapping the night before. We set off at 19:57z, and started the sandwave survey at 22:34z.

Tuesday 26 June 2018 (JD 177)

Still calm weather, sea state 1-2. The multibeam work continued till 07:42z, including the transit back south to the Canyons MCZ. Next on the schedule was a real test mission for Autosub, and following the necessary pre-dive checks on deck, the system was deployed and released in the water at 11:26z (JC166-024-M142). The sub started the dive at 11:34z, and carried out all required paths and trajectories. It came back at the surface by 17:02z, and was back on deck by 17:52z. The system had performed well throughout most of the mission, although at ca. 15:13z the data logger fell over, and no further navigation or attitude data were recorded. Also the photocamera stopped working at that point, which meant that although a lot of pictures were taken in the water column, by the time the vehicle was working close to the seabed, no pictures were recorded. The EdgeTech sidescan sonar system did perform very well though, and both low frequency and high frequency data were recorded.

The Autosub team spent the rest of the day analysing the fault in the data logger, in order to have an optimal vehicle for potential deployment the next day. Although by 20:00z the fault was not fully identified, it was decided to go back to the Haig Fras research area in the hope that we would be able to fulfil the cruise objective of collecting the repeat survey data the next day.

Multibeam data collection started again at 20:25z (JC166-025-MBES15).

Wednesday 27 June 2018 (JD178)

Calm weather, but winds increased and sea state increased a bit as well. We arrived at Haig Fras at 10:47z, and set up the ship to deploy the waveglider (JC166-026-WGLDR01). This operation went very smooth, and by 11:00z the system was in the water. It performed its pre-set path without problems, however a test to create a connection with a USBL beacon lowered on the ALR echosounder (JC166-027-ECH04; 13:27z – 14:32z) was less successful. In the shallow waters the ship could not come close enough to the waveglider for the beacon to come into the cone of its USBL system. To recover the waveglider, the rescue boat was deployed at 15:35z, and the waveglider was brought alongside it by 15:40z. Although the weather conditions were very good, it was still challenging to bring the glider back to the ship with the rescue boat. Once alongside the vessel by 15:55z, the system was quickly hooked onto a line and lifted on board (16:00z).

With the waveglider safely on board, we moved to the AUV launch position for the Haig Fras repeat survey. It was decided to prioritise the photo and sidescan sonar parts of the re-survey, and to carry out both of them twice, in order to compare benthic communities during the day and the night, and to allow assessment of

automated habitat mapping techniques. The AUV was deployed (JC166-028-M143) at 17:10z, and started the dive at 17:26z. It recorded a very short photo transect, to check if the photologger worked well, which was confirmed to be the case when it surfaced at 18:30z. It was then sent off on its actual mission.

Given the previous difficulties with the datalogger, it was decided to 'babysit' Autosub for this deployment. Initially the plan was to follow the AUV, so that good USBL navigation could be obtained. However, again as a result of the shallow location, the vehicle soon disappeared out of the cone of the USBL system. When we tried to follow it with the ship, the vibrations on the AUV 'fish' (acoustic communication system deployed over the port quarter) were deemed to be too intense, so instead the ship took a position in the middle of the AUV mission and registered the vehicle going past on each of its survey lines.

At 23:07z the vehicle had finished its first sidescan sonar run, and came to the surface for a rendez-vous. All systems were still working well, hence it was ordered to continue the mission at 23:21z.

Thursday 28 June 2018 (JD 179)

The next rendez-vous took place at 03:50z. Unfortunately this time the datalogger had failed, and a few hours later also the photologger gave up. The system was rebooted and sent off again at 04:17z to complete the second sidescan sonar run. This was finished at 09:24z, and appeared successful. Still, to be sure that no errors had built up, the system was rebooted again before it dived for a last time at 10:13z for the final photo run. The vehicle came to the surface at 14:41z, was sighted at 15:07z and was on deck by 15:22z.

While Autosub was completing its mission, we also collected a new sound velocity profile for the area (JC166-029-SVP03), as the profile that we collected the week before did not provide good results at the surface any more. The SVP was in the water at 12:47z and back on deck at 13:00z.

With the AUV on board, we moved to the start point of the next ROV dive – one of the pairs of video transects requested by JNCC. We arrived on site at 16:25z, and the ROV was deployed at 16:54z (JC166-030-ISIS341). To give the ROV team extra training, the vehicle was deployed, then lifted back on board, and then deployed again. It reached the bottom in no time (water depth of ~75m), and a good dive followed, exploring the rocky and sandy substrata of the Haig Fras reef. The system was back on board at 21:29z.

To respect the hours of rest of the technicians, we spent the night collecting multibeam data (the science team being on watches since the start of the cruise). The survey started at 22:23z (JC166-031-MBES16).

Friday 29 June 2018 (JD 180)

Another beautiful, flat calm day followed. The multibeam work continued until 08:38z (including transit to ROV waypoint), at which point the vessel set up for the deployment of the C-worker 4 ASV (JC166-032-ASV01). The vehicle was lifted into the water at 10:42z, and drove off nearly immediately. It performed very well and was easy to manoeuvre, but lost UHF connection as soon as the vehicle was more than 4.5km away from the ship. Following further testing, the system was driven next to the ship, and after a few attempts it was hooked up and lifted on board at 13:14z.

The ASV recovery operation had brought us quite far from the ROV Dive start point, hence we needed some time to transit back. By ~14:15z we were on station and set up for the dive (JC166-033-ISIS342). Isis went into the water at 14:45z and once more completed a successful dive at one of the JNCC requested survey sites. The ROV was back on deck at 19:24z.

Our final operation at Haig Fras was another Autosub mission (JC166-034-M144), partly to repeat the night-time photography, and to add a multibeam survey to the dataset. We travelled to the deployment point just north of the study site, and arrived there ~21:00z. After the deployment of the acoustic transponder ('fish'), Autosub was deployed at 21:24z, and started its dive at 21:35z.

Saturday 30 June 2018 (JD 181)

We had a rendez-vous with Autosub at 01:46z, and everything seemed in good shape, so the system was sent off on the multibeam part of the survey at 02:06z. It surfaced again at 09:38z, and was lifted on deck by 10:22z.

With this activity we finished our work at Haig Fras, so we set steam for Whittard Canyon once more. Multibeam data were collected along the transit (JC166-035-MBES17).

Sunday 1 July 2018 (JD 182)

We reached the Whittard Canyon at 0017z, and started the dedicated EM122 multibeam survey (JC166-036-MBES18) at 01:17z. The survey was planned to fill in a gap in the coverage from previous years. By 07:42z, however, the ship had to start the transit to WP045 to set up for a new ALR echosounder test (JC166-037-ECH05). We arrived on site at 08:18z, and by 08:43z the test package was in the water. The system was lowered to 50, 200, 500, 1000 and 1500m and then brought back on deck by 11:02z.

The next operation on the plan was an ROV dive, but the weather had significantly deteriorated overnight, with wind speeds up to 22-25kn, a confused swell and wave heights up to 2-3m. With those conditions, it was decided to call off the ROV dive, and to carry out another ALR echosounder test. We moved to a point at 3000m water depth, and deployed the package at 13:04z (JC166-038-ECH06). It was brought back on board by 15:13z.

At this point, the weather was still too marginal for safe ROV and AUV work, so we resorted once again to multibeam surveying (JC166-039-MBES19). The first section, between 15:43z and 19:45z consisted of further EM122 work to fill in a few gaps that were left from the overnight work. After that, we moved to an interfluvium north of the Canyons MCZ that has not yet been mapped by multibeam and started a survey there at 20:28z (JC166-040-MBES20).

Monday 2 July 2018 (JD 183)

The EM710 work was finished by 06:36z, and the ship went on transit to the start location of the next ROV dive. Along that line, the multibeam system was swapped to the EM122 between 06:38z and 07:57z (JC166-041-MBES21). However, at approx. 07:20z, the officers on the bridge realised they had mis-typed the location of the waypoint, and a sharp course correction was necessary. The last part of the transit, from 07:59z till 08:28z was recorded with the EM710 multibeam (JC166-042-MBES22).

Although the swell was still considerable, the winds and wave heights had come down significantly over night, and the conditions were deemed workable for an ROV deployment. We set up on site at 08:28z, and following the last pre-dive checks, the ROV was in the water at 09:42z. Dive 343 (JC166-043-ISIS343) lasted till 15:46z, and was once again a success.

A long transit to deep water followed (JC166-044-MBES23), during which Belgium beat Japan in a nailbiting game of the World Cup. We arrived on site at 21:06z, and prepared for the AUV launch. During the pre-mission

checks, it became clear that there were problems with the AUV forward-looking sonar (collision avoidance sonar – an oil leak was detected). Given that we were working in a submarine canyon, even if at the lower canyon where the terrain is less steep, it was considered that this instrument would be essential for any mission here, and hence the mission was cancelled.

With no other equipment to deploy (or staff who weren't out of hours to deploy said equipment), we resorted once more to multibeam surveying (JC166-045-MBES24). The ship was underway at 22:22z, and continued the EM122 work until the next morning, when we had a rendez-vous with the deep glider (to finish station JC166-011-DGLDR01).

Tuesday 3 July 2018 (JD184)

The EM122 survey around the Whittard Channel finished at 05:30z, when the deep glider was spotted and the ship set up for deployment. Recovery went exceptionally smooth, and at 05:42z the instrument was on board. Weather conditions by now were very good, sea state 1-2, very light winds.

Next on the schedule was the deployment of the wave glider (JC166-046-WGLDR02), for which we had to move position a little. The ship came on site at ~06:40z, and the glider was deployed at 06:53z. The plan was now to run a communication test between the wave glider and an acoustic beacon that would be lowered through the water column, strapped to the ROV (JC166-047-ISIS344). However, as preparations for the ROV launch were carried out, it became clear that one of the cameras on the ROV was only rated to 4000m, while the maximum depth of the dive was 4180m. Hence the dive location was moved to slightly shallower water, and the waveglider made its way to that area independently.

ISIS was in the water by 10:01z, and reached the requested 500m depth by 10:42z. There it had to wait for a while as the waveglider was catching up with the ship's position. Once it was in place, the ROV continued its step-wise dive, and reached the seabed at 15:14z. Bottom-time was just under 2 hours, and by the end of the dive the fibre in the fibre-optic cable that carried the HD video signal had a fault, so no further HD video data came up to the control van. This was not a safe way of operating, hence it meant the end of the dive. As ISIS came up to the surface, at ca. 120m depth, the video signal came back, but a ground fault on the starboard thruster incurred. The ROV was safely recovered and came on deck at 19:24z.

Following the safe recovery of ISIS, the ship was re-positioned to 4200m water depth, where another test with the ALR echosounder took place (JC166-048-ECH07). We also attached the sound velocity probe to the system. The package was deployed at 20:36z and came back on deck at 22:48z.

In the meantime the waveglider had slowly but steadily been making its way north, and the plan was to pick it up early the next morning. To cover the spare time in between, more multibeam data were collected (JC166-049-MBES25). The survey started at 23:30z.

Wednesday 4 July 2018 (JD 185)

Multibeam surveying was halted at 05:07z, to allow for the pick-up of the wave glider (JC166-046-WGLDR02). The rescue boat met up with the glider at 05:25z, and by 05:47z the whole package was on deck. We resumed the multibeam work at 06:09z, which was by mistake added to station JC166-049-MBES25.

We arrived at the next ROV site at 10:28z, and the ship set up for the deployment. However, with the technical issues that occurred the evening before, the ROV team needed a little more time to prepare the vehicle for the next dive. It was decided to pin the umbilical in the swivel head, to avoid further strain on the fibre-optic

wire at that point. The fault on the thruster was repaired, but a new problem with the left arm (Kraft) came up, that meant the arm could not be used for the next dive (hence no use of the suction sampler). Still, by 12:27z, the vehicle was in the water (JC166-050-ISIS345), and a smooth dive in Explorer Canyon followed, during which we discovered a new patch of cold-water coral reef. By 16:55z the ROV was back on deck, and once all was secured, we set off on our long transit home. We decided to record opportunistic multibeam data on the transit, even if no accurate sound velocity profile would be obtained along the way.

Thursday 5 July 2018 (JD 185)

Further transit – stop in Falmouth Bay for ~4-5hours

Friday 6 July 2018 (JD186)

Continued transit, arrival in Southampton Empress dock at 18:00z. Belgium won the world cup quarter finals against Brazil. ;-)

EQUIPMENT & SAMPLING REPORTS

1. Autosub6000 Cruise Report

Operational Team : Rachel Marlow, Owain Shepherd, Dale Carter, Richard Austin-Berry, Phil Bagley, Maaten Furlong (ST)

1.1. Objectives

- AUV team training. Rachel Marlow and Maaten Furlong are experienced Autosub operators. However, the rest of the team are new to the group and the main objective was to train the new staff in AUV operations at sea.
- Haig Fras Survey. To provide the third AUV survey (previous surveys in 2012, and 1015) at Haig Fras as part of the on-going monitoring of this area

1.2. AUV sensor configuration

The AUV configuration is shown with all relevant dimensions in the drawings below.

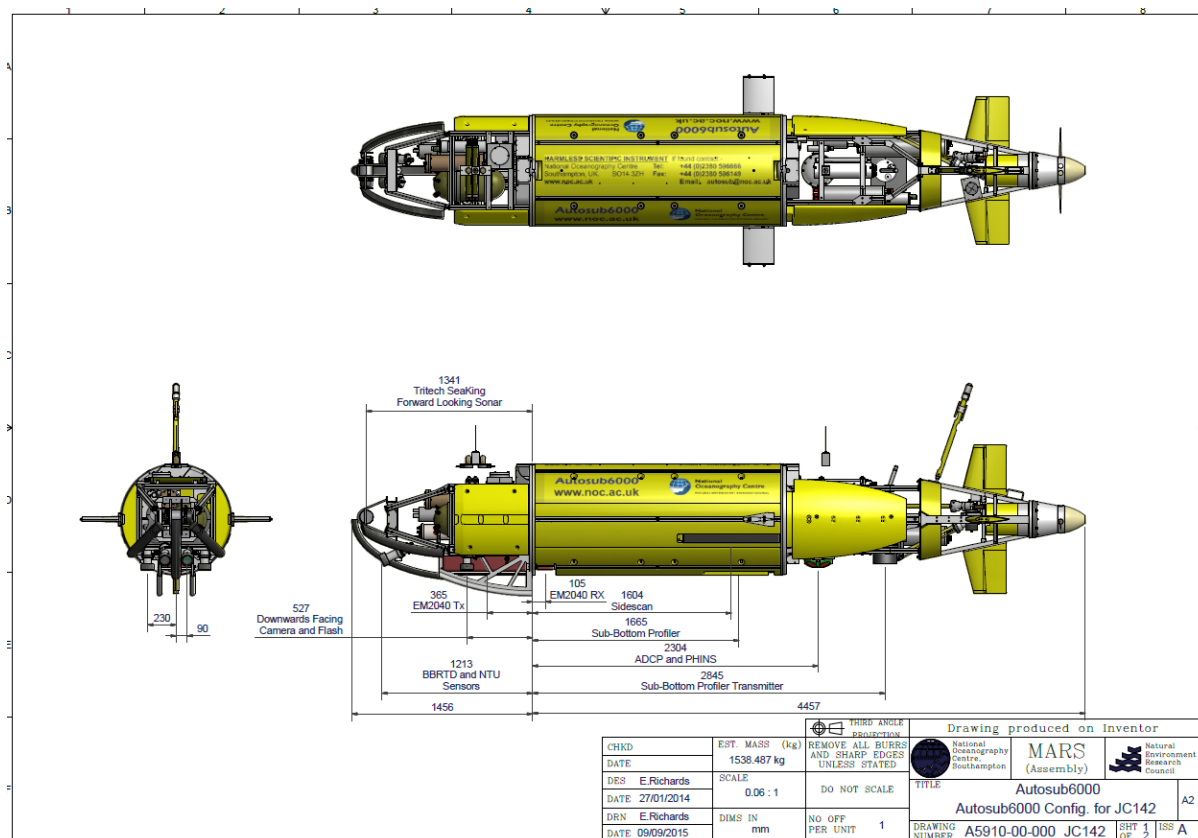

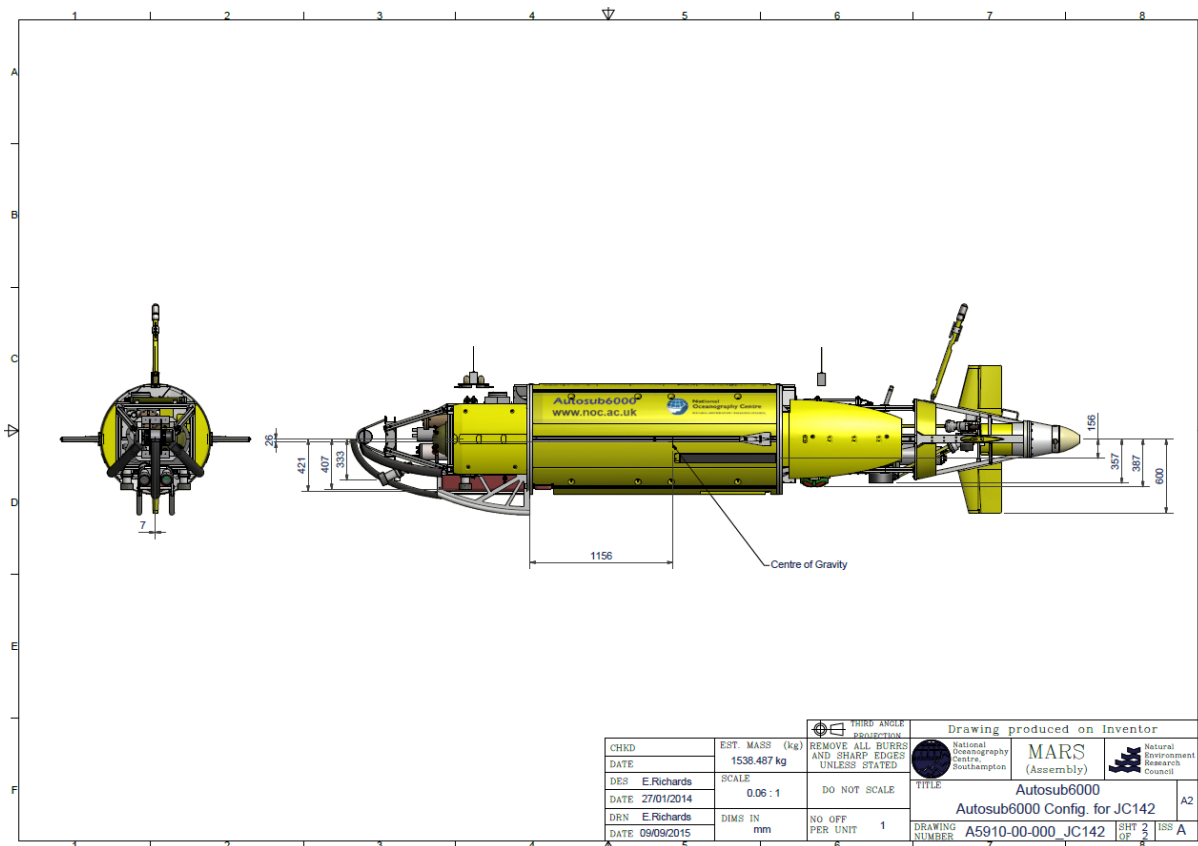

1.3. Launch & Recovery Training Sessions

Prior to the Autosub6000 missions a number of training sessions were carried out to train Owain Shepherd and Richard Autsin-Berry on the operation of the Autosub6000 Launch and recovery system (20-22 June 2018). The Autosub was hard wired into the LARS and lowered over the stern with the ship moving ahead at approximately 0.5 knots. After allowing the Autosub to float in the sea for a short period of time, the vehicle was then recovered.

1.4. Mission Summaries

During the cruise three missions were attempted with a four aborted due to a number minor faults arising just prior to deployment coupled to time constraints on the cruise. The missions undertaken are outlined in the table below.

Mission	Area	Date	Distance Covered	Notes
142	Whittard Canyon	26/6/2018	15 km	Short trials mission for the AUV. Completed mission, but main logger and camera logger stopped mid mission
143	Haig Fras	27/7/2018	90 km	2 x HF Sidescan surveys completed 1 x Camera survey completed 1 x failed camera survey
144	Haig Fras	29/7/2018	51 km	1 x Multibeam survey 1 x Camera survey (repeat of the failed survey in M143)
145				Aborted due to minor faults coupled to cruise time constraints

1.5. Fault Report

A number of Autosub6000 faults occurred outside of the missions described in the summary reports. These occurred during Launch and recovery training and during vehicle preparation for the missions. For completeness all Autosub faults during the LC166/7 cruise (during missions, and outside missions) are listed here.

The faults arising particularly around the data loggers (main logger and camera logger) had a considerable impact on the limited success of the cruise. Although the key CLASS science objectives were met, the opportunistic targets were not achieved, and the AUV had to be nursed through its missions to confirm the logging was operational.

Fault	Date	Description
1	20/06/2018	Motor ground fault occurred during LARS training. The fault persisted when the vehicle was brought back on deck. Fault isolated to the red battery harness. Removed top central syntactic foam section and found some minor connector water ingress on battery pack S11
2	21/06/2018	Motor ground fault occurred after LARS training. During LARS training the motor ground fault remained low, however on recovery of the vehicle a knock to the rear end of the top central syntactic foam section generated a motor ground fault. Removed the gutter protecting the battery harness, and replaced the central syntactic foam section.
3	22/06/2018	WiFi connection to the Autosub was lost Prior to the fault we had sporadic WiFi contact with the Autosub. Investigations suggested the fault resided with the WiFi module in the Logger tube. WiFi module replaced, and container wifi antenna replaced with a more powerful bullet antenna. WiFi communications restored.
4	22/06/2018	Not able to communicate with the logger tube With WiFi communications restored, it was not possible to remote desktop into the logger tube. However, it was possible to connect to all other Autosub subsystems. The logger tube was removed and a logger hard disk crash was diagnosed. The hard disk was replaced with the Autosub 3 hard disk, and a period of software updating was required before full logger operation was restored.
5	25/06/2018	Motor and hotel ground fault The motor ground fault had been observed when the vehicle was out of the water. A ground fault is detected between the power tube case and 0V. Therefore, it should only be possible to detect a ground fault when the vehicle is submerged in seawater. Reviewing the circuit suggested that ac noise would pass through filter capacitors and trigger a ground fault circuit. Tests using an oscilloscope between battery 0V and the power tube housing confirmed high levels of ac noise (up to 6V P-P). Therefore, it was concluded the in air Motor ground fault was not real and could be ignored for the remainder of the cruise. Note that the ground fault reset once the Autosub was in the water so we could still detect a motor ground fault during a mission.

		The hotel ground fault was resolved by re greasing all connectors in the hotel circuit
6	26/06/2018	Main logger stopped functioning (M142) The logger application appeared to still be running although it was unresponsive. Looking at the data directory showed that it was no longer writing log files.
7	26/06/2018	Camera logger stopped recording images. (M142) The camera control application appeared to be running and images being captured to memory but not being written to disk. The logging of camera images appeared to stop at a similar time to the main logger stopping logging.
8	26/06/2018	Edgetech navigation data appeared to stop (M142) Edgetech navigation data appeared to stop when the sensor was changed from low frequency to high frequency or possibly when the main logger stopped, exactly when needs investigating.
9	27/06/2018	Main logger and camera logger failed after first section of mission (M143) The logger seemed to hang and stop recording data shortly after diving and the camera logger application closed or the PC rebooted after two hours into the next mission section. Main logger was restarted after this mission section and all appeared to be normal.
10	29/06/2018	Camera logger appeared to reboot on the descent to do the camera survey (M144). Once rebooted though it kept going through out the camera survey.
11	2/07/2018	Mission code would not load (M145 abandoned) In preparation for mission 145 the mission script would not download to the Autosub. It kept failing at mission line 59. A typo in the mission script (using 00 rather than 0) was diagnosed.
12	2/07/2018	Argos transmission failed to be repeated in the main lab (M145 abandoned) During pre -launch checks no Argos detections were seen on the lab repeater. Using the spare Gonio and spare antenna Argos transmissions from both the Autosub beacons were confirmed. Monkey island Gonio was replaced connected to the original antenna. Sporadic Argos receptions were observed. Later analysis showed that one of the two antenna leads connecting nto the Gonio was shorted.
13	2/07/2018	CTD 5T submersible pump (Serial no. 05-6791) noisy CTD pump noisy, cleaned out with warm water and will be investigated back at base.

1.6. Mission Summary Sheets

Detailed summaries of the missions undertaken are described in the following summary sheets.

M142 Mission Summary

Campaign	JC166/7	Mission Number	M142
Operating Area	Whittard Caynon	Science Station No.	
Vehicle Configuration			
Sensors used		Sub configuration	
<ul style="list-style-type: none"> • RDI workhorse ADCP 300kHz downwards. • PHINS INS • Seabird 9+ CTD with dual CT sensors • EM2040 multi-beam • EdgeTech 2200-M 120-425kHz side scan and 2-16kHz sub-bottom profiler • 1 x colour downwards camera and flash • 1 x colour forward camera and flash • Tritech Seaking obstacle avoidance sonar • Sonardyne G6 USBL Transponder 		<ul style="list-style-type: none"> • Rear winglets set at 6° pitched downwards. • Autosub 6k recovery line retention system with nylon springer lines • 14.2kg positive buoyancy. • 4 complete battery packs (6 battery modules), and 1 further battery pack loaded with 5 battery modules. • Autosub6000 Lawson launch and recovery system (LARS) 	
Mission Objectives			
Mission to test buoyancy, deceleration, Edgetech and cameras			
Mission Conditions			
	Start of Mission	End of Mission	
Time (Logger)	26-Jun-2018 08:07:22	26-Jun-2018 15:22:20	
Position (GPS)	N48:25.928 W9:37.911	N48:25.022 W9:38.365	
Sea state	Calm	Calm	
Wind speed	F2	F2	
Battery Voltage (V)	45.15 [V]	43.35 [V]	
Mission Statistics			
Total Mission Duration	7hrs 14mins	Time on Seabed	
Avg. Decent Speed		Avg. Ascent Speed	
Mean Ground Speed at Bottom	0.57 m/s	Distance Travelled	14.7 km
Mean Motor Power	209.9 W	Maximum Depth	291.0 m
Mission Description			
<p>1. Control Systems Test Box Dive: A NESW box with 5 minute sides at depth 50m, depth 100m, altitude 150m and altitude 150m. Timed runs to ensure timely surfacing. Surface for data assessment and GO/NOGO test.</p> <p>2. Power and deceleration runs to test the performance of the new motor and to get a drag estimate: The AUV will then surface to down load the data and test the performance</p>			

3. Sidescan Test. LF and HF side scan survey to test SonarWiz

4. Camera Survey. Brief Camera survey to test the Grasshopper 2 camera, and the altitude step up for the cable at Haig Fras

Mission Waypoints

Waypoint	Position
WP1	N:48:25.9360, W:9:37.8660
WP2	N:48:25.1840, W:9:38.2860
WP3	N:48:24.6950, W:9:38.5480

Mission Map

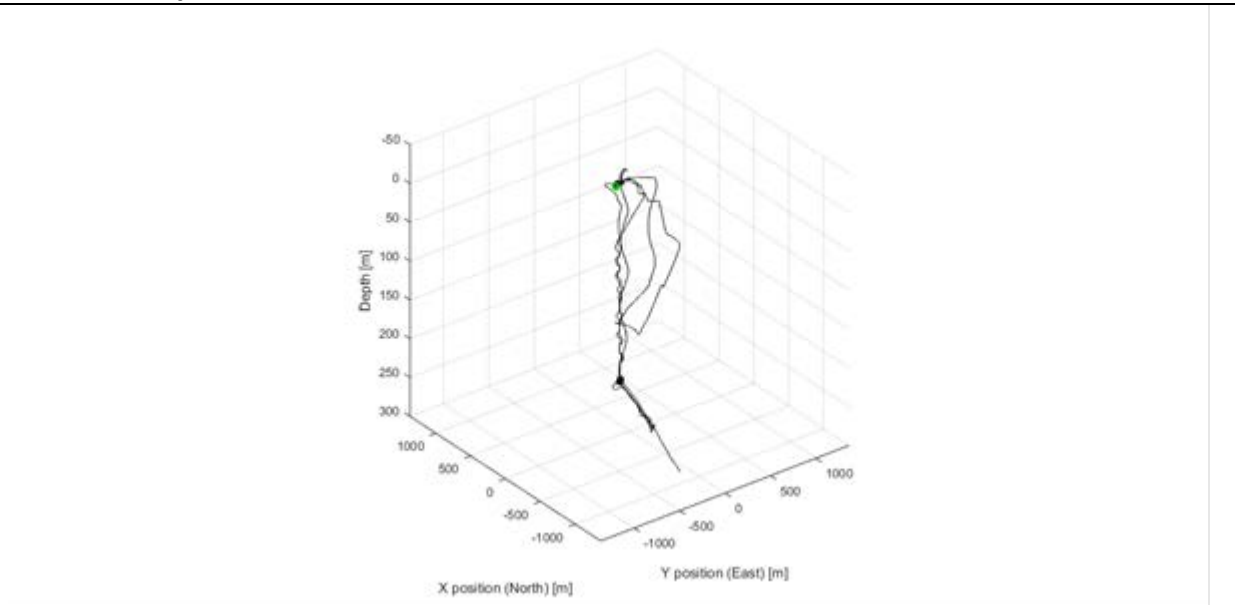

Mission Review

The AUV was launched and recovered successfully and monitored via the ships USBL and the Linkquest throughout the mission. The AUV first dived and performed a short NESW box at differing depths before returning to the surface where the engineering data were analysed. All data seemed good so the AUV was sent to perform the power and deceleration runs to test the performance of the re-wound motor. The AUV then returned to the surface and the engineering data inspected. All data looked good and the AUV was commanded to dive and perform the side scan and camera surveys. The tracks were completed successfully although on surfacing it became clear that the main logger had stopped functioning and the camera logger had stopped logging images. However, it appeared the cameras were still working and able to capture images. The Edgetech recorded throughout the survey as it did not receive the message to stop (due to logger malfunctioning)

Initial Assessment of Sensor Data Quality

Sensor	Assessment
EM2040 – N/A	N/A
CTD, DO	OK, until the main logger crashed
Seaking Sonar	Not reviewed

Magnetometer	Not reviewed
ADCP	Not reviewed
Side scan Sonar (425kHz)	OK, navigation data missing after logger crash. As USBL data of mission is available it might be possible to post process to locate the Side scan data.
Side scan Sonar (120kHz)	OK
Sub-Bottom Profiler	Not reviewed
AESA Cameras	Although working altitude too high to record seabed images (as planned)

Faults

Fault 1 – Main logger stopped functioning. The logger application appeared to still be running although it was unresponsive. Looking at the data directory showed that it was no longer writing log files.

Fault 2 – Camera logger stopped recording images. The camera control application appeared to be running and images being captured to memory but not being written to disk. The logging of camera images appeared to stop at a similar time to the main logger stopping logging.

Fault 3 – Edgetech navigation data appeared to stop when the sensor was changed from low frequency to high frequency or possibly when the main logger stopped, exactly when needs investigating.

Vehicle Performance Data

Battery Voltage

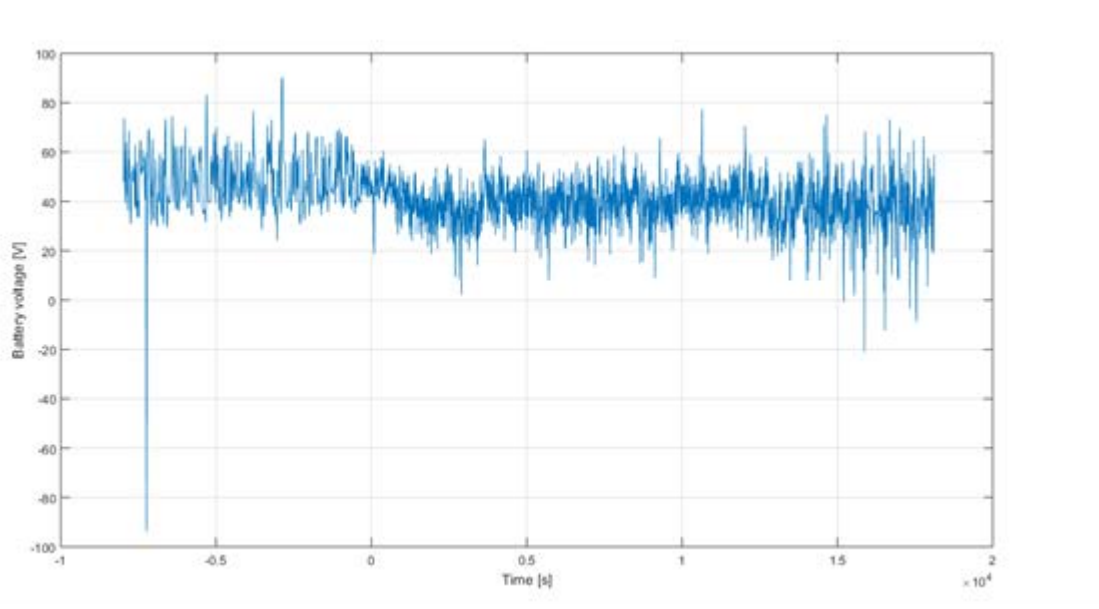

Speed through water and Propeller Speed

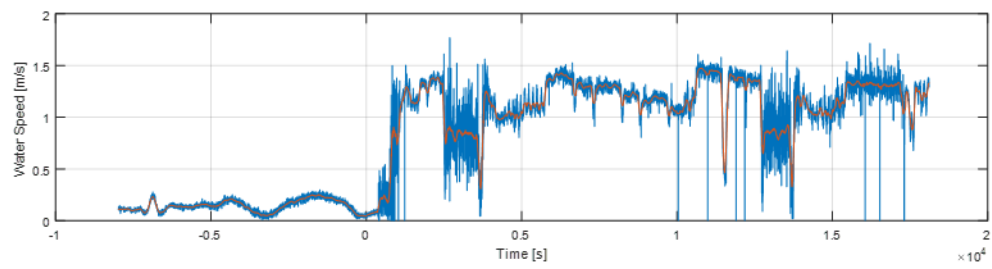
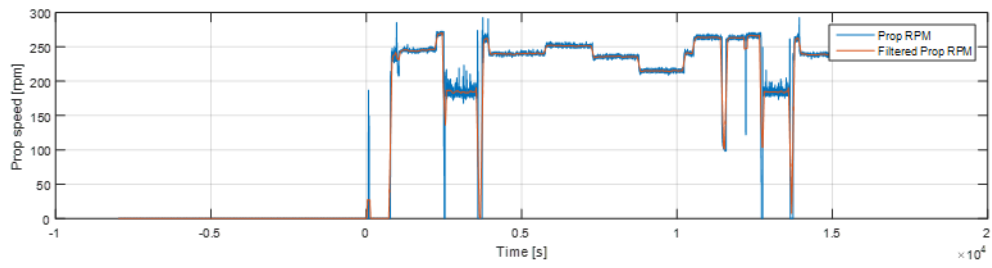

Altitude

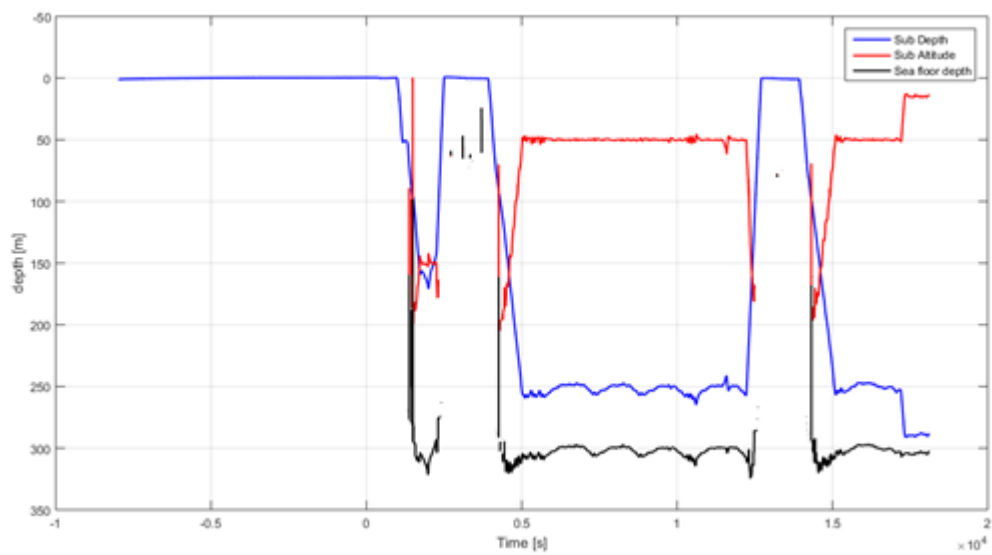

M143 Mission Summary

Campaign	JC166/7	Mission Number	M143
Operating Area	Haig Fras	Science Station No.	
Vehicle Configuration			
Sensors used		Sub configuration	
<ul style="list-style-type: none"> • RDI workhorse ADCP 300kHz downwards. • PHINS INS • Seabird 9+ CTD with dual CT sensors • EM2040 multi-beam • EdgeTech 2200-M 120-425kHz side scan and 2-16kHz sub-bottom profiler • 1 x colour downwards camera and flash • 1 x colour forward camera and flash • Trittech Seaking obstacle avoidance sonar • Sonardyne G6 USBL Transponder 		<ul style="list-style-type: none"> • Rear winglets set at 6° pitched downwards. • Autosub 6k recovery line retention system with nylon springer lines • 14.2kg positive buoyancy. • 4 complete battery packs (6 battery modules), and 1 further battery pack loaded with 5 battery modules. • Autosub6000 Lawson launch and recovery system (LARS) 	
Mission Objectives			
HF Side scan and camera surveys of Haig Fras with surfacing between each mission section to monitor the health of the main logger and camera logger.			
Mission Conditions			
	Start of Mission	End of Mission	
Time (Logger)	27-Jun-2018 16:48:15	28-Jun-2018 15:05:08	
Position (GPS)	N50:23.997 W7:43.029	N50:23.853 W7:42.637	
Sea state	Calm	Calm	
Wind speed	F3	F3	
Battery Voltage (V)	51.83 V	43.50 V	
Mission Statistics			
Total Mission Duration	22hrs 16mins	Time on Seabed	-
Avg. Decent Speed	-	Avg. Ascent Speed	-
Mean Ground Speed at Bottom	1.06 m/s	Distance Travelled	90 km (approx..)
Mean Motor Power	292 W	Maximum Depth	108 m
Mission Description			
<p>1 - short 10m camera run followed by a surface inspection of images</p> <p>2 - HF side scan survey 15m altitude, - 4 hours</p> <p>3 - Surface and data inspection to make sure the logger is working</p>			

- 4 - Camera survey 3m altitude - 4 hours
- 5 - Surface and data inspection to make sure the logger is working
- 6 - HF side scan survey 15m altitude - 4 hours
- 7 - Surface and data inspection to make sure the logger is working
- 8 - Camera survey 3m altitude - 4 hours
- 9 - Surface, end mission and recover

1.7. Mission Waypoints

//PHOTO MISSION

WPB1 = N:50:23.717, W:7:42.722

WPB1b = N:50:22.325, W:7:42.726 //Cable exclusion zone starts

WPB1c = N:50:21.977, W:7:42.727 //Cable exclusion zone ends

WPB2 = N:50:21.275, W:7:42.722

WPB3 = N:50:21.275, W:7:42.943

WPB3b = N:50:21.933, W:7:42.947 //Cable exclusion zone starts

WPB3c = N:50:22.270, W:7:42.948 //Cable exclusion zone ends

WPB4 = N:50:23.717, W:7:42.943

WPB5 = N:50:23.717, W:7:43.179

WPB5b = N:50:22.224, W:7:43.178 //Cable exclusion zone starts

WPB5c = N:50:21.889, W:7:43.177 //Cable exclusion zone ends

WPB6 = N:50:21.275, W:7:43.179

WPB7 = N:50:21.275, W:7:43.247

WPB7b = N:50:21.876, W:7:43.245 //Cable exclusion zone starts

WPB7c = N:50:22.211, W:7:43.245 //Cable exclusion zone ends

WPB8 = N:50:22.281, W:7:43.247

WPB9 = N:50:22.639, W:7:42.789

WPB10 = N:50:23.716, W:7:42.789

//SIDESCAN MISSION

WPC1 = N:50:23.818, W:7:42.756

WPC2 = N:50:21.275, W:7:42.756

WPC3 = N:50:21.275, W:7:42.909

WPC4 = N:50:23.818, W:7:42.909

WPC5 = N:50:23.818, W:7:43.061

WPC6 = N:50:21.275, W:7:43.061

WPC7 = N:50:21.275, W:7:43.213

WPC8 = N:50:23.818, W:7:43.213

Mission Map

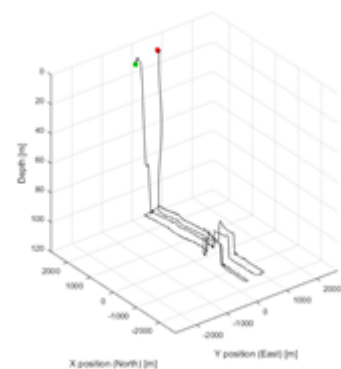
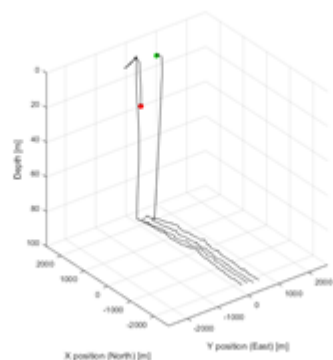
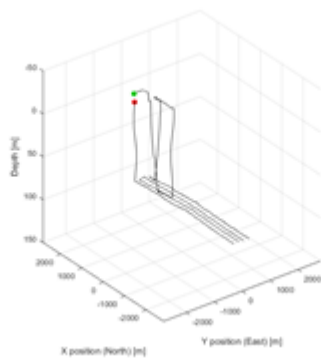

Mission Review

The AUV was deployed and recovered successfully. The first section of the mission was performed without issue and inspection of the loggers showed all to be normal. During the second section of the mission, the first camera survey, the main logger appeared to hang almost immediately after the AUV dived and the camera logger appeared to stop 2 hours later. The next section of the mission,

second side scan survey appeared to complete successfully. Before sending the AUV on the remaining camera survey the main logger was restarted and the camera logger was changed to start on booting of the camera logger, both actions were to try to limit the possibility of failure of the camera survey. On recovery the camera survey appeared to have completed successfully.

Initial Assessment of Sensor Data Quality

Sensor	Assessment
EM2040 – N/A	N/A
CTD, DO	OK, although some difference in sensors
Seaking Sonar	Not reviewed
Magnetometer	Not reviewed
ADCP	OK
Side scan Sonar (425kHz)	Good
Side scan Sonar (120kHz)	N/A
Sub-Bottom Profiler	Good
AESA Cameras	Failed on first camera section, good on second camera section

Faults

Fault 1 – Main logger and camera logger failed after first section of mission. The logger seemed to hang and stop recording data shortly after diving and the camera logger application closed or the PC rebooted after two hours into the next mission section. Main logger was restarted after this mission section and all appeared to be normal.

Vehicle Performance Data

Altitude Tracking

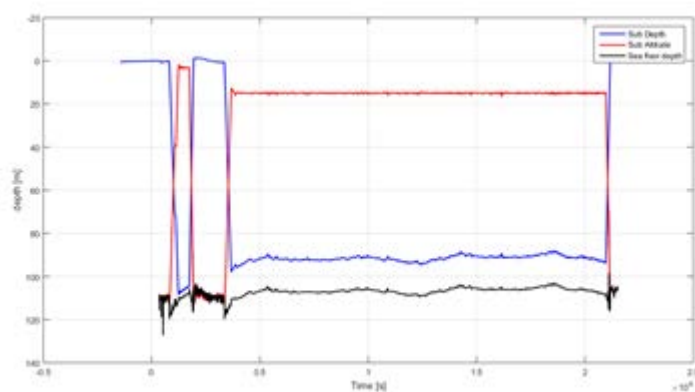

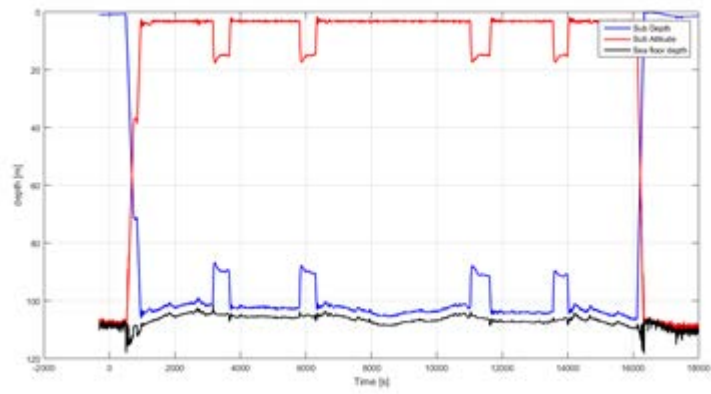
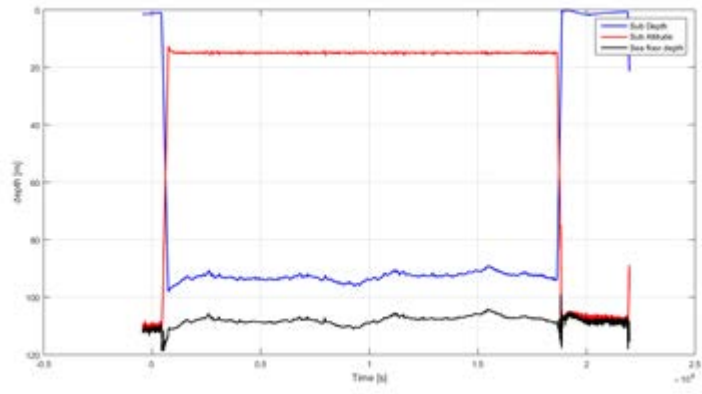

M144 Mission Summary

Campaign	JC166/7	Mission Number	M144
Operating Area	Haig Fras	Science Station No.	
Vehicle Configuration			
Sensors used		Sub configuration	
<ul style="list-style-type: none"> • RDI workhorse ADCP 300kHz downwards. • PHINS INS • Seabird 9+ CTD with dual CT sensors • EM2040 multi-beam • EdgeTech 2200-M 120-425kHz side scan and 2-16kHz sub-bottom profiler • 1 x colour downwards camera and flash • 1 x colour forward camera and flash • Tritech Seaking obstacle avoidance sonar • Sonardyne G6 USBL Transponder 		<ul style="list-style-type: none"> • Rear winglets set at 6° pitched downwards. • Autosub 6k recovery line retention system with nylon springer lines • 14.2kg positive buoyancy. • 4 complete battery packs (6 battery modules), and 1 further battery pack loaded with 5 battery modules. • Autosub6000 Lawson launch and recovery system (LARS) 	
Mission Objectives			
Night time camera survey followed by Multibeam survey with surfacing between surveys for inspection of logger health			
Mission Conditions			
	Start of Mission	End of Mission	
Time (Logger)	29-Jun-2018 21:20:35	30-Jun-2018 09:38:48	
Position (GPS)	N50:23.995 W7:43.011	N50:23.815 W7:42.765	
Sea state	Calm	Calm	
Wind speed	F3		
Battery Voltage (V)	~50V	~40V	
Mission Statistics			
Total Mission Duration	12hrs 08mins	Time on Seabed	-
Avg. Decent Speed	-0.15 m/s	Avg. Ascent Speed	0.1 m/s
Mean Ground Speed at Bottom	1.16 m/s	Distance Travelled	51.3 km (approx..)
Mean Motor Power	284.5 W	Maximum Depth	106.5 m
Mission Description			
1 - Camera Survey, 3m altitude - 4 hours			

- 2 - Surface, review camera performance and continue
- 3 - EM2040 multibeam swath survey 50m altitude, - 4 hours
- 4 - Surface, end mission and recover

Mission Waypoints

//PHOTO MISSION

WPB1 = N:50:23.717, W:7:42.722

WPB1b = N:50:22.325, W:7:42.726 //Cable exclusion zone starts

WPB1c = N:50:21.977, W:7:42.727 //Cable exclusion zone ends

WPB2 = N:50:21.275, W:7:42.722

WPB3 = N:50:21.275, W:7:42.943

WPB3b = N:50:21.933, W:7:42.947 //Cable exclusion zone starts

WPB3c = N:50:22.270, W:7:42.948 //Cable exclusion zone ends

WPB4 = N:50:23.717, W:7:42.943

WPB5 = N:50:23.717, W:7:43.179

WPB5b = N:50:22.224, W:7:43.178 //Cable exclusion zone starts

WPB5c = N:50:21.889, W:7:43.177 //Cable exclusion zone ends

WPB6 = N:50:21.275, W:7:43.179

WPB7 = N:50:21.275, W:7:43.247

WPB7b = N:50:21.876, W:7:43.245 //Cable exclusion zone starts

WPB7c = N:50:22.211, W:7:43.245 //Cable exclusion zone ends

WPB8 = N:50:22.281, W:7:43.247

WPB9 = N:50:22.639, W:7:42.789

WPB10 = N:50:23.716, W:7:42.789

//SWATH MISSION

WPA1 = N:50:21.275, W:7:43.226

WPA2 = N:50:23.818, W:7:43.226

WPA3 = N:50:23.818, W:7:43.099

WPA4 = N:50:21.275, W:7:43.099

WPA5 = N:50:21.275, W:7:42.972

WPA6 = N:50:23.818, W:7:42.972

WPA7 = N:50:23.818, W:7:42.845

WPA8 = N:50:21.275, W:7:42.845

WPA9 = N:50:21.275, W:7:42.718

WPA10 = N:50:23.818, W:7:42.718

Mission Map

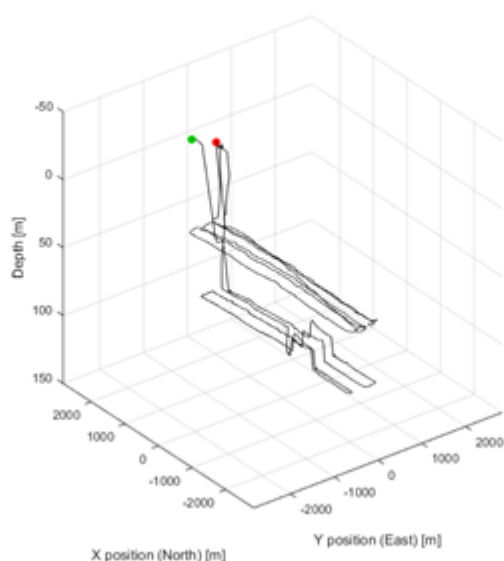

Mission Review

AUV was launched and recovered without incident. The AUV dived and performed a camera survey at ~2.5m altitude and then surfaced. The loggers and camera images were examined and found to be working although later inspection showed that the camera logger had rebooted during the descent to the seabed, however no images of the seabed were lost. The AUV then dived again and performed the multi-beam survey. This was completed successfully although inspection of the data suggests the EM2040 did not pick up the correct sound speed profile for the dive but this should be able to be rectified in post-processing. On this survey it also looked as though the AUV was affected by strong currents producing some odd tracks at the beginning and ends of the survey lines.

Initial Assessment of Sensor Data Quality

Sensor	Assessment
EM2040 – N/A	N/A
CTD, DO	OK, although some difference in sensors
Seaking Sonar	Not reviewed
Magnetometer	Not reviewed
ADCP	OK
Side scan Sonar (425kHz)	Good

Side scan Sonar (120kHz)	N/A
Sub-Bottom Profiler	Good
AESA Cameras	Failed on first camera section, good on second camera section

Faults

Fault 1 – Camera logger appeared to reboot on the descent to do the camera survey. Once rebooted though it kept going through out the camera survey.

Vehicle Performance Data

Altitude Tracking

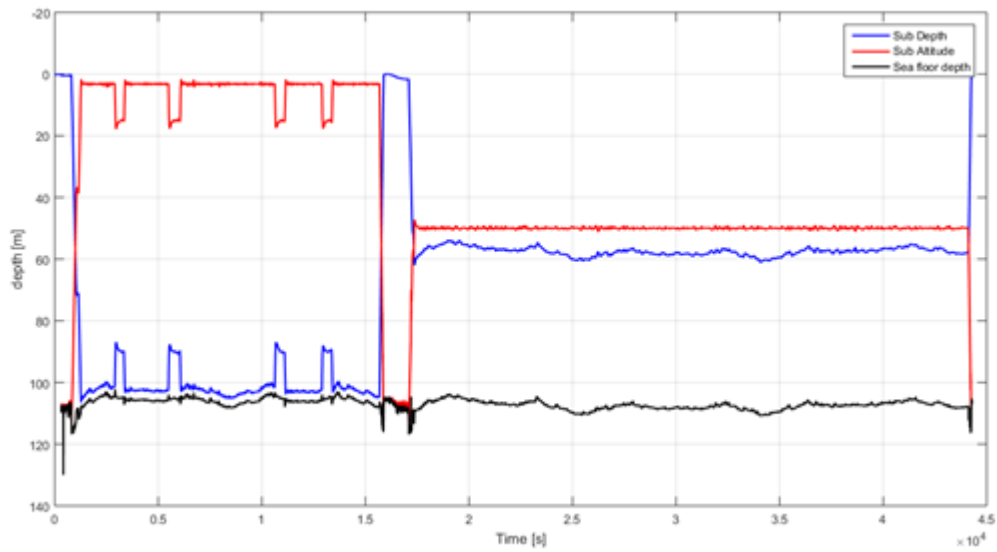

Battery Voltage

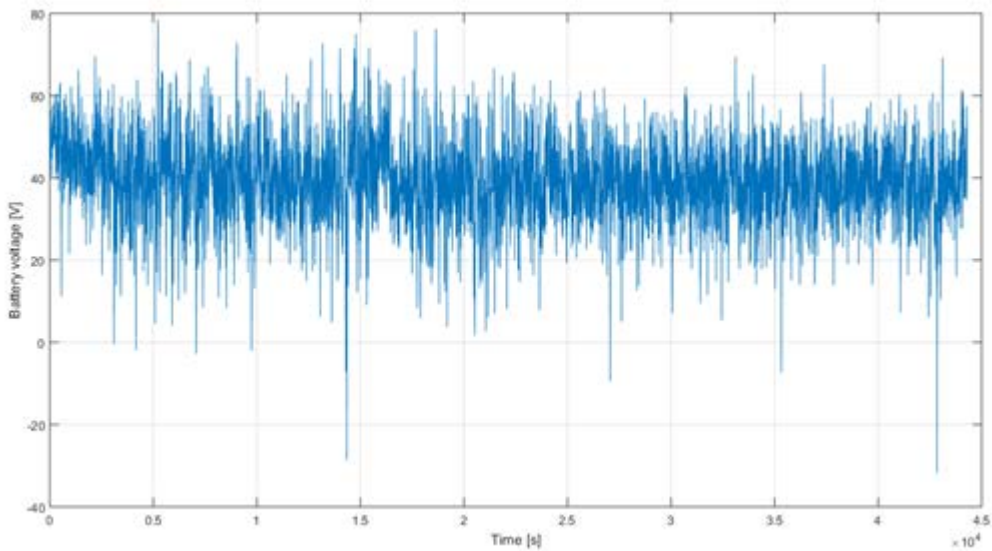

M145 Mission Summary

During the preparation for Mission 145 a number of minor faults occurred (Fault 11, 12, and 13 below) which would have resulted in a delay to the start of the mission. As the cruise programme was already time constrained it was decided to abandon M145 as a late recovery would have compromised the remain programme.

ROV

Operational Team: Dave Turner, Andy Webb, Russell Locke, Josue Viera, Stephen McDonagh

1.8. Objectives

The primary purpose of the ROV was to train new staff (both ROV and AUV team) in using the Isis ROV in real world conditions, and as a by-product to generate useful scientific data. There were also a number of secondary objectives these were:

- Steam the ROV umbilical to 4000+m
- Test the new HD Pan and Tilt camera
- Test live streaming of the Isis ROV video feed to shore as a proof of concept

ROV Dive Stats

No. of dives JC166	6 (Dive nos. 340 to Dive no. 345)
Total run time for (JC166) thrusters:	35.17 hrs
Total time at seabed or survey depth:	21.08 hrs
Isis ROV <i>total</i> run time:	4792.81 hrs
Max Depth and Dive Duration:	3876m and 1.67hrs (Dive 344) (9.32 hrs in water)
Max Dive Duration and Depth:	4.08hrs at 727m (Dive 343) (6.08hrs in water)
Shallowest Depth and Duration	97m for 3.73hrs (Dive 341) (4.52 hrs in water).

Recorded Data:

Video (4.67 TB)	DVLNAV (8.05 GB)
Techsas (1.91 GB)	CTD (45.4 MB)
OFOP Event Logger (121 MB)	Sonardyne (940 MB)
Scorpio Digital Still (10260 files, 35.3GB)	Reson Seabat (0 GB)

Master #1 Lacie Raid unit SER# (RVL0001B6CCA8B2FFA9) will be installed in the NOC media room for BODC to archive and provide access for scientists post cruise.

Backup #1 Lacie Raid unit SER# (RVL0001B6E818AE6F70) will be retained by the ROV team until BODC have archived the Master unit

1.9. Mobilisation

Southampton (NOC): 13th June to 18th June 2018 (not including weekend)

The Isis ROV system was mobilised in Southampton. This was a straight forward installation with a 9000kg installation load test carried out.

It should be noted that when control container 1 is loaded into the inboard container slot, that the lifting frame should not be used, and chains with a shortening links be used. The Jetway end needs to have the chains a couple of link shorter to help enable a more level lift.



During the lifts with the ship's large crane it was noted that the crane was struggling to render slowly when in the fine mode. Unfortunately, during the placement of the storage drum onto the bedplate, the winch came down a little too fast to control the alignment, consequently bending a couple of the base plate mounting lugs. (see pic). At this point the operations were stopped to assess the capability of the crane and capture the issue formally with the master and the superintendent. A controlled lift of 5000kg was carried out in which the crane was put into various modes to establish if the slow render capability was working correctly. It was identified that it was not working as well as it should be, and will be addressed accordingly. It was also decided that the remaining lifts to be carried out with the crane (only the traction head) could be carried out to

complete the mobilisation. Extra care and safety was implemented to avoid any issues.

It was also noted that the main crane has no safety trip to prevent the hook from 'blocking' with the head of the crane.

On completion of the hydraulic connections, and during the initial power up of the HPU it was noted that the docking head on the LARS appeared to lose some functionality. See LARS section.

Fortunately, this was repaired prior to the arrival of the water bag and the load test to be carried out on the Fri 15th June.

Due to a UKRI visit on Mon 18th June the ROV heavy consumable container was not loaded until after this had taken place. With this container not loaded and the AUV workshop positioned temporally further aft meant that there was more deck space to receive the guests.

The ship sailed at approximately 11-00hrs on Tues 19th June as scheduled.

1.10. De-Mobilisation

The ship arrived along-side at NOC on the eve Fri 6th July

Mobilisation commenced at 08-00hrs Sat 7th July.

Most lifts were completed during the Saturday, with the AUV LARS scheduled to be lifted on Mon 9th July with a shore side crane.

1.11. Operations

The main purpose of this cruise was to train the new ROV electrical/electronic post, with the addition of a couple of the AUV engineers if the schedule permitted, in the operation of the ROV system. Unfortunately, due to a fair few issues with the AUV, these engineers were required to spend the majority of their time working on their own equipment, and therefore only had limited exposure to the operation of the system.

With the dives achieved during the trial, and the tasks requested by the science party, the new recruit (Stephen McDonagh) was able to gain some valuable experience in the piloting of the vehicle and the taking of samples using the manipulators. Excellent progress has been made. In addition, a good general familiarity with the ROV system has been achieved, during the mobilisation, setting up and operation, and the decommissioning at the end of the cruise.

In addition, a change of order of staff has also been trialled for the deployment and recovery of the ROV to help facilitate future cruises.

A new HD Dome camera and a new spare Pan and Tilt unit were trialled in different configurations.

As a trial for the shallow deployments anticipated next year the opportunity to run a couple of dives at the Haig Fras site was taken. This gave a good opportunity and feel for the positioning of the vessel relative to the ROV.

- Two dives were carried out in approx. 90m depth.
- The floatation on the wire was reduced to five floats at approx. 8m apart.
- The umbilical beacon was not attached.
- A delta of approx. 30m was maintained.
- An approx. distance of 40 to 50m was maintained from the port side of the vessel.

1.12. Handling Systems

1.12.1. Hydraulic Power Unit (HPU)

Worked well for the duration of the cruise, with no problems reported.

Future modification/requirements:

- Standard post cruise checks and maintenance

1.12.2. Storage Drum/Traction Winch

Worked well for the duration of the cruise, with no problems reported.

Future modification/requirements:

- Check brake assembly.
- Slipping to be removed and the F/O part to be switched back from the unit taken out of the TMS.
 - The whole unit is to then be returned to manufactures for complete overhaul.

1.12.3. Storage Drum/Traction Winch Base Plate

Damaged during the mobilisation.

Future modification/requirements:

- Tombstone to be removed /straightened, along with supporting beam.

1.12.4. Launch and Recovery System (LARS)

Following the mobilisation, and the power up of the system it was noted that the docking head rams were not operating properly, causing the head to jam when the swing or inboard/outboard functions were operated. Initially it was thought that the one of the solenoid valves to one of the rams could be sticking. Solenoids SOV 10, 11 and 12 were replaced. This did not resolve the issue, and when the removed valves were checked on the bench they appeared to operate correctly. Following this the pilot operating valves for each ram were removed and inspected. Some of these appeared to be sticking. Valves POV 1,2,3 and 4 were replaced.

The replacement of these valve resolved the issue and the docking head functioned as it should.

Removed solenoids have been kept as useable spares.

During the removal of the test rope from the traction head it was seen that oil was spraying from a hose connection to one of the valve packs on the top of the LARS. Upon inspection, it revealed that the hose had become loose. All hoses to the manifold were tightened, resulting in the leak being sealed.

Future modification/requirements:

- Inspect sheave drive sprocket/chain.
- Check tugger wheel assembly.
- Add drive chain sprocket/chain to inspection and testing procedure.
- Standard post cruise checks and maintenance.
- Order 4 x PD12-30-0-N-110
- Order 2 x EMDV-12-N-C1-0-24DG
- Order 1 x EMDV-12-N-01-0-24DG

1.12.5. Umbilical

The umbilical was mechanically and electrically terminated and load tested after the mobilisation. A load of 7000kg was applied and held for 5 minutes.

The electrical and F/O connections were protected by an oil filled rubber hose suitable for the wire stream.

With the umbilical attached to the streaming weight, two vertical deployments were carried out to an approx. depth of 3900m. Each deployment remained at depth for one hour before starting to recover.

Deployment 1 had the ROV WMT beacon and one of the AvTrak HP beacons attached. Both tracked well for the duration of the deployment.

Deployment 2 had the ROV umbilical WMT attached, which also tracked well for the deployment duration.

Following the wire streams, the umbilical and bullet assembly was installed into the gimbal assembly of the ROV. Prior to connecting the F/O to the vehicle a quick set of attenuation readings were taken to make sure the terminations were still in good order. Unfortunately, the readings were high and one of the fibre connectors appeared to be damaged. To avoid any issues at a later stage it was decided to re make the connections.

The attenuations for each of the new fibre connections were recorded from the vehicle end to the control container patch panel.

The attenuation for each fibre was recorded as:

Black	1310:	12.84dB	1550:	10.81dB
Red	1310:	5.34dB	1550:	4.32dB
Grey	1310:	14.77dB	1550:	10.81dB

Red fibre - For vehicle telemetry

Black fibre - For CWDM (cameras)

Grey fibre – Spare

During Dive 344 just prior to coming off seabed the science camera went dark, followed shortly by the pilot and Scorpio. This was at approximately 3870m. No led lights were visible on the rattlers. At approximately 150m depth all the cameras came back to life. Following the dive the bullet was removed from the vehicle and inspected for turns. This appeared ok.

As a method of testing the CWDM fibre to see if indeed the attenuation had deteriorated a spare bulkhead connector was used to connect into the CWDM tail, removing the requirement to drain the fibre junction box from oil. The readings from the power connectors were recorded and compared to the original ones taken when the termination was made.

Black 1310: 13.59dB 1550: 12.44dB
Approximately 2db of additional losses were noted.

The spare fibre was also tested in the same way.
Grey 1310: 15.34dB 1550: 15.09dB
Approximately 1db of additional losses were noted.

As a test, both fibres were connected through to the CWDM to see which would give the best readings on the rattlers. The grey fibre gave 1 x LED for science (= from -15 to -20dBm), 1 x LED for pilot, and 2 x LED (= from -10 to -15dBm) for Scorpio. The black fibre gave 2 x LED's (= from -10 to -15dBm) for all the cameras.

As the next dive (345) was to be the last, it was decided to stick with the black fibre and to pin the termination so that it could not rotate within the docking bullet, and thus preventing any further attenuation losses within the cable from the bullet to the junction box.

The only problem with pinning the termination is that if the umbilical twists for any reason then it can present problems during the recovery and risk severely damaging the umbilical if they are cannot be removed. Due to the good weather/sea conditions it was thought that this risk was low.

In addition, it was thought that if the high attenuation was being created within the umbilical somewhere on the drum then it may present itself again during the next dive, as the wire was payed out. The next dive gave an opportunity to pay out approximately 1300m.

During the last dive no further camera issues were noted and the SDI receivers remained with suitable levels.

This would indicate that high attenuation is below the bullet and has been generated by some turns from torque in the umbilical.

The mechanical inspections carried out revealed no further issues, and fortunately the good weather/sea state meant that the turn encountered in the umbilical during the recovery of the Dive 345 was easily managed.

Following the removal of the termination from the vehicle it was inspected. No obvious turns or torque could be seen.

Future modification/requirements:

- Look at replacement umbilical.
- New jacketed F/O tails appear to behave worse than the original tails. Do not use again
- Do not make fibres before wire stream.
- Look at introducing the mk2 turns counter to the bullet assembly.

1.12.6. CCTV & Lighting

During the initial power up of the system one of the cameras was producing a flashing image. This unit was replaced. The Pan and Tilt camera also had no image, which after investigation turned out to be a failed BNC. With this connector replaced the unit worked correctly.

It has been noted that the PTZ unit has a scratched lens.

As a trial, an IP camera was installed into a couple of the camera positions to see how they might work in comparison to the existing system. This worked well and will be a good solution into replacing the existing old/tired CCTV units. Some work as to how we display and select monitors will need to be carried out.

Camera mounted to the HPU was damaged during the de-mob.

Future modification/requirements:

- Investigate new CCTV system. HD cameras over IP + IP matrix. New computer with dual display.
- Replace scratched lens. (if we have a spare)
- Take stock of spares.
- Replace/repair bracket for camera mounted to the HPU

1.12.7. Containers

1.12.7.1. Control 1

The integral fire alarm in this container was giving a fault on the ships alarm panel when connected through to the vessel. This fault was identified as a short circuit caused by the sounder alarm being connected to the smoke detector and break glass circuit. By disconnecting the sounder from the circuit the fault disappeared. This sounder is not necessary as there is already a bell alarm connected.

Future modification/requirements:

- Revise wiring.
- Remove fire alarm bell and replace with sounder. Look at reposition away from fibre connections.

1.12.7.2. Control 2

Future modification/requirements:

- CSE plate inspection to be carried out following de-mob.
- Touch up paint defect for next cruise.
- Investigate replacement containers.
- Look for more suitable chair for science possible option adjustable swivel bar stool.
- Variable LED strip lighting behind monitors.
- Repair/Replace rubber door seal

1.12.7.3. Workshop

Worked well for the duration of the cruise.

Future modification/requirements:

- CSE plate inspection to be carried out following de-mob.
- This van and spares should be linked into ships fire system.?

1.12.7.4. Spares

Worked well for the duration of the cruise

Future modification/requirements:

- CSE plate inspection to be carried out following de-mob.
- Once LUVU container fitted out with shelving move equipment used during mobilisation into LUVU to give space for spares.

1.12.7.5. LUVU

No problems reported. Better storage and method for securing the oil drums would be advantageous.

Future modification/requirements:

- CSE plate inspection to be carried out following de-mob.
- Fit some shelves and racking.

1.13. ROV External and Sampling Equipment

1.13.1. Sonardyne Beacons

1.13.1.1. Compatt 5 Midi Beacon

Not used for the duration of the cruise.

Future modification/requirements:

- Batteries to be disconnected and stored in LI battery store at NOC.
- New battery to be purchased once a cruise code has been released for next ISIS cruise.

1.13.1.2. G6 WMT Beacons

Both Beacons were tested individually on each of the wire streams prior to their use for ROV operations. Both tracked well to approx. 3900m

Beacon 2702 was used to track the ROV and 2709 was used to track the umbilical.

Beacon 2702, is trickle charged from the ROV and remained on the vehicle for the duration of the cruise. Beacon 2709 is attached to the umbilical when the vehicle is at 100m depth and the wire out is at 150m. Following each dive this beacon is charged on the bench in the workshop. This was not used for the two shallow dives at Haig Fras

A new SVP was loaded into the Ranger topside unit, at each different work area.

Both beacons tracked well with no issues reported during the cruise.

Future modifications/recommendations/maintenance

- Connect to terminal and switch off both beacons.

1.13.2. Football Floats

8 x 6000m floats were used for the duration of the cruise.

Future modifications/recommendations/maintenance:

- Check and re-tighten float latches where necessary.
- Check quantities and order replacements if necessary.

1.13.3. Suction Sampler

The suction sampler was used occasionally throughout the cruise. Unit worked well with no problems.

Future modifications/recommendations/maintenance:

- Investigate a solid pipe arrangement for the rear of the drawer to further improve suction pipe path.
- A solution to filling all the chambers without having to rotate the mechanism would be useful.

1.13.4. Push Cores

Combinations of 6 x tubes (1 box) were used for all of the dives.

Future modifications/recommendations/maintenance:

- Service units and make ready for next cruise.
- Look at an easier way to secure the boxes to the tool sled.

1.13.5. Magnetic Tubes

Combinations of 6 x tubes (1 box) were used for all of the dives. A couple of lids were lost on an early dive.

Future modifications/recommendations/maintenance:

- Replace any lost lids.

1.13.6. Niskin Carousel

Not used.

1.13.7. Reson Installation

Not used.

1.14. Isis ROV

1.14.1. Thrusters

All thrusters worked well. It would appear that the replacement of all the Subconn HP connectors has worked well removing all previously experienced Ground Faults (GF).

Unfortunately, during the recovery of Dive 344 with the vehicle on the surface a GF was detected on the forward lateral. This dive was the deepest by a long way compared to the previous dives (3876m). Post dive checks could not detect any fault. The connector was serviced ready for the next dive.

During the next dive (345) no GF's were encountered on any thrusters

Following each dive all the thruster units had their compensation oil flushed through, and were checked for bearing noise and leaking seals.

Future modification/requirements:

- All motors to be stripped with bearings and seals replaced.

1.14.2. Hydraulic System

On initial power up of the hydraulic system, a relief valve blew on the schilling arm. This was found to be caused by the valve on the hydraulic reservoir being closed. This is most likely to have been from the system was used back in the hangar on its deck hydraulic supply when the valve needs to be shut. Following this, it

was noted that the comp pressure gauge was not working, and then appeared to start working again on the second power up.

For all subsequent use the hydraulic system worked well with no further issues. Following each dive an oil sample was taken from the reservoir and inspected for water ingress. All samples appeared free of water.

For the deep dives over 3000m the hydraulic pump was run for the duration of the dive. Some pressure was applied and the manifold activated. This was a recommendation from WHOI to prevent water ingress that has previously been an issue. This appeared to work well with no water ingress observed.

Future modifications/recommendations/maintenance:

- Flush oil system and change all filters.
- Service all hydraulic motors and actuators.
- Keep an eye on comp pressure sensor

1.14.3. Manipulators

1.14.3.1. Kraft Predator

Following the deep dive (344) to 3877m it was noted during the next pre-dive that the Elbow Pitch was not working correctly and was showing signs that the potentiometer was failing. As the next dive (345) was the last one for the cruise and was limited to only a few hrs, it was decided that a repair was not possible and that the arm would remain un-used for the dive.

A calibration on the wrist rotate may be required. On occasions the wrist will rotate freely unless locked and controlled from the rocker switch on the master.

Future modifications/recommendations/maintenance:

- Service Jaws
- Flush compensation oil
- Clean and inspect for corrosion/oil leaks
- Replace EP Potentiometer

1.14.3.2. Schilling T4

Worked well for the duration of the cruise.

Future modifications/improvements/maintenance:

- Perform visual inspection of Schilling T4.
- Flush compensating oil.
- Remove camera and lights in preparation for $\geq 4000\text{m}$ dives (check next cruise requirements)

1.14.4. Tool sled

Worked well for the duration of the cruise.

Future modifications/improvements/maintenance:

- None.

1.14.5. Vehicle Compensation System

The vehicle main compensation system worked well for the duration of the cruise. Following each dive oil samples were taken from each junction box, to check for water ingress.

Future modifications/improvements/maintenance:

- Visual inspection of transformer gasket, to make sure new gasket is sealed correctly.
- Check all comps for cracks and general wear.
- Inspect compensator hoses for splits and UV damage and replace if necessary.

1.14.5.1. Thruster Compensators

The thruster compensators worked well with no faults.

Future modifications/improvements/maintenance:

- Perform visual inspection of compensators for leaks/damage.
- Inspect compensator hoses for splits and UV damage and replace if necessary.

1.14.5.2. Manipulator Compensators

The manipulator compensators worked well with no faults. Neither Schilling nor Kraft compensators lost any significant amount of oil during dives.

Future modifications/improvements/maintenance:

- Perform visual inspection of compensators for leaks/damage.
- Inspect compensator hoses for splits and UV damage and replace if necessary.

1.14.6. Pan & Tilt Units

The new spare Kongsberg unit was installed into the pilot camera position. This worked well. The other unit was used for the science P&T, again working without any problems.

Future modification/requirements:

- Development project to produce a new camera controller that communicates with the P&T units

1.14.7. Cameras

1.14.7.1. Mini Zeus HD (pilot & science)

Following the last cruise when the new (spare) Zeus was tested, it was identified that some heat treatment was required to remove the small amount of condensation. This heat treatment being the drying of the camera in an oven and then re-assembling in dry conditions. In an attempt to find a better way to keep the camera dry and free from condensation, the unit was opened, the lens assembly removed, and the dome port cleaned. The unit was then re-assembled, back filling the spaces with Nitrogen. Previously the lens and dome assembly had not been opened, and therefore unlikely that the oven treatment had made any difference.

This new process worked well and no signs of condensation were noted during any of the dives.

For the first couple of dives the pilot Zeus and P&T were removed from the vehicle so as to make space for the new Kongsberg HD Dome unit.

For the third dive the HD dome unit was removed and two Zeus cameras were used in the pilot and science configurations.

For the remainder of the dives the Science Zeus and P&T unit were removed to make space for the HD Dome camera to be used in the science location on the vehicle (up high on the light bar)

Future modification/requirements:

- Wash and stow units in draw.

1.14.7.2. HD P&T Dome Unit

The new camera was originally intended to be used by the pilot and located in a central low position on the vehicle, replacing the Pilot Zeus and P&T unit. Unfortunately, the field of view on this unit is considerably lower than the Zeus camera making it much more restrictive for the pilot to use. In addition, it also appeared a little too much zoomed in. Picture quality also not as sharp as the Zeus units.

After trying the unit in the pilot configuration, it was decided to try the unit in the science location. This worked a little better and was more use when used for manipulator functions. It is questionable as to whether or not it is such a good option for the science.

During Dive 343 some water droplets were seen on the inner dome. The vehicle was at approximately 550m. Some pics of the monitor were taken at the time. Upon post dive inspection it was not evident that any water was in the dome. On the next dive (dive 344) again at around 500m it appeared that some condensation could be present.

Future modification/requirements:

- Talk to Kongsberg to see what can be done about field of view.
- Question the picture quality with Kongsberg.
- Question the white balance options (indoor/outdoor)!!
- Send pics and depth at which point water droplets were spotted on the dome to Kongsberg.
- Wash and stow unit in draw.

1.14.7.3. Scorpio

Both Scorpio units have been used over the last two deployments. JC165 used one (SSC103), and this cruise the other SSC102.

Unit SSC102 had the same treatment as the new mini Zeus, with the lens removed, dome cleaned and back filled with Nitrogen. This unit was used in the fixed forward facing position on the ROV. No condensation was observed after any of the dives.

If the unit was not used for a couple of days, the battery will run flat and the camera on power up will go to the factory defaults.

Future modification/requirements:

- Investigate if Scorpio CX560VE battery can be replaced (NP-FV50=default, FV70 or FV100)
- Replace battery

1.14.7.4. Tooling Cameras

All tooling cameras worked well with no issues reported.

These are positioned in the following locations:

Draw down looking	bullet upward
gauges/suction sampler	Niskins

Future modification/requirements:

- Investigate tooling camera replacements
- Replace drawer camera with a new unit to improve quality.

1.14.8. Lights

1.14.8.1. DSPL Multi Sealite (LED)

All the units functioned well with no faults recorded.

These are positioned in the following locations:

Aux – side of draw bullet up looking
Draw down looking gauges/Suction Sampler
2 x aft facing

Future modification/requirements:

- Acquire more LED spares.
- Acquire more Y-Slice leads.

1.14.8.2. Aphos 16 LED

The four units used on this deployment, are the last to have been returned to Cathx for their upgrade. All the units worked well with no issues.

Future modification/requirements:

- Look at serial port connection for dimming option
- Inspect wiring harnesses and replace where required.

1.14.9. Lasers

1.14.9.1. NOC Lasers

The NOC lasers were mounted onto the Scorpio stills science camera. No faults occurred during the duration of the cruise.

Future modifications/improvements/maintenance:

- Perform visual inspection of lasers. Check and re-grease o-rings as required.

1.14.9.2. Sidus Lasers

Used on HyBIS for the previous deployment (JC165). Mounted on HD science camera for JC166. When HD Dome camera was installed in the science position, the lasers were mounted at a fixed angle below the camera. No faults occurred during the duration of the cruise.

Future modifications/improvements/maintenance:

- Perform visual inspection of lasers. Check and re-grease o-rings as required.
- Only 3 x complete working units left.
- Consider replacing Sidus lasers with NOC lasers on ISIS.

1.14.10. CWDM F/O Multiplexor

Worked well for the duration of the cruise.

Future modifications/improvements/maintenance:

- Check spare stock of F.O. Rattlers.
- Acquire a spare long F.O. patch lead.

1.14.11. Sonars

1.14.11.1. Doppler

This unit worked well for the duration of the cruise

Future modification/requirements:

- Consider a training course for some of the team members.

1.14.11.2. Altimeter

This unit worked well for the duration of the cruise

1.14.11.3. Trittech Imaging

This unit worked well for the duration of the cruise.

Future modification/requirements:

- Check oil levels in sonar head.

1.14.11.4. Digiquartz Pressure Sensor

The unit worked well for the duration of the cruise. We need to decide how long between calibration periods.

1.14.12. CTD

Worked well for the duration of the cruise.

Future modification/requirements:

- Return CTD for calibration

1.15. ROV Topside Systems

1.15.1. Jetway

Worked well for the duration of the cruise.

Future modification/requirements:

- Inspect all A/C units and consider renewing A/C gas.
- Ongoing investigation of replacement Jetway.

1.15.2. Monitors

One of the backbench monitors for science died during the mobilization. One of the Hybis monitors was used as a temporary solution.

Future modification/requirements:

- Replace the three monitors with new 24" monitors with HDMI, VGA and DVI inputs.

1.15.3. Promise Pegasus R6

One of the units died and does not power up.

Future modification/requirements:

- Buy spare hard drives.

1.15.4. Clearcomm

The new wireless system was trialled on this cruise. The volume on the wireless headsets seemed to be lower than that of the wired headsets and when both the headset mics were enabled the background noise of the winch was increased making it still harder to hear commands from inside the ROV control van.

Future modification/requirements:

- Contact supplier to revise the configuration.
- Investigate replacement or better quality headsets

- Stand-alone mic for positioning between the pilot and engineer.

1.15.5. New HP Prodesk 400 mini PCs

Several units were fitted to replace the old HP G5 that have been working for the last 8 years on the Control Van. They have performed well, with no issues related to software problems, as well as reducing the noise and heat dissipation.

Future modification/requirements:

- Buy spare HP unit.
- Buy spare hard drives for backups
- Do backup of all computers (including HP G5 and G6).
- Buy a development HP unit for software tech.

1.15.6. HP G5/G6 Computers

Some machines have been serviced and fitted as spares on the sound rack in the Control Container #2. They act as potential spares for the Topside, Techsas. A spare G6 unit is also available as a spare for the Database or the Ranger 2 machine.

1.15.7. Topside PC

Performed correctly. Still using old HP G5 machines.

Future modification/requirements:

- Software tech needs to develop new topside code that uses MOXAs instead of old legacy/EOL Digiboxes.
- Move Topside software to new computer.

1.15.8. Database PC

The Database computer crashed during the first days of the cruise. The hard drive completely died, being replaced with a spare unit with a previous backup. It was then updated to the latest dive number. Intermittently, the database will not get Isis feed neither the ship's, so information was not being correctly filled in the logbook.

Future modification/requirements:

- Software tech needs to check the database code.
- Software tech needs to migrate the database software + Linux living in old HP G6 computer to one of the new HP Prodesk mini.

1.15.9. Overlay Data Display

During first dive was not working. After some diagnose and checking the COM Port of the computer, it was found that the serial lead was disconnected on the back connector of the patch panel. During the rest of the dives it did not showed correctly the information since the database software was not working correctly.

Future modification/requirements:

- Software tech needs to modify code to include the altimeter but not big compass.

1.15.10. OFOP Science PC

A new Labview display was incorporated to the OFOP computer, since science required a quick information feed for ISIS USBL position and depth for their paper logs.

1.15.11. CLAM PC

New version of CLAM was tested, developed by Josue modifying the latest version of CLAM from the ship. This new version was running in parallel with the old software to compare them. Some tweaking was done to reduce the lag.

1.15.12. Device Controller PC

The Kongsberg was installed and configured to use one of the joysticks to control the new HD P&T Dome Camera. During the days were no dives were planned, a new Labview module was developed and briefly tested to be able to integrate the control with the Isis joybox. This was later modified to test the new gamepad controller that will possibly replace the Logitech wireless joystick controller used for science, since this unit is obsolete and EOL.

Future modification/requirements:

- Acquire additional gamepad controller.
- Modify Labview code of existing P&T units to incorporate new gamepad and smoother operation.
- Change Labview code to map different controllers and select which P&T units/Camera to launch.

1.15.13. Sonardyne PC

The computer failed during the mobilization. One of the fans was replaced and no further issues. Since this machine is an old W7 G6 machine, during the last dive (345) of JC166 the Sonardyne software was trialled on the spare HP Prodesk mini machine. The latest version was installed and configured on the W10 machine. The firmware of the hardware NSH unit had to be also upgraded to the latest version. The software performed correctly, tracking both beacons with no issues or lag.

Future modification/requirements:

- Procure a dual dedicated Ethernet port computer for the new Ranger 2 (e.g., Steatite rack unit used by Ship Systems)
- Read documentation to remove the "S xxx" on the display from the beacon info.

1.15.14. Techsas

This software still runs on an old HP G5 machine. The version being used is an old one (V 2.0), while the ship systems have an improved later version (V 5.0) running on the ships.

Future modification/requirements:

- Software tech needs to migrate + upgrade the CentOS Techsas living in old HP G5 computer to one of the new HP Prodesk mini.

1.15.15. QNAP

The X-serve has been written off and replaced with a QNAP for the dive data storage. This unit performed excellent.

Future modification/requirements:

- Buy spare 3TB hard drive.

1.15.16. Workshop PC

Worked well.

1.15.17. iMacs

Science used the iMac with the Final Cut Pro software to access the video and data stored on the Lacie units.

Some science users complained that in previous cruises, some of their USB sticks seemed to corrupt due to the connection from an Apple computer to a Windows computer. This issue is probably related to the incorrect disconnection of the device without “ejecting” it on Operating System of the Apple computer.

Future modification/requirements:

- Buy a small 2.5” hard drive for data transfer.

1.15.18. Prizm

Work correctly.

Future modification/requirements:

- Need to consider complete replacement system as no spare boards are available.
- Investigate possibility of relocating the PRISM unit so that connections are more accessible.

1.15.19. Joybox

Worked correctly and no further power off issues have happened after the earthing of the case performed some cruises ago.

Future modification/requirements:

- Try to backup Hard drive inside unit.
- Replace Z thruster on Joybox unit #3.
- Acquire two Z thruster joysticks.
- Acquire 1 x XY and rotation joystick
- Start a development project to produce a joybox that communicates with topside.

1.15.20. Network Time Protocol (NTP) Server

This unit performed correctly. No more loosing lock issues have aroused after the firmware upgrade done after talking with the manufacturer prior to this cruise.

1.15.21. ROV video streaming test

This cruise had an optional objective of trialling a video streaming back to NOC of the ROV cameras. This is now possible due the new higher upload speed on the ship.

The first test was using the existing PAL Axis video server connected to the Scorpio camera. This stream is converted by one of the Ship Systems machine and uploaded to the streaming server. This method requires a dedicated computer and the quality is low since the origin is a PAL feed.

The second test was using the existing the ROV Ultrastudio Blackmagic box which is actually not used since it needs a firmware upgrade from the manufacturer to use the ProRes codec. This unit was then connected to the existing Mac Mini and the OBS software was installed and configured to do the video stream to server. This approach prevented Science doing the periodic tape transfer to the Lacie units since the thunderbolt had to be used for the Ultrastudio unit instead of the Ki Pro cartridge caddy. Quality should be better since it is now using an HD feed, but again this method requires of a dedicated Mac Mini with the OBS software to do the process and upload.

If this process is to be carried out in the future, a dedicated HDMI encoder box can be procured, configured and tested, being more cost effective and smaller footprint that the two above options. It will also be necessary to characterize the impact on the Ship’s broadband connection, and study the working uptime due to the usual satellite connection losses.

On another hand, streaming the ROV video footage arouses data protection and science conflict issues, which will need to be discussed and approved by the different parties involved.

Isis ROV Dive Hr Summary

Cruise No.	Dive No.	Dive Hrs Decimal	Dive Hrs:Mins:Sec	Cruise Total Hrs Decimal	System Total Hrs decimal	Max Depth (m)	Bottom Time Hrs:Mins:Sec	Bottom Time (Hrs Decimal)
JC166								
	1 340	6.233	6:14:00			388	5:12:00	5.20
	2 341	4.517	4:31:00			97	3:44:00	3.73
	3 342	4.617	4:37:00			98	4:00:00	4.01
	4 343	6.083	6:05:00			727	4:05:00	4.08
	5 344	9.317	9:19:00			3876	1:40:00	1.67
	5 345	4.400	4:24:00			1219	2:23:00	2.38
JC166 Totals	6	35.167	35:10:00	35.17	4792.81	3876	21:04:00	21.076

HyBIS System Cruise Report

Operational Team: Dave Turner, Andy Webb, Stephen McDonagh, Josue Viera & Russell Locke



Fig. 3.1 HyBIS on deck

1.16. Cruise Outline

HyBIS was used during JC166 to cover a couple of short video transects whilst the AUV prepared to cover its science objectives. The initial plan was to cover some training using the manipulator and bucket grab. Unfortunately, this did not get completed as the vehicle had encountered some thruster issues on the previous cruise. It was then decided that the time would best be spent to fault find the issue so that suitable measures could be put in place to cover the forthcoming cruise of DY094.

1.17. Stats

No. of dives JC166 (Dive nos. HY28 to HY29)	2
Water Depths	80 – 85m
Total time at seabed or survey depth:	2:43 hrs
HyBIS <i>total</i> run time:	3:27 hrs
Total Video (Apple ProRes 422)	HD 153.28 GB PAL 125.4 GB
Scorpio Images	1729 images – 6.51 GB

Master #1 Lacie Raid unit SER# (RVL0001B6CCA8B2FFA9) will be installed in the NOC media room for BODC to archive and provide access for scientists post cruise.

Backup #1 Lacie Raid unit SER# (RVL0001B6E818AE6F70) will be retained by the ROV team until BODC have archived the Master unit

1.18. Mobilisation

The HyBIS system remained on board the RSS James Cook after JC165 for JC166-JC167 ROV Trials, so there was no mobilisation for JC166-JC167.

1.19. De-Mobilisation

Southampton (NOC): 7th July to 9th July 2018

The HyBIS system was demobilised in Southampton.

1.20. Deep Tow Cable

1.20.1. Umbilical Termination

The deep tow cable termination was reused from the previous JC165 cruise.

Power meter readings from the termination end of the deep tow to the F.O. JB located in the main lab:

Red	1310:	-14 dBm 7dB	1550:	-16 dBm 9dB
Grey	1310:	-15 dBm 8dB	1550:	-17 dBm 10dB
Black	1310:	-19 dBm 13dB	1550:	-24 dBm 17dB

Suggestions/Recommendations

- Check stock of Evergrip terminations, fibre optic components, electrical cable crimps and re-stock as required.

1.20.2. High Voltage Operations

Prior to the cruise the HV operations were discussed and agreed with the James Cook Master. It was agreed that the Hybis HV responsible person would take responsibility of the HV cage keys throughout the cruise. Hybis would not be operated using HV on deck and would be powered up and powered down and earthed at 20m depth. The bridge was notified via VHF radio each time Hybis was turned and powered down.

A permit to work/Isolation certificate was filled out at the end of each dive to show that the vehicle was isolated and HV probes were used each time the HV JB was opened.

At the end of the cruise the chief engineer was given the isolation certificate detailing the work carried out to make the system safe, and conformation that all HV gear had been removed from the vessel. The deep tow umbilical was left with all earth spiders connected and fully discharged in the correct manner.

Suggestions/Recommendations

- None

1.21. Vehicle

1.21.1. Hydraulic System

Following the previous cruise, the Hydraulic compensator was removed and replaced with a spare. No sign of any leaks were recorded when the hydraulic system was used and the arm and draw activated during the two dives.

Suggestions/Recommendations

- Test schilling comp that has been removed.

1.21.2. Thrusters

1.21.2.1. Thruster 001

Thruster 001 was tested first by disconnecting and removing it from HyBIS along with the motor controller tube. The first test was carried out by applying voltage to thruster 001 and bringing the speed up gradually. The thruster only ran for a few seconds before tripping the motor controller. It was from this test that the error fault code could be seen on the motor controller display. The error read ER003 which corresponded to an overcurrent fault.

A test was then carried out on the motor windings and connector lead. An ohmmeter was used for this test. The connector lead past the test and was therefore not the issue. An ohmmeter was then used to test the motor windings in which a very low resistance of 286Ω was measured across windings 1 and 2. This was a definite conclusion that the motors insulation has degraded to the point that the two coils are short circuiting.

Table 3.1 Thruster 001- Tested using an Ohmmeter

1-1	10.6 Ω
2-2	10.6 Ω
3-3	10.6 Ω
1-2	286 Ω
1-3	2M Ω
2-3	2M Ω

1.21.2.2. Thruster 002

Thruster 002 was tested first by disconnecting and removing it from HyBIS along with the motor controller tube. The first test was carried out by applying voltage to thruster 002 and bringing the speed up gradually. The thruster only ran for a few seconds before tripping the motor controller. It was from this test that the error fault code could be seen on the motor controller display. The error read ER003 which corresponded to an overcurrent fault.

Two more tests were then carried out on the motor windings and connector lead. An ohmmeter and insulation resistance tester were used for these tests. The connector lead past both tests and was therefore not the issue.

An ohmmeter was then used to test the motor windings in which a very low resistance was measured between all windings. It also failed the insulation resistance test in which infinitesimal readings were measured. This was a definite conclusion that the motors insulation has degraded to the point that all coils are short circuiting.

Table 3.2 Thruster 002 - Tested using an Ohmmeter

1-1	10.5 Ω
2-2	12.1 Ω
3-3	10.5 Ω
1-2	180 kΩ
1-3	180 kΩ
2-3	15 kΩ

Table 3.3 Thruster 002 - Insulation resistance test @ 500V

U-V	0.065 MΩ
U-W	0.063 MΩ
V-W	0.013 MΩ

1.21.2.3. Thruster 005

Thruster 005 was tested first by disconnecting and removing it from HyBIS along with the motor controller tube. The first test was carried out by applying voltage to thruster 005 and bringing the speed up gradually. The thruster only ran for a few seconds before tripping the motor controller. It was from this test that the error fault code could be seen on the motor controller display. The error read ER003 which corresponded to an overcurrent fault.

Two more tests were then carried out on the motor windings and connector lead. An ohmmeter and insulation resistance tester were used for these tests. The connector lead past both tests and was therefore not the issue.

An ohmmeter was then used to test the motor windings in which a very low resistance was measured between all windings. It also failed the insulation resistance test in which infinitesimal readings were measured. This was a definite conclusion that the motors insulation has degraded to the point that all coils are short circuiting.

Table 3.4 Thruster 005 - Test using an Ohmmeter

1-1	10.6 Ω
2-2	10.6 Ω
3-3	10.6Ω
1-2	∞Ω
1-3	∞Ω
2-3	∞Ω

Table 3.5 Thruster 005 - Insulation resistance test @ 500V

U-V	0.0997 MΩ
U-W	210 MΩ
V-W	80 MΩ

Suggestions/Recommendations

- Thrusters 001, 002 and 005 must be sent away for the windings to be refurbished or replaced.

1.21.3. Modules

1.21.3.1. Sampling

The sampling module was used throughout JC166-JC167. The module was fitted with a Super Scorpio HD camera, two Cathx Aphos lights and two Sidus scaling lasers.

1.21.3.2. Downward video

Not used this cruise.

1.21.3.3. Grab module

Not used this cruise.

1.21.4. Cameras

A Super Scorpio HD camera with Sony HDR-CX560V was borrowed from the Isis ROV equipment. Unit Serial# SSC102 was mounted onto HyBIS, unit that was purged at NOC and needed testing.

The download of images (12 megapixels) required removal of the camera for connection to the main lab control computer and video display. Download time to the computer is 30 minutes for 10 GB.

During operations, the Scorpio camera was white balanced to the seabed in the absence of a suitable white surface. This appeared to work sufficiently well to provide realistic image colours.

Two Bowtech PAL cameras were used throughout JC166-JC167.

Suggestions/Recommendations

- Investigate if Scorpio CX560VE battery can be replaced (NP-FV50=default, FV70 or FV100)
- Change jubilee clip next size up from 150/180.

1.21.4.1. Super Scorpio Specs:

HD: 1920 x 1080 / (50P), 50i, 25p

12.3 MEGA-PIXEL quality for Ultra-High Definition (4672 x 2628-pixel) Still Images

Sensor: Exmor Back-illuminated CMOS 1/2.88" (6.2mm)

10X Optical Zoom Lens (26.3mm - 263mm in 35mm format)

Focal Distance= f= 3.8mm – 38mm

Aperture: F1.8 - F9.6

64GB Internal Flash Memory

On recovery deck download of images (Ethernet deck cable)

1.21.4.2. Lights

For dives with the sampling module, two forward facing Cathyx Aphos lights were used along with two DSPL Halogen matrix lights for draw and upward lighting.

- Consider purchasing DSPL LED Matrix lights for HyBIS when budgets allow, to replace existing halogen lamps. This will help reduce total current drawn by the vehicle and the need to borrow ISIS LED lights for each cruise.

1.21.4.3. Scaling Lasers

Two Isis ROV Sidus lasers were mounted to the HD Scorpio camera to provide 10cm scaling. These were connected to the switch controlled power supply used for the UHI experiment.

Suggestions/Recommendations

- Check laser bodies for corrosion

- Strip laser to check/replace o-ring seals.
- Either keep as HyBIS lasers or return to ISIS spares.

1.21.5. Valeport VA500 Pressure / Altimeter transducers

After the new settings made on JC165, the unit performed correctly and now outputs data with a good refresh rate (2 Hz). When hydraulics are used, the noise will interrupt the data stream. Once the hydraulics are turned off, the unit will restart outputting the depth and altitude.

Suggestions/Recommendations

- Electrical Interference within HyBIS has been a consistent problem and requires redesign with improved housekeeping to minimise this problem.
- Consideration to upgrade fibre optic multiplexor to provide additional RS232 channels

1.21.6. Tritech Sonar

The HyBIS Tritech Super SeaKing DST sonar (S.N. 244116) was used once during dive HY29.

1.21.7. Compass

Hybis is fitted with an Xsense MTi-30 AHRS is a full gyro-enhanced Attitude and Heading Reference System (AHRS). It outputs drift-free roll, pitch and true/magnetic North referenced yaw.

The Xsens is a complex device that requires a calibration process to truly reflect its accuracy within its working location. This had not been achieved before the cruise so differences between ship heading with the vehicle on deck and offsets of USBL tracks were made in the control software data display. (-50 degrees).

Suggestions/Recommendations

- Investigate and calibrate compass with Xsens software.

1.21.8. Telemetry Tube

For dive HY28, the halogen lights were fitted on the sampling module. On power up, both the halogen and the Cathx lights were “strobing”, gradually increasing and decreasing their intensity. On first thought, it could be possible that the Cathx lights had change mode, so they were disconnected. After power up, the halogens still had this behaviour. The inverse was then done, leaving only the Cathx connected, but the issue still persisted. It was also noted that the Xsens and the PAL cameras feeds were not being displayed on the main lab screens, while the Scorpio and altimeter were correctly being displayed on the main lab.

The voltage was measured on the three pin connectors and it was detected that there was a gradual oscillating voltage on the Live and neutral pin, while 115V were between either of the pins and Earth. After discussion, it was thought that the ship electrical system could have changed between cruises. Talking to the ETO, he checked their systems and were fine. He confirmed that the ship 240V system should be 240V between the Live and Neutral, 115V between Live and Earth, and 115V between Neutral and Earth.

Since no progress was done after some more tests, it was decided the problem could rely on the switching relay of the telemetry tube. The tube was removed from Hybis and placed in the electronics workshop. Relays were checked and the connections. On the fault finding process, it was noted that one of the jacking screws was touching the DC output of the 24V power supply. Some insulation was added and the power supply was repositioned in the tube.

Upon power up on the lab with a halogen light connected, the problem had disappeared. The telemetry tube was mounted back on Hybis and a deck test was performed. This proved the issue had

been resolved and all the light system worked now correctly, as well as all the sensor information was received.

1.22. HyBIS Topside

1.22.1. Lab Setup and Rack Mount Case

The rack unit was upgraded to a more compact version to facilitate transport and have integrated new W10 computers (Fig. 3.2).



Fig. 3.2 HyBIS topside set-up

1.22.2. Mini HP GUI Machine

This computer provides monitoring and control of the vehicle. National Instruments Labview code provides for vehicle status displays:

- Heading & attitude
- Turns count
- Pressure
- Altimeter
- Data logging (1 second time stamped UTC)
- Ship and vehicle USBL position via ship UDP and Sonardyne Ranger 2 telegram respectively.
- UDP data broadcast for HD video overlay.

3rd party software

- Insite GUI and virtual ethernet device server – Scorpio camera control and image download
- Seanet Pro - Tritech obstacle avoidance sonar
- Chrome/Firefox – network configuration of AJA KiPro video recorders

1.22.3. Mini HP OFOP Machine

The OFOP PC was provided along with a second monitor for science logging of ocean floor observations and positioning. Real-time input of ship and HYBIS positions from ship UDP broadcasts.

1.22.4. AJA KiPro video recorders

Two AJA Rackmounted KiPro units were used to record video, as well as a third unit taken as a spare unit.

The Top unit is assigned to the Scorpio HD camera. This feed comes from the overlay, so the user can switch it ON and OFF when required. The overlay has the raw Scorpio SDI signal via a CWDM frequency receiver.

The 2nd unit is connected to the 720P50 quad which has the two PAL tooling cams.

The Apple ProRes 422 codec was employed for all recordings. Approximately every 2 hours during the dive the local cartridge disks would be transferred to the Lacie drives.

1.22.5. HD Video Overlay

The HYBIS video overlay allows the HYBIS topside system to show real time data in one of the HDMI video feeds. The data can come directly from the vehicle or from the ship, GPS or other scientific sensors.

During the cruise this performed well.



Fig. 3.3 A typical 1080i with overlay framegrab

Suggestions/Recommendations

- Investigate IIC error software bug
- Modify code to include the altimeter but not big compass.

1.22.6. Other Devices

1.22.6.1. Topside Fibre optic multiplexor

This 1U unit houses the fibre optic multiplexor with a Focal 907 board and associated power supplies. Connections provided for serial devices and Hydrolek control interface for lights, thrusters, hydraulics and lasers.

1.22.6.2. UPort 16 port USB RS232 / RS485

This unit provides the GUI PC with a USB serial expansion to read the sensors data from the Topside Fibre optic multiplexor.

1.22.6.3. Netgear 8 port switch

This unit provides ROVNET connection for all network devices.

1.22.6.4. Moxa 2 port serial connected to Shipnet

This unit reads the Sonardyne beacon from the ship and forwards it to the Moxa 4 port.

1.22.6.5. Moxa 4 port serial to ROVnet

This unit provides for network virtual serial com ports and UDP broadcast. Receives a serial feed and broadcast the info into ROVnet.

1.22.6.6. Displays

Two Dell 27" monitors for the computer displays and two 28" Samsung TV's mounted on a bespoke frame provide for display of video and PC's.

A 23" monitor was used as a second extended display for OFOP for science use to log data and events into the software.

A 24" HDMI monitor was used for the Apple mini mac.

A CCTV monitor to display the winch CCTV feed for the Winch Operator was supplied by the ship.

1.23. Football Floats

Two football floats were attached to the umbilical prior to the launch and an additional three were added when the vehicle was at 20m .

1.24. Sonardyne Beacons

A ship supplied WMT beacon was used for each deployment and routinely charged by the NMF Tech. This provided very good tracking throughout the cruise. The Ranger 2 software was configured with a UDP telegram to output the vehicle position for inclusion in the HyBIS OFOP and data display.

Wave glider

Operational Team: Stephen Woodward, Mike Smart, Terry Wood

1.25. Objectives

The objectives for the Waveglider trials were to test the launch and recovery procedures of the vehicle from the *RRS James Cook* using the Man Over Board (MOB) workboat, and to test the performance of the Sonardyne acoustic modem installed on the Waveglider.

1.26. Waveglider Mission 1

The Liquid Robotics (LRi) SV3 Waveglider 026 'Waimea' was deployed for a short shakedown trial, and to test the launch and recovery procedure from the *RRS James Cook*.

1.26.1. Waveglider Payload:

- Seabird GPCTD s/n 0105-7305
- Seabird SBE43 dissolved oxygen sensor s/n 0105-7305
- RDI 600kHz ADCP s/n 19375
- Airmar weather station s/n 2922486
- Airmar water speed sensor s/n 2598788
- Sonardyne 9522B acoustic modem s/n 288-081-001

1.26.2. Deployment Description

The waveglider was deployed at Haig Fras (station 26), on the 27th June 2018, at 11:00 UTC (50° 22.478N, 07° 41.469W). The water depth was 103m and the weather conditions were good, wind 18 knots @ 090°.

The Waveglider was deployed 1 mile East of the ALR Echosounder deployment location, and directed West and then into a holding pattern of 6 waypoints (1-6) spaced 250m from a central point (waypoint 251; Fig. 4.1).

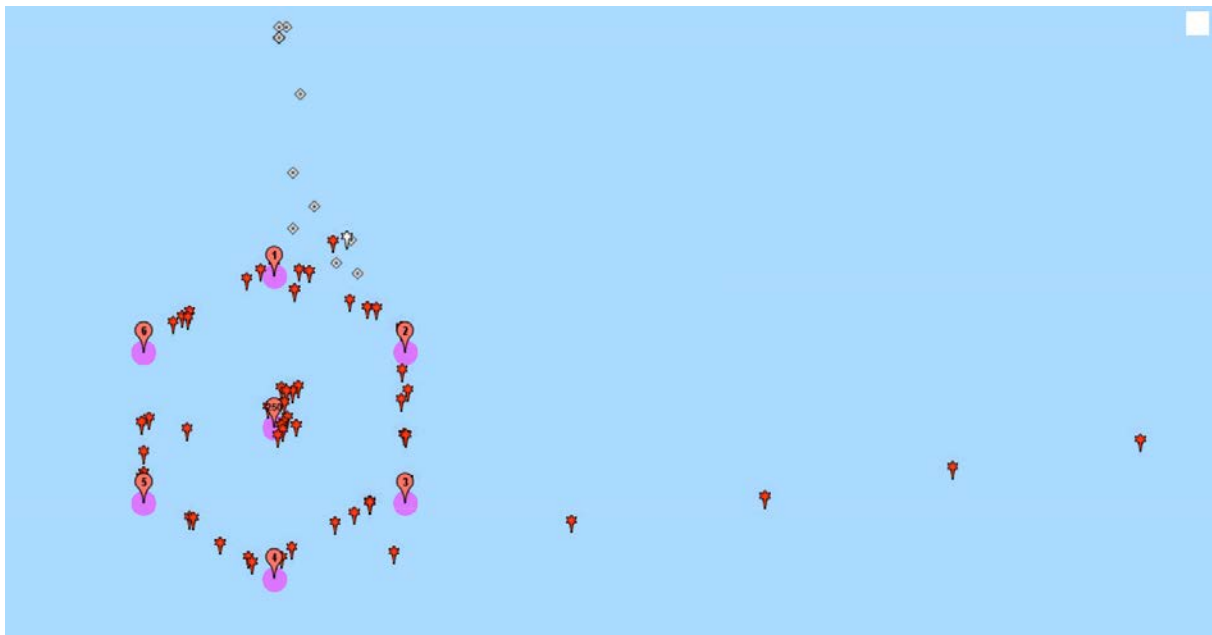

Fig. 4.1 Waveglider holding pattern on 250m radius (using PID line-following)

The Waveglider was deployed off the stern using the starboard deck crane (Fig. 4.2). The vehicle was released using a Seacatch and the sub unit was deployed using a quick-release ratchet strap. However, the deployment was made difficult by the lack of strengthening bracket on the 'pod' housing the GPCTD sensor underneath the sub unit. This forced the quick-release ratchet strap to be fastened near the rear of the vehicle, and led to the two parts working free before reaching the water. The deployment was successful in this case, but this issue could easily have led to problems, and is likely to be especially challenging in rough weather.

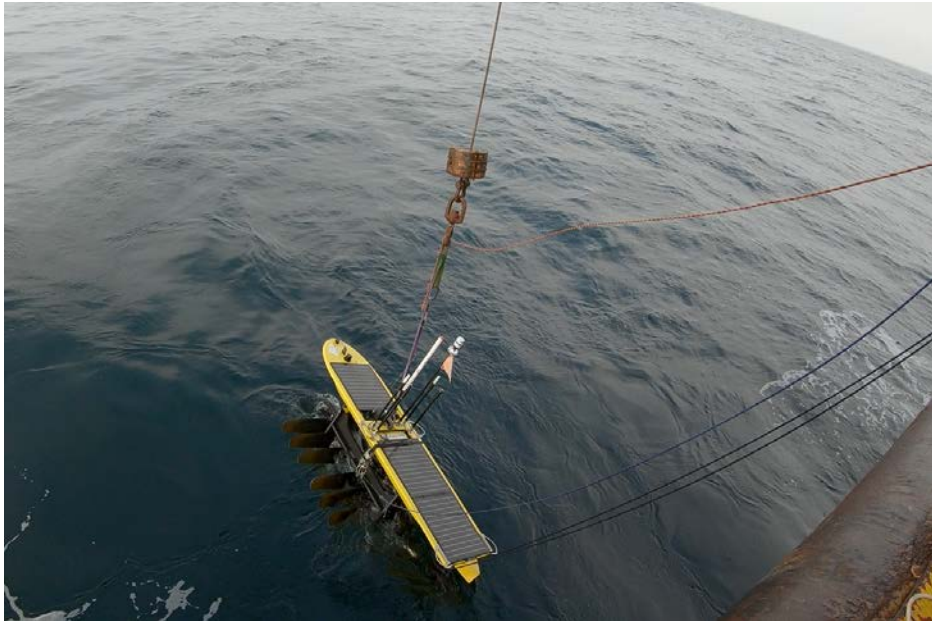

Fig. 4.2 Waveglider deployment

The waveglider was recovered at waypoint 251 on the 27th June 2018, at 16:00 UTC (50° 22.754N, 07° 42.822W). The weather conditions were good with a wind of 12 knots @ 090°.

During the recovery the Waveglider was brought into position using the MOB workboat. The glider was held against the side of the MOB boat and towed into position. This approach caused considerable difficulties as the Waveglider was continually pulled underwater. Once in position the float unit hooked onto the starboard hi-ab crane. The float was hauled to bulwark level and a messenger drop weight was used to attach to the sub unit whilst it was still underwater. The sub unit was hauled on-board using the starboard p-frame Rexroth winch and then the float unit was recovered to the deck. This was possible in the benign conditions seen during the cruise, but would be more challenging and dangerous in bigger seas (Fig. 4.3).



Fig 4.3 Waveglider recovery

1.27. Waveglider Mission 2

The Liquid Robotics (LRi) SV3 Waveglider 026 'Waimea' was deployed for a one day acoustic trials mission to test the range and performance of the Sonardyne Acoustic Modem installed in the waveglider. The range was tested by attaching a Sonardyne's AvTrak acoustic beacon to the Isis ROV, and sending test data to it from the acoustic Modem in the Waveglider. These tests were undertaken as the ROV descended to a depth of 4000m, and continued as the waveglider was commanded away from the ROV until the communication link started to fail.

1.27.1. Waveglider Payload:

- RDI 600kHz ADCP s/n 19375
- Airmar weather station s/n 2922486
- Airmar water speed sensor s/n 2598788
- Sonardyne 9522B acoustic modem s/n 288-081-001

1.27.2. Isis ROV Payload:

Sonardyne's High Power AvTrak Beacon ID 4907 was attached to the ROV (see photo Fig. 4.4); serial communications to the surface were via the umbilical.

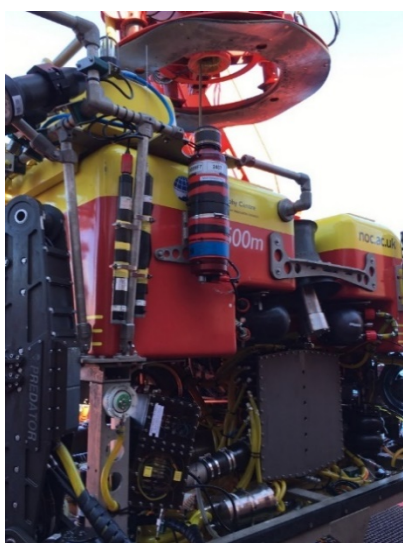

Fig. 4.4 Sonardyne AvTrak Beacon installed on the Isis ROV

1.27.3. Deployment Description

The Waveglider was deployed at Whittard Canyon (station 46) on the 3rd July 2018 at 06:53 UTC, 47° 46.317N, 10° 08.671W. The water depth was 4156m and the weather conditions were excellent (Fig. 4.5), wind 8 knots @ 310°, sea state 1 – see image below.



Fig. 4.5 Waveglider Mission 2 deployment and test conditions

The Waveglider was deployed in the same manner as that of mission 1. But to overcome the issue seen in the first deployment the GPCTD and pod were removed thereby allowing the quick-release ratchet strap to be positioned further forward.

Once the Waveglider had been successfully launched it was directed into a holding pattern of six waypoints (11-16) spaced 250m from a central point (waypoint 67). The ROV was launched and once communication had been established between the Waveglider and the ROV, the Waveglider was sent East to new location and directed into a holding pattern (Fig. 4.6) of four waypoints (18-20) spaced 50m from a central point (waypoint 17). The track was offset by about 650m from the ROV to minimise any possible interference between the ship and the waveglider. The waveglider continued to circle as the ROV descended to the sea floor at a depth of 3870m. When the ROV had reached the seabed the Waveglider was sent on a transit taking it away from the ROV, and messages sent until the communication link started to fail.

A script provided by Sonardyne Ltd contained the message data that was transmitted between the Waveglider and ROV, on receipt of commands sent from the WGMS interface on the James Cook. Data quality measurements were carried out as the ROV descended from 500m to the seabed (3870m), and data quality statistics were returned to the Waveglider every few minutes. A summary of the data was returned to the testers via the Waveglider WGMS interface; the full set of returned data was stored on the Waveglider and subsequently removed after the Waveglider had been recovered to deck.

Once the acoustic testing was complete the Waveglider was sent North overnight until recovery at waypoint 48. The Waveglider was recovered in Whittard Canyon on the 4th July 2018 at 05:46 UTC (47° 58.965N, 10° 11.357W). The weather conditions were excellent; sea state 1, wind 13 knots @ 315°. The recovery was slightly modified from Mission 1 due to the difficulty in towing the Waveglider alongside the MOB boat. For Mission 2 the Waveglider was towed ~4m behind the MOB boat from

two bow lines for recovery. In this way the boat was able to manoeuvre more easily, and proved an effective method of towing the waveglider.

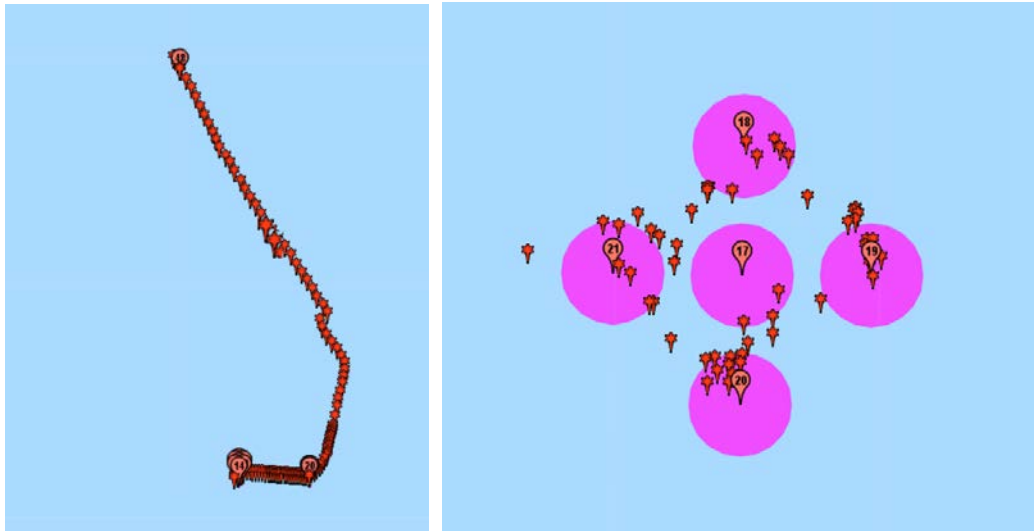

Fig. 4.6 Waveglider holding pattern on 50m radius (using PID line-following)

1.27.4. Acoustic Testing Results

The tests showed that at a bit rate of 900 bits/second, the AvTrak would communicate dependably to the Waveglider down to 3870 meters; further analysis by Sonardyne extrapolates satisfactory communication for a further 1500 meter depth. At a bit rate of 3500 bits/second, the AvTrak lost dependable communications at about 1500m. However, increasing the range setting for the transmitting signal should provide increased signal power and may have allowed a higher bit rate for a greater range.

The AvTrak continued to communicate reliably at 900 bits/second while the ROV was holding at a depth of 3870 meters and the waveglider moved away. At a horizontal range of 1500 m from the ROV the communication link failed. This equated to a slant range of approximately 4700 meters. Reducing the bit rate to 200 bits/second did not significantly increase range. It is possible that this link failure was the result of the heading of the ROV shielding the AvTrak from the Waveglider, however this was not tested during the mission.

The testing also showed that turning on the Waveglider's thruster caused a significant deterioration in signal quality, due to the higher background noise seen by the acoustic modem. Thus, it is not recommended to run the thruster while attempting to use long range acoustic coms.

Periodic analyses of the acoustic noise spectrum were taken from the AvTrak at various depths as the ROV descended. The noise spectrum did not change appreciably with depth. The results were taken with the hydraulics powered off, and with the thrusters running at about 80% of full power. The graph below (Fig. 4.7) shows the ROV noise spectrum at 3870 meters.

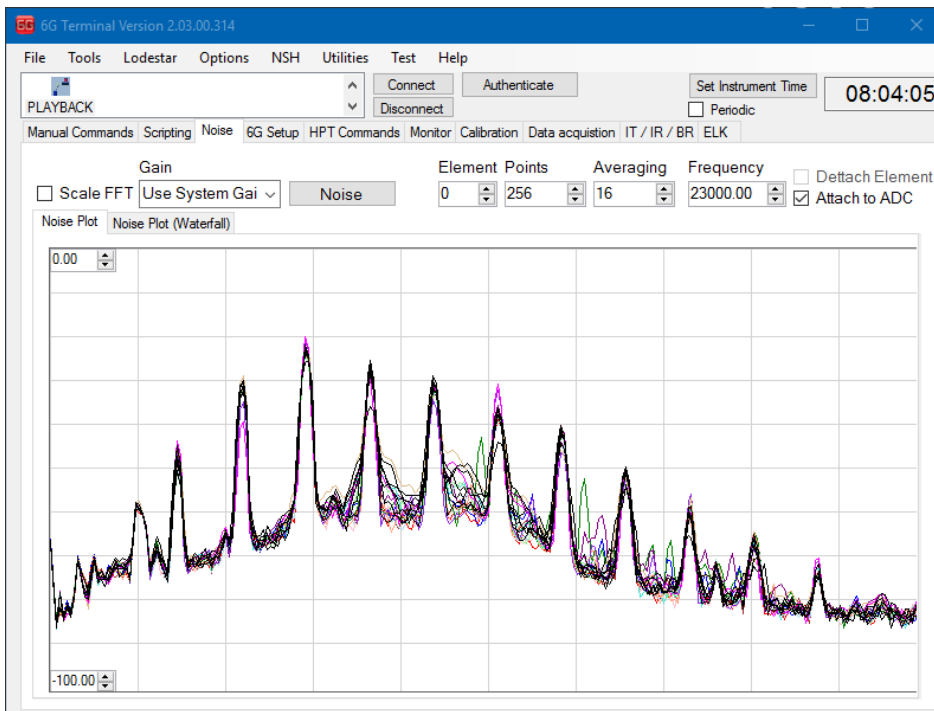

Fig. 4.7 Noise spectrum for the Isis ROV with the hydraulics off, and thrusters at 80% power

The graph below (Fig. 4.8) shows the noise spectrum of the Waveglider, showing noises sources from the thruster and rudder.

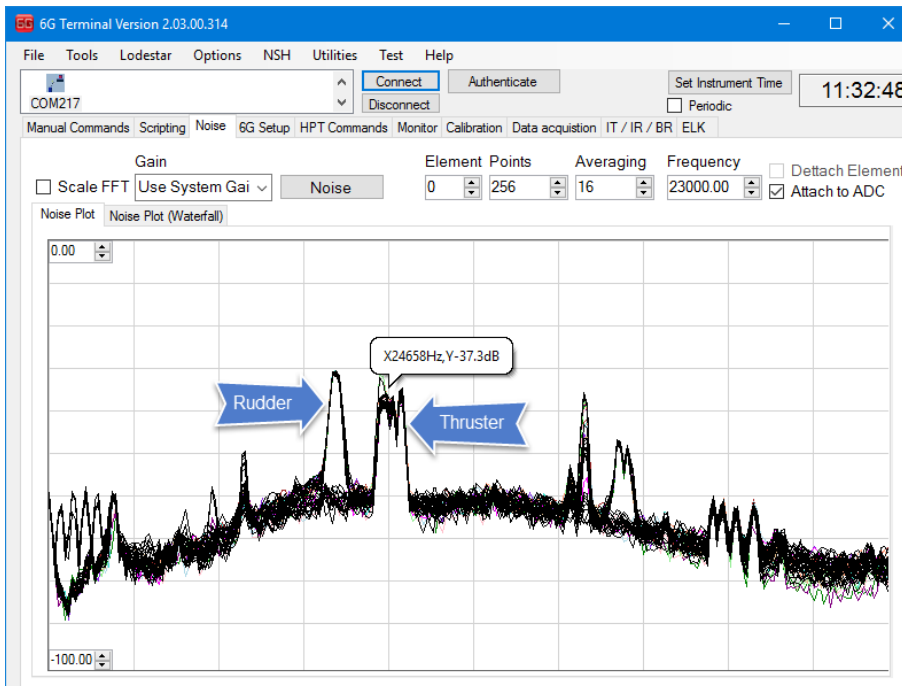

Fig. 4.8 Noise spectrum for the Waveglider Waimea with the rudder and thruster signatures highlighted

Overall, this testing allows us to conclude that the Sonardyne acoustic modem installed on the Waveglider will communicate to a subsurface beacon to a depth of at least 4000m at 900 bits per second, with some margin still available.

1.28. Faults, technical notes and recommendations:

- a. Prior to mission 1, a fault was found in the umbilical cable. Wear in several places had exposed the outer sheath, and a corroded pin was found on the float subconn connector. The sub unit and umbilical were swapped, and functioned as normal for both missions.
- b. Prior to mission 1 the Airmar weather station was not producing any output. After swapping the weather station the problem persisted. A console script command issued prior to the last deployment by LRI pilots was found on the WGMS command history: %airmarWeather.pilotRequest(1). This command appears to be an alternative method for powering on the weather station. Subsequently the weather station reported GPS positions correctly and did output most parameters, but the temperature output remained as 'NaN'. This issue requires further investigation.
- c. Deployment on mission 1 was made difficult by the lack of strengthening bracket on the 'pod' housing the GPCTD sensor underneath the sub unit. This forced the quick-release ratchet strap to be fastened near the rear of the vehicle, and led to the two parts working free before reaching the water. Deployment was still successful, but could have been difficult in rough weather. For mission 2 the GPCTD and pod were removed, allowing the quick-release ratchet strap to be positioned further forward.
- d. Recovery on mission 1 was difficult due to the inability of the MOB boat to tow the vehicle alongside without the vehicle pulling underwater. For mission 2 the Waveglider was towed ~4m behind the MOB boat from two bow lines for recovery. In this way the boat was able to manoeuvre more easily. This will be recommended in future where a jet boat is to be used.

Deep glider Report

Ship Based Operational Team : Steve Woodward, Mike Smart

Shore side Operational Team : Dave White

1.29. Objectives

The aims of the Deepglider mission from the trials cruise were:

1. Ocean test of the glider to as deep as possible
2. Endurance of greater than a day to allow power consumption to be judged
3. Demonstration of function

1.30. Deepglider Configuration

University of Washington developed Deepglider 042 'Darth' (6000m rated)

1.30.1. Payload:

- Seabird free-flow CT s/n 292
- Aanderaa 4831 oxygen optode s/n 453
- WetLabs fluorometer (Chl/CDOM/700nm backscatter) s/n 4746

1.31. Deepglider Mission Summary

The Deepglider was launched on 23rd June and recovered on 3rd July, a total of 10 days. During that time it completed 40 dives, with 8 dives deeper than 1000m and 5 dives deeper than 4000m. The deepglider initially headed south into deep water at the mouth of Whittard Canyon, then east before returning north for recovery (Fig. 5.1). The maximum depth achieved = 4336m (dive 24), and a total of 4 consecutive dives to 1000m were made to assess its comparability to the Seaglider (Kongsberg M1).

Because this was a trial, and necessarily short, trimming and adjusting for long endurance was not fully implemented.

1.31.1. Deployment and Recovery Details

Deployed	Whittard Canyon (Station 11), 23 rd June 2018, 15:21 UTC, 47° 53.089N, 10° 10.763W, water depth 4040m. Conditions were excellent, wind 13 knots @ 070°.
Recovered	Whittard Canyon, 3 rd July 2018, 05:41 UTC 47° 48.547N, 10° 09.802 W. Conditions were excellent, wind 8 knots @ 310°.

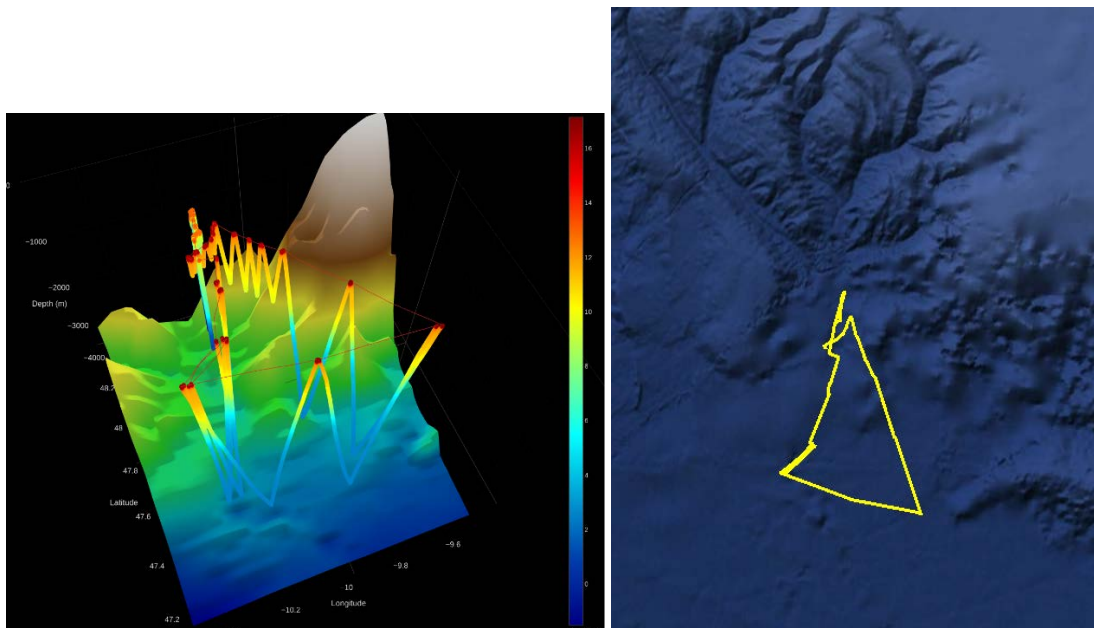

Fig. 5.1 Glider deployment track and temperature with overlaid bathymetry

1.32. Deepglider Launch and Recovery

The deepglider was launched using the starboard quarter crane (Fig. 5.2). The deployment used a rigid rope rig to prevent damage to the antenna, and a pole was used to fend the glider away from the ship. The recovery used an aluminium recovery hoop on a 10m carbon fibre telescopic pole (Fig. 5.3). The glider was hooked by the starboard waist and hauled on-board using the starboard p-frame Rexroth winch.

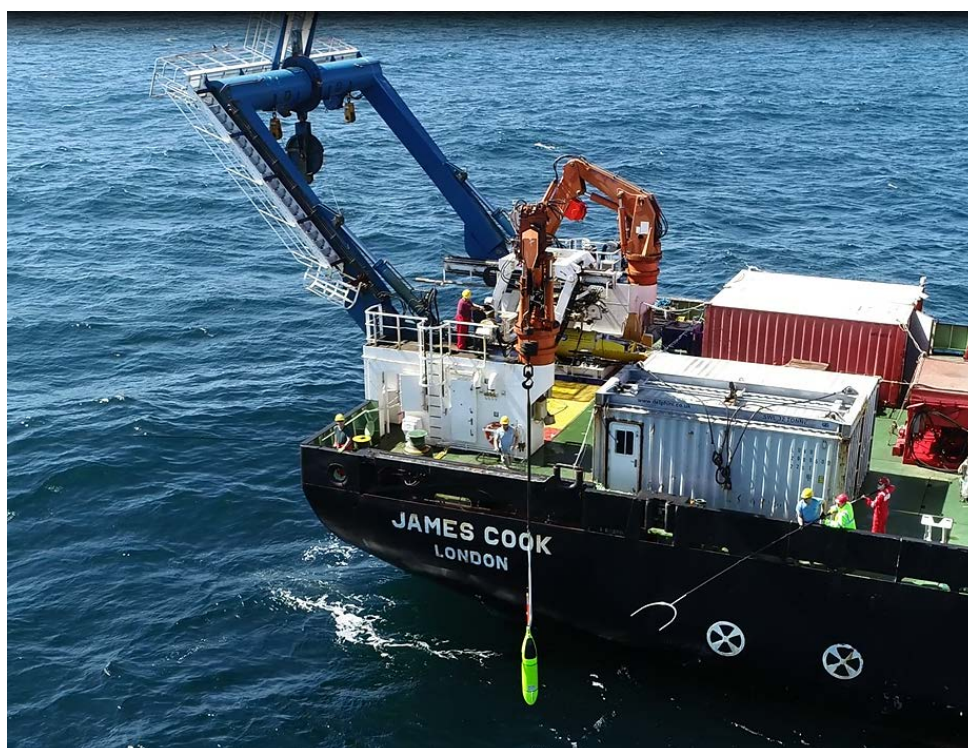

Fig. 5.2 Deepglider deployment

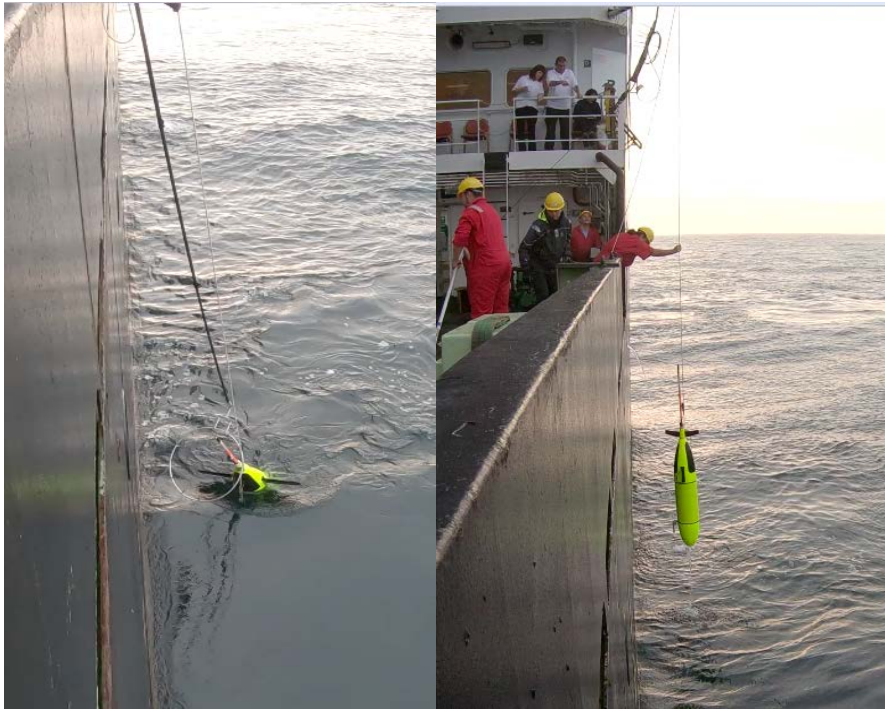

Fig. 5.3 Deepglider Recovery

1.33. Regression

Once trimmed to fly predictably, the key to both Seaglider and Deepglider efficiency is to run regressions on the dive data, and modify the on-board flight models. This also helps produce valid data: the salinity is measured using a long thin conductivity cell, and the flow through that is predicted from the glider's angle of attack and slip, derived from the on-board flight model. Getting this model to reflect reality as closely as possible is essential.

The glider is set to run a series of dives at different angles and speeds, and these are run through a series of regression programs. It has been found by UW that diving to 100m-200m gives a good set of figures, which enables a set of 4 or 6 regression dives to be completed by the pilot without unnecessary hardship. Nevertheless, it still takes a day out of the schedule.

One set of dives were run, dives 11-14, to 150m. The new values of A and B, the critical drag coefficients were calculated, and implemented from dive #17 onwards.

1.34. Issues

1.34.1. Altimeter

After the second deep dive, the glider struck the sea bed. After some investigation, it appears that the altimeter developed a fault. Checks in the lab showed that it pings, and passes self-tests. Advice from UW is that it is probably a hardware fault. Further investigation will be undertaken.

1.34.2. Antenna angle

Advice from UW is that the Deepglider usually exhibits a poorer antenna angle than the Seaglider. This is an issue with this type of design, which needs the antenna out of the water in order to use Iridium. A Seaglider typically uses 60-70 degrees, the Deepglider was between 25 and 40 degrees.

The glider firmware returns an angle for the antenna at the time of GPS2, the GPS fix prior to diving. This will be a snapshot, and is quite variable. Observations from the ship suggest that the glider comes

much more upright when in the act of diving, i.e. bleeding oil from the bladder, so attempts to improve antenna angle revolved around reducing SM_CC, the amount of oil pumped into the bladder at the surface. The mechanism causing the reduced angle is thought to be twofold: thermal expansion of the compresses at the surface, producing a distributed increase in buoyancy in the glider, moving the centre of buoyancy forward. The optode is also mast mounted, and out of the water, putting additional weight aft.

Plotting antenna angle vs. SM_CC is not conclusive, see Fig. 5.4 below. There were two main values used, 415 and 425. 405 and 400 were also tried but the initial angle was not noticeably different. 440 was used for 2 dives and did not produce as good an angle as any when using 415. Overall, 415 produced a better antenna angle than 425, but the way it increased over time suggests that there is an underlying factor at work as well, or even instead. There was no great difference between deep and shallower dives, so sea surface temperature or even sunlight may be the factor.

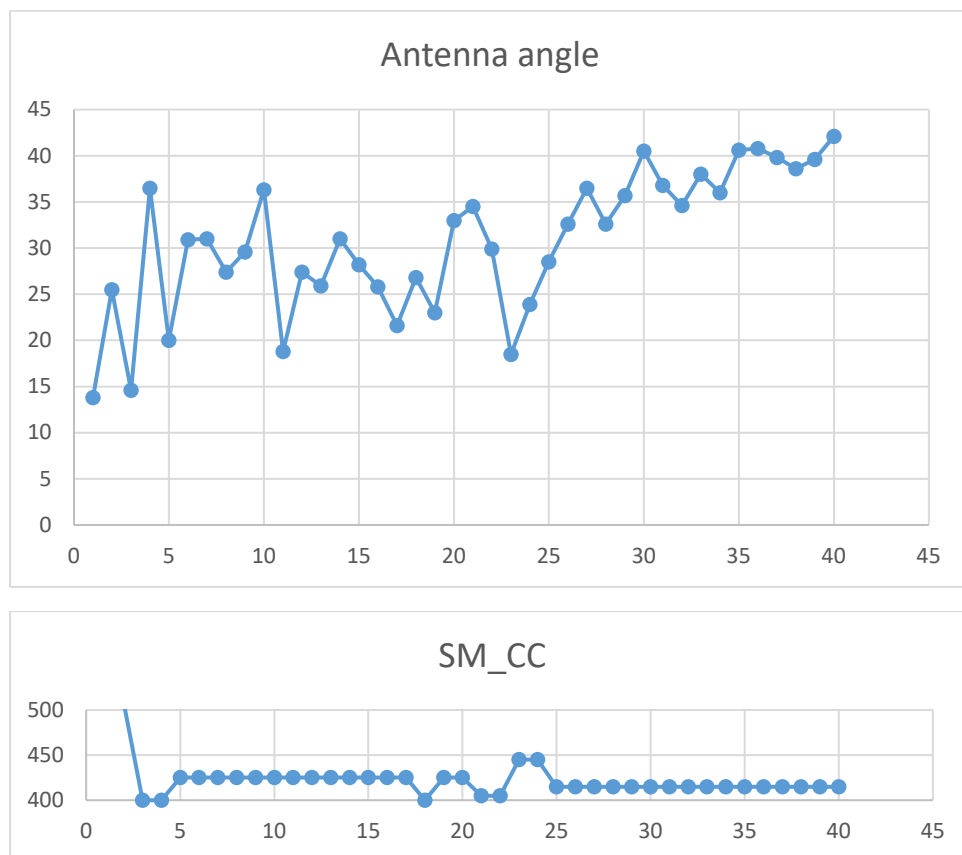

Fig. 5.4 Antenna angle and oil volume pumped in bladder at the surface

In conclusion, an SM_CC of 415 works well. Lower values may improve matters, but may not. Higher values do not make the angle any better.

Although buoyancy and temperature effects seem to predominate, the position of the optode on the antenna is a significant factor. The above trials took place entirely during a period of calm weather and low swell heights.

1.34.3. Sensor noise

On the first few dives, the science file was set to sample:

```
//depth time sample gcint profile
100 seconds=10 sensors=111 gc=30 profiles=333
500 seconds=10 sensors=222 gc=60 profiles=333
1000 seconds=10 sensors=333 gc=120 profiles=333
```

There was a significant amount of noise, or jitter in the CT data below 100m which increased below 500m. On advice from UW, the sensors field was kept at 111 and the timing set to seconds=20 and 30 which removed the noise entirely. It is surmised that using a multiplier in all 3 fields is asking the processor to do too much, and errors in sensor timing resulted. Further trials with different multipliers would be useful to bottom out the limitations of the processor.

1.35. Power consumption

The projected power consumption was analysed based on the 40 dives undertaken. The broad conclusion is that the Deepglider could probably be used to replace a Seaglider in water depths greater than 100m.

The overall consumption was greater than expected, but max_buoy was kept consistently high: the need for forward progress to be made outweighed other factors. Using max_buoy = 250-300cc the glider was traveling at 0.2m/s over the ground, calculated at 30-40cm/s horizontally through the water and measured at just over 0.1m/s vertically. This is significantly faster than usual and by reducing this the glider's endurance should increase.

Based on the measured figures, the primary pack would probably last for at least 145 days (116 days to 80%). Power consumption varied from just under 2Ah/day at 500m to 1Ah/day between 1000m and 4000m.

1.36. Conclusions

The deepglider was effectively launched and recovered from the ship using the standard 'seaglider' techniques. The recovery was made considerably easier by the positioning of the CT sail forward.

Without doubt, the glider operates at its best when diving to depths of greater than 3000m and running legs of many 10's of kilometres. Diving to 4000m, the glider was covering 15km+ per dive, and taking almost a day to do so. Slowing the glider down to improve endurance will increase this up to 36-48 hours, going by UW's experiences.

Operating off the shelf, in 1000m or so is not much less efficient, and is comparable to a Seaglider diving to 1000m. Operating in 200m or less is highly inefficient, maybe even more so than for the Seaglider.

C-Worker 4 Report

Operational Team : Owain Shepherd, Mike Smart, Phil Bagley

1.37. Objectives

- **Determine the best approach for launch and recovery from a ship**

The C-Worker 4 was designed to operate in in-shore waters supported from the Quayside or a small support vessel. For Autosub6000 operations we wish to use the C-Worker 4 to follow the Autosub6000 on the surface and relay positional and other data from the Autosub6000 to the mother ship. This would allow the mother ship to perform other tasks whilst keeping in communication with the Autosub6000 (via the C-worker 4). This arrangement has the added advantage of allowing the C-Worker 4 to update the Autosub6000 position via GPS and USBL tracking to greatly improve Autosub6000 positional accuracy.

To operate the C-Worker 4 from a ship such as the *RRS James Cook* a number of operating procedures need to be developed to transition the C-Worker 4 from an in-shore autonomous vehicle to a vehicle capable of launch and recovery from a ship operating in the open sea.

- **Test the control range of the C-Worker 4**

During the C-Worker 4 sea acceptance phase issues were observed when attempting autonomous operations at range. Antenna height and radio interference play a part in limiting the available range. On the James Cook the antennas were placed on the Monkey Island above the bridge (some 20m above sea level) and thus a long range would be expected (greater than 10km).

- **Test the target tracking behaviour on the C-Worker 4**

To test the performance of the C-Worker 4 following a target.

1.38. C-Worker 4 Configuration & Control

The C-Worker 4 had recently been delivered for the trial from L3 ASV. It included a Sonardyne USBL beacon, forward camera systems, and a prototype launch and recovery lifting bridle for deployment from the *RRS James Cook*. The C-Worker 4 was lashed to the deck in the CAMEL transport trolley on the starboard side working area, as seen in the image below (Fig. 6.1).



Fig. 6.1 C-Worker 4 with its custom lifting bridle, and the CAMEL transport trolley strapped to the deck

The configuration of the boat during the cruise, coupled to the design of the C-Worker 4 lifting bridle meant that the launch had to be done using the amidships yellow HIAB crane, while the recovery was done initially using the P-Frame, and then transferring the vehicle back to the yellow HIAB. This was not ideal, but was the only feasible option given the constraints on the vessel.

1.38.1. C-Worker Control

Helm and Laptop for controlling the C-Worker were located on the Bridge (Fig. 6.2). This was necessary because the antennas for the C-Worker were fixed to the Monkey Island and there was a limited cable length between the antennas and the control box. Although this setup worked well once the C-Worker was underway as it gave both the ship's officers and the C-Worker 4 pilot a good view of operations it was very restrictive during the recovery phase (Fig. 6.3). The image below was taken by a camera from the Bridge, with the camera hard up against the window facing down. However, this would be an unnatural position for the helm operator and therefore once the C-Worker 4 was against the Fenders in the recovery position the helm operator could not see the C-Worker 4.



Fig. 6.2 C-Worker Control setup on the Bridge



Fig. 6.3 Restricted View of the C-Worker 4 during the recovery phase

1.39. Mission Summary

The C-Worker 4 had one trial deployment on the 29th June 2018. The conditions were unusually calm with very light winds.

1.39.1. The Launch Phase

Before the C-Worker 4 was lifted into the sea the recommended pre-launch check were carried out on deck. A water supply hose was attached to the engine water intake strainer and a second hose was directed at the Jet drive to cool and lubricate the system. Once the checks were successfully completed the water supply hoses were removed and all covers closed and latched ready for launch.

Steadying lines were attached to the Fore and Aft of the C-Worker, and the USV was attached to the hook of the yellow HIAB crane and lifted over the side (Fig. 6.4). Once in the water the engine was started (Pause mode) and basic helm checks were conducted (Fore, Aft, Port, and Starboard). The steadying lines were released and C-Worker 4 was driven away from the ship under helm control from the Bridge



Fig. 6.4 C-Worker 4 Launch. Tag lines still attached.

1.39.2. Comments & Recommendations

- The launch went very well and was easy under such good conditions
- The quick release jaw was not large enough to fit around the C-Worker 4 lifting strop. It should be possible to fit a thinner lifting point to make both launch and recovery easier.
- Despite best efforts to release the C-Worker 4 with its launch and recovery mechanism in the down position, The C-Worker 4 launch and recovery mechanism was released in its halfway up position resulting in the mechanism rapidly falling back down to rest on the cradle and the large foam bumper hitting the front payload hatch.
- Although in the benign conditions seen during launch there was time to start the engine and perform helm checks. In any bigger seas we would want to release the C-Worker 4 as soon as it was in the water to prevent damage. Whether there would be time for helm operations in a bigger sea is questionable.
-

1.40. C-Worker 4 Recovery

For the recovery phase a snap hook connected to a 10m extendable recovery pole was configured with a recovery line. This line was connected to a strop which was connected to the P Frame winch cable and fed over the P frame block. The yellow HIAB crane was positioned just outboard to prepare for the transfer of the C-Worker 4. A cargo net with 4 fenders attached was lowered over the side to protect the C-Worker from impacts against the side of the ship during the recovery phase.

The C-Worker 4 then approached from the Starboard side and was driven against the fenders to hold position. The *RRS James Cook* was steaming at 4 knots ahead with wind on the Port forward quarter to develop a lee on the starboard side for recovery. This approach mimicked the typical pilot boat transfer procedure.

The snap hook was then attached to the C-Worker 4 lifting strop, and the USV was lifted using the P-Frame while being held against the fenders on the side of the ship (Fig. 6.5). Once the C-Worker was raised sufficiently the weight was transferred to the yellow HIAB crane and the vehicle was swung out away from the ship, and then brought back on board and landed on the deck.



Fig. 6.5 C-Worker 4 recovery. Just after the transfer from the P-Frame to the Yellow HIAB

1.40.1. Comments and Recommendations

- Steaming the James Cook ahead at 4 knots appeared to be about the right speed. At that speed the C-Worker 4 was very responsive.
- Due to restrictions in the length of helm cabling, the C-Worker 4 was controlled from the Starboard side of the Bridge. However, when the P Frame was outboard for recovery there was very restricted view of the recovery area. Once the C-Worker 4 was against the Fenders the Helm could not see the C-Worker at all and commands were relayed over radio from the deck. A remote helm (WiFi connected) or long wired connection is required for recovery in heavier weather.
- Steadying lines were snap hooked into the aft jet guard. However, there was no ideal location to snap hook into at the bow. A stainless steel snap hook ring on the bow would be preferred.
- During recovery it was difficult to snap hook into the C-Worker 4 recovery strop. It took 5 attempts. In the benign conditions experienced during the recovery we had the time to do this however, in heavier seas this extra time would have increased the risk of damage to the C-Worker 4. The C-Worker 4 strop was thick and we only had a medium size snap hook available. A smaller diameter hard recovery loop and larger snap hook would have made this process easier.
- The large foam block on the C-Worker 4 launch and recovery system restricted forward facing camera view. Something better need to be developed. There is a metal catch / rest frame

which should prevent the launch and recovery system from damaging the C-Worker 4 when released.

1.41. Range Test

For the Range test the C-Worker 4 was placed into hover mode (with a supervision timeout orbit). Then the *RRS James Cook* steamed away at a speed of 4 knots to determine what control range was achievable. The ship was moved so that an unshaded and direct path between the antennas on the monkey island and the C-Worker 4. Unfortunately, the C-Worker 4 dropped into Estop after only 4.5km. The Cobham radio was still working well with only 10% packet loss at this range.

The C-Worker 4 requires a UHF “heartbeat” signal at regular intervals from the control station. If the heartbeat signal is not received the C-Worker 4 drops out of autonomous control and drifts. Therefore, there was an issue with the UHF heartbeat to the C-Worker 4.

On losing UHF heartbeat the ship turned around and steamed back towards the C-Worker 4. In this orientation the antennas on the monkey island were shaded by the ships infrastructure. However, at a range of 4km full communication was re-establish with the C-Worker 4. The C Worker 4 had drifted 700m from its hover position in this time, and had not dropped into supervisory timeout mode (orbit). During the remaining transit back towards the C-Worker 4, full communication and control was maintained.

1.41.1. Range Test Comments and Recommendations

The loss of the UHF “heartbeat” signal between the C-worker 4 and the control station has been an on-going issue during acceptance testing. This issue is being investigated by L3 ASV to resolve the issue.

1.42. Target Tracking

To mimic the C-Worker 4 following the Autosub, a follow target autonomous operation test was performed. The cruise schedule precluded the use of the payload Sonardyne USBL system tracking a subsurface beacon. Therefore, to test the follow target behaviour the C-Worker 4 was setup to follow the *RRS James Cook* AIS beacon.

A lateral offset of 70m was set to place the C-Worker 4 70m to starboard in line with the Bridge. The intention was to manoeuvre the James Cook to assess the response of the CW4 to directional changes.

Initially, the virtual target appeared in the correct position 70m to starboard. The C-Worker 4 moved towards the virtual target but overshoot and paused when it entered the follow target exclusion zone near the virtual target. As we then moved off at 4 knots, the virtual target kept falling incrementally astern, therefore the CW4 spent most of its time not following but waiting to move outside the follow target exclusion zone. At the end of the test the virtual target was 200m astern of the required position (70m to the starboard side of the *RRS James Cook*) and so the follow target test was abandoned.

1.42.1. Follow Target Comment & Recommendations

The follow target autonomous behaviour is a critical function for this vehicle. It is expected that the failure in this test was either a configuration or software error. This issue is being investigated by L3 ASV so that the issue can be resolved.

ALR1500 Echosounder

Operational Team : Richard Morrison

1.43. Overview

JC166/167 was a joint cruise, combining science missions with MARS trials and training. The cruise departed from NOC, Southampton on the 19th of June, and arrived back to NOC, Southampton on the 6th of July.

The cruise explored areas Haig Fras and Whittard Canyon in the Celtic Sea.

Whittard Canyon's deep waters were used as a test bed for the ALR echo sounder system. The goal of testing the echo sounder was to evaluate the design against the requirements, as well as recording the received data. The received data would then be used to write and program an algorithm for the system to detect the depth of the sea floor below the echo sounder.

The target vehicle for the system is the ALR 1500 AUVs. These vehicles are capable of depths down to 1500 m on missions lasting several months.

1.44. Methodology

The system requirements specify a depth range of 150 m to 4000 m. The least depth-rated part of the system is the transducer, which is capable of withstanding depths of 1800 m. The depth rating of the AUV is 1500 m, therefore testing will be down to 1500 m. It was also desired to test the effects of Doppler shift on the results, with the target vehicle expected to move at speeds of 0.5 m/s.

Taking these testing requirements, a test plan was devised. The system was tested at 3 sites, with depths of 1600 m, 3000 m, and 4200 m. The system was lowered and raised at a rate of 30 meters/min or 0.5 m/s. The system was stopped at depth stops of 50 m, 200 m, 500 m, 1000 m, and 1500 m, to gather data without Doppler shift interfering with the results.

As the tests require at least 1600 m of water, all were done at Whittard Canyon, as the Haig Fras site did not have any water deep enough.

1.45. Results

Test 1 – 4000 m – 24/06/2018

A test site with a depth of 3975 m was chosen in Whittard Canyon. The results from the test showed the system had rebooted about 20 times. No data was recorded, but several empty files were left where the system had crashed between opening the files and saving the data.

Test 2 – 20 m – 25/06/2018

Initial testing showed the system working on deck, using both the external power supply and the battery. The system was lowered into the water to a depth of 20 m with the same results as the first test. There were several empty files as symptoms of a crash occurring somewhere in the main loop.

Test 3 – 10 m – 25/06/2018

With some potential test fixes applied, the system was deployed to a depth of 10m. The system was able to open a file and write data without crashing, showing the problems from the first two tests had been solved. However, the system was not recording any of the data received from the transducer.

Test 4 – 90 m – 27/06/2018

The sphere was opened, and the electronics from the inside were swapped for the spare. The system was deployed in 100 m of water, at depths of 50 m, 75 m, and 90 m. The system was towed at <1 knot for a short period near the end of the test.

The resulting data showed strong returns received, as well as echoes from the surface.

Test 5 – 1600 m – 01/07/2018

The system was successfully deployed in 1600 m of water, following the test plan. The results were as expected. The system showed no signs of problems during the test.

Test 5 – 3100 m – 01/07/2018

As the weather was too rough to deploy the ROV, a second echo sounder test was done. The system was deployed in 3100 m of water, following the test plan.

Once reaching about 1400 m, the system rebooted once. It was able to take two more measurements before crashing permanently. The data recorded by the system while working was as expected, showing a returned signal from the sea bed.

Test 6 – 4200 m – 03/07/2018

The echo sounder was deployed in 4200 m of water, following the test plan. Upon recovery, there was no data on the storage. The system had failed to start up and hadn't recorded any data from the test.

1.46. Software Fix Summary

During testing on shore, a problem was observed with the serial line when connected to the test harness. This problem was not evident while testing the electronics in the lab, and only manifested once the system was installed into the sphere, and connected to the battery. Using the shore power debug lead would not cause the fault. The fix applied at shore was to ensure the system would not transmit any data over serial before first receiving a byte.

When the system first showed signs of rebooting at depth, a harsher fix was applied, completely disabling the serial peripheral in the software, with a secondary build of the software for deck testing, data download and system debug. This fix, combined with cleaning and re-greasing the connectors allowed the system to work in the sphere while submerged. Hardware Fix Summary

No fixes were made to the hardware, besides swapping the electronics for the spare.

1.47. Conclusions

The two main goals for these tests were to test the system was working at maximum effectiveness, and to gather data to write a depth detecting algorithm.

The data gathered from these trials will be useful for writing the depth detection algorithm, with a simple algorithm in MATLAB being able to detect the depth from 100 m to 3050 m.

The system was tested with a maximum distance of 3000 m, which is 1000 m short of the 4000 m target. The system showed a 0 dB SNR at this range, which suggests the 4000 m range will not work without changes.

The noise floor from the detected data was given by ADC quantisation noise, and not the background noise of the sea. This indicates that applying an analog gain to the system before the ADC may increase the SNR. Calculations suggest the SNR may get up to 20 dB at 4000 m, giving a high probability of detection over the range of the system.

An effect was observed when the ADC saturates due to the outgoing ping, the incoming data is offset, slowly drifting back to zero. This was solved in MATLAB using a high pass filter.

The current sense amplifiers did not function, although they were boded on to the board at the last minute, so perhaps not unexpected. The voltage across the capacitor is measured at a regular interval so the total power put into the transducer was measured to be about equal to what was measured with dummy loads, and in the acoustic tank.

Although the system performed worse than expected, it is reasonable to believe the performance of the system could be improved with minimal adjustments. The ADC on the system contains an amplifier which can be used to apply the 20 dB gain.

The next opportunity for testing the system will be on the ALR long distance trials, where it will be expected to be working. Fortunately, the data from JC166/167 will be enough to write an algorithm to detect the depth. By recording the data recovered from the long distance trials, the system's performance can be re-analysed with a (hopefully) higher SNR.

Drone

Operational Team: Terry Wood, Richard Morrison and Naomi Gold

1.48. Objectives

The objectives for the drone trials during the cruise were:

- To test the practicality of using a quadcopter drone while at sea and to explore where and how the drone could be launch and recovered on the ship
- To produce video recordings of the launch and recovery of MARS assets as future training aids, and for coms purposes.

1.49. Configuration

The drone used was a DJI Phantom 4 Pro+. Two spare batteries were taken to maximise the flight time. The quadcopter, its controller and carry case are shown in the image below (Fig. 8.1). The drone itself has a ~30 minute flight time, a gimbal stabilised 20 MP camera, and can film in 4k. The vehicle also has obstacle avoidance capabilities and return to base functionality.



Fig. 8.1 Phantom 4 Pro+ drone used during JC166-167

1.50. Operational Summary

The drone was primary hand launched and recovered, due to the steel deck affecting the automatic drone calibration procedure, and the hand launch offering more control on a moving deck. The testing was initially done on the foredeck of the ship as this was relatively clear of infrastructure and would not get in the way of operations. An example image of this testing is shown below (Fig. 8.2).



Fig. 8.2 Example image from the drone while testing on the foredeck

Once the initial testing had been completed and the team had confidence in operating the drone from the ship. The drone was also launched from the starboard deck amidship to film the launch of the deepglider. This used the hand-launch and catch technique practised on the foredeck, and proved to be highly successful. The drone was driven up and out from the starboard side to miss the ships infrastructure, as shown in the following image (Fig. 8.3).



Fig. 8.3 Launching the drone from the starboard side

Once clear of the ship the drone was manoeuvred into position to record the launch of the deepglider (see following image, Fig. 8.4), and track the launch, setup and dive of the deepglider. Once the filming was finished the drone was brought back to the starboard deck and caught as part of the landing.



Fig. 8.4 Drone recorded launch of the Deepglider

The drone was also launched and recovered from the rear quarter of the ship near the rear deck crane pedestals. This worked well as the drone could quickly move away from the ships infrastructure.

1.51. Faults and Issues

- Experience from JC 166/167 shows that the vessel crew do not have a problem with drones being flown from the vessel
- The return to home (controller) did not function (reports of too few satellites)
- The drone gives over-cautious warnings of high winds
- Presumably because of the metal deck, the drone did not like taking off from the deck; it was better to launch by hand
- For unknown reasons, the drone would often give a warning that it had reached maximum altitude when in fact it was only at about 10 meters. Returning to base and re-starting would fix this problem
- There were occasions when the drone seemed to lose control.
- The drone does not hold as steady over water as well as it does over land.
- The starboard stern quarter of the vessel was a good location for drone launch to film operations
- On 23rd June 2018 the drone was lost at sea.

1.51.1. Loss of Drone

At approximately 8 pm on Saturday 23rd of June the drone was used to film some dolphins which were swimming close to the stern of the vessel. The drone was launched from the rear quarter of the vessel. It spent several minutes filming the dolphins over the stern, but as the lighting was poor it was used to film around the vessel as it was getting dusk. The drone had been up for approximately 10-15 minutes and was over the stern of the ship while the pilot was still at the rear quarter of the vessel. The drone then suffered a system failure and dived into the sea without warning. It could not be recovered.

Analysing the failure three possible failure mechanisms were considered:

- One of the blades broke during the flight. The blades are highly stressed and any weakness in the blade could cause it to have failed mid mission. This is considered to be the most likely cause.
- One of the blades was not correctly attached; this is possible although it seems that the flight had lasted too long for this to be likely.
- That the drone suffered a catastrophic internal systems failure. This is considered highly unlikely given the large number of drones on the market, and the extensive amount of testing.

1.52. Conclusions and Recommendations

Although the drone was lost during the early part of the cruise, prior to this it had produced very impressive films of the ship operations, and so is considered a valuable asset to take to sea. It was relatively simple to operate, and did not interfere with ship based operations.

1.52.1. Recommendations for future flights:

- Check blades for any damage prior to launch and replace all the blades after every second flight when the drone is going to be flown above water.
- Double check that the blades are correctly attach.

- Set the drone into a mode where the footage can be cached in the hand controller in the event of loss of the drone.

Acoustic processing

Operational team: James Strong & Catherine Wardell, with help from whole science party

1.53. Side Scan and Multibeam Sonar Collection

Autosub6000 Side Scan Sonar

Side scan data were collected by Autosub6000 over two missions (M142 and M143). Initial processing of the JSF formatted files using the SonarWiz software was associated with distinct artefacts in the data. As such, the JSF files were converted to XTF using Discover 4200-MP software (Edgetech). Note that some JSF files appeared 'corrupt' by blocks of zeros, and had to be 'repaired' using the EdgeTech-provided 'Repair tool'. The resulting XTF files were found to be free from artefacts. Side scan sonar data collected in Autosub6000 M143 lacked navigational data following the failure of the on-board data logger. The USBL track for that Autosub6000 mission was cleaned and inserted into the XTF files using NavInjectorPro (V6.01.013 - SonarWiz).

All side scan sonar XTF files were processed in SonarWiz (v7). Each line of data was bottom-tracked and underwent empirical gain normalisation. The amount of overlap between lines was minimised to reduce averaging artefacts (fuzzy areas between lines). All individual lines were exported from SonarWiz as rasters (Erdas Imagine format). Rasters were imported into ArcMap. Side scan sonar sections forming a single line within a station were mosaicked together, generating single rasters for each complete line across a station. Drift in the Doppler-based Autosub6000 navigation meant that offsets were apparent when lines were aligning together. Consequently, all full-length lines were georeferenced in ArcMap to produce a complete, internally consistent raster. The final site rasters (Fig. 9.1) were subsequently georeferenced to a SSS raster produced in 2015.

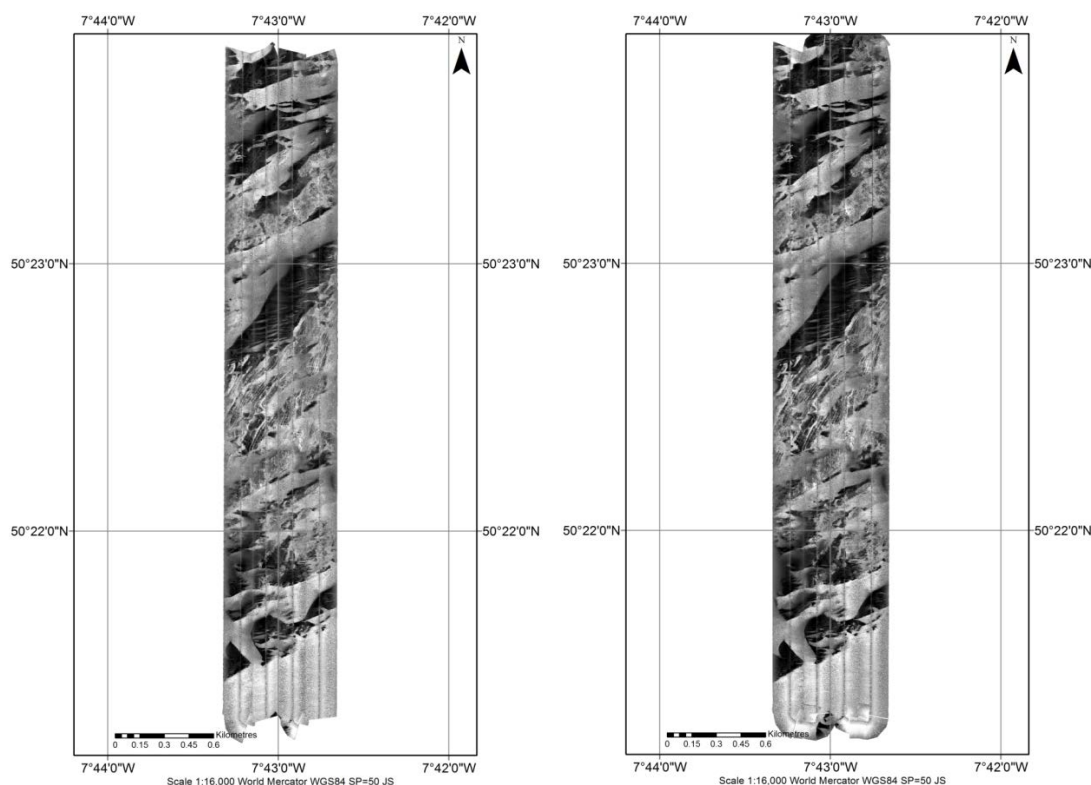

Figures 9.1a and 1b. Side scan sonar imagery for Haig Fras collected by Autosub during M143, before (left) and after (right) the night-time photography.

Autosub6000 M142 collected both high and low frequency side scan sonar. To obtain the clearest image of the potential mini-mounds, a raster combining both data types was produced. The central section (running along the nadir) of the high frequency image was superimposed over the low frequency image. This process provided a final image combining the extensive coverage of the low frequency imaging with the high level of detail captured by the high frequency system along the nadir (Fig. 9.2).

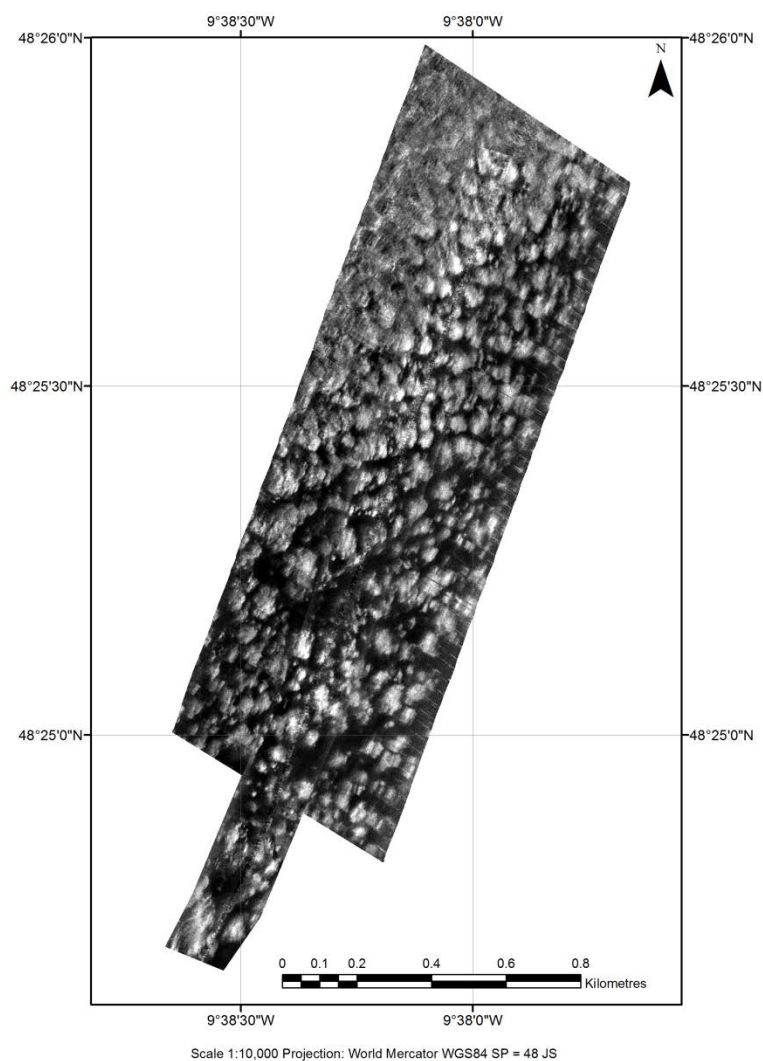

Figure 9.2. Side scan sonar composite (high and low frequency imagery) of an inter-flume area near Whittard Canyon. Collection by Autosub 6000 on JC166.

Autosub6000 EM2040 Multibeam Echosounder

Multibeam echosounder data from Autosub6000 were initially processed with CARIS, but errors remained (significant across-track striping). Processing with Caraiibes did not solve the problem, hence post-cruise data analysis will be needed.

RRS James Cook Multibeam Echosounder

Multibeam echosounder data were collected at both Haig Fras and around Whittard Canyon to extend the existing data coverages. The shipboard Simrad EM710 sonar was used for water depths less than 800 m whilst the shipboard Simrad EM122 sonar was used for deep-water (>800m) bathymetric data collection. Data from both sonars were acquired using the Seafloor Information System (SIS, Kongsberg) and processed using CARIS HIPS and SIPS (v9.1.8). Sound Velocity profiles were collected at both survey sites with a Valeport MIDAS sound velocity profiler. Data were collected throughout transits at ~10kts whilst survey lines were run at ~8kts. The beam angle was set at 65 degrees for both systems with equidistant spacing, swath width varying according to water depth.

The data were imported into CARIS HIPS & SIPS as .all files, using UTM zone 29 and a vessel file with the measured offsets for each sonar system. The navigation and attitude were checked and tides, created from POLPRED, applied. The data were merged and a BASE surface of 25m for Haig Fras, 25m for shallow water Whittard Canyon and 50m for deep water Whittard Canyon were created before the data were manually cleaned using both swath editor and subset editor. These surfaces were exported as ASCII.txt and imported to ArcGIS.

Backscatter

Backscatter data were collected using the shipboard Simrad EM122 and EM710 sonar systems using the Seafloor Information Systems (SIS, Kongsberg). The .all files were imported to Fledermaus Geocoder Toolbox ('FMGT') v 7.7.2, and processed using default settings. They were exported as GeoTiff files and added to the respective ArcGIS project.

ROV sample collection

Operational team: Dan Jones, Noelie Benoist, Declan Morrissey, Veerle Huvenne with help from whole science party

1.54. Aims

This work aimed to make collections of megafaunal specimens using the ISIS ROV. The specimens were required to identify organisms seen in video and still photographic surveys, to provide taxonomic specimens of common megafauna, to provide genetic material and to identify potential new species. In addition, samples of fossil coral skeleton were taken for isotopic dating and cores of sediment were obtained for assessment of the sediment type and composition.

1.55. Methods

The ROV ISIS collected specimens using four methods:

Suction sampler (either into suction sampler chambers, or deposited into containers on toolsled)

Push core

Direct manipulator collections

1.56. Results

A total of 65 specimens were obtained over six benthic sampling dives during the cruise. Specimens were collected from a range of habitats (rock and sediment) at 6 sites (2 Haig Fras sites and 4 sites in Whittard Canyon; Table 10.1). Video and still photographs of faunal collections provided clear *in situ* imagery that will facilitate evaluation of video transects (see below). Most of the taxa sampled on the seabed (Table 10.2) were successfully retrieved to the surface and preserved (Table 10.3). All biological specimens were preserved in ethanol so that they are suitable for taxonomic analysis and molecular analysis. To support a specific study (by colleague Dr C.R. Young) of the microbiome in the digestive system of holothurians, four specimens were dissected and specific components (tissue, gut content of anterior and posterior gut) were preserved either directly frozen at -80°C or in RNLater and then frozen at -80°C after 24h (see Table 10.3).

The geological and fossil coral specimens were collected, dried, labelled and bagged so they can be used for the intended studies.

Table 10.1: Specimen collection ROV dive details for JC166.

Site	Station		Date	Start Time	End Time	Depth meter
	No	Dive No		GMT	GMT	
Whittard Canyon	021	ISIS340	25/06/2018	13:10:00	19:35:00	355-372
Haig Fras	030	ISIS341	28/06/2018	16:54:00	21:29:00	81-99
Haig Fras	033	ISIS342	29/06/2018	14:55:00	19:24:00	71-86
Whittard Canyon	043	ISIS343	02/07/2018	09:42:00	15:46:00	440-619
Whittard Canyon	047	ISIS344	03/07/2018	09:52:00	19:24:00	3836-3841
Canyons MCZ	050	ISIS345	04/07/2018	12:27:00	16:55:00	903-1200

Table 10.2. Biological samples collected by ROV during JC166

Station number	Event	Event Type	GMT	Lat. Degrees	Latitude Minutes	Long. Degrees	Longitude Minutes	Depth (m)	Sample description	Location
21	3	TBE	15:23	48	16.85	-9	39.4	369	Coral fragment	In tube 10
21	4	SLP	15:46	48	16.84	-9	39.35	359	Sea cucumber (parastichopus)	White slurp
21	5	BIOB	16:31	48	16.81	-9	39.238	359	Cup coral, anemone 2x, yellow anemone	Forward biobox
21	8	TBE	17:05	48	16.784	-9	39.233	361	Coral fragments (3 scoops), squat lobster	Mid right, biotube 8
21	11	TBE	18:12	48	16.632	-9	39.101	361.1	Coral fragments (large pieces)	Port rear, tube 12
21	12	TBE	18:29	48	16.628	-9	39.095	360.2	Anemone & cup coral	Port rear, tube 9
21	13	TBE	18:38	48	16.628	-9	39.095	360.2	Fossil coral (?). May have fallen out	Front right, tube 7
21	14	BIOB	18:43	48	16.628	-9	39.095	360.1	Anemone on large(ish) rock	Back section of forward bio box
21	15	TBE	18:56	48	16.619	-9	39.086	359.2	Cup coral on fossil coral	Mid left, tube 11
30	1	BIOB	18:24	50	21.612	-7	36.44	85	Yellow Sponge	FWD Biobox
30	2	RCK	NOT LOG	50	21.612	-7	36.44	84	Rock cupcorals with	Tool Tray
30	3	SLP	18:52	50	21.6119	-7	36.4391	84	?Anemone: Broken	White Slurp
30	4	BIOB	19:10	50	21.61208	-7	36.4382	84	Rock encrusting bryozoan	FWD Biobox
30	5	TBE	19:29	50	21.61179	-7	36.4383	84	Porella	Biotube 9
33	1	SLP	17:12	50	15.1017	-7	36.54131	89.8	Yellow Sponge	White slurp
33	2	SLP	17:48	50	15.12224	-7	36.48547	97.6	Large Tube Anemone	Black Slurp
33	3	SLP	17:56	50	15.12	-7	36.4853	97	Erect Sponge, grey	Green Slurp
33	4	BIOB	18:03	50	1.4646	-7	36.4859	97	Rock with anemone	FWD Biobox
33	5	SLP	18:26	50	15.155	-7	36.494	97	Large Anemone on rock	Yellow Slurp
33	6	SLP	19:02	50	15.194	-7	36.499	86.8	Starfish	Red Slurp
43	1	n/a	11:35	48	30.55926	-9	51.0820	?	Accidental coral sampling. Failed PSH attempt, soft sand, some sand fell in green 1 tube	On top of ROV
43	2	SLP	12:32	48	30.48	-9	50.8912	520.6	Collection of holothuroidea specimen	White slurp
50	5	Tray	14:14	48	26.31715	-9	45.35639	1219	Protoptilium (Sea pen) Very large	Tool Tray

Table 10.3 Biological samples preserved during JC166. Individual numbers refer to individual animals or grouped samples. Letters are used when subsamples of an individual animal were obtained.

Ind. no	Station	Dive	Event	Taxon	Sample type	Preservation	Container	Comment
1	21	340	4	Holothurian	Individual	-80C freezer	Bag	
1a	21	340	4	Holothurian	tissue	-80C freezer	1.5ml centrifuge tube	
1b	21	340	4	Holothurian	gut	RNA later	1.5ml centrifuge tube	posterior gut
1c	21	340	4	Holothurian	gut	-80C freezer	1.5ml centrifuge tube	posterior gut
1d	21	340	4	Holothurian	gut	RNA later	1.5ml centrifuge tube	Evacuated gut, no sediment in anterior gut so picked first sediment (approx mid gut)
1e	21	340	4	Holothurian	gut	-80C freezer	1.5ml centrifuge tube	Evacuated gut, no sediment in anterior gut so picked first sediment (approx mid gut)
2	21	340	NA	Fish and amphipod	Individual	Ethanol	50ml tube	Found in push core tray
3	21	340	5	Anemone	Individual	Ethanol	500ml bottle	three hormanthid anemones (look the same species)
4	21	340	14	Anemone	Individual	Ethanol	50ml tube	Anemone picked off rock (individual 08)
5	21	340	5	Cup coral	Individual	Ethanol	50ml tube	
6	21	340	8	Squat Lobster	Individual	Ethanol	50ml tube	
7	21	340	14	Polychaete	Individual	Ethanol	50ml tube	Polychaete picked off membraneous tube on rock (individual 08)
8	21	340	14	Rock	Individual	Dry	Bag	Rock with cupcoral. Had anemone and polychaetes on (preserved separately)
9	21	340	8	Coral rubble	Collection	Dry	Bag	
10	21	340	8	Brachiopod	Individual	Ethanol	15ml tube	Attached to dead coral
11	21	340	4	Shrimp	Individual	Ethanol	15ml tube	Mid water shrimp (amphipod?) from suction sample
12	21	340	8	Ophiuroid	Individual	Ethanol	15ml tube	from biotube 8

13	21	340	NA	Shrimp	Individual	Ethanol	15ml tube	from slurp sampler waste material (yellow sampler)
14	21	340	NA	Squat Lobster	Individual	Ethanol	15ml tube	from slurp sampler waste material (yellow sampler)
15	21	340	3	Coral rubble	Collection	Dry	Bag	
16	21	340	12	Cup coral	Individual	Ethanol	50ml tube	
17	21	340	12	Anemone	Individual	Ethanol	50ml tube	
18	21	340	15	Cup coral	Individual	Ethanol	50ml tube	
19	21	340	NA	Ophiuroid	Individual	Ethanol	50ml tube	from slurp sampler waste material (yellow sampler)
20	21	340	11	Coral rubble	Collection	Dry	Bag	
21	21	340	11	Ophiuroid	Individual	Ethanol	15ml tube	Inside coral rubble (ind 20)
22	21	340	9	Coral rubble	Collection	Dry	Bag	
23	21	340	11	Ophiuroid	Individual	Ethanol	15ml tube	Inside coral rubble (ind 20)
24	21	340	3	Ophiuroid	Individual	Ethanol	2ml tube	
25	21	340	NA	Ophiuroid	Individual	Ethanol	15ml tube	from slurp sampler waste material (yellow sampler)
26	21	340	3	Brachiopod	Individual	Ethanol	15ml tube	
27	21	340	3	Ophiuroid	Individual	Ethanol	2ml tube	
28	21	340	3	Hydroid and ophiuroid	Individual	Ethanol	50ml tube	Dead coral fragment with attached hydroids and internal ophiuroid
29	21	340	3	Sponge?	Individual	Ethanol	50ml tube	Dead coral fragment with small stalks (possibly hexactinellid sponges)
30	30	341	2	Rock with cup corals + hydroids	Individual	Ethanol	Bucket	
31	30	341	5	Porella (branching white/pink bryozoan)	Individual	Ethanol	500ml bottle	Branching white/pink bryozoan
32	30	341	5	Gastropod	Individual	Ethanol	50ml tube	
33	30	341	5	Hermit crab	Individual	Ethanol	2ml tube	
34	30	341	5	Squat lobster	Individual	Ethanol	15ml tube	
35	30	341	3	Gastropods	Individual	Ethanol	15ml tube	
36	30	341	3	Hermit crab	Individual	Ethanol	2ml tube	
37	30	341	3	Ophiuroids	Individual	Ethanol	2ml tube	
38	30	341	3	Polychaete	Individual	Ethanol	2ml tube	
39	30	341	1	Cup sponge	Individual	Ethanol	500ml bottle	

40	30	341	4	Rock with cup corals	Individual	Ethanol	Bucket	Rock with cup coral + red encruster
41	33	342	1	Yellow Sponge	Individual	Ethanol	50ml tube	Had Skeleton shrimp (IND 42), and an amphipod (IND 43) on it
42	33	342	1	Skeleton Shrimp	Individual	Ethanol	15ml tube	Found on yellow sponge (IND 41)
43	33	342	1	Amphipod	Individual	Ethanol	2ml tube	Found on yellow sponge (IND 41)
44	33	342	5	Bolocera	Individual	Ethanol	1100ml bucket	
45	33	342	6	Stichastrela	Individual	Ethanol	50ml tube	
46	33	342	6	Cup Coral	Individual	Ethanol	50ml tube	
47	33	342	2	Ophuroid	Individual	Ethanol	15ml tube	
48	33	342	2	Aneomone	Individual	Ethanol	15ml tube	
49	33	342	2	Polychaete	Individual	Ethanol	2ml tube	
50	33	342	2	Tube Aneomone tube	Individual	Ethanol	Basg	
51	33	342	4	Anemone on Rock	Individual	Ethanol	50ml tube	
52	33	342	3	Erect Sponge	Individual	Ethanol	50ml tube	
53	33	342	3	Bryozoan	Individual	Ethanol	15ml tube	
54	43	343	2	Holothurian	Individual	Ethanol	1500ml	In same container as IND 55 and 56
54a	43	343	2	Holothurian	Tissue	-80	1.5 ml	Bodywall
54b	43	343	2	Holothurian	Tissue	-80	1.5 ml	Anterior Gut
54c	43	343	2	Holothurian	Tissue	RNA later	1.5 ml	Anterior Gut
54d	43	343	2	Holothurian	Tissue	-80	1.5 ml	Posterior Gut
54e	43	343	2	Holothurian	Tissue	RNA later	1.5 ml	Posterior Gut
55	43	343	2	Holothurian	Individual	Ethanol	1500ml	In same container as IND 54 and 56
55a	43	343	2	Holothurian	Tissue	-80	1.5 ml	Bodywall
55b	43	343	2	Holothurian	Tissue	-80	1.5 ml	Anterior Gut
55c	43	343	2	Holothurian	Tissue	RNA later	1.5 ml	Anterior Gut
55d	43	343	2	Holothurian	Tissue	-79	1.5 ml	Posterior Gut
55e	43	343	2	Holothurian	Tissue	RNA later	1.5 ml	Posterior Gut
56	43	343	2	Holothurian	Individual	Ethanol	1500ml	In same container as IND 54 and 55
56a	43	343	2	Holothurian	Tissue	-80	1.5 ml	Bodywall
56b	43	343	2	Holothurian	Tissue	-80	1.5 ml	Anterior Gut
56c	43	343	2	Holothurian	Tissue	RNA later	1.5 ml	Anterior Gut
56d	43	343	2	Holothurian	Tissue	-78	1.5 ml	Posterior Gut
56e	43	343	2	Holothurian	Tissue	RNA later	1.5 ml	Posterior Gut
57	43	343	1	Lophelia	Individual	Ethanol	Bucket	
57a	43	343	1	Lophelia	tissue	Ethanol	500 ml	
57b	43	343	1	Lophelia	tissue	Ethanol	500 ml	
58	43	343	1	Desmophyllum	Individual	Ethanol	1500 ml	
58a	43	343	1	Desmophyllum	tissue	Ethanol	500ml	

58b	43	343	1	Desmophyllum	tissue	dry	Bag	
59	43	343	2	polychaetes	Individual	Ethanol	1.5ml centrifuge tube	Parasite found on holothurian individual 56
60	43	343	1	Squat Lobster	Individual	Ethanol	15 ml	
61	43	343	1	Fish	Individual	Ethanol	16 ml	myctophid?
62	43	343	1	Polychaetes	Individual	Ethanol	17 ml	
63	43	343	1	Hydroids	Individual	Ethanol	18 ml	
64	43	343	1	Squat Lobster	Individual	Ethanol	19 ml	
65	50	345	5	Protoptilium (Sea pen)	Individual	Ethanol	Bag	
65a	50	345	5	Protoptilium (Sea pen)	Tissue	Ethanol	2ml tube	
65b	50	345	5	Protoptilium (Sea pen)	Tissue	Ethanol	2ml tube	



Figure 10.1. Example images of specimens collected during JC166 (digitally manipulated photomontages). Please note that individual animals are at different scales. Scaled photographs were taken and are stored digitally for almost all individual specimens.

1.57. ROV pushcores

Over the 6 ROV dives, 20 pushcores were taken (Table 10.4). In most cases they were acquired in groups of two or three, with one pushcore allocated to general sedimentology & geology of the area, one to organic matter content analysis and, if there was a third one, to microplastics analysis.

Table 10.4. Overview of pushcores taken during JC166

Final sample number	JDay	Date	Time GMT	Lat	Long	Water depth meter	Comments
JC166-021-ISIS340/PSH01	176	25/06/2018	14:41:00	48.2817	-9.6592	378	Good core.
JC166-021-ISIS340/PSH02	176	25/06/2018	14:43:00	48.2817	-9.6592	378	Good core.
JC166-021-ISIS340/PSH03	176	25/06/2018	16:43:00	48.2802	-9.6540	363	Good core.
JC166-021-ISIS340/PSH04	176	25/06/2018	16:45:00	48.2802	-9.6540	363	Good core (c. 10 cm sediment).
JC166-021-ISIS340/PSH05	176	25/06/2018	18:03:00	48.2772	-9.6517	361	Sample may have fallen out.
JC166-021-ISIS340/PSH06	176	25/06/2018	18:04:00	48.2772	-9.6517	361	Good core.
JC166-043-ISIS343/PSH01	183	02/07/2018	12:35:00	48.5080	-9.8482	521	Sandy mud for microplastics analysis.
JC166-043-ISIS343/PSH02	183	02/07/2018	12:37:00	48.5080	-9.8482	520	Sandy mud for organic matter analysis.
JC166-043-ISIS343/PSH03	183	02/07/2018	12:38:00	48.5080	-9.8482	520	Sandy mud for geological analysis.
JC166-043-ISIS343/PSH04	183	02/07/2018	14:13:00	48.5058	-9.8442	447	Practice push core
JC166-043-ISIS343/PSH05	183	02/07/2018	15:04:00	48.5031	-9.8420	390	Full mud core WP098 for microplastics analysis and corals.
JC166-043-ISIS343/PSH06	183	02/07/2018	15:06:00	48.5031	-9.8420	390	Full mud core WP098 for geological analysis.
JC166-043-ISIS343/PSH07	183	02/07/2018	15:08:00	48.5031	-9.8420	390	Full mud core WP098 for organic matter analysis.
JC166-047-ISIS344/PSH01	184	03/07/2018	15:34:00	47.7763	10.0915	3875	Half-full push core (stiff carbonate mud) for microplastics analysis.
JC166-047-ISIS344/PSH02	184	03/07/2018	15:38:00	47.7763	10.0915	3875	2/3-full push core (stiff carbonate mud) for geological analysis. Mud on outside.
JC166-047-ISIS344/PSH03	184	03/07/2018	15:43:00	47.7763	10.0915	3875	Half-full push core (stiff carbonate mud) for organic matter analysis.
JC166-050-ISIS345/PSH01	185	04/07/2018	13:54:00	48.4396	-9.7559	1220	push core failed, fine sand and mud
JC166-059-ISIS345/PSH02	185	04/07/2018	13:59:00	48.4396	-9.7556	1220	surface sediment potentially disturbed. Microplastic analysis
JC166-050-ISIS345/PSH03	185	04/07/2018	13:00:00	48.4396	-9.7556	1220	70% full, mud, strata apparent. Geology analysis
JC166-050-ISIS345/PSH04	185	04/07/2018	14:11:00	48.4386	-9.7559	1220	new location mud with some sand

For general geology, we tried to set aside the longest core of the three, to provide the longest record back in time for further study. Overstanding water was siphoned off, the bottom of the core was capped & sealed with electrical tape, after which any excess liner at the top of the core was cut off (with a hacksaw – tends to create a lot of plastic ‘sawdust’) and top of the core was also capped & sealed. The cores were labelled on the top and side, and stored in the fridge.

The cores for organic matter analysis were treated in a similar way: capped and sealed at the bottom, but then only part of the overstanding water was siphoned off – ca. 5cm was left on top of the core to minimise the disturbance of the sediment-water interface. The liner was also not cut, but a cap was put on top to avoid contamination. The cores were then placed upright into the -20°C freezer.

For microplastics analysis (by Dr. Katsia Pabortsava), care was taken to minimise contamination, e.g. by microplastics in the air in the lab etc. Cores were kept covered with ashed aluminium foil as much as possible. The overstanding water was siphoned off through a 250 µm sieve, and the remains on the sieve were transferred into an ashed glass jar. The top 1 cm of sediment was then carefully sliced off using a metal cutting plate, and added to the glass jar. To provide a 'pseudo-control' sample, the core section 10-11 cm was also sliced and preserved into a separate ashed jar. The samples will be dried in the oven and processed for further analysis once back at NOC.

1.58. ROV Video Imagery, photography and Lighting

The video and photography set-up during JC166 was the same in principle as during JC125, although different camera types were tested during JC166 (see section 2.7.7.2). Imaging and lighting equipment (Fig. 10.2) carried by the *Isis* ROV included three optically corrected High-Definition (HD) cameras mounted to the front of the vehicle.

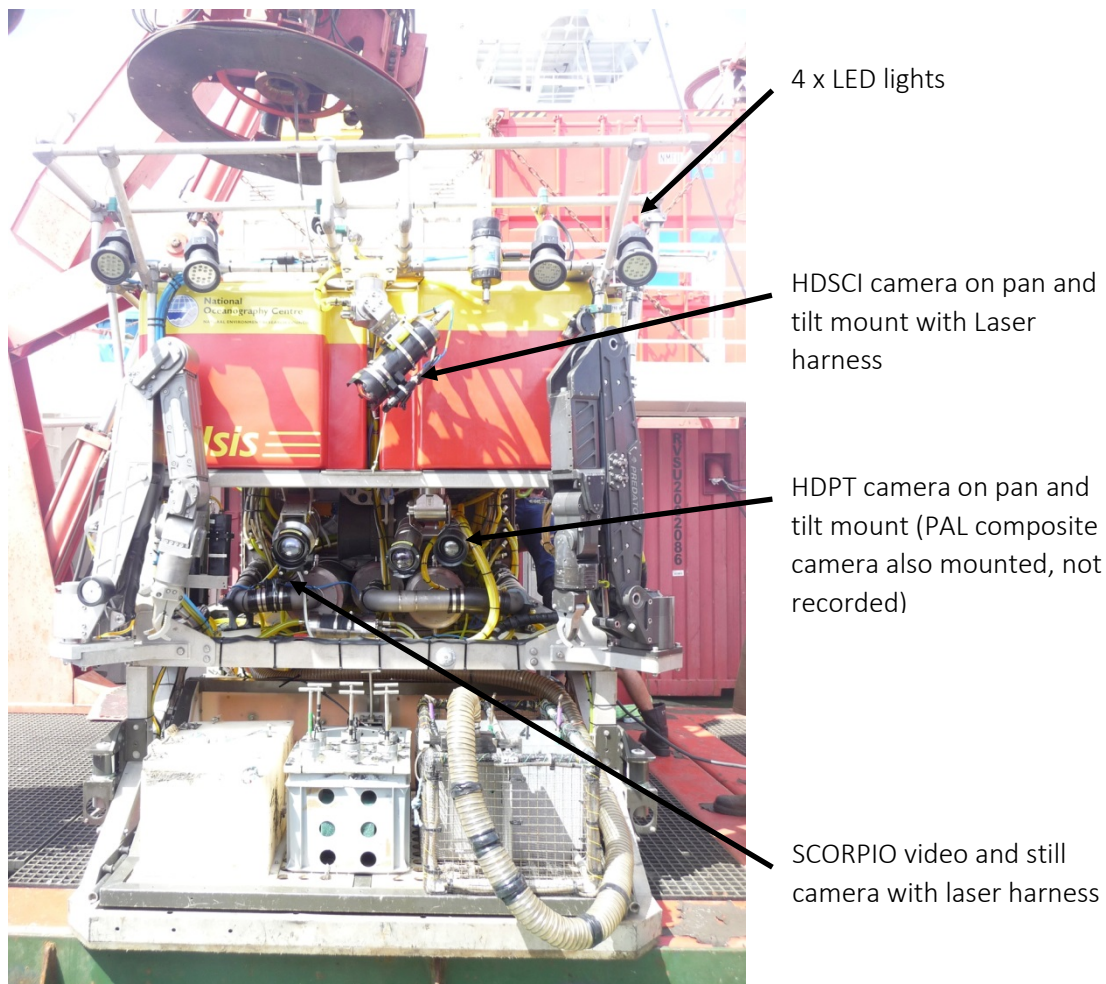

Fig. 10.2. *Isis* ROV video camera configuration

The HDPT (HD Pilot) camera was mounted on a pan-and-tilt module central to the vehicle and was

used primarily for piloting and sampling procedures. HDSCI (HD Science) was also mounted on a pan-and-tilt module above the HDPT, central to the vehicle. Watch leaders and the scientific party have full control of the pan-and-tilt and zoom functions of this camera during dive operations. The HD video and stills camera (SCORPIO) was mounted on a fixed bracket on starboard of the centre line of the vehicle. Other cameras on the *Isis* ROV used for piloting (not recorded for science) include numerous composite video cameras and one low-light aft camera.

Four LED lamps provided illumination for the cameras on a fixed-mount lighting bar at the front of the vehicle (Fig. 10.2). To provide a fixed scale in images, two sets of lasers were mounted 0.1m apart parallel to the focal axis of the HDSC and SCORPIO cameras.

All of the HD camera feeds correspond to an AQA dual KiPro recording deck in the *Isis* ROV control van. At the start of each dive the timecode was checked so that all videos are correctly time-stamped (GMT). In addition, on arrival at the seafloor, the internal timestamp of the SCORPIO camera was synced with that of the KiPro deck recording the SCORPIO HD feed. Each KiPro deck and camera has three corresponding 300GB solid-state drives (SSD). At the start of the cruise, it was decided that all three HD camera feeds would be recorded (Apple ProRes 422, 1920 x 1080).

Recording would commence on deployment, and would continue to record on descent to the seabed. On the seabed, all three cameras were stopped simultaneously and the KiPro recording deck was changed to a second SSD. During operational dive hours, the video footage was recorded in 2-hour files of approximately 110GB each. On approaching the seabed, the HDSCI, HDPT and SCORPIO cameras were white balanced to provide the best representation of true colour at the depth of the imagery being recorded. The total number of hours of video recorded (bottom time) for each dive is shown in Table 4.3. As soon as the vehicle left the seabed, the KiPro recording disks were changed again, to enable easier extraction of 'on bottom' footage.

During operational dive hours the SCORPIO camera was set to take stills images (4672 x 2628; 16:9 Format) every 10 seconds. The 'snap photo' command could be used on the DEVCON GUI to capture extra stills – this had no effect on the images taken at 30-second intervals. Where possible, the 'field of view' on the SCORPIO camera was maintained. As a result of the variable topography of the seafloor (steep vertical walls to flat slopes), the GUI was used to zoom in or out where appropriate.

1.59. ROV metadata

During ROV dives, an extensive suite of data are recorded that describe all aspects of the operation: ROV USBL navigation, ROV Doppler navigation, depth, attitude, ship navigation,... These data are recorded in the central *Isis* database and stored in NetCDF format. At the end of each dive they are also converted into ASCII format and both sets of files are provided to the scientists to help with the analysis of the ROV video data. The most comprehensive files are the *Dive***.ISCSV* files, comma-separated files which contain the following parameters:

Field Name Units

Latitude deg

Longitude deg

csvX m

csvY m

Lat Origin deg

Lon Origin deg
Xutm m
Yutm m
UTM Zone
Depth m (Isis Parascientific Digiquartz Pressure Sensor)
Altitude m (Isis Kongsberg Altimeter)
Heading deg (Isis Octans, MRU)
Octans Pitch deg
Octans Roll deg
Xbw Head deg (Isis Crossbow compass)
Xbw Pitch deg
Xbw Roll deg
Wraps Number of turn in Isis umbilical

Ship systems

Operations: Juan Ward

Scientific Ship Systems (SSS) is responsible for managing the Ship's scientific information technology infrastructure, data acquisition, compilation and delivery, and the suite of ship-fitted instruments and sensors.

All times in this report are in UTC.

1.60. Scientific computer systems

1.60.1. Acquisition

Data from the suite of ship-fitted scientific instrumentation was aggregated onto a network drive on the ship's file server. This was available throughout the voyage in read-only mode to permit scientists to work with the data as it was acquired. A Public network folder was also available for scientists to share files.

A copy of these two drives are written to the end-of-cruise disks that are provided to the Principal Scientist and the British Oceanographic Data Centre (BODC).

List of logged ship-fitted scientific systems:
`/CRUISE_REPORTS/JC166_Ship_fitted_information_sheet.docx`

Data was logged by three acquisition systems:

1. Ifremer TECHSAS 5.11, which produces NetCDF and ASCII output data files.
2. NMF RVDAS, which records the raw NMEA output of instruments.
3. RVS Level-C, which produces a legacy format still used by some scientists and ASCII.

There is a data description document for each instrument provided on the cruise datastore.

Data structure description documents:
`/Ship_Systems/TECHSAS/Data Description/`

The data directories of each acquisition system are as follows:

<i>TECHSAS</i> <code>/Ship_Systems/TECHSAS/</code>	<i>data</i>	<i>directory:</i>
<i>RVDAS</i> <code>/Ship_Systems/Raw_NMEA/</code>	<i>data</i>	<i>directory:</i>
<i>Level-C</i> <code>/Ship_Systems/Level-C/</code>	<i>data</i>	<i>directory:</i>

1.60.1.1. Significant acquisition events or losses

Due to a software failure, there was no TECHSAS or Level-C acquisition for the first hour of the cruise as the vessel left Southampton. An older backup system was deployed instead, but it is not configured to properly acquire the SkipperLog instrument, which provides vessel speed-through-water. The raw SkipperLog data was nonetheless recorded by RVDAS, which ran without problems throughout the cruise.

1.60.2. Internet provision

Satellite communications were provided with both the VSat and Fleet Broadband systems. The VSat had a guaranteed download rate of 1.5 Mb/s with the potential of faster rates when the demand can be accommodated by the satellite. The Fleet Broadband had a maximum un-guaranteed speed of 256 kb/s and a cap of around 15 GB per month.

An issue with the 001W satellite soon after departing Southampton resulted in 024W and 053W being chosen as the favoured satellites for this voyage. This resulted in temporary outages when the ship's heading was set to north-east, due to blockage from the mast. During these periods, the Fleet Broadband provided a limited email service.

While underway, the ship operated with a restricted internet connection, but with an unrestricted Wi-Fi hotspot in the Lounge.

1.60.3. Outreach and streaming provision

Two methods of streaming from the HyBis and ROV were trialled.

The first took the PAL output from the HyBIS Scorpio camera and encoded to MJPEG over HTTP, which was then converted into FLV over RTMP to stream to the IBM uStream platform.

The second saw an HDMI from the ROV Scorpio camera connected the ROV BlackMagic UltraStudio to a MacMini via Thunderbolt. The Open Broadcasting Software (OBS) was used with custom broadcast settings to stream FLV over RTMP to the IBM uStream platform.

With the second method, it was easier to configure the output quality of the stream as the OBS provides a helpful graphical user interface with feedback. The first method used FFMPEG to control the quality of the stream, which relied upon trial-and-error to converge upon a decent output quality.

The impact on the ship's internet performance was negligible during both trials, possibly because the VSat provision has both a guaranteed upload rate and download rate. Naturally, however, there will be a threshold over which increasing broadcast quality will result in decreasing internet responsiveness, but this limit has not been reached during the trials.

1.61. Instrumentation

1.61.1. Coordinate reference

1.61.1.1. Datum

The common coordinate reference was defined by the Blom Maritime survey (2006) as:

1. The reference plane is parallel with the main deck abeam (transversely) and with the baseline (keel) fore- and aft-ways (longitudinally).

2. Datum ($X = 0, Y = 0, Z = 0$) is centre topside of the Applanix motion reference unit (MRU) chassis.

1.61.1.2. Multibeam

The Kongsberg axes reference conventions are (see Figure 1) as follows:

1. X positive forward,
2. Y positive starboard,
3. Z positive downward.

The roll reference is set to follow the convention of Applanix PosMV.

1.61.1.3. Applanix PosMV Primary scientific position and attitude system

The translations and rotations provided by this system have the following convention:

1. Roll positive port up,
2. Pitch positive bow up,
3. Heading true,
4. Heave positive up.

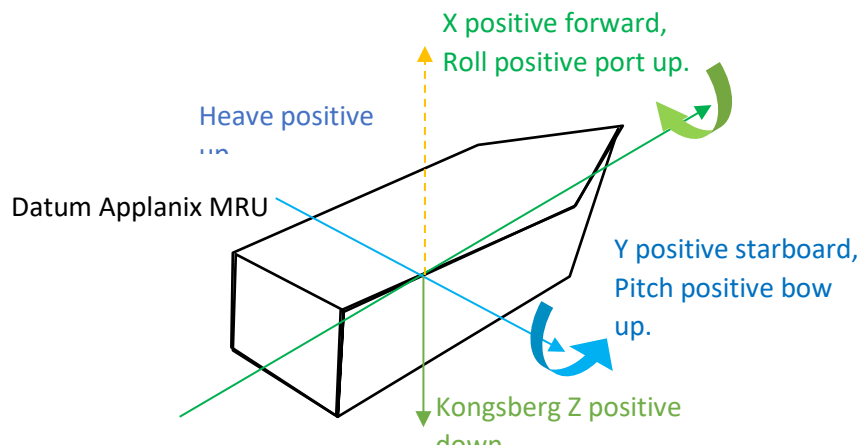

Figure 11.1 Conventions used for position and attitude.

1.61.2. Position and attitude

Positioning and attitude measurement systems were run and recorded throughout the cruise.

The **Applanix PosMV** is the ship's primary scientific GPS system, outputting the position of the ship's common reference point at the Applanix MRU in the gravity meter room and the attitude of the ship as NMEA sentences. These NMEA sentences are repeated around the ship via serial RS232 to systems that require time and position, such as the EM122 and EM710. These are further logged by the Acquisition systems. The PosMV can estimate position to within 5 metres and is then further corrected by differential correction messages from the ship's CNAV DGNSS system.

The **Kongsberg Seapath 330** is the ship's secondary GPS system, used for dynamic positioning. A feed from the Seapath is used for the EM122 and EM710, other scientific systems and is logged by the Acquisition systems.

The **CNav 3050** is the ship's primary differential correction service. Dynamic positioning requires the ship to be equipped with two DGPS systems so that the vessel can station-keep to a high degree of accuracy with failover redundancy. The CNav provides the Applanix PosMV and Seapath 330 with RTCM DGPS corrections (accuracy greater than 1 metre), and these positions are logged by the Acquisition systems.

1.61.2.1. Significant position and attitude events or losses

There were no significant events or losses with the position and attitude systems.

1.61.3. Ocean and atmosphere monitoring systems

The NMF Surfmet system was run throughout the cruise, excepting times for cleaning, entering and leaving port, and whilst alongside. Please see the separate information sheet for details of the sensors used and whether their recorded data have calibrations applied or not.

Details of NMF Surfmet configuration:
/CRUISE_REPORTS/JC166_Surfmet_sensor_information_sheet.docx

The Surfmet system is comprised of:

- Hull water inlet temperature probe (SBE38).
- Sampling board conductivity, temperature salinity sensor (SBE45).
- Sampling board transmissometer (CST).
- Sampling board fluorometer (WS3S)
- Met platform temperature and humidity probe (HMP45).
- Met platform port and starboard ambient light sensors (PAR, TIR).
- Met platform atmospheric pressure sensor (PTB110).
- Met platform anemometer (Windsonic).

The manuals and calibration sheets for these sensors are included on the cruise datastore.

Path of manuals and calibration certificates for Surfmet instruments:
/Ship_Systems/Met/SURFMET/

1.61.3.1. Surface water sampling events

Date UTC	Start	End	Event	Trans high (V)	Trans low (V)	Fluoro (V)	Salinity (PSU)
07/07/2018		12:00	Shutdown				

Whilst the surface water sampling system was cleaned prior to the cruise, no maintenance or cleaning was undertaken during the cruise as the area being used for storage, thus making the system difficult to access.

1.61.3.2. Drop keel sound velocity sensor

The surface Sound Velocity (SV) sensor (AML MicroX) is mounted on the port drop keel and is used to provide SV data to the EM122 and EM710. The port drop keel was deployed throughout the duration of the cruise.

1.61.3.3. Wave radar

The wave radar is out of calibration and was not run during this cruise.

1.61.4. Hydroacoustic systems

1.61.4.1. Kongsberg EA640 10/12 kHz single-beam

The EA640 single-beam echo-sounder was run throughout the cruise in free-running mode. Pulse parameters were varied to adapt to the depth.

The system was used with a constant sound velocity of 1500 m/s throughout the water column to allow it to be corrected in post-processing.

The depth NMEA was logged by the Acquisition systems while RAW and BMP files were aggregated onto the cruise datastore.

1.61.4.2. Kongsberg EM122 multibeam echo-sounder

The EM122 multibeam system was run for surveys off-shelf in free-running mode. The position and attitude data were supplied from the Kongsberg Seapath.

Sound velocity profiles were input from full-depth sound velocity probe casts. When these were not available, a statistical sound velocity profile was input from Ifremer's DORIS program.

The system was largely operated and configured by the science party.

The positions and rotations of the transducers are from the ship's survey report. The attitude angular corrections are derived from a patch test undertaken by the science party prior to survey (see Table 11.1 and Table 11.2, with modifications shown in brackets).

Table 11.1 Position of the EM122 transducers and MRUs within the Kongsberg coordinate system.

Item	X (m, + Forward)	Y (m, + Starboard)	Z (m, + Down)
Tx transducer	19.199	1.832	6.944
Rx transducer	14.092	0.954	6.926
Att 1 (Applanix)	0.000	0.000	0.000
Att 2 (Seapath)	-0.350	0.056	-0.373
Waterline (distance from Att 1 to W/L)			1.376

Table 11.2 Angular offsets of the EM122 transducers with respect to the MRUs.

Item	Roll (deg)	Pitch (deg)	Yaw (deg)
Tx transducer	-0.083	-0.235	0.018 (from 0.182)
Rx transducer	-0.063	0.034	0.133
Att 1 (Applanix)	0.150	0.120	-0.200
Att 2 (Seapath)	0.060	0.160 (from -0.04)	0.030

Path to CARIS EM122 vessel file:
/Ship_Systems/Acoustics/James_Cook_EM122.hvf

1.61.4.3. Kongsberg EM710 multibeam echo-sounder

The EM710 was used for on-shelf surveys in free-running mode, with the transducers deployed to 2.55m below the hull on a drop keel. The position and attitude were supplied by Kongsberg Seapath.

Sound velocity profiles were input from full-depth sound velocity probe casts. When these were not available, a statistical sound velocity profile was input from Ifremer’s DORIS program.

The system was largely operated and configured by the science party.

The positions and rotations of the transducers are from the ship’s survey report. The attitude angular corrections are derived from a patch test undertaken by the science party prior to survey (see Table 11.3 and Table 11.4).

Table 11.3 Position of the EM710 transducers and MRUs within the Kongsberg coordinate system.

<i>Item</i>	<i>X (m, + Forward)</i>	<i>Y (m, + Starboard)</i>	<i>Z (m, + Down)</i>
Tx transducer	5.415	-0.015	9.515 (from 6.960)
Rx transducer	4.988	0.013	9.515 (from 6.960)
Att 1 (Applanix)	0.000	0.000	0.000
Att 2 (Seapath)	-0.350	0.056	-0.373
Waterline (distance from Att 1 to W/L)			1.376

Table 11.4 Angular offsets of the EM710 transducers with respect to the MRUs.

<i>Item</i>	<i>Roll (deg)</i>	<i>Pitch (deg)</i>	<i>Yaw (deg)</i>
Tx transducer	-0.418	-0.228	0.000
Rx transducer	0.130	0.000	0.000
Att 1 (Applanix)	-0.450	0.680	-0.380
Att 2 (Seapath)	-0.460	0.390	-1.010

Path to CARIS EM710 vessel file:
 /Ship_Systems/Acoustics/James_Cook_EM710_Seapath_Keel_Down.hvf

1.61.4.4. Sound velocity profiles

Sound velocity profiles were either collected with the Midas SVP probe (22241) or calculated from the WOA13 model using Ifremer DORIS.

These were applied to the Sonardyne USBL system, and further by the science party to the EM710 and EM122 as required.

Path of sound velocity profile data on the cruise datastore:
 /Ship_Systems/Acoustics/Sound_Velocity_Profiles/

1.61.4.5. Acoustic doppler current profilers

The ADCPs were not run for any significant amount of time.

1.61.4.6. Sonardyne USBL underwater positioning system

The ship’s USBL poles were used with Scientific Ship Systems’ and others’ beacons to track underwater targets. In particular, the AUV group’s Autosub and the ROV group’s HyBIS and ISIS were tracked with Sonardyne Ranger2.

During this cruise there were two Navigation Sensor Hubs (NSHs) on-board: the permanent ship-fitted NSH and the ROV NSH. The USBL system was configured to feed the starboard transducer to the ROV NSH (in the ROV container) and the port transducer to the ship NSH (in the main lab).

The beacons tracked with the ship NSH were recorded by the Acquisition systems.

Path and pattern of USBL raw NMEA files:
/Ship_Systems/Raw_NMEA/JC166_RANGER2_USBL_*.nmea

Path and pattern of USBL NetCDF files:
/Ship_Systems/TECHSAS/NetCDF/GPS/*-position-Ranger2_USBL.gps

1.61.5. Geophysics systems

No geophysics systems were deployed on this cruise.

1.61.6. Other systems

1.61.6.1. EM Speed logs

The single-axis bridge Skipper Log and the dual-axis Chernikeef log were recorded throughout the cruise. The Chernikeef was calibrated in December 2017 offshore of Tenerife.

The Skipper Log is incorrectly configured in the version of Techsas that was running on this cruise. This data should be reconstructed using the raw NMEA recorded by RVDAS, following the data description document included on the cruise datastore.

INITIAL RESULTS AT HAIG FRAS (Noelie Benoist, Brett Hosking, James Strong, Dan Jones, Catherine Wardell, Ana Jesus, Veerle Huvenne, America Zelada)

1. Ship-based multibeam bathymetry mapping

Over the course of the cruise, the ship-based multibeam bathymetry data coverage over the Greater Haig Fras was extended considerably compared to the coverage obtained during JC124 (Fig. R.1). A significant offset between the dataset from JC124 and JC166 was noted, and was attributed to the fact that the draft correction was applied twice in the processed data of JC124. Corrections were applied retrospectively.

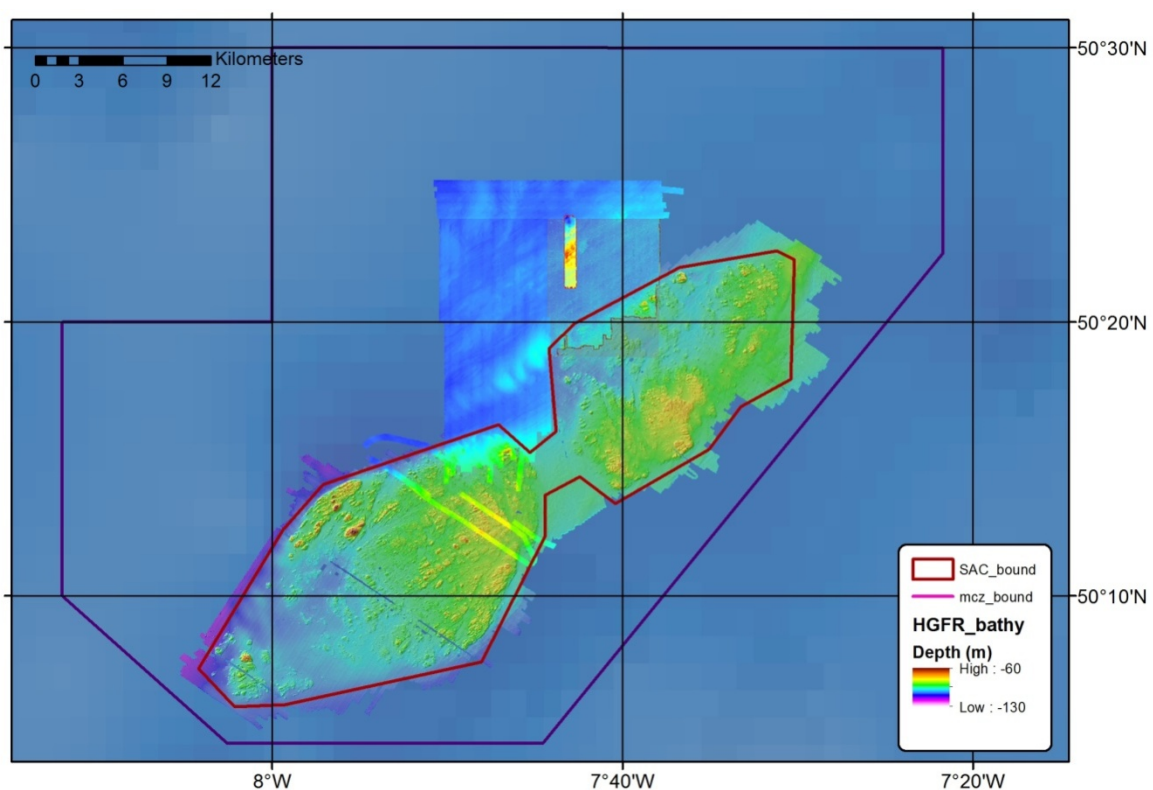

Fig. R.1 Extension of bathymetry data coverage obtained during JC166 (non-shaded bathymetry to the north and west of coverage obtained during JC124)

JC166 Autosub6000 repeat survey methodology

Two missions (M143, M144) were carried out, variously addressing: (i) the variance in repeat sidescan sonar imagery 12 hours apart, (ii) comparing ecological data 12 hours apart using seafloor photography (i.e. day vs. night), (iii) bathymetric mapping, and (iv) acquiring environmental data on the overlying water column (i.e. CTD). Each mission comprised multiple dives:

- 1. Mission 143, 27-28 July 2018, station number JC166-028:**
 - Camera trial** at 3 m target altitude, start time c. 17:30 GMT;
 - Sidescan sonar survey** at 15 m target altitude, start time c. 18:00 GMT;

Night-time photographic survey at 3 m target altitude, start time c. 23:00 GMT;
Sidescan sonar survey at 15 m target altitude, start time c. 04:15 GMT;
Day-time photographic survey at 3 m target altitude, start time c. 10:15 GMT.

2. Mission 144, 29-30 July 2018, station number JC166-034:

Night-time photographic survey at 3 m target altitude, start time c. 21:30 GMT;
Swath bathymetry survey at 50 m target altitude, start time c. 01:30 GMT.

Sensors. For missions 143 and 144, the key sensors were:

- Point Grey Research Grasshopper 2 digital camera with 10 J flashgun;
- EdgeTech 2200-FS dual frequency sidescan sonar (run at 410 kHz);
- EM2040 multibeam system;
- Seabird CTDs (Conductivity, Temperature, Depth instrument);
- RDI Teledyne 300 kHz ADCP.

Photographic set-up. For missions 143 and 144, two Grasshopper 2 camera systems (forward and downward oriented) were operated. For repeat ecological mapping, only the downward-looking photographs are likely to be analysed. The downward-oriented camera was positioned so that the image long-axis was parallel to the long-axis of the vehicle, with the left side of the image to the forward end of the vehicle. See below details of photographic set-up:

- Frame interval: 1000 mS;
- Camera down-angle: 90°;
- Lens type: Navitar;
- Lens focal length: 12 mm;
- Lens f number: c. 2;
- Focus in air: 2.5 m;
- Flash energy: 10 J;
- Shutter speed: 1 mS;
- Camera model: Point Grey Research, Grasshopper2, GS2-GE-50S5C;
- Imaging sensor: Sony ICX625AQ (2/3" 2448 x 2048 CCD);
- Resolution: 2448 x 2048 pixels;
- Image recording format: raw 8-bit, Bayer tile format: GBRG.

Multi-dive AUV mission operations. Mission 143 dive 1 allowed us to check that useful seafloor photographic images were being successfully acquired before proceeding with the rest of the mission. The multi-dive operations permitted us to check the correct operation of the vehicle and initiate each phase of the survey (M143 dives 2-5; M144 dive 2) with a new GPS fix at the surface. Dive tracks and profiles for missions 143 and 144 are shown in Figs. R.2 and R.3.

Issues with M143 AUV raw data logger. Day vs. night-time photographic surveys were planned to occur during mission 143. However, both the ADCP and the AESA camera system raw data logger sensors failed to record navigational data during mission 143 dive 3 (i.e. night-time). In addition, the AESA camera systems stopped recording photographs before the end of the survey track (i.e. at 01:52 GMT). For this reason, a second night-time photographic survey was programmed during mission 144 c. 48 h later.

Seafloor cable. Note that owing to the presence of a seafloor telecommunication cable lying south of the bedrock outcrop (Table R.1), *Autosub6000* was programmed to fly c. 15 m above the seafloor for 300 m (150 m either side of the cable) to prevent encountering the cable (in case it was not embedded in the seafloor).

Table R.1. Locations of a seafloor telecommunication cable as observed in 2012 and 2015 Autosub6000 photographs.

Year	Tile name	Latitude	Longitude
2012	M58_10441297_12987749196765	50.3681998	-7.7158131
2012	M58_10441297_12987756137840	50.3674452	-7.7207505
2012	M58_10441297_12987746768071	50.3689415	-7.7121081
2015	T1263	50.3683690	-7.7157376
2015	T3350	50.3672856	-7.7206189

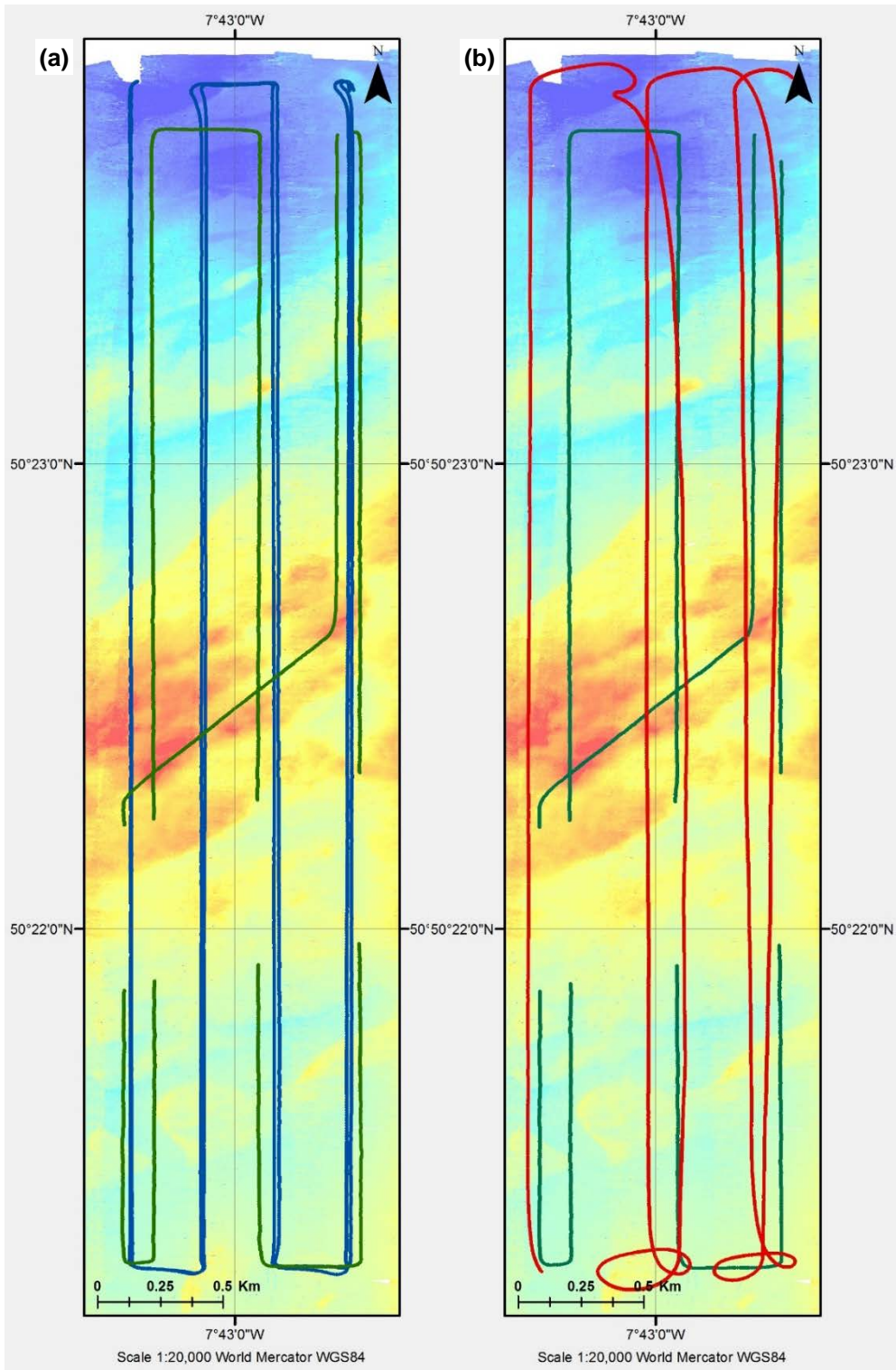

Fig. R.2. Track lines for Autosub6000. (a) Mission 143 dives 2, 4 (sidescan sonar backscatter, blue), and 5 (day-time photography, green). Note the absence of M143 dive 3 (night-time photography) track lines because no navigational data were recorded. (b) Mission 144 dives 1 (night-time photography, green) and 2 (bathymetry, red). Note the gaps on M143 and M144 photographic track lines correspond to the area surveyed around the seafloor telecommunication cable observed in 2012 and 2015 photographs. Track lines are overlaid on ship-based multibeam swath bathymetry map from previous JC124 cruise.

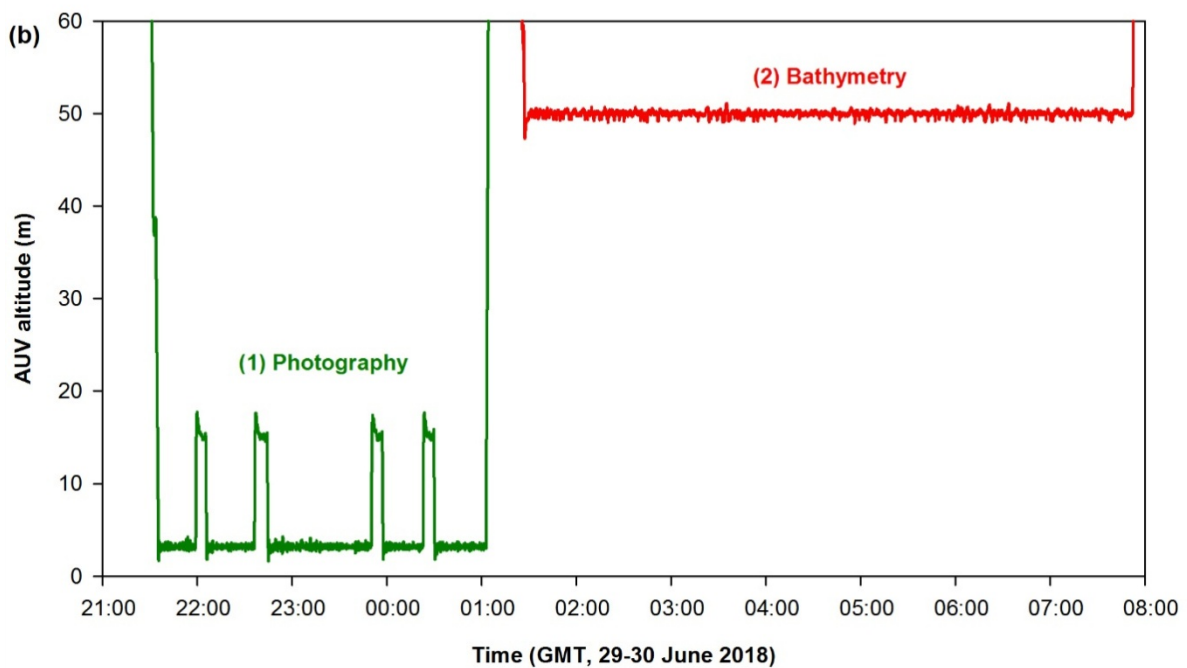
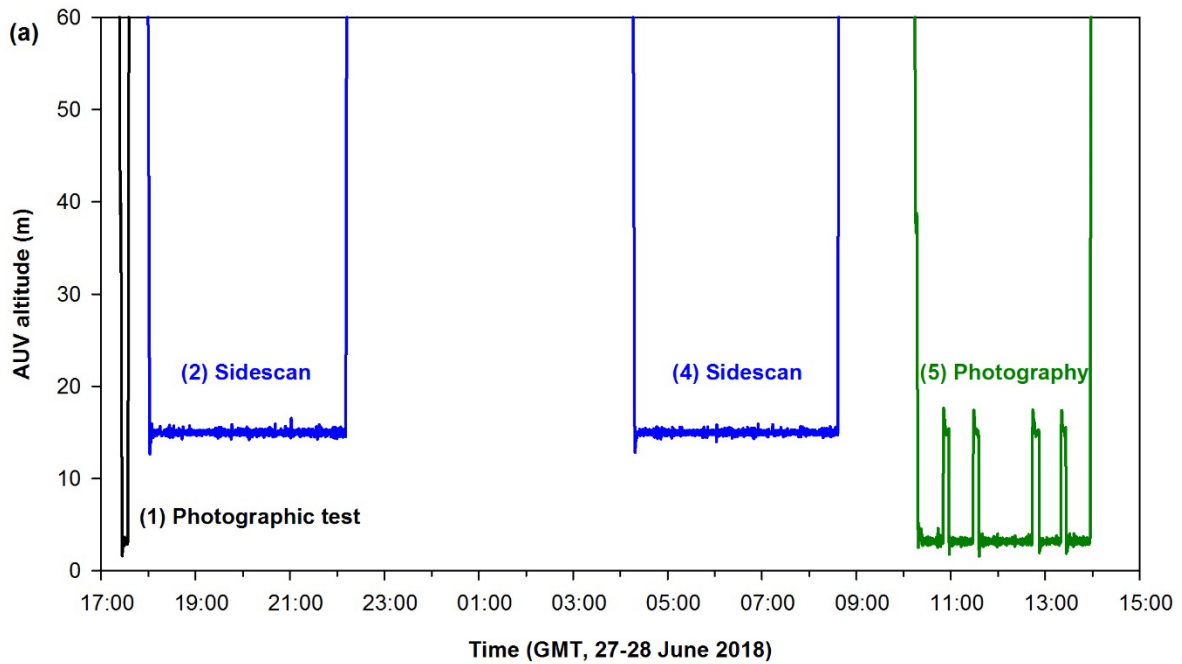

Fig. R.3. Dive profiles for Autosub6000 as vehicle altitude against time. (a) Mission 143 (dives 1, 2, 4, 5). Note the absence of M143 dive 3 (night-time photography) profile because no navigational data were recorded. (b) Mission 144 (dives 1-2). Note the four peaks on the photographic profiles (M143 dive 5, M144 dive 2) at c. 15 m altitude correspond to the area surveyed around the seafloor telecommunication cable observed in 2012 and 2015 photographs.

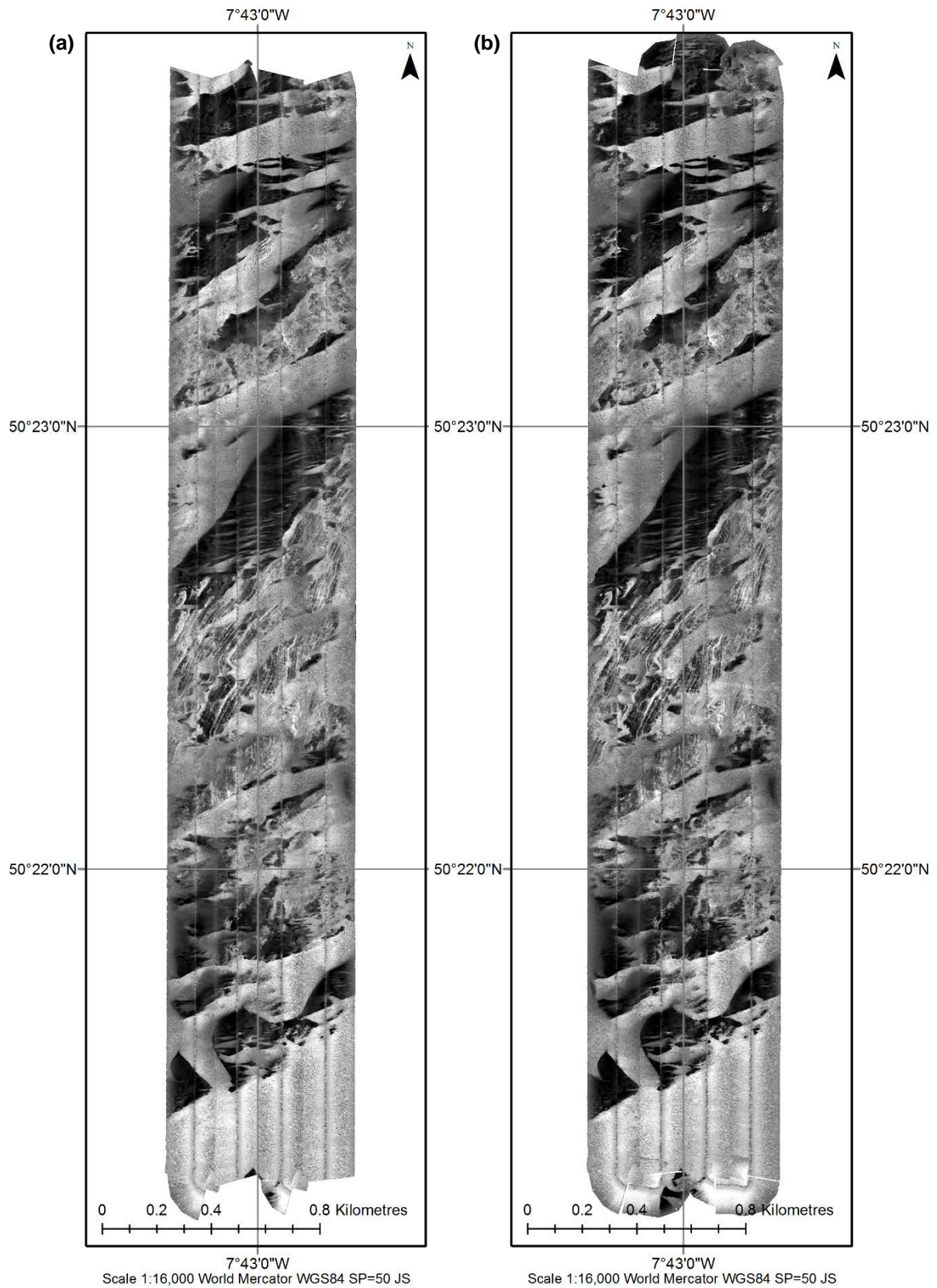

Fig. R.4. Autosub6000 mission 143 (a) dive 2 and (b) dive 4 sidescan sonar backscatter. (High backscatter, light; low backscatter, dark).

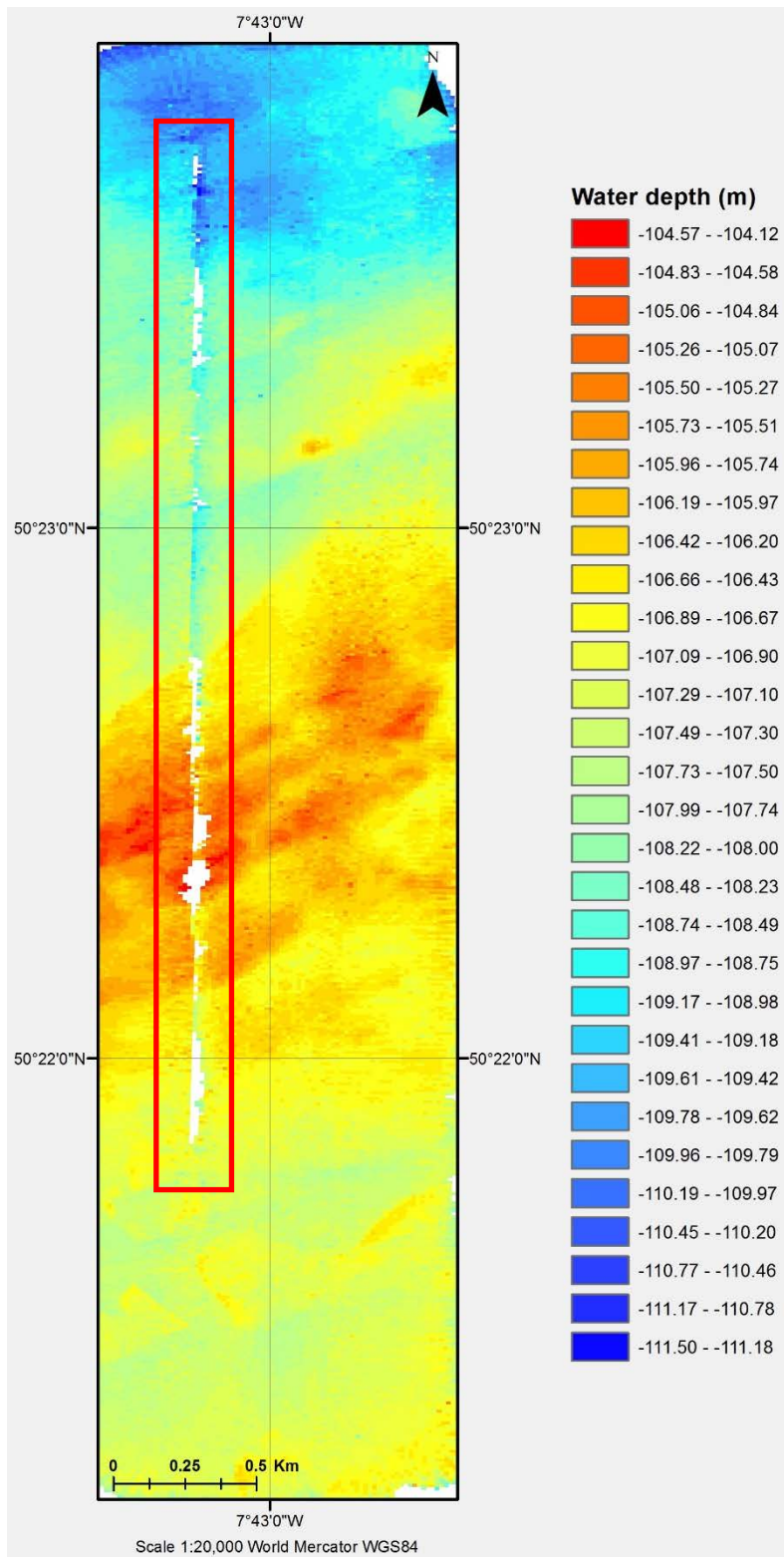

Fig. R.5. Autosub6000 mission 144 dive 2 multibeam swath bathymetry map. (Red box indicates area of missing data caused by non-overlapping survey tracks; see Fig. Haig_Fras_3.)

AUV-based seafloor morphology

For the sidescan sonar surveys (M143 dives 2 and 4), *Autosub6000* was flying at c. 15 m above the seabed and followed five c. 4.7 km transect lines separated by c. 180 m resulting in a total area mapped of c. 3.9 km² (Figs. R.2a, R.3a, R.4). Very little difference can be observed between the c. 24h-spaced sidescan sonar backscatter survey maps. In general terms, the sidescan data shows alternating bands of higher and lower backscatter having a broadly similar southwest to northeast trend that may be interpreted as changes from coarser mixed sediments (high backscatter) to finer more homogeneous sediments (low backscatter). Finer-scale details are apparent on close inspection of these data, particularly areas of sinusoidal striations on the central high region that correspond to outcropping rock strata (also observed in AUV photographs; Benoist et al. revised submission May 2018).

For the bathymetric survey (M144 dive 2), *Autosub6000* was flying at c. 50 m above the seabed and followed five c. 4.7 km transect lines resulting in a total area of c. 3.9 km² (Fig. R.2, R.3, R.5). Note during the dive the AUV likely followed the targeted waypoints in an incorrect order, resulting in non-equidistant transect lines, non-overlapping on the western side. Further data processing is required once back at NOC.

Ecological survey

1.1. CTD

Physical oceanographic information on the over-lying water column was acquired with CTD instruments during missions 143 and 144 (Fig. R.6,b). Data processed on board of the ship indicated the presence of potential problems in field data acquisition and processing using the CTD Seabird software on *Autosub6000*. Error checks revealed two main issues: (1) difference between the two CTD temperature sensors (i.e. primary cell, t090C, secondary cell, t190C); (2) time delay between the CTD cell sensors data and the AUV internal depth sensor data that appears to be causing the apparent hysteresis visible in Fig. R.5. Note this delay only occurred in mission 143 before the first AUV data logger problem occurred (i.e. dives 1, 2), which may be related to the initial start time input into the Seabird processing software.

For missions 143 and 144, according to the temperature data generated from the CTD secondary cell, a strong thermocline is apparent between 30 and 50 m water depth with c. 10 m variance in its location that may be caused by both temporal and spatial variations (Fig. R.6a, b bottom pane). For mission 143 and 144, salinity (as calculated by the CTD software based on the primary cell) and dissolved oxygen profiles exhibit artefacts that are a result of sensor calibration, and noise in the data is apparent at c. 20 m water depth (Fig. R.6,b). CTD data should be further processed and investigated once back at NOC.

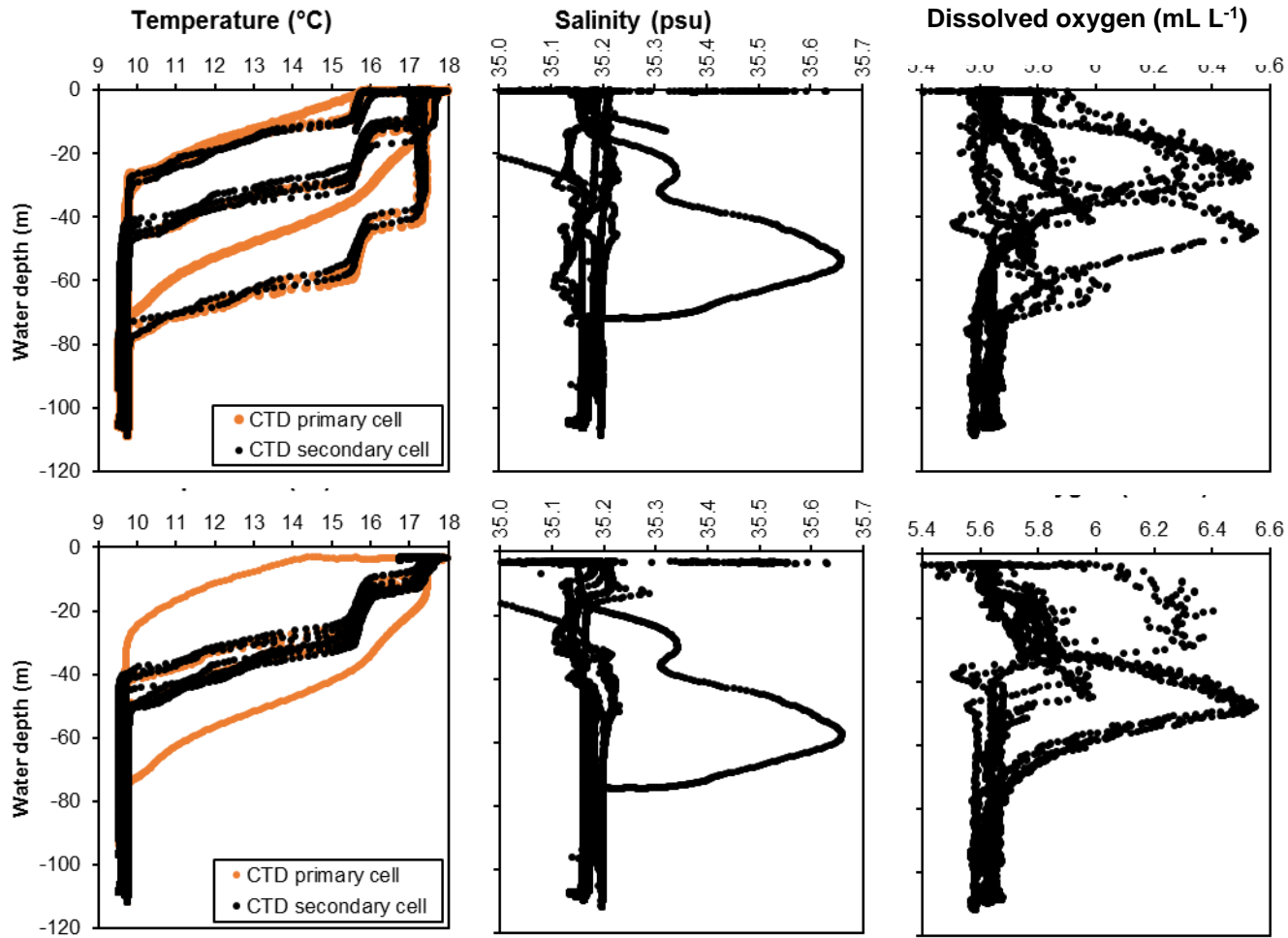

Fig. R.6a. Autosub6000 mission 143 dives 1-5 water column profiles of CTD instrument data – temperature (°C; left), salinity (psu; centre), dissolved oxygen (mL L⁻¹; right). Water depth (m) as determined by the AUV internal depth sensor (top pane) and by the CTD instrument (bottom panel).

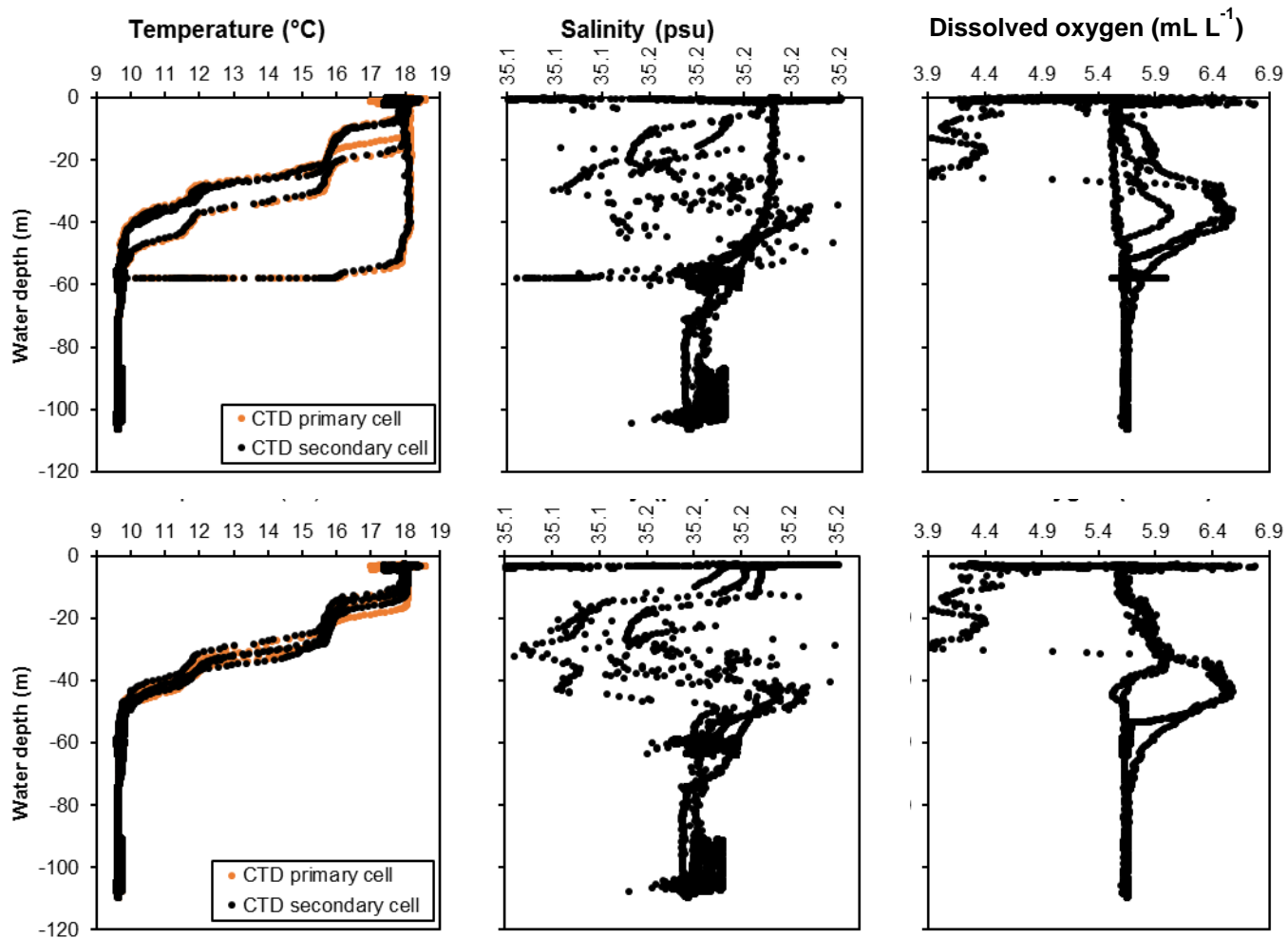

Fig. R.6b. Autosub6000 mission 144 dives 1-2 water column profiles of CTD instrument data – temperature (°C; left), salinity (psu; centre), dissolved oxygen (mL L⁻¹; right). Water depth (m) as determined by the AUV internal depth sensor (top pane) and by the CTD instrument (bottom pane).

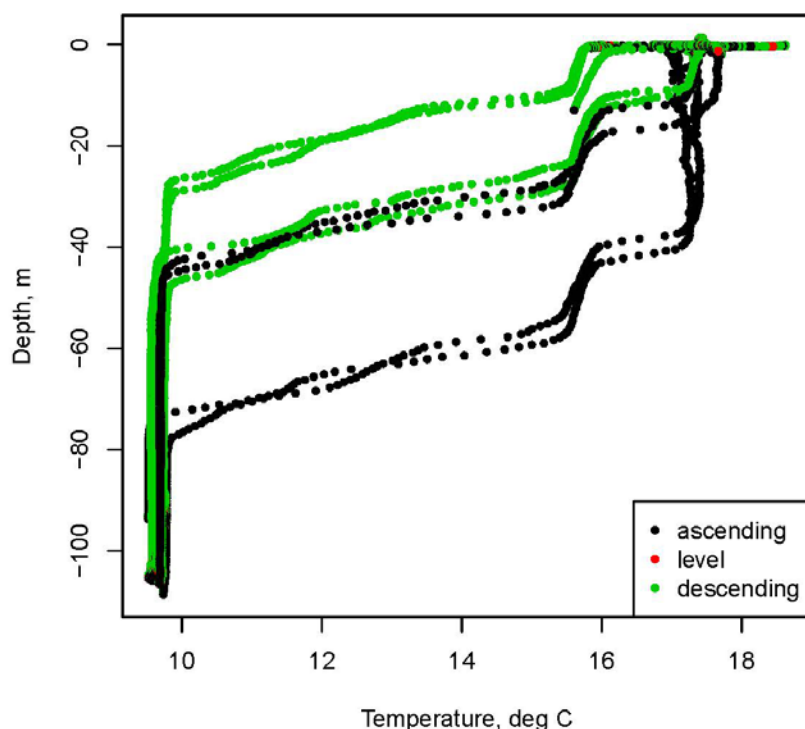

Fig. R.6c. Autosub6000 mission 143 dives 1-5 water column profiles of CTD instrument data showing the differing temperature data for the AUV ascent and descent. Water depth (m) as determined by the AUV internal depth sensor.

1.2. Photographic survey

During missions 143 (dives 3, 5) and 144 (dive 1) photographic surveys, *Autosub6000* was programmed to fly at a target altitude of c. 3 m above the seafloor and continuously record photographs of the benthos using the AESA camera systems (Figs. Haig_Fras_3, Haig_Fras_4). For repeat ecological mapping, only those photographs recorded from the downward facing camera were assessed on board of the ship. Due to the failure of the AUV data logger sensors during mission 143 dive 3, those seafloor photographs acquired do not have navigational information rendering it impossible to use for quantitative analysis. These images can be used for qualitative purpose, e.g. seabed habitat and taxonomic identification. Mission 143 dive 5 and mission 144 dive 1 successfully provided each in total c. 13,000 useful seafloor photographs (<6 m AUV altitude) and will be analysed (i) to assess any change in community composition between night and day, respectively, and (ii) to assess any change in community composition over time (i.e. 2012, 2015, 2018). During both missions, c. 2000 images were taken at c. 15 m above the seafloor where *Autosub6000* dived higher than the photographic survey target altitude in order to avoid possible contact with the telecommunication seafloor cable. These images will not be considered for photographic benthic mapping purposes. Details of photographic missions 143 and 144 are shown in Table R.2.

Table R.2. Mission details for missions 143 (JC166-028) and 144 (JC166-034) photographic surveys.

Station ID	Dive	Date	Time (GMT)	Area (km ²)	N images	N useful images (< 6 m altitude)	Practical use
JC166-028	3	27-28/06/2018	23:11-01:51	3.9	9,611	no navigational data	Qualitative
JC166-028	5	27-28/06/2018	09:05-14:23	3.9	18,280	13,069	Quantitative
JC166-034	1	29-30/06/2018	21:21-01:22	3.9	15,268	12,378	Quantitative

For initial study, the raw format images recorded were batch converted to jpeg images at 100% image quality and with automatic colour correction using IrfanView (V 4.33) software. Overall, seafloor photographs were of good quality for both substratum type characterisation and megafauna specimen identification. A minority of those photographs were somewhat degraded by particle backscatter in the near-bottom water (particularly >3.5 m AUV altitude); however, they are of good quality for seabed characterisation. Selected examples of the substratum types and benthic invertebrates and demersal fish encountered during *Autosub6000* mission 143 dive 5 (day-time) and mission 144 dive 1 (night-time) are shown in Fig. R.7 and R.8. Examples of anthropogenic litter are shown in Fig. R.9.

Visual classification of the seabed revealed the presence of mobile sediment, including fine sands to coarser sands with pebbles and cobbles (Fig. R.7 images 1-4) and hard substrata under the form of bedrock outcrop (5) and rocks to boulders of varying size (6). Across the survey area, several patches of hard substratum were observed embedded in the sediment, offering mosaic habitat types.

The invertebrate megafauna comprised several species of annelids (Fig. R.8 images 1-3) including the 'coral worm' *Salmacina dysteri* (2); bryozoans (3-7) including the 'Ross coral' *Pentapora foliacea* (6); arthropods (8-12) including hermit crabs *Paguridae* spp. (8), squat lobsters *Munida* spp. (9), swimming crabs *Liocarcinus* spp. (11), and stone crabs *Lithodes maja* (image 12); anthozoans (anemones: Actinaria; Zoanthidea; Ceriantharia; images 13-24; soft corals: Alcyonacea; 25); asteroids (26-33) including *Porania pulvillus*, *Luidia ciliaris*, *Luidia sarsi*, *Stichastrella* sp., *Crossaster papposus*, *Marthasterias glacialis*, *Astropecten* sp.; holothuroids (34-35); ophiuroids (36-37) including *Ophiothrix fragilis*, *Ophiura* spp.; crinoids (38) including *Antedon* spp.; echinoids (39-40) including *Echinus esculentus*; octopus (41) including the curled octopus *Eledone cirrhosa*; bivalves (42-43) including the fan mussel *Atrina fragilis* (image 42); sponge (44-53) including *Polymastia* spp., *Suberites* spp., cup sponge, branching and encrusting sponge. Several species of demersal fishes were observed (54-64) including the small-spotted catshark *Scyliorhinus canicula*, rockling *Gaidropsarus vulgaris*, megrim *Lepidorhombus whiffiagonis*, and thickback sole *Microchirus variegatus* (25-30).

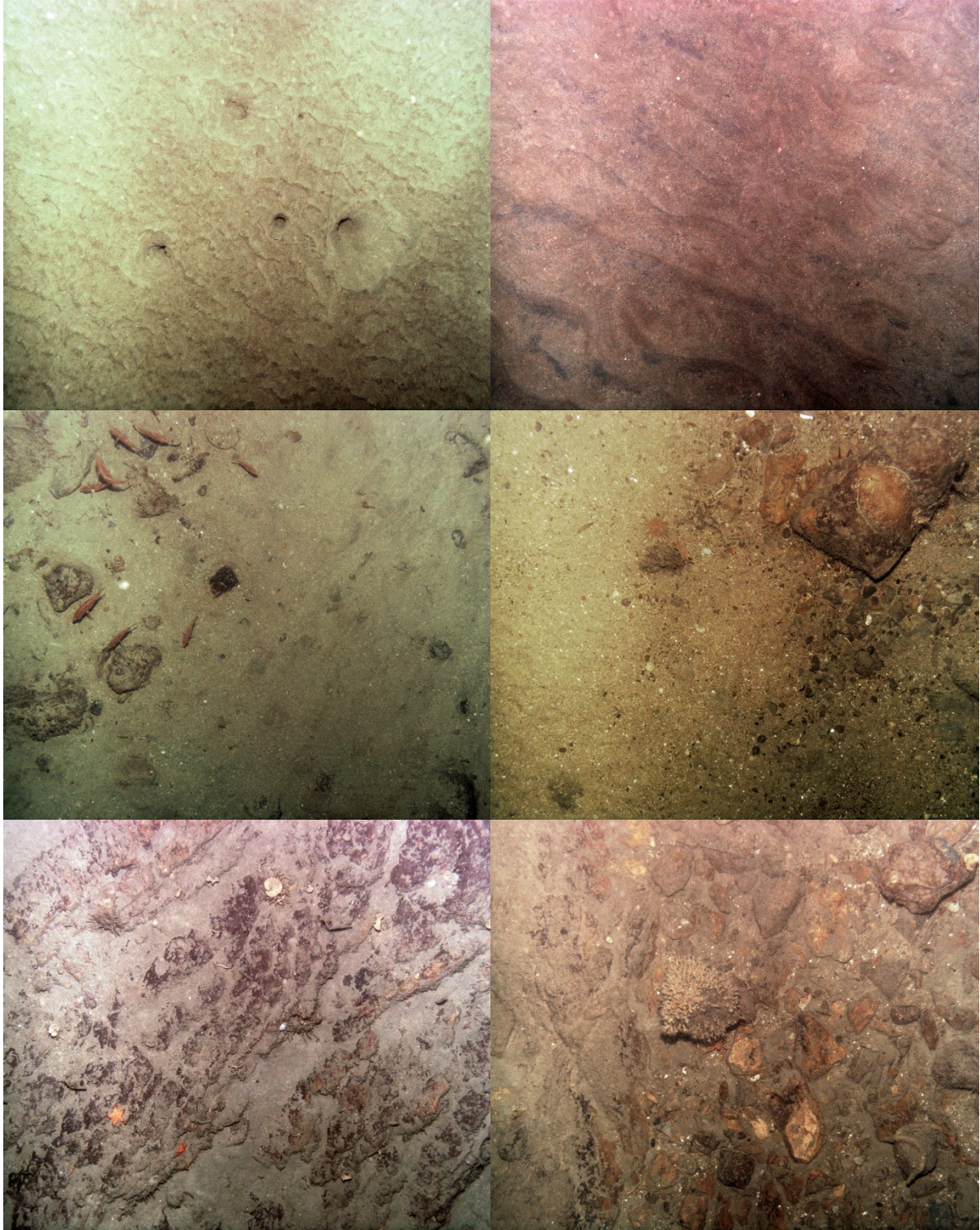

Fig. R.7. Selected examples of substratum types observed during Autosub6000 missions 143 and 144.

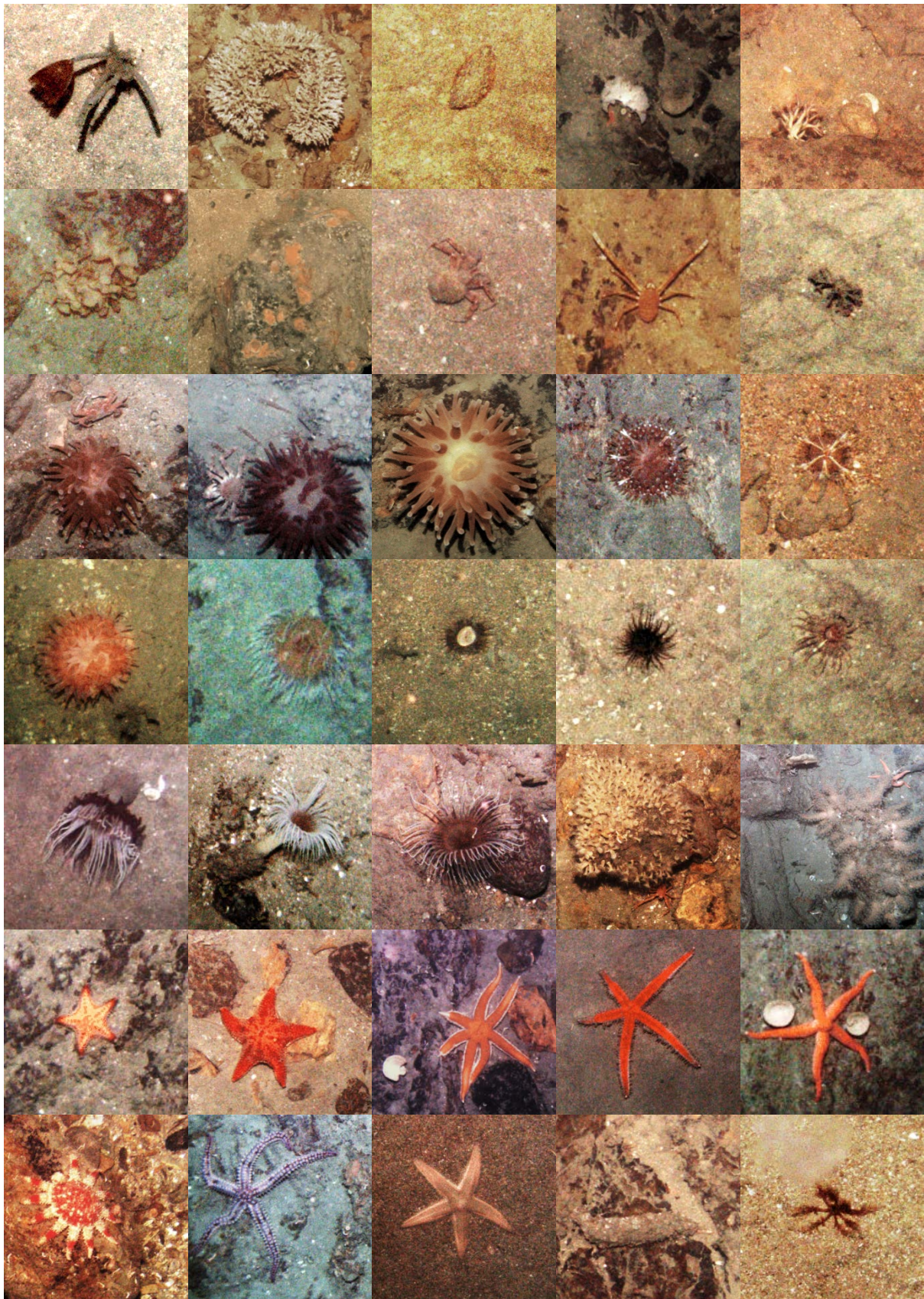

Fig. R.8 (1/2). Selected examples of the benthic invertebrates and demersal fish encountered during Autosub6000 missions 143 and 144.

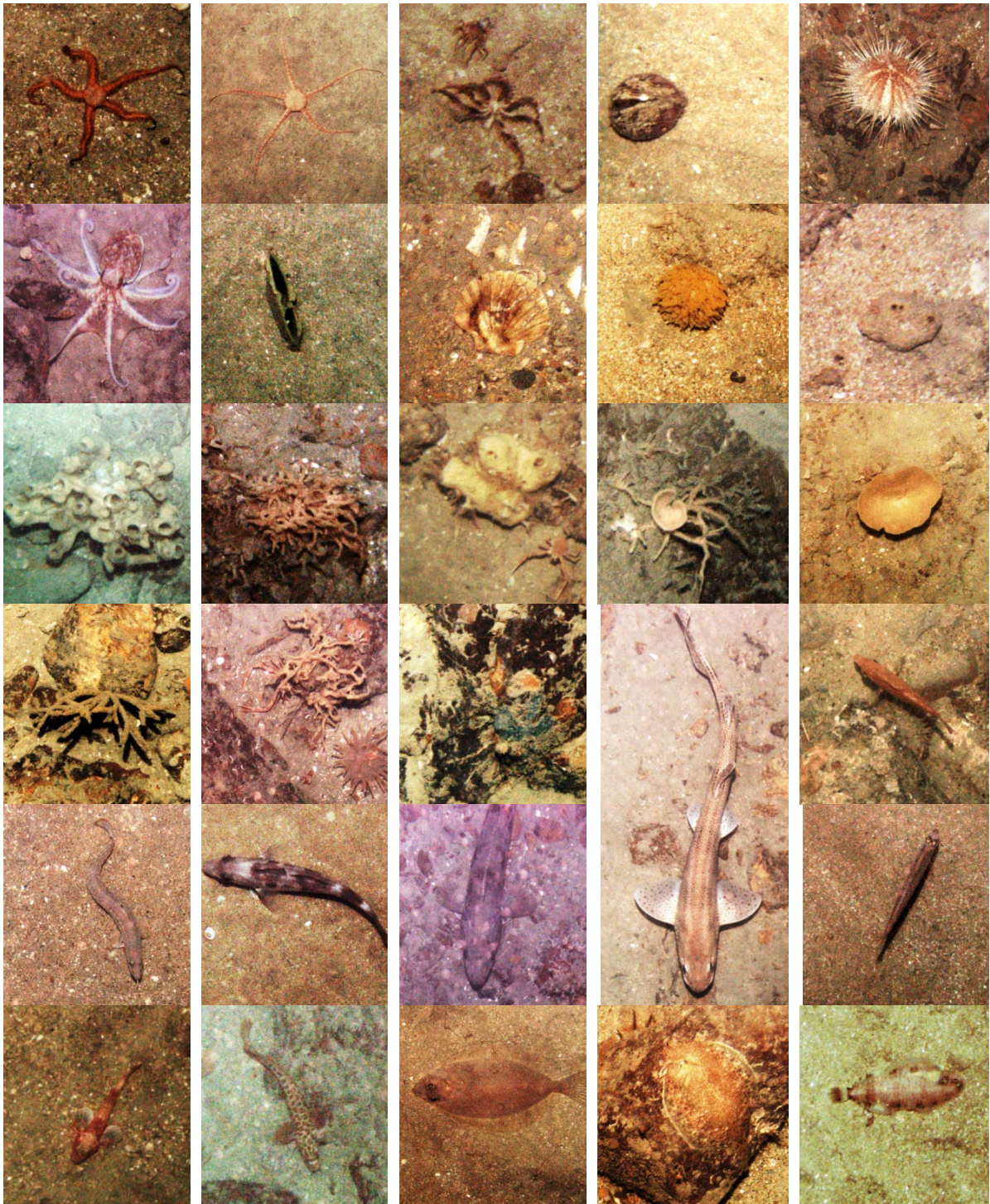

Fig. R.78(2/2). Selected examples of the benthic invertebrates and demersal fish encountered during Autosub6000 missions 143 and 144.

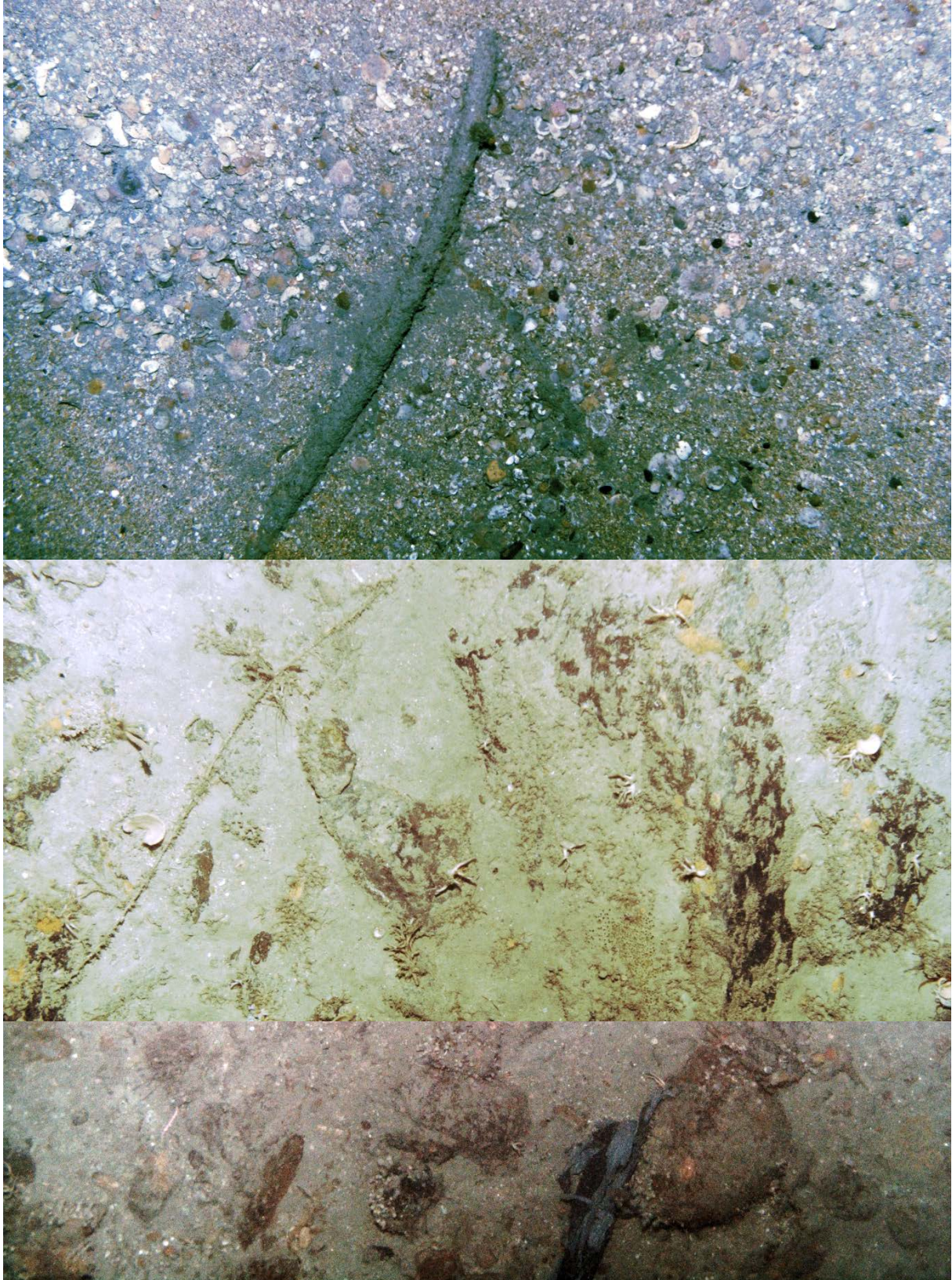

Fig. R.9. Selected examples of anthropogenic litter (fishing gear, plastic bag) encountered during Autosub6000 missions 143 and 144.

1.3. Video surveys in the Haig Fras Special Area of Conservation

Four video transects were carried out in the Haig Fras SAC, focussing on the rocky outcrops that could not be surveyed by Autosub. The locations were identified by JNCC, and included repeat transects of the transects surveyed with *Isis* during JC124 in 2015. The general transect scheme consisted of two parallel lines, one at the base of the outcrop, and one on the top. As a result of time constraints, not all of those transects could be completed in full.

1.3.1. HyBIS

Two stations were visited with HyBIS (HyBIS Tows 28 and 29), example photographs are presented in Figs. R.10 & R.11.



Fig R.10 Sample images from HyBis Tow 28 at Haig Fras (Station JC166-005)



Fig R.11 Sample images from HyBis Tow 29 at Haig Fras (Station JC166-007)

1.3.2. Isis

Two more transects were carried out later during the cruise, using the ROV *Isis* (Dives 341 and 342) in the configuration as discussed in section 10. Example photographs are shown in Figs. R.12 and R.13.

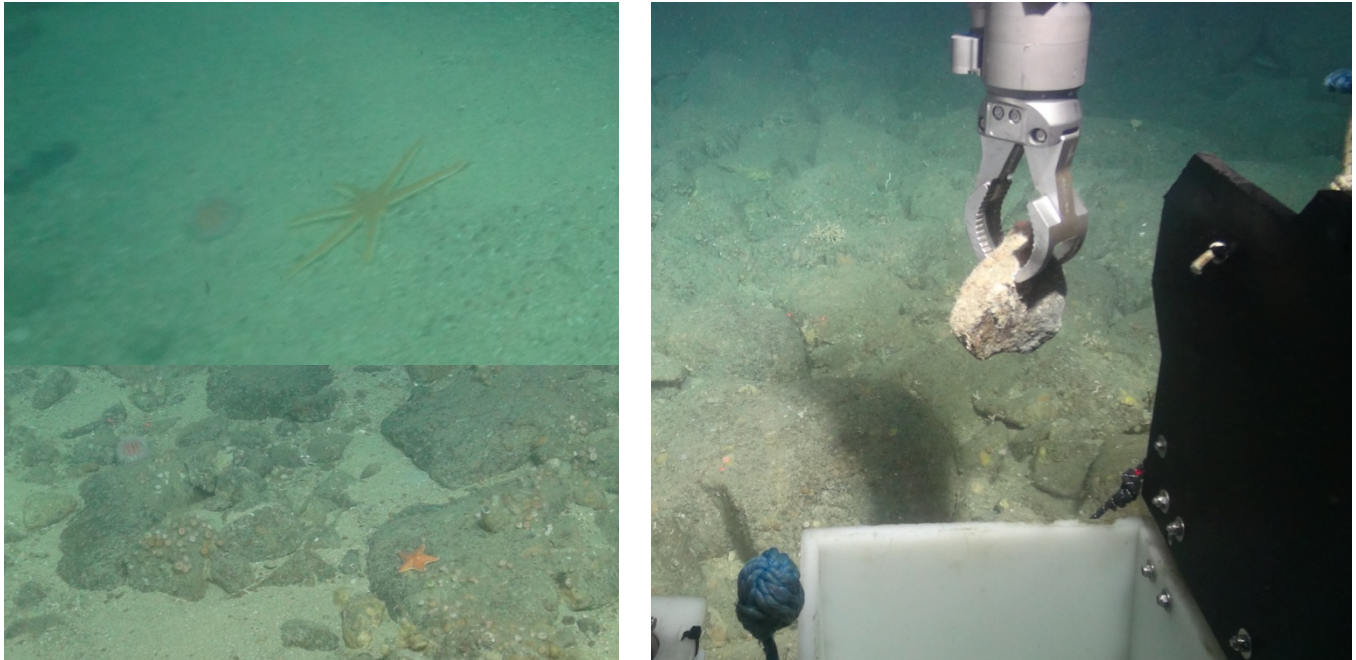

Fig R.12 Sample images from Isis Dive 341 at Haig Fras (Station JC166-030).



Fig R.13 Sample images from Isis Dive 342 at Haig Fras (Station JC166-033)

REFERENCES

- 92/43/EEC (1992) Council Directive 92/43/EEC of 21 May 1992 on the conservation of natural habitats and of wild fauna and flora.
- Amaro T, Huvenne VAI, Allcock AL, Aslam T, Davies JS, Danovaro R, de Stigter HC, Duineveld GCA, Gambi C, Gooday AJ, Gunton LM, Hall R, Howell KL, Ingels J, Kiriakoulakis K, Kershaw CE, Lavaleye MSS, Robert K, Stewart H, Van Rooij D, White M, Wilson AM (2016) The Whittard Canyon - a case study of submarine canyon processes. *Progress in Oceanography* 146:38-57 doi:10.1016/j.pocean.2016.06.003
- Benoist, N.M.A., Morris, K.J., Bett, B.J., Durden, J.M., Huvenne, V.A.I., Le Bas, T.P., Wynn, R.B., Ware, S.J., Ruhl, H.A., revised submission [May 2018]. Monitoring multiple biotopes in a marine conservation zone by autonomous underwater vehicle. *Conservation Biology*.
- Davies AJ, Roberts JM, Hall-Spencer J (2007) Preserving deep-sea natural heritage: emerging issues in offshore conservation and management. *Biol Conserv* 138:299-312 doi: 10.1016/j.biocon.2007.05.011
- De Leo FC, Smith CR, Rowden AA, Bowden DA, Clark MR (2010) Submarine canyons: hotspots of benthic biomass and productivity in the deep sea. *Proc R Soc B-Biol Sci* 277(1695):2783-2792 doi: 10.1098/rspb.2010.0462
- De Leo FC, Vetter EW, Smith CR, Rowden AA, McGranaghan M (2014) Spatial scale-dependent habitat heterogeneity influences submarine canyon macrofaunal abundance and diversity off the Main and Northwest Hawaiian Islands. *Deep-Sea Research II* 104:267-290 doi:10.1016/j.dsr2.2013.06.015
- Elith J, Leathwick JR (2009) Species distribution models: ecological explanation and prediction across space and time. *Annu Rev Ecol Syst* 40:677-697 doi:10.1146/annurev.ecolsyst.110308.120159
- Fernandez-Arcaya U, Ramirez-Llodra E, Allcock AL, Davies JS, Dissanayake A, Harris P, Howell K, Huvenne VAI, Macmillan-Lawler M, Martin J, Menot L, Nizinski M, Puig P, Rowden AA, Sanchez F, Van den Beld IM (2017) Ecological role of submarine canyons and need for canyon conservation: a review. *Frontiers in Marine Science* 4:5 doi:10.3389/fmars.2017.00005
- GEBCO (2003) GEBCO Digital Atlas : Centenary edition of the IOC/IHO General Bathymetric Chart of the Oceans. In, vol. British Oceanographic Data Centre, Liverpool
- Guisan A, Zimmermann NE (2000) Predictive habitat distribution models in ecology. *Ecological Modelling* 135:147-186 doi:10.1016/S0304-3800(00)00354-9
- Gunton LM, Gooday AJ, Glover AG, Bett BJ (2015) Macrofaunal abundance and community composition at lower bathyal depths in different branches of the Whittard Canyon and on the adjacent slope (3500 m; NE Atlantic). *Deep Sea Research I* 97:29-39 doi:10.1016/j.dsr.2014.11.010
- Hall RA, Aslam T, Huvenne VAI (2017) Partly standing internal tides in a dendritic submarine canyon observed by an ocean glider. *Deep Sea Research I* 126:73-84 doi:10.1016/j.dsr.2017.05.015
- Huvenne VAI, Davies JS (2014) Towards a new and integrated approach to submarine canyon research. *Deep-Sea research II* 104:1-5 doi:10.1016/j.dsr2.2013.09.012

- Huvenne VAI, Tyler PA, Masson DG, Fisher EH, Hauton C, Hühnerbach V, Le Bas TP, Wolff GA (2011) A picture on the wall: innovative mapping reveals cold-water coral refuge in submarine canyon. PLoS One 6(12):e28755 doi: 10.1371/journal.pone.0028755
- Huvenne, V.A.I., Wynn, R.B & Gales, J. 2016. RRS James Cook Cruise 124-125-126, 09 Aug - 12 Sept, CODEMAP2015 Habitat mapping and ROV vibrocorer trials around Whittard Canyon and Haig Fras. p. 223.
- Johnson MP, White M, Wilson A, Würzberg L, Schwabe E, Folch H, Allcock L (2013) A vertical wall dominated by *Acesta excavata* and *Neopycnodonte zibrowii*, part of an undersampled group of deep-sea habitats. PLoS One 8(11):e79917 doi:10.1371/journal.pone.0079917
- OSPAR (2008) OSPAR list of threatened and/or declining species and habitats.
- Pierdomenico M, Martorelli E, Dominguez-Carrio C, Gili J-M, Chiocci FL (2016) Seafloor characterization and benthic megafaunal distribution of an active submarine canyon and surrounding sectors: the case of Gioia Canyon (Southern Tyrrhenian Sea). Journal of Marine Systems 157:101-117 doi:10.1016/j.marsys.2016.01.005
- Robert K, Jones DOB, Tyler PA, Van Rooij D, Huvenne VAI (2015) Finding the hotspots within a biodiversity hotspot: fine-scale biological predictions within a submarine canyon using high-resolution acoustic mapping techniques. Marine Ecology 36:1256-1276 doi:10.1111/maec.12228
- Ruhl, H.A., 2013. RRS Discovery Cruise 377 & 378, 05 - 27 Jul 2012, Southampton to Southampton. Autonomous ecological surveying of the abyss: understanding mesoscale spatical heterogeneity at the Porcupine Abyssal Plain. (National Oceanography Centre Cruise report, No. 23). p. 73.
- Vetter EW, Smith CR, De Leo FC (2010) Hawaiian hotspots: enhanced megafaunal abundance and diversity in submarine canyons on the oceanic islands of Hawaii. Marine Ecology 31:183-199 doi:10.1111/j.1439-0485.2009.00351.x
- Wynn, R. B., B. J. Bett, A. J. Evans, G. Griffiths, V. A. I. Huvenne, A. R. Jones, M. R. Palmer, D. Dove, J. A. Howe, T. J. Boyd and MAREMAP partners (2012). Investigating the feasibility of utilizing AUV and Glider technology for mapping and monitoring of the UK MPA network. Final report for Defra project MB0118. National Oceanography Centre, Southampton: 224.

STATION LIST

Site	Final sample number	JDay	Start Time	Start			Start Deg	Start Min	Start Long	Start Water depth	JD	End Date	GMT	End Lat	End Long	End water depth	Comments	Recipient
				Lat	Long	mete												
Haig Fras	JC166-001-SVP01/SVP01	171	20/06/2018 17:09:00	50 23.9545	7 43.0942	110	171	20/06/2018 17:19:00	50 23.9547	7 43.0940	110	Attached to HyBis						
Haig Fras	JC166-002-MBES01/EM710	171	20/06/2018 21:10:00	50 18.7370	7 43.2900	105	171	20/06/2018 22:34:00	50 18.8174	7 44.5748	106	Patch test.						
Haig Fras	JC166-003-MBES02/EM710	171	20/06/2018 23:04:00	50 20.1127	7 44.3211	109	172	21/06/2018 09:44:00	50 23.8800	7 46.3380	110							
Haig Fras	JC166-004-MBES03/EM710	172	21/06/2018 16:44:00	50 24.6540	7 46.9200	110	172	21/06/2018 17:57:00	50 15.2174	7 46.6566	77							
Haig Fras	JC166-005-Hy28/HY28	172	21/06/2018 18:53:00	50 14.1549	7 55.5972	80	172	21/06/2018 19:50:00	50 14.1882	7 55.4822	86	Coordinates are ship's position.						
Haig Fras	JC166-006-MBES04/EM710	172	21/06/2018 20:42:00	50 14.7859	7 46.9497	95	173	22/06/2018 07:36:00	50 10.6840	7 46.1680	89	Infill liner completed.						
Haig Fras	JC166-007-Hy29/HY29	173	22/06/2018 08:58:00	50 10.9000	7 46.4300	80	173	22/06/2018 11:38:00	50 10.7600	7 46.1000	97	0.2 knot vessel speed.						
Haig Fras	JC166-008-MBES05/EM710	173	22/06/2018 13:30:00	50 14.6280	7 50.3160	90	173	22/06/2018 21:32:00	50 19.8480	7 50.3160	92							
Haig Fras	JC166-009-MBES06/EM710	173	22/06/2018 21:32:00	50 19.8480	7 50.3160	92	174	23/06/2018 10:42:00	48 30.5580	9 36.0960	650	Transit Haig Fras-Whittard Canyon.						
Whittard Canyon	JC166-010-MBES07/EM120	174	23/06/2018 10:44:00	49 30.6480	9 35.9400	625	174	23/06/2018 15:21:00	47 53.0891	10 10.7631	4040	Transit Haig Fras-Whittard Canyon.						
Whittard Canyon	JC166-011-DeepGlider01/Dglider01	174	23/06/2018 15:21:00	47 53.0891	10 10.7631	4040	184	03/07/2018 05:41:00	47 48.5472	10 9.8020	4112							
Whittard Canyon	JC166-012-SVP02/SVP02	174	23/06/2018 16:31:00	47 55.2027	10 10.8046	3987	174	23/06/2018 20:47:00	47 55.2029	10 10.8057	3991	Attached to ROV ISIS weight beam. Max cable deployed 3902 m. Held cable deployment at 3900 m for 60 min.						
Whittard Canyon	JC166-013-MBES08/EM120	174	23/06/2018 23:02:00	47 55.5970	10 10.1659	3999	175	24/06/2018 02:11:00	47 58.0350	10 13.8991	3961							
Whittard Canyon	JC166-014-MBES09/EM120	175	24/06/2018 02:54:00	47 59.3190	10 13.5500	3956	175	24/06/2018 08:00:00	47 55.5280	10 11.9280	4005							
Whittard Canyon	JC166-015-ALRech01/ALRech01	175	24/06/2018 13:07:00	47 55.1920	10 10.8700	4005	175	24/06/2018 15:28:00	47 55.1924	10 10.8568	4004	Data were not recorded.						
Whittard Canyon	JC166-016-MBES10/EM120	175	24/06/2018 15:53:00	47 55.2100	10 10.7700	4010	175	24/06/2018 17:13:00	48 4.3562	10 0.3556	2935	Test deployment to 20 m. Problems detected with ALR.						
Whittard Canyon	JC166-017-ALRech02/ALRech02	175	24/06/2018 17:20:00	48 4.3626	10 0.3483	2935	175	24/06/2018 17:27:00	48 4.3626	10 0.3483	2935							
Whittard Canyon	JC166-018-MBES11/EM120	175	24/06/2018 17:43:00	48 4.4048	10 0.2710	2912	175	24/06/2018 10:04:48	48 16.0938	9 43.9680	610							
Whittard Canyon	JC166-019-MBES12/EM710	175	24/06/2018 19:43:00	48 16.1961	9 44.0653	614	175	24/06/2018 22:26:00	48 41.2282	9 38.4071	174	In transit at 10 knots to waypoint. Includes transit to WP33. Some gaps in transit due to areas of deep water (inter flume?). Did not switch to EM710 for these short patches.						
Whittard Canyon	JC166-020-MBES13/EM710	175	24/06/2018 22:26:00	48 41.2282	9 38.4071	174	176	25/06/2018 07:54:00	48 16.9617	9 39.3780	371							
Whittard Canyon	JC166-021-ISIS340/ISIS340	176	25/06/2018 13:10:00	48 16.8996	9 39.6046	372	176	25/06/2018 19:35:00	48 16.5790	9 39.0290	355							
Whittard Canyon	JC166-021-ISIS340/PSH01	176	25/06/2018 14:41:00	48 16.9000	9 39.5500	378						Good core.	Tab					
Whittard Canyon	JC166-021-ISIS340/PSH02	176	25/06/2018 14:43:00	48 16.9000	9 39.5500	378						Good core.	Tab					
Whittard Canyon	JC166-021-ISIS340/TBE01	176	25/06/2018 15:23:00	48 16.8500	9 39.4000	369						Coral fragments.	Tab					
Whittard Canyon	JC166-021-ISIS340/SLP01	176	25/06/2018 15:46:00	48 16.8400	9 39.3500	359						Holothurian x1 (<i>Parastichopus</i> ?)	Rob Young (NOCs)					
Whittard Canyon	JC166-021-ISIS340/BI0B01	176	25/06/2018 16:31:00	48 16.8100	9 39.2380	359						Cup coral x1. Anemones x3 including a yellow one.	Tab					
Whittard Canyon	JC166-021-ISIS340/PSH03	176	25/06/2018 16:43:00	48 16.8100	9 39.2380	363						Good core.	Tab					
Whittard Canyon	JC166-021-ISIS340/PSH04	176	25/06/2018 16:45:00	48 16.8100	9 39.2380	363						Good core (c. 10 cm sediment).	Tab					
Whittard Canyon	JC166-021-ISIS340/TBE02	176	25/06/2018 17:05:00	48 16.7840	9 39.2330	361						Coral fragments (3 scoops). Squat lobster.	Tab					
Whittard Canyon	JC166-021-ISIS340/PSH05	176	25/06/2018 18:03:00	48 16.6320	9 39.1010	361						Sample may have fallen out.	Tab					
Whittard Canyon	JC166-021-ISIS340/PSH06	176	25/06/2018 18:04:00	48 16.6320	9 39.1010	361						Good core.	Tab					
Whittard Canyon	JC166-021-ISIS340/TBE03	176	25/06/2018 18:12:00	48 16.6320	9 39.1010	361						Coral fragments (large pieces).	Tab					
Whittard Canyon	JC166-021-ISIS340/TBE04	176	25/06/2018 18:29:00	48 16.6280	9 39.0950	360						Anemone x1. Cup coral x1.	Tab					
Whittard Canyon	JC166-021-ISIS340/TBE05	176	25/06/2018 18:38:00	48 16.6280	9 39.0950	360						Fossil corals (?) seem to have have fallen out.	Tab					
Whittard Canyon	JC166-021-ISIS340/BI0B02	176	25/06/2018 18:43:00	48 16.6280	9 39.0950	360						Anemone x1 attached to rock.	Tab					
Whittard Canyon	JC166-021-ISIS340/TBE06	176	25/06/2018 18:56:00	48 16.6190	9 39.0860	359						Cup coral on fossil coral.	Tab					
Whittard Canyon	JC166-022-ALRech03/ALRech03	176	25/06/2018 14:01:00	48 16.9419	9 39.7348	385	176	25/06/2018 14:15:00	48 16.9312	9 39.7114	385	Test deployment to 10 m. No data recorded.						
Whittard Canyon	JC166-023-MBES14/EM710	176	25/06/2018 19:57:00	48 16.7490	9 39.7348	350	177	26/06/2018 07:42:00	48 26.1100	9 38.1500	343	Transit to start of line 6. Changed to Whittard Canyon SVP @21:40 10 knots. Started line 6 @22:34 8 knots. Stopped midway point of line 10 due to time. Filled in missing data then transitioned to WP36.						

Site	Final sample number	JDay (Start)	Start Date	Start Time GMT	Start	Start	Start	Start	Start Waterd epth meter	JDay	End Date	End Time GMT	End	End	End	Comments	Recipient
					Lat Degr	Lat N	Long W	Long Min W					Lat Degr	End Lat	End Long		
Whittard Canyon	JC166-024-AUV142/ASubM142	177	26/06/2018	11:26:00	48 26.0087	9 37.7184			301	177	26/06/2018	17:52:00	48 25.8260	9 38.2940	332	No navigation data recorded. No seafloor images recorded, just water column. Sidescan data collected, AUV successfully deployed and recovered.	
Whittard Canyon	JC166-025-MBES15/EM710	177	26/06/2018	20:25:00	48 26.1955	9 37.8738			329	178	27/06/2018	10:47:00	50 22.4770	7 41.4740	100	Transit Whittard Canyon-Haig Fras (WP 01). SVP yellow flag noticed at line 137 @02:52. Start Time GMT and Coordinates correspond to deployment.	
Haig Fras	JC166-026-WaveGlider01/Wglider01	178	27/06/2018	11:00:00	50 22.4781	7 41.4685			103	178	27/06/2018	16:00:00	50 22.7539	7 42.8220	106		
Haig Fras	JC166-027-ALRech04/ALRech04	178	27/06/2018	13:28:00	50 22.8632	7 43.0134			105	178	27/06/2018	14:32:00	50 22.8290	7 43.0140	105		
Haig Fras	JC166-028-AUV143/ASubM143	178	27/06/2018	17:17:00	50 24.0670	7 42.5140			105	179	28/06/2018	16:22:00	50 23.9500	7 42.4450	111	Photo and navigation data not collected before 3:50 surface due to failure.	
Haig Fras	JC166-029-SVP03/SVP03	179	28/06/2018	12:48:00	50 22.4200	7 42.5700			103	179	28/06/2018	13:00:00	50 22.4200	7 42.5700	103		
Haig Fras	JC166-030-ISIS341/ISIS341	179	28/06/2018	16:54:00	50 21.5300	7 36.4380			81	179	28/06/2018	21:29:00	50 21.3750	7 36.3910	99		
Haig Fras	JC166-030-ISIS341/BIOB01	179	28/06/2018	18:24:00	50 21.6120	7 36.4400			85							Cup sponge x2.	NOC
Haig Fras	JC166-030-ISIS341/RCK01	179	28/06/2018	18:24:00	50 21.6120	7 36.4400			84							Rock with cup corals and branching hydroid <i>Nemertesia</i> ?	NOC
Haig Fras	JC166-030-ISIS341/SLP01	179	28/06/2018	18:52:00	50 21.6119	7 36.4391			84							Meant to collect a tube-dwelling anemone but it burrowed before catch.	NOC
Haig Fras	JC166-030-ISIS341/BIOB02	179	28/06/2018	19:10:00	50 21.6121	7 36.4382			84							Rock with encrusting orange bryozoan.	NOC
Haig Fras	JC166-030-ISIS341/TBE01	179	28/06/2018	19:29:00	50 21.6118	7 36.4383			84							Porella (hoovered broken pieces).	NOC
Haig Fras	JC166-031-MBES16/EM710	179	28/06/2018	22:23:00	50 23.8810	7 37.4300			105	180	29/06/2018	08:38:00	50 15.0400	7 36.5900	97		
Haig Fras	JC166-032-ASV01/ASV01	180	29/06/2018	10:42:00	50 15.0799	7 36.6303			89	180	29/06/2018	13:14:00	50 12.2563	7 41.8551	98		
Haig Fras	JC166-033-ISIS342/ISIS342	180	29/06/2018	14:55:00	50 15.1624	7 36.6037			71	180	29/06/2018	19:24:00	50 25.2790	7 60.8096	86		
Haig Fras	JC166-033-ISIS342/SLP01	180	29/06/2018	17:12:00	50 15.1017	7 36.5413			90							Yellow sponge <i>Polymastia</i> x1.	NOC
Haig Fras	JC166-033-ISIS342/SLP02	180	29/06/2018	17:48:00	50 15.1222	7 36.4855			98							Certhanthid x1.	NOC
Haig Fras	JC166-033-ISIS342/SLP03	180	29/06/2018	17:56:00	50 15.1200	7 36.4853			97							Erect grey sponge x1.	NOC
Haig Fras	JC166-033-ISIS342/BIOB01	180	29/06/2018	18:03:00	50 15.1209	7 36.4859			97							Rock (c. 12 cm) with anemones.	NOC
Haig Fras	JC166-033-ISIS342/SLP04	180	29/06/2018	18:26:00	50 15.1550	7 36.4940			97							Large anemone x1 on rock.	NOC
Haig Fras	JC166-033-ISIS342/SLP05	180	29/06/2018	19:02:00	50 15.1940	7 36.4990			87							Starfish <i>Stichastrella</i> x1.	NOC
Haig Fras	JC166-034-AUV144/ASubM144	180	29/06/2018	21:24:00	50 24.0218	7 42.8786			111	181	30/06/2018	10:22:00	50 23.3851	7 43.3612	181	USBL beacon not detected from vessel when AUV runs distant lines.	
Haig Fras	JC166-035-MBES17/EM710	181	30/06/2018	10:39:00	50 21.7414	7 44.7000			107	182	01/07/2018	00:16:00	48 28.3832	9 43.4015	460	Transit Haig Fras-Whittard Canyon, WP45. Log started during transit when switched from EM710 to EM120. Logged transit lines and then headed to WP45. End time/coordinates/depth for WP45.	
Whittard Canyon	JC166-036-MBES18/EM120	182	01/07/2018	00:17:00	48 28.3832	9 43.4015			580	182	01/07/2018	08:18:00	48 20.7780	9 49.5039	1621	Aim depth 1500 m. Stop for 5 min to record data at 50, 200, 500, 1000, and 1500 m water depth.	
Whittard Canyon	JC166-037-ALRech05/ALRech05	182	01/07/2018	16:02:00	48 20.8332	9 49.4414			1602	182	01/07/2018	11:02:00	48 20.8325	9 49.4418	1600		
Whittard Canyon	JC166-038-ALRech06/ALRech06	182	01/07/2018	13:04:00	48 23.1500	10 0.8500			3046	182	01/07/2018	15:13:00	48 23.1500	10 0.8500	3046		
Whittard Canyon	JC166-039-MBES19/EM120	182	01/07/2018	15:43:00	48 22.9615	10 1.4383			3075	182	01/07/2018	19:45:00	48 26.8074	9 50.7785	353	Stop logging data when switched from EM120 to EM710.	
Whittard Canyon	JC166-040-MBES20/EM710	182	01/07/2018	19:46:00	48 28.9116	9 50.6841			343	183	02/07/2018	06:36:00	48 29.5800	9 38.7400	865	Switched to EM120 during transit, ended this station at this point	
Whittard Canyon	JC166-041-MBES21/EM120	183	02/07/2018	06:38:00	48 29.5800	9 38.9400			865	183	02/07/2018	07:57:00	48 27.1400	9 48.9500	816	Switched to EM710 during transit, ended this station at this point	
Whittard Canyon	JC166-042-MBES22/EM710	183	02/07/2018	07:59:00	48 27.1400	9 48.9500			800	183	02/07/2018	08:28:00	48 30.5300	9 51.0389	611	Arrived at WP46.	
Whittard Canyon	JC166-043-ISIS343/ISIS343	183	02/07/2018	09:42:00	48 30.4327	9 51.1159			619	183	02/07/2018	15:46:00	48 30.2370	9 50.5316	440		
Whittard Canyon	JC166-043-ISIS343/BIOB01	183	02/07/2018	11:35:00	48 30.5593	9 51.0820			712							Event 01 was initially an attempt for push core (soft sand) that failed (some sand failed in the green tube). It is now an accidental collection of coral.	NOC & Michelle Taylor
Whittard Canyon	JC166-043-ISIS343/SLP01	183	02/07/2018	12:32:00	48 30.4800	9 50.8912			521							Holothurian x3.	Rob Young (NOCs)
Whittard Canyon	JC166-043-ISIS343/PSH01	183	02/07/2018	12:35:00	48 30.4800	9 50.8900			521							Sandy mud for microplastics analysis.	NOC

Site	Final sample number	JDay (Start)	Start Date	Start Time GMT	Start Lat Degr N	Start Lat Min N	Start Long Degr W	Start Long Min W	Start Water depth meter	JDay	End Date	End Time GMT	End Lat Degr	End Lat Min	End Long Degr	End Long Min	End water depth meter	Comments	Recipient
Whittard Canyon	JC166-043-ISIS343/PSH02	183	02/07/2018	12:37:00	48 30.4800		9 50.8900		520									Sandy mud for organic matter analysis.	NOC
Whittard Canyon	JC166-043-ISIS343/PSH03	183	02/07/2018	12:38:00	48 30.4800		9 50.8900		520									Sandy mud for geological analysis.	NOC
Whittard Canyon	JC166-043-ISIS343/PSH04	183	02/07/2018	14:13:00	48 30.3500		9 50.6500		447									Practice push core	NOC
Whittard Canyon	JC166-043-ISIS343/PSH05	183	02/07/2018	15:04:00	48 30.1840		9 50.5200		390									Full mud core WP098 for microplastics analysis and corals.	NOC
Whittard Canyon	JC166-043-ISIS343/PSH06	183	02/07/2018	15:06:00	48 30.1840		9 50.5200		390									Full mud core WP098 for geological analysis.	NOC
Whittard Canyon	JC166-043-ISIS343/PSH07	183	02/07/2018	15:08:00	48 30.1840		9 50.5200		390									Full mud core WP098 for organic matter analysis.	NOC
Whittard Canyon	JC166-044-MBES23/EM120	183	02/07/2018	16:24:00	48 30.3508		9 50.7417		510	183	02/07/2018	21:06:00	47 45.4738		10 8.4553		4190		
Whittard Canyon	JC166-045-MBES24/EM120	183	02/07/2018	22:22:00	47 46.3250		10 8.0770		4188	184	03/07/2018	05:30:00	47 48.7200		10 9.8470		4110		
Whittard Canyon	JC166-046-WaveGlider02/WgGlider02	184	03/07/2018	06:53:00	47 46.3170		10 8.6710		4156	185	04/07/2018	05:47:00	47 58.9650		10 11.3570		3913		
																		2 entries in the protocol file (OFOP) are out of order ('start video recording' and 'start recording'); first 2 entries appear last. May need to replace science camera due to condensation in lense + scratch. Pilot and Scorpia camera both shut down before end of dive.	
Whittard Canyon	JC166-047-ISIS344/ISIS344	184	03/07/2018	09:52:00	47 46.5735		10 5.4232		3841	184	03/07/2018	19:24:00	47 46.7990		10 5.2288		3836		
Whittard Canyon	JC166-047-ISIS344/PSH01	184	03/07/2018	15:34:00	47 46.5755		10 5.4874		3875									Half-full push core (stiff carbonate mud) for microplastics analysis.	NOC
Whittard Canyon	JC166-047-ISIS344/PSH02	184	03/07/2018	15:38:00	47 46.5755		10 5.4874		3875									2/3-full push core (stiff carbonate mud) for geological analysis. Mud on outside.	NOC
Whittard Canyon	JC166-047-ISIS344/PSH03	184	03/07/2018	15:43:00	47 46.5755		10 5.4874		3875									Half-full push core (stiff carbonate mud) for organic matter analysis.	NOC
Whittard Canyon	JC166-048-SVP04/SVP04	184	03/07/2018	20:36:00	47 46.6480		10 10.0112		4141	184	03/07/2018	22:48:00	47 46.6490		10 10.0127		4152		
Whittard Canyon	JC166-048-ALRech07/ALRech07	184	03/07/2018	20:36:00	47 46.6480		10 10.0112		4141	184	03/07/2018	22:48:00	47 46.6490		10 10.0127		4152		SVP was attached
Whittard Canyon	JC166-049-MBES49/EM120	184	03/07/2018	23:30:00	47 46.2000		10 10.2140		4182	185	04/07/2018	10:28:00	48 26.3226		9 45.3600		1222		On Site for ROV
Canyons MCZ	JC166-050-ISIS345/ISIS345	185	04/07/2018	12:27:00	48 26.4130		9 45.0745		1200	185	04/07/2018	16:55:00	48 26.7528		9 43.2439		903		OFOP protocol not made properly. See 345new text file
Canyons MCZ	JC166-050-ISIS345/PSH01	185	04/07/2018	13:54:00	48 26.3142		9 45.3540		1220									push core failed, fine sand and mud surface sediment potentially disturbed.	
Canyons MCZ	JC166-059-ISIS345/PSH02	185	04/07/2018	13:59:00	48 26.3142		9 45.3340		1220									Microplastic analysis	
Canyons MCZ	JC166-050-ISIS345/PSH03	185	04/07/2018	14:00:00	48 26.3714		9 45.3340		1220									70% full, mud, strata apparent. Geology analysis	
Canyons MCZ	JC166-050-ISIS345/PSH04	185	04/07/2018	14:11:00	48 26.3152		9 45.3540		1220									new location mud with some sand	
Canyons MCZ	JC166-050-ISIS345/BIOB01	185	04/07/2018	14:14:00	48 26.3172		9 45.3564		1219									organic carbon analysis.	

MAPS

General cruise track:

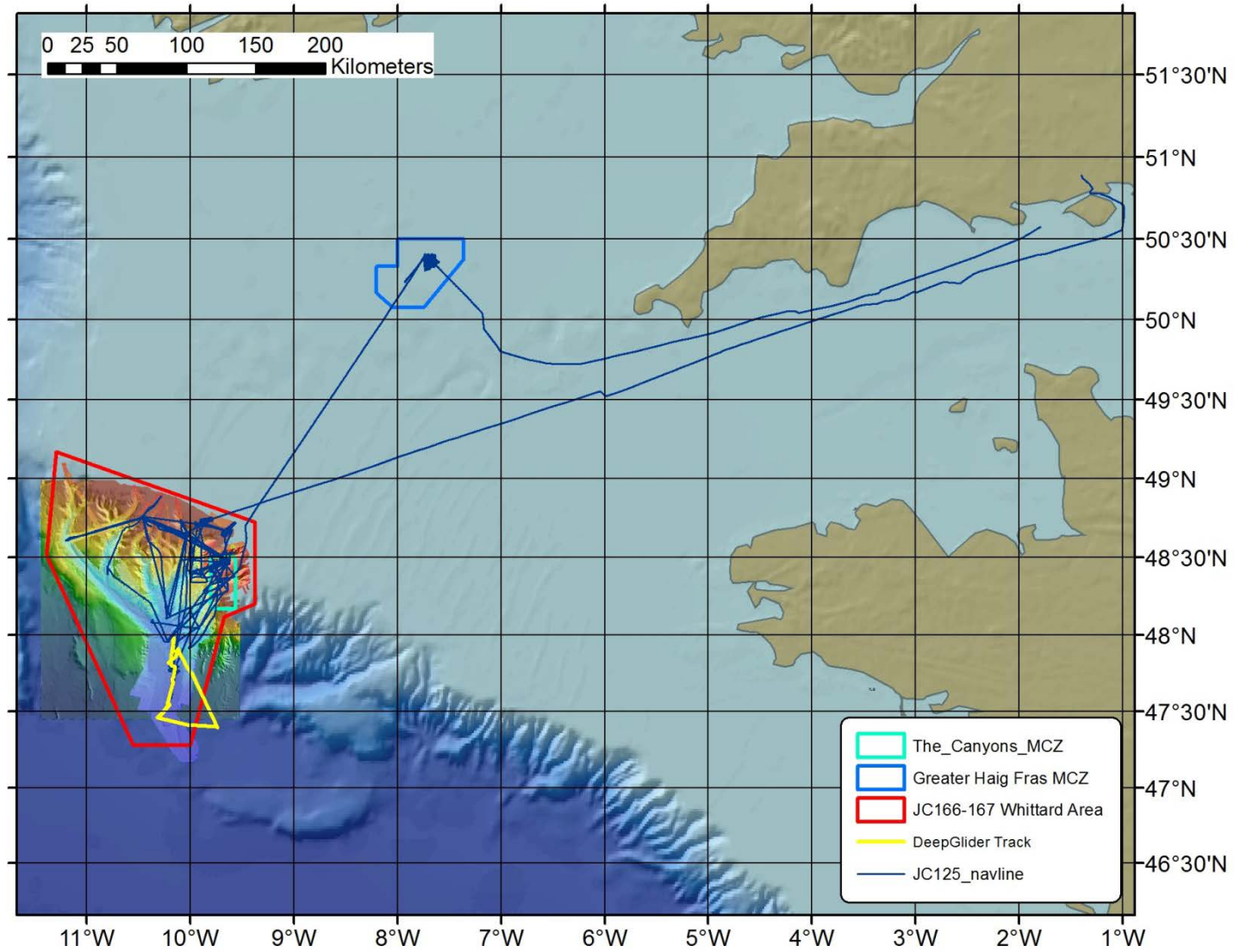

Overview of work at Haig Fras:

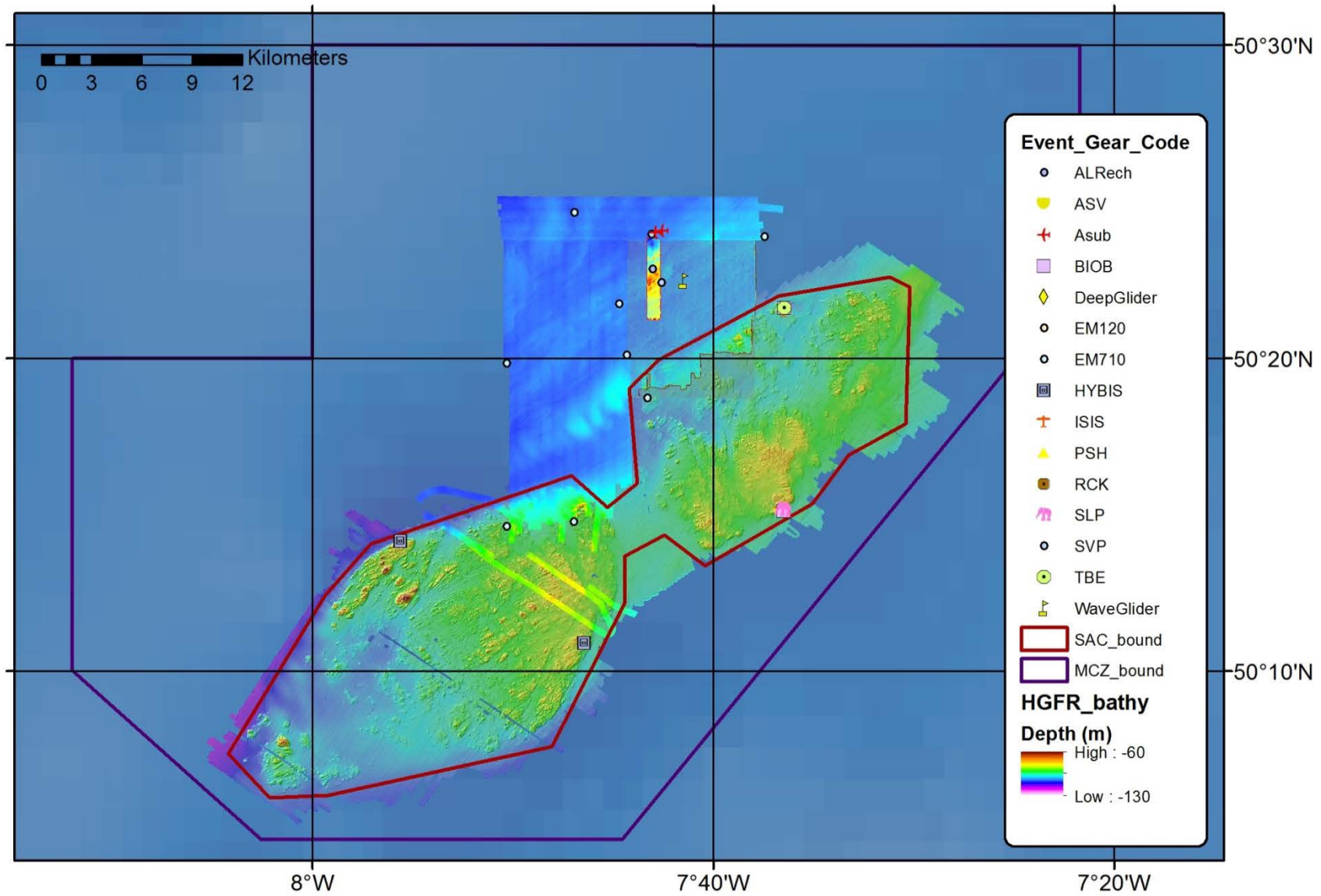

Haig Fras ISIS Dive 341:

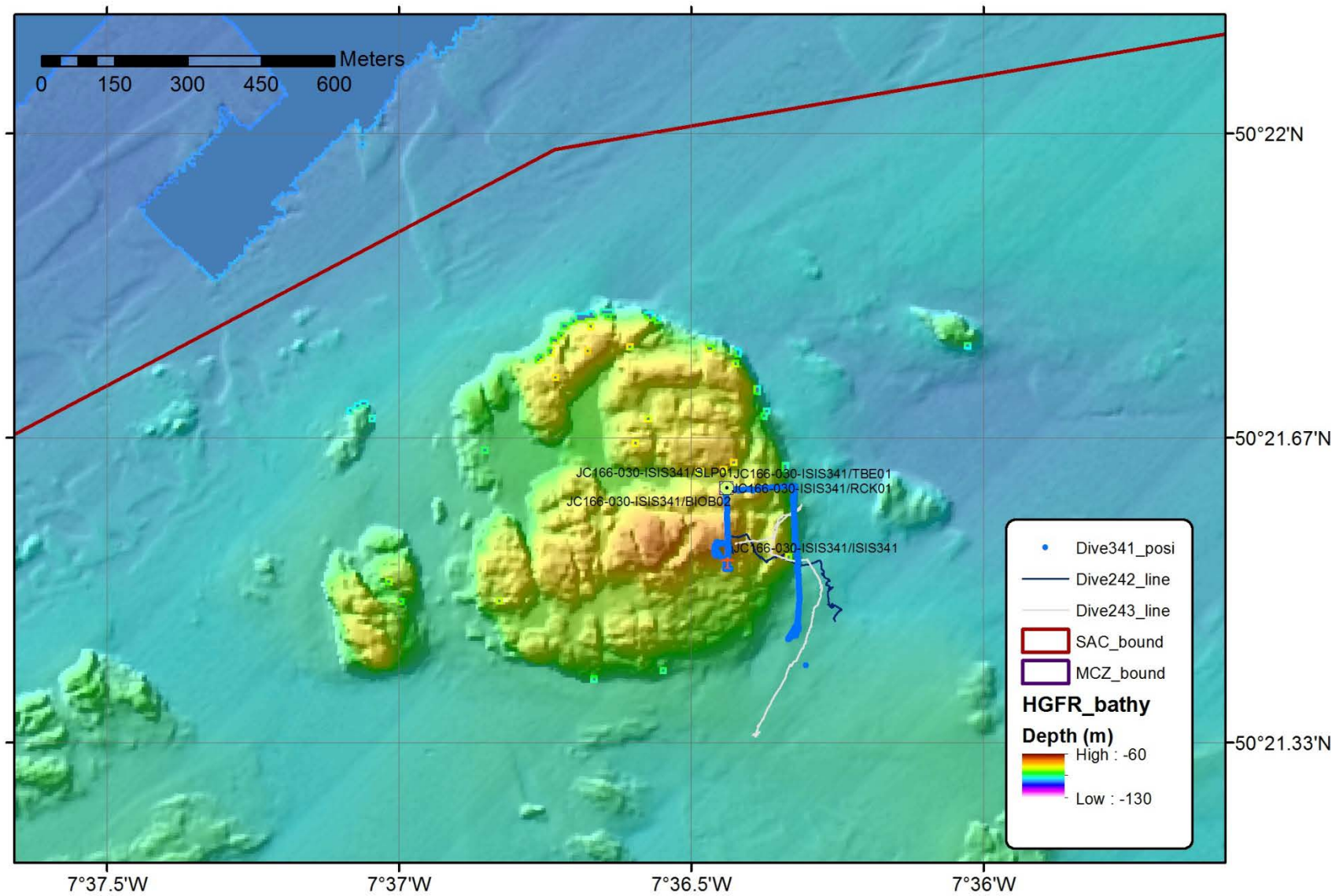

Haig Fras ISIS Dive 342:

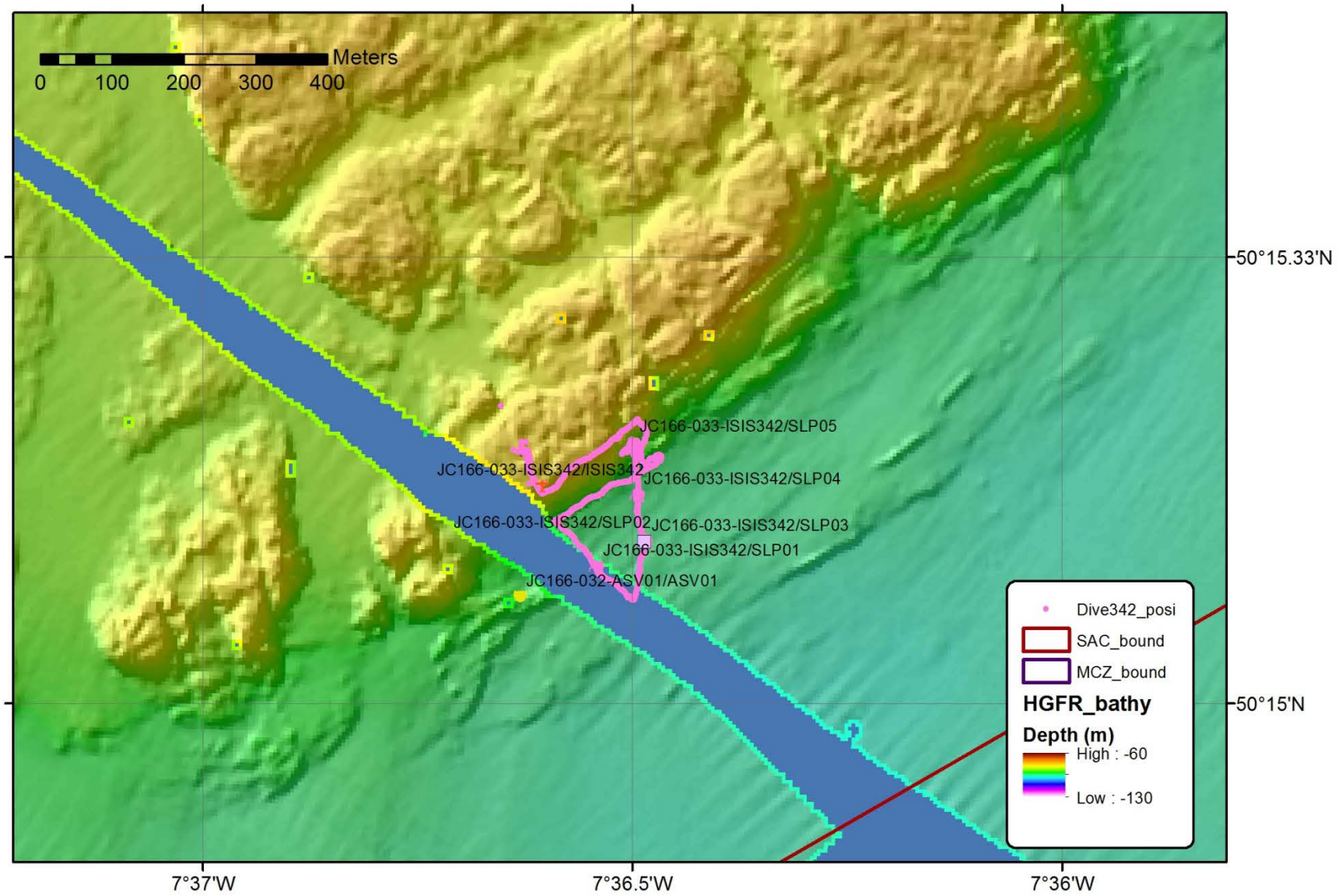

Haig Fras HyBis Tow 28:

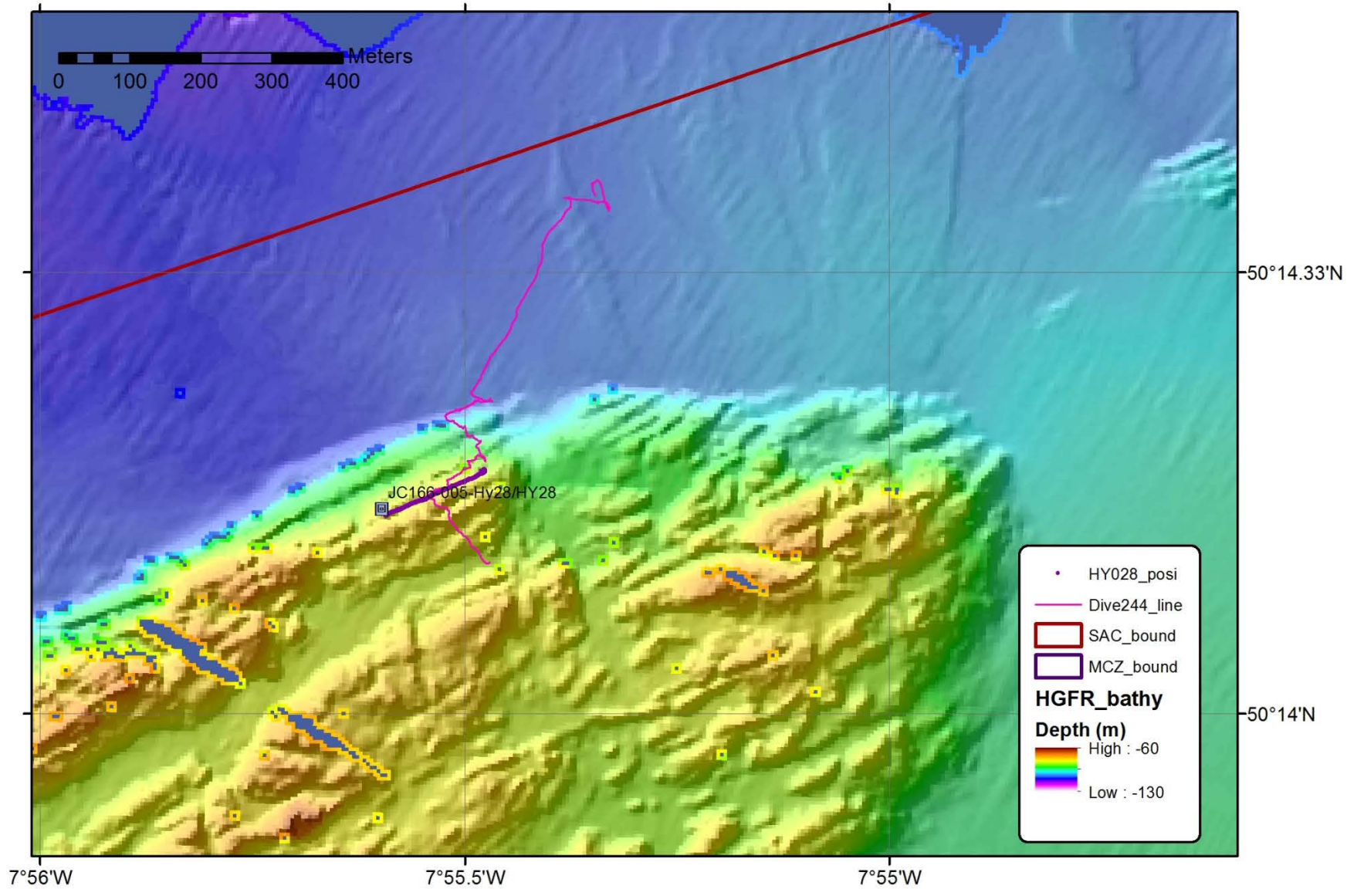

Haig Fras HyBis Tow 29:

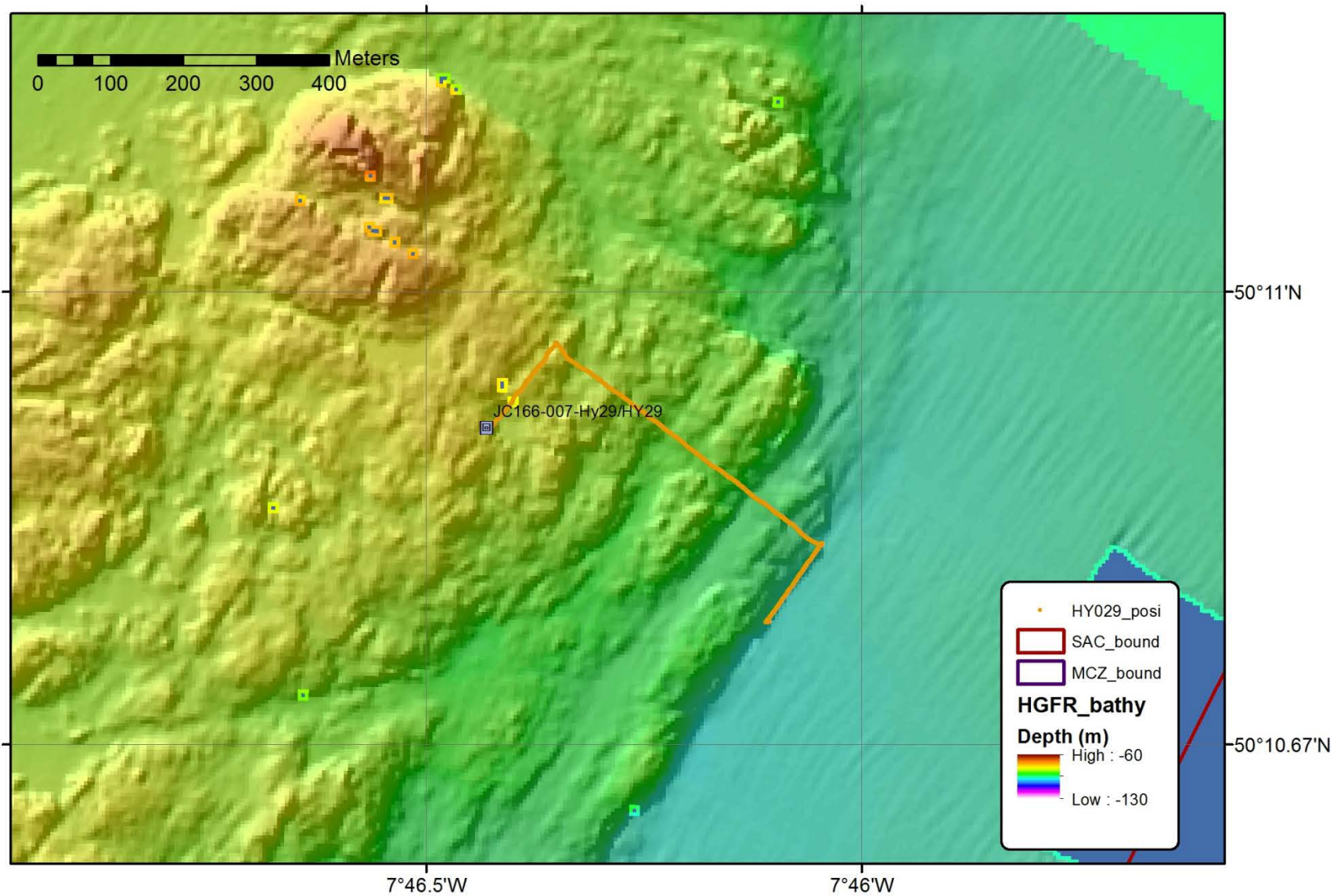

Overview of JC166 work in Whittard Canyon. New bathymetry data presented without hillshading:

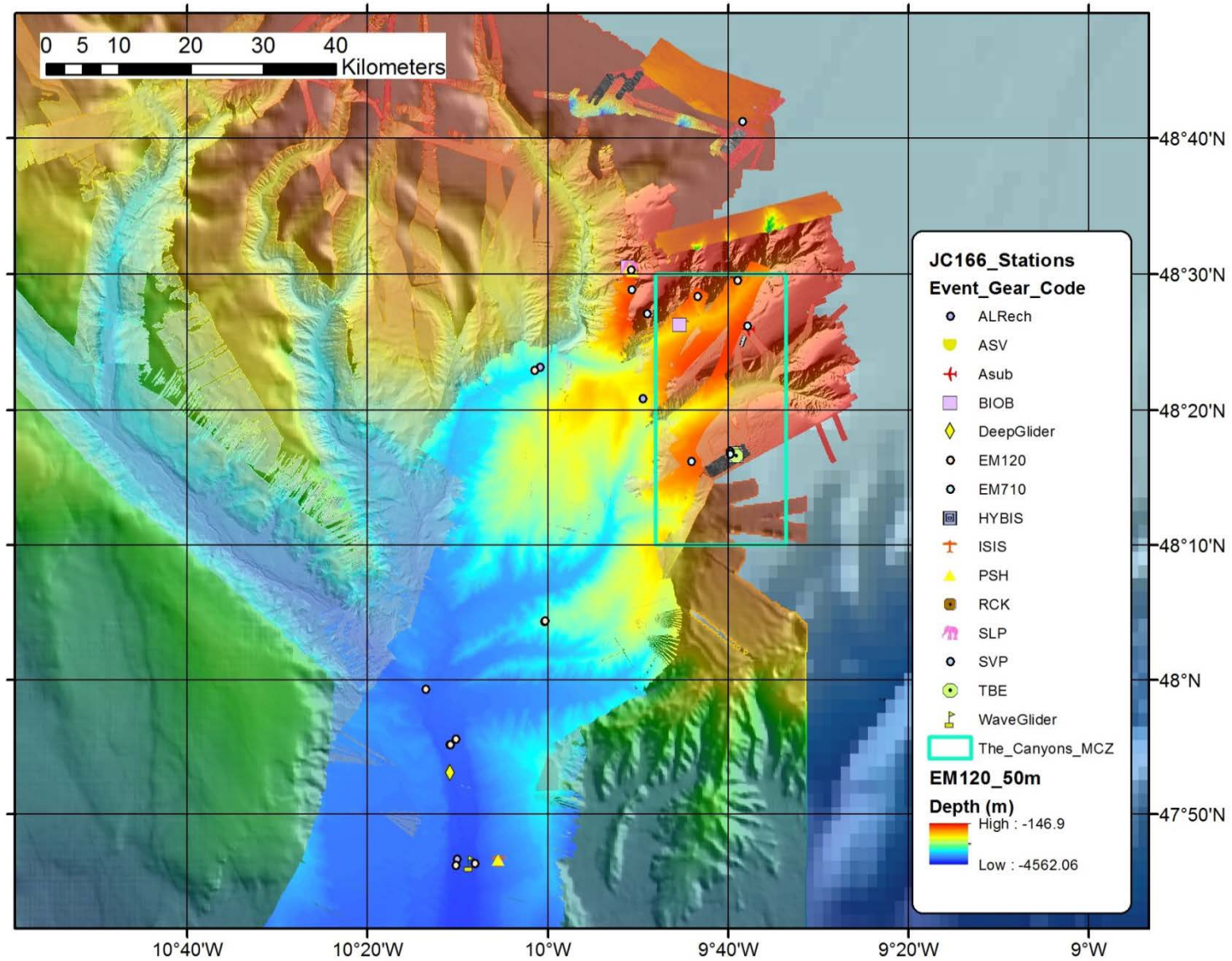

Whittard ISIS Dive 340:

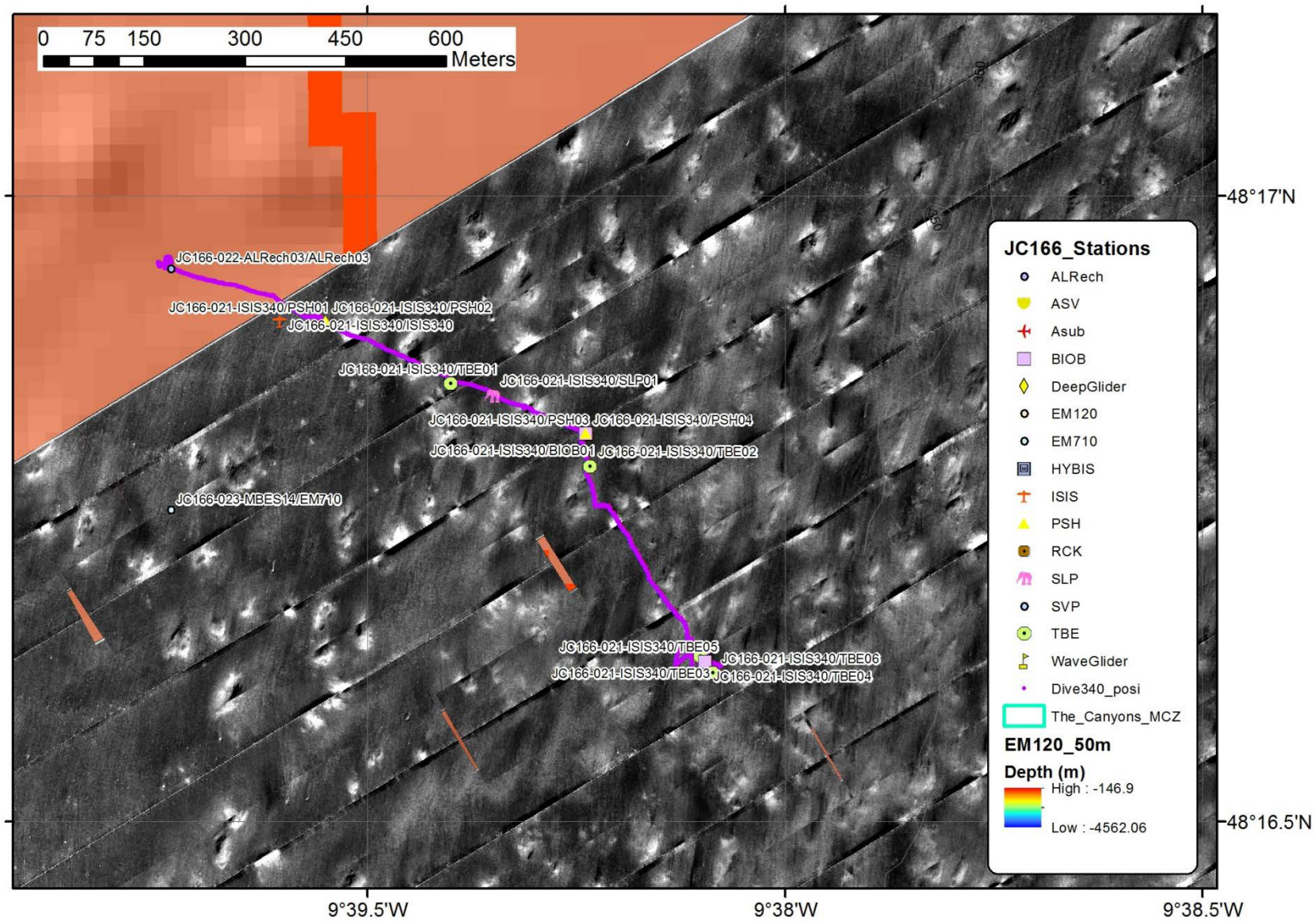

Whittard ISIS Dive343:

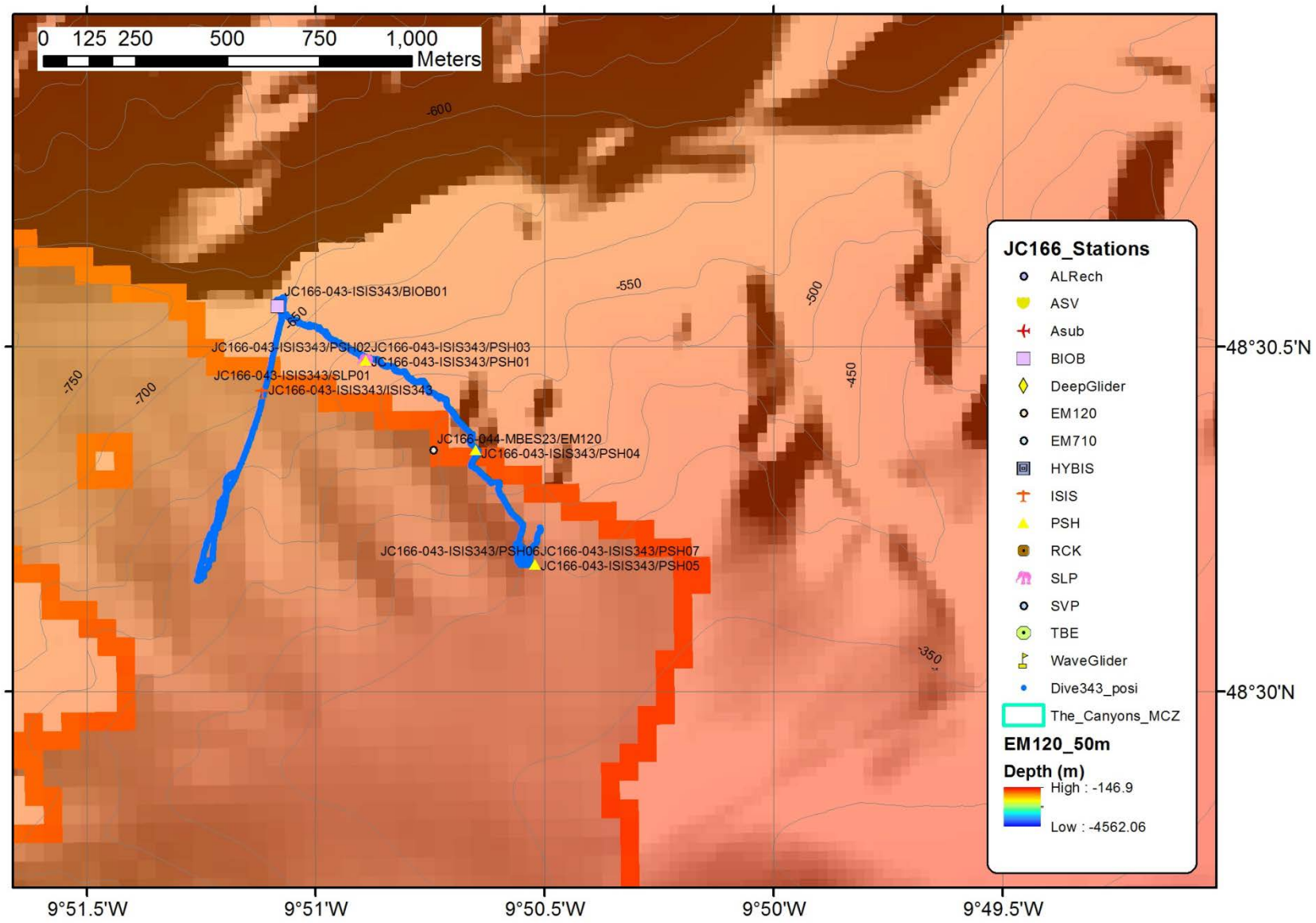

Whittard ISIS Dive 344:

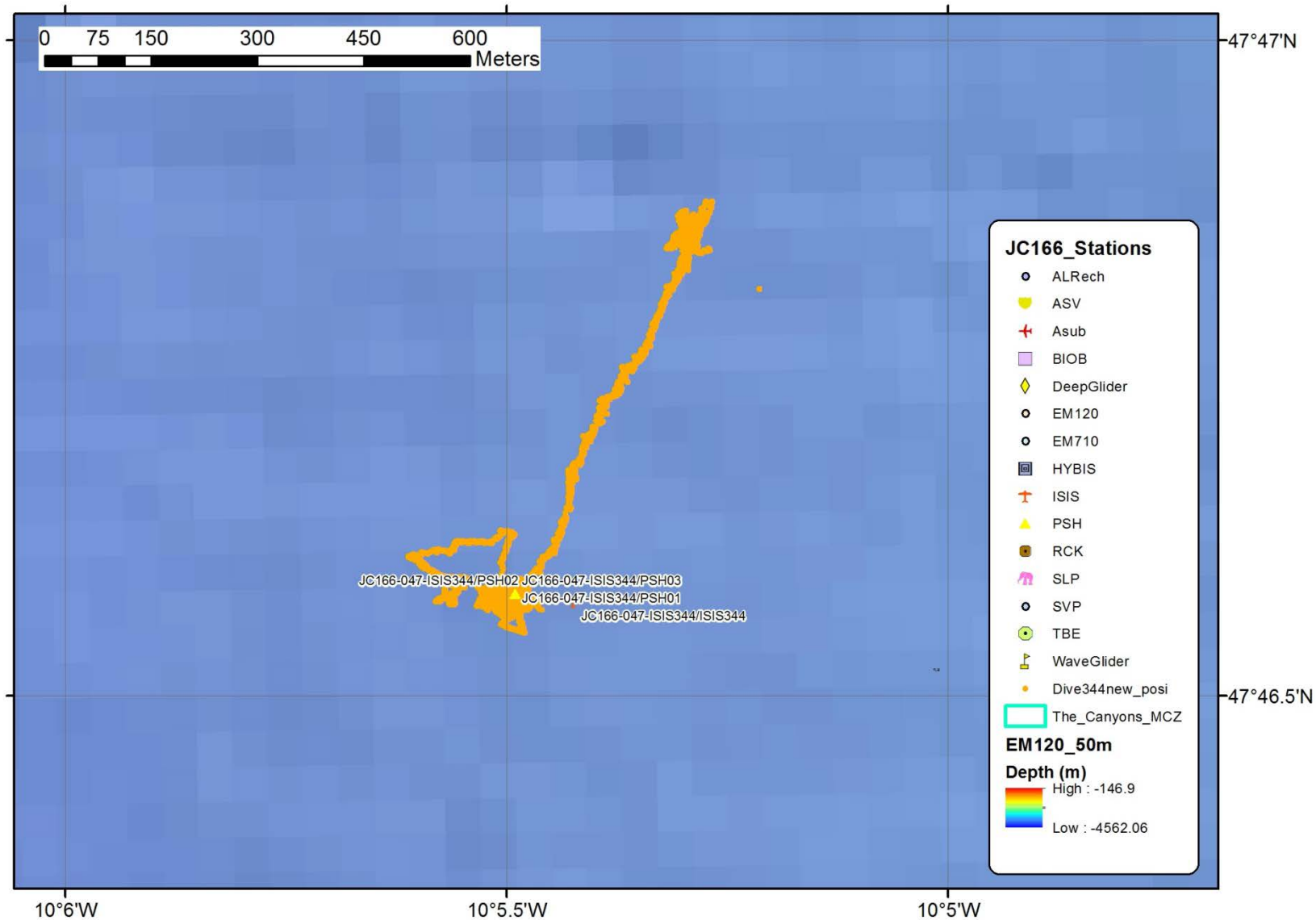

Whittard ISIS Dive 345:

