

CRUISE REPORT

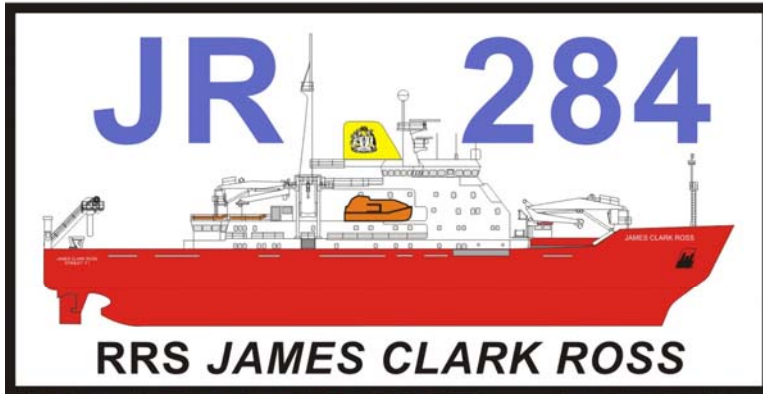

**Marine geology and
geophysics**

**Antarctic Peninsula
Pacific Margin**

January 2014

This page intentionally left blank

BAS Ref.: JR284

CRUISE REPORT

RRS James Clark Ross

Cruise JR284

January 2014

Marine geology and geophysics

Antarctic Peninsula Pacific Margin

R.D. Larter, C.L. Batchelor, M.J.B. Cartigny, J.G. Edmonston, E.J. Gowland,
C.-D. Hillenbrand, K.A. Hogan, J.Z. Klepacki, O.H. Meisel, S.D. Polfrey, J.A. Smith,
A.J. Tate

This unpublished report contains initial observations and conclusions. It is not to be cited without written permission of the Director, British Antarctic Survey.

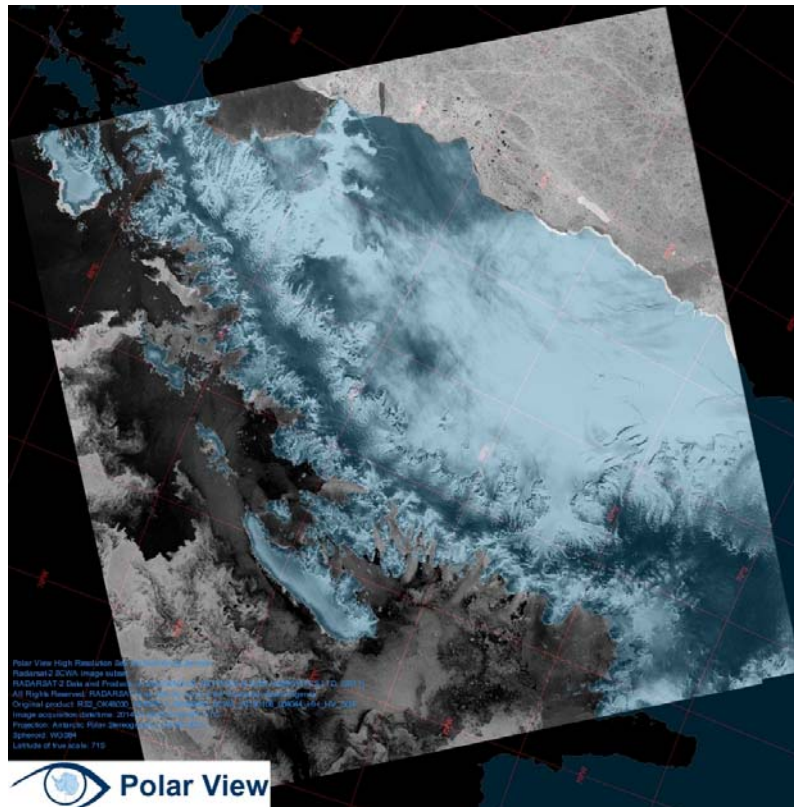

Frontispiece. A RADARAT-2 SCWA image showing the distribution of sea ice (white) west of the Antarctic Peninsula early on 8th January (top) and a view of sea ice from RRS James Clark Ross late on 7th January at 65° 18'S, 65° 50'W.

Contents

	Page	
1	Summary	1
2	List of Personnel	3
3	Timetable of Events	5
4	Introduction	7
5	Activity Reports	9
	5.1 TOPAS and swath bathymetry surveys	9
	5.2 Sediment coring	18
6	List of Scientific Equipment Used	22
7	Equipment Performance	24
	7.1 EM122 multibeam echo sounder	24
	7.2 TOPAS sub-bottom profiler	25
	7.3 EA600 echo sounder	26
	7.4 Gravity corer	26
	7.5 Box corer	30
	7.6 Cable Logging and Monitoring (CLAM) system	31
	7.7 CTD system	31
	7.8 Expendable bathythermograph (XBT) system	32
	7.9 Oceanlogger	32
	7.10 Shipboard Tree-Component Magnetometer (STCM)	32
	7.11 Navigation systems	32
	7.12 NOAA Shipboard Computing System (SCS)	33
8	ICT and AME Reports	35
9	Acknowledgements	43
10	Acronyms	44
11	Recommendations	45
Appendices		
A1	Bridge event log	46
A2	Coring station table	52
A3	CTD and XBT station table	54
A6	Typical Sonar System Parameter Settings	55

List of Figures

		Page
1	Track of RRS <i>James Clark Ross</i> during cruise JR284	2
2	Shipboard scientific party	4
3	Cruise location map showing and JR284 tracklines and main working areas	10
4	Survey lines in outer Marguerite Trough	13
5	Survey coverage in the Anvers Trough study areas	14
6	Preparation of the BAS gravity corer for a 9 m-deployment on cruise JR284	27
7	Heavily inclined seafloor surface in box core BC685	30
8	Very uneven, partly disturbed seafloor surface in box core BC720	30
9	Support bracket for Oceanlogger temperature sensors	39
10	SBE38 wiring schematic	40
11	Burnt TIR2 ND6011 shunt resistor(s).	41
12	Radiometer Circuit	41

Tables

1	Summary table of Sound Velocity Profiles (SVP's) used on JR284	11
2	EM122 surveys acquired on JR284	12

1. Summary

On cruise JR284 a programme of marine geological and geophysical work was carried out on the Antarctic Peninsula Pacific margin within the framework of the BAS IceSheets Programme. The primary aim of the cruise was to improve constraints on the deglacial history of the Antarctic Peninsula Ice Sheet. The data and samples collected will also be used in three Collaborative Gearing Scheme projects that are related to the primary cruise aim. These are:

- Constraints on ice-stream behaviour during retreat and deglacial chronology from geomorphology and seafloor sediments (PI: J.A. Dowdeswell, Scott Polar Research Institute, University of Cambridge; cruise participants: K.A. Hogan and C.L. Batchelor).
- Spatial variations in grounding-line proximal facies (PI: M. Cartigny, National Oceanography Centre).
- Testing a refugia hypothesis on the Antarctic Peninsula continental shelf, with implications for biology and past ice-sheet extent (PI: A.G.C. Graham, University of Exeter). Unfortunately, changes in the ship's itinerary during the early part of the season meant that A.G.C. Graham was unable to participate in the cruise.

The cruise dovetailed with BAS logistic activities, starting at Rothera Station after the JCR had made the first call of the season there. In parallel with JR284, a small amount of oceanographic work was carried out by a group of scientists from NOC (Liverpool) who had been assigned a separate cruise number (JR292).

The data and samples collected on cruise JR284 will provide new constraints on the dynamic behaviour of the expanded ice sheet during the Last Glacial Maximum and on the subsequent history of glacial retreat.

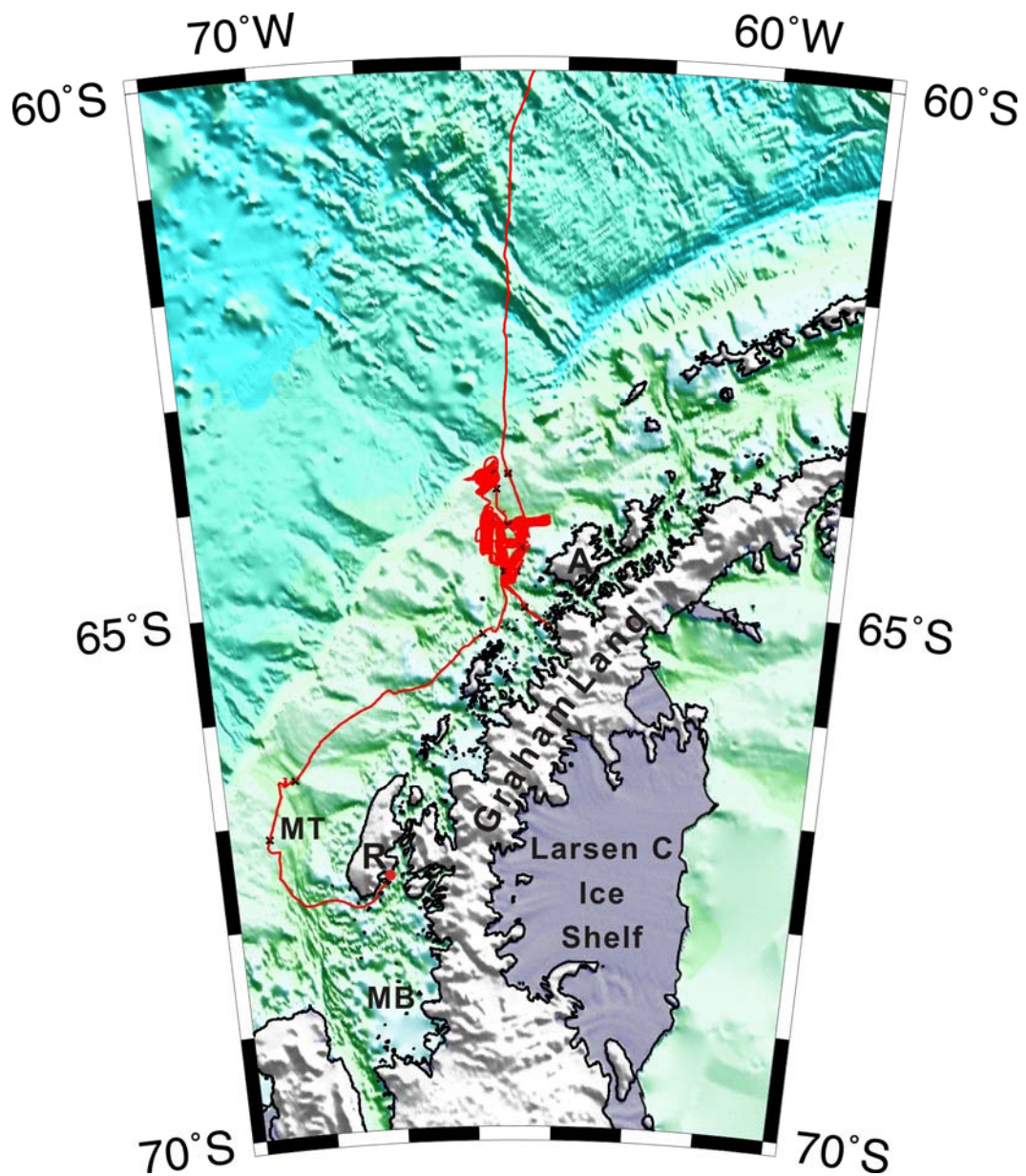

Figure 1. Track of RRS *James Clark Ross* during cruise JR284 (red) overlaid on shaded-relief display of International Bathymetric Chart of the Southern Ocean (IBCSO) bathymetry. A larger scale track chart is included as a fold out at the back of this report. A = Anvers Island; MB = Marguerite Bay; MT = Marguerite Trough; red dot labeled R = Rothera Station, Adelaide Island.

2. List of Personnel

2.1 Scientific and Technical (16)

R.D. Larter	BAS	Chief Scientist/Palaeo-Ice Sheets WPM
C.-D. Hillenbrand	BAS	Marine Geologist
J.A. Smith	BAS	Sedimentologist
K.A. Hogan	Univ. of Cambridge/BAS*	Marine Geophysicist
C.L. Batchelor	University of Cambridge	PhD student (Marine Geophysicist)
M. Cartigny	NOC	Sedimentologist
O.H. Meisel	AWI/Univ. of Bremen	MSc student (Marine Geologist)
A.J. Tate	BAS	Head of BAS Information Services
E.J. Gowland	BAS	Data Manager
S.D. Polfrey	BAS	AME (Mechanical Engineer)
J.Z. Klepacki	BAS	AME (Electronic Engineer)
J.G. Edmonston	BAS	ICT (Computing Engineer)
H.E. Woodland	BASMU	Doctor

JR292:

M.A. Morales Maqueda	NOC	JR292 PI/Oceanographer
J.P. Pugh	NOC	Oceanographic instrumentation engineer
J. Mead Silvester	NOC	PhD student (Oceanographer)

BAS = British Antarctic Survey; NOC = National Oceanography Centre; AWI = Alfred Wegener Institute; AME = BAS Antarctic & Marine Engineering Section; BASMU = BAS Medical Unit; ICT = BAS Information Communications Technology Section; WPM = Workpackage Manager.

* K.A.Hogan started working for BAS on 6th January, having previously been employed as a postdoctoral researcher at the Scott Polar Research Institute, University of Cambridge.

2.2 Ship's Company (28)

G.P. Chapman	Master	G.M. Stewart	Bosun SciOps
S.D. Evans	Chief Officer	C. Mullaney	Bosun
C.W. Hipsey	2 nd Officer	J.P. O'Duffy	Bosun's Mate
G.M. Delph	3 rd Officer	D.W. Triggs	Seaman
L.T. Parnell	Chief Engineer	C.J. Leggett	Seaman
G. Collard	2 nd Engineer	T.M. Riddell	Seaman
A.J. Hardy	3 rd Engineer	N.M. Cordiner	Seaman
S.J. Eadie	4 th Engineer	M.P. Dyer	Seaman
C.A. Waddicor	Radio Officer	M.A. Robinshaw	Motorman
S.A. Wright	Deck Engineer	I.P. Herbert	Motorman
N.J. Dunbar	Electrical Engineer	K.A. Walker	Chief Cook
J.S. Gibson	Purser	P.G. Molloy	2 nd Cook
		K. Weston	Senior Steward
		J. Newall	Steward
		D.W. Lee	Steward
		T.R. Patterson	Steward



Figure 2. JR284 shipboard scientific party, with Anvers Island in the background.
From left to right: E.J. Gowland, K.A. Hogan, R.D. Larter, A.J. Tate, S.D. Polfrey,
J.Z. Klepacki, J.A. Smith, C.L. Batchelor, O.H. Meisel, C.-D. Hillenbrand,
M.J.B. Cartigny, J.G. Edmonston

3. Timetable of Events

January 2014

- 1 Embarkation, at 1900 local time, of those members of the scientific party who had not already joined the ship in the Falkland Islands.
- 2-4 Station relief and cruise mobilisation.
- 5 RRS *James Clark Ross* departed from Bischof Wharf, Rothera at 0815 local time (1115Z). Boat drill south of Jenny Island. Multibeam echo sounder and TOPAS logging started. Work in first planned study area abandoned due to ice cover.
- 6 Slow progress through ice to outer part of Marguerite Trough. Coring in outer part of Marguerite Trough. Further study of area abandoned due to ice cover. Start transit northwards to contingency study area west of Anvers Island.
- 7 Initial multibeam and TOPAS survey lines along Anvers Trough.
- 8 Visit to Vernadsky Station for JR292 scientists to download data from the tide gauge there and service it. Multibeam and TOPAS data collection on approach to station across inner shelf and through French Passage. Gravity core in small, enclosed, relatively shallow basin on the inner shelf.
- 9 Multibeam and TOPAS survey along mid-shelf part of Anvers Trough. Coring and CTD near front of mid-shelf grounding zone wedge. FETCH deployed for JR292.
- 10 Multibeam and TOPAS survey towards western flank of Anvers trough. Coring in southern part of Anvers Trough.
- 11 Multibeam and TOPAS survey on eastern side of area surveyed earlier. Long profiles across Anvers Trough to south and north of mid-shelf grounding zone wedge. Coring at sites along northern transverse profile. Visit to FETCH site and data download for JR292. Transit to outer shelf.
- 12 Multibeam and TOPAS survey over outer shelf part of Anvers Trough. Coring and CTD near front of outer shelf grounding zone wedge.
- 13 Multibeam and TOPAS survey over outer shelf part of Anvers Trough. Transit back to mid-shelf part of Anvers Trough. Multibeam and TOPAS survey over inner-to-mid shelf transition within eastern part of the trough
- 14 Multibeam and TOPAS survey within eastern part of Anvers trough extended northward. Coring in central southern part of the trough.

- 15 Multibeam and TOPAS survey within eastern part of Anvers trough extended still further northward to encompass confluence with eastern tributary.
- 16 Multibeam and TOPAS survey over mid-shelf part of eastern tributary to Anvers Trough. Coring in same area. Started passage to Punta Arenas.
- 17-19 Passage to Punta Arenas, collecting multibeam echo sounding and TOPAS data in transit. TOPAS logging stopped at 0108 on 17th January. Multibeam logging stopped at 0432 on 18th January.
- 20 RRS *James Clark Ross* arrived at Punta Arenas at 1615 local time (1915Z).

4. Introduction

JR284 was planned at short notice within the National Capability remit of the BAS IceSheets Programme, in collaboration with partners at the Scott Polar Research Institute, the National Oceanography Centre and Exeter University, to make effective use of a gap that developed within the RRS *James Clark Ross* itinerary as a result of the late postponement of a scheduled cruise. An International Ocean Discovery Programme (IODP) site survey cruise, funded by a grant from the NERC UK IODP Programme (PI: R.D. Larter), had been scheduled to span the time during which JR284 took place. However, difficulties in obtaining seismic equipment and adequate technical support resulted in the postponement of that cruise to the 2014/15 season. The JR284 science plan was designed to address outstanding uncertainties in the deglacial history of the Antarctic Peninsula Ice Sheet, while fitting with BAS logistic constraints. Hence the cruise started at Rothera Station after the JCR had made the first call of the season there. The planning of the cruise illustrates how NERC's National Capability funding can enable very effective, responsive use of resources to facilitate collaborative research.

Sea ice conditions in January are usually favourable for ship-based work to the west of the Antarctic Peninsula. Nevertheless, contingency study areas that would allow most of the thematic objectives of the cruise to be addressed were identified on the northern part of the continental shelf, in case sea ice persisted longer than usual farther south. In the event, extensive sea ice cover was present as far north as 65°S at the start of the cruise, so attention switched to the contingency study areas offshore from Anvers Island.

The IceSheets/Chemistry and Past Climate gravity coring system was used for the third season out of four since it was commissioned. The corer was the main sea-floor sampling device used on the cruise and a large number of cores were recovered. The core barrels and liners are of a larger diameter (130 mm and 110 mm, respectively) than those used with most gravity corers, as core diameter is a significant factor affecting recovery in glacial sediments. This system provides BAS with the means to recover sea-floor sediment cores with minimal recurrent costs, compared to the tens of thousands of pounds it would cost to source coring equipment and associated technical support from another NERC Research Centre.

Despite that fact that sea ice conditions made working in some intended study areas impractical, the cruise was successful in achieving a range of scientific objectives:

Achievements

- First comprehensive multibeam bathymetry and sub-bottom acoustic profiler surveys over the middle and outer shelf parts of Anvers Trough, one of the main palaeo-ice stream paths on the western side of the Antarctic Peninsula.
- A transect of sediment cores collected along Anvers Trough to constrain the chronology of its deglaciation.
- Comprehensive surveys covering three grounding zone wedges (GZWs), allowing their dimensions to be established and detailed study of their morphology. Sediment cores collected in front of and behind each one provide the potential to constrain the times of formation and growth rates of the GZWs.
- A transect of sediment cores across Anvers Trough to allow spatial variations in grounding line facies to be examined.
- Comprehensive multibeam bathymetry coverage over, and sediment cores within, an enclave between an outer shelf GZW and the continental shelf edge, allowing evaluation of the possibility that such areas might have remained free of grounded ice during the Last Glacial Maximum and thus provided refugia for shelf benthic communities.

5. Activity Reports

5.1 TOPAS and swath-bathymetric surveys

Kelly Hogan, Rob Larter, Christine Batchelor, Alex Tate, Elanor Gowland

5.1.1 Objectives

The objectives of the marine geophysical work undertaken on JR284 were:

- i. To acquire new high-resolution bathymetric data and sub-bottom profiles in targeted survey areas in order to map the seafloor geomorphology and to image the sub-seabed sedimentary architecture.
- ii. To aid identification of potential sites for strategic coring and possibly dredging activities.
- iii. To provide important geological context for sediment cores, and any ice, climate, and oceanic records contained therein.

Shipborne geophysical data were acquired using a hull-mounted Kongsberg-Simrad EM122 multibeam echo sounder for the bathymetric data, and a TOPAS PS018 parametric echo sounder for the sub-bottom profile data.

The TOPAS and EM122 systems were run simultaneously for the majority of the cruise and can, therefore, be considered a single survey. The exception to this was between core stations located close to each other where good multibeam data already existed; in these instances only the TOPAS data was logged between the sites to aid identification of optimal coring sites. Survey areas in middle and outer Marguerite Trough (1, 2) had to be abandoned because of severe sea-ice cover. As such, the main geophysical survey sites for JR284 were Anvers Trough middle shelf (3) and Anvers Trough outer shelf and slope (4; Figure 1).

Prior to the cruise existing marine geophysical and geological data for the Marguerite and Anvers trough areas of the western Antarctic Peninsula were compiled and plotted as A1 maps to aid survey planning at sea. These data included previous multibeam-bathymetric data (BAS, UKHO, US Antarctic Program, AWI, Hesperides) and the locations of seismic reflection profiles (deep-tow boomer, SCS, MCS) as well as sediment cores. Seismic profile and sediment core locations were plotted over the bathymetric data, which were gridded with a cell-size of 50 m. TOPAS datasets from cruises JR71, JR59 and JR157 to Marguerite Trough were also available on the cruise. These existing datasets, together with regional topographic compilations (e.g. IBCSO v.1; Arndt et al., 2013), were used as the principle forms of planning, navigation and survey design.

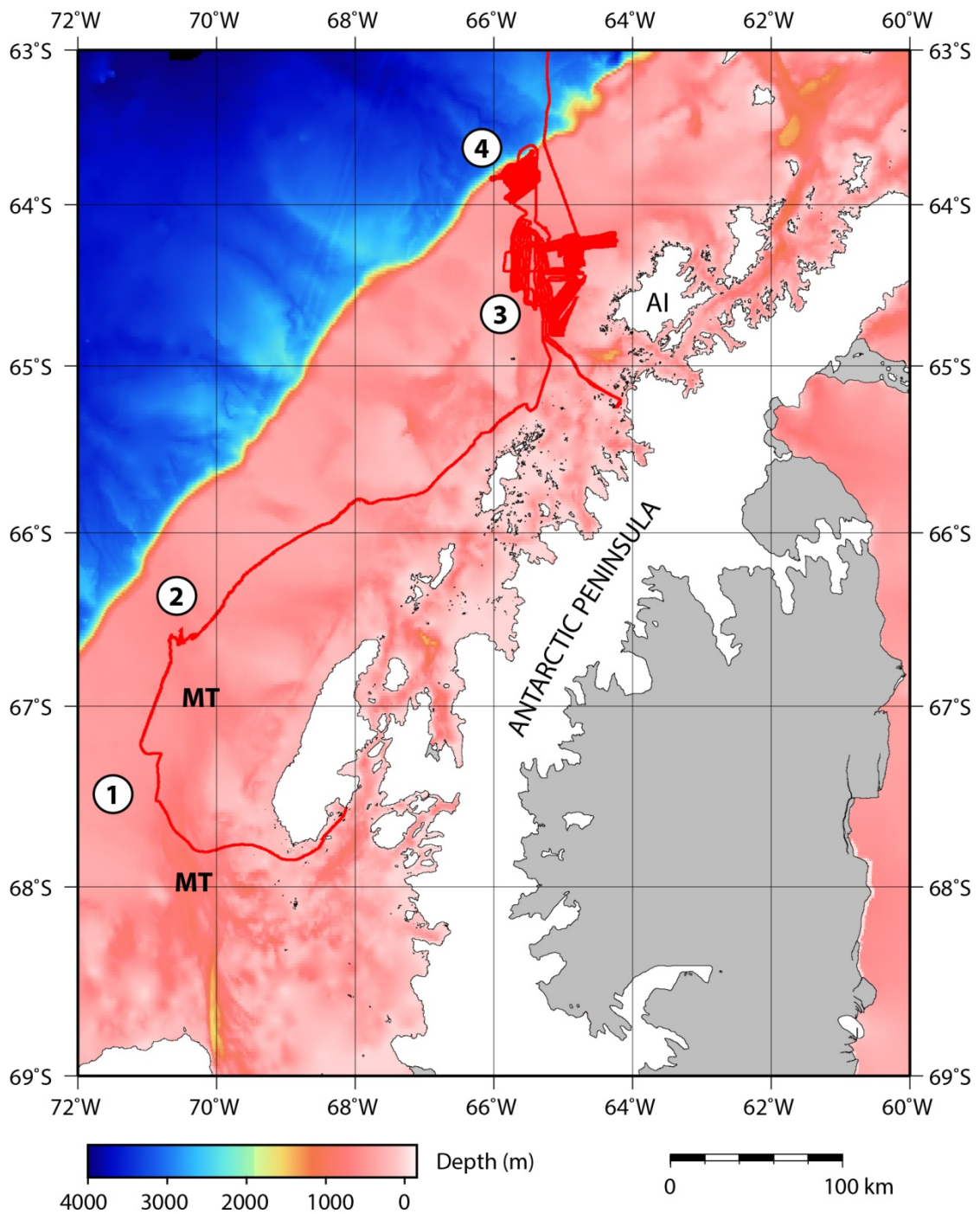

Figure 3. Cruise location map showing and JR284 tracklines (red) and main working areas (numbered): (1) western Marguerite Trough middle shelf (abandoned), (2) Marguerite Trough outer shelf (abandoned), (3) Anvers Trough middle shelf, (4) Anvers Trough outer shelf. MT is Marguerite Trough; AI is Anvers Island. Regional bathymetry from IBCSO v.1 (Arndt et al., 2013); map projected with a Mercator (WGS84) projection.

File name (SVP)	CTD /XBT	Latitude collected (degrees dec. min. S)	Longitude collected (degrees dec. min. W)	Date-time collected	Date-time active (JD /hh:mm:ss)	Notes
T5_00011_thinned.asvp	XBT	62 20.3877	57 53.0527	30/12/2013 17:19	005 / 15:04:00	Collected on cruise JR312, folder = 20131220
T7_0001_thinned.asvp	XBT	64 45.660	65 17.880	08/01/2014 04:11	008 / 04:37:00	Cruise folder = 20140104
JR284_694_thinned.asvp	CTD	64 14.584	65 28.680	09/09/2014 20:57	009 / 22:45:00	Original file renamed to JR284_001
JR284_002_thinned.asvp	CTD	63 52.611	65 41.375	12/01/2014 21:30	012 / 22:30:00	
JR284_694_thinned.asvp	CTD	64 14.584	65 28.680	09/01/2014 20:57	013 / 14:32:00	Original file renamed to JR284_001
T7_0002_thinned.asvp	XBT	60 59.700	65 05.770	17/01/2014 16:14	017 / 16:21:00	

Table 1. Summary table of Sound Velocity Profiles (SVPs) used on JR284, as recorded in the EM122 cruise underway log, including the dates and times that each one was active for EM122 logging. A CTD and XBT station list is also given in Appendix A3.

5.1.2 Work at sea

The hull-mounted Kongsberg-Simrad EM122 multibeam echo sounder was used near-continuously during cruise JR284. The EM122 was run in high density mode, where soundings are derived from more than one point within a beam, with up to 432 beams per swath with a normal operating frequency of 12 kHz (frequency range of 11.25-12.75 kHz). This provides a spatial resolution of between c. 10-70 m (dependent on water depth). The swath width of the EM122 is typically 6 times the survey water depth to almost 4000 m depth with full beamwidth (75°/75° beam angles) or 5 times the water depth with c. 68° beam angles. Beam raypaths and seafloor depths were calculated in near-real-time using sound velocity profiles (SVPs) derived from conductivity-temperature-depth (CTD) and expendable bathythermograph (XBT) casts acquired during both JR312 and during cruise operations (a table of SVPs used during JR284 is presented in Table 1).

Multibeam-bathymetric and TOPAS surveys were focused primarily in Anvers Trough at the target locations (3) and (4) shown in Figure 1. Where features of interest were identified, blocks of the seafloor were mapped out with a survey of overlapping swaths; swath overlap was between 15-25% in surveyed areas. Outside of the target areas individual lines were recorded routinely on transit to and from survey areas, as well as on passage from Rothera at the start of the cruise, and to Punta Arenas at the end of the cruise. The following sections

describe and illustrate the coverage of the JR284 survey data. Table 2 lists the different multibeam surveys recorded during the cruise, along with the start/end times, number of lines collected, and a brief description of the working locality.

Survey name	Name of survey area	Start time (JD/Time)	Start time of last file	No. of lines
JR284_a	Rothera to Anvers Trough	005 / 15:04:31	008 / 00:27:00	45
JR284_b	Anvers Trough survey	008 / 01:28:10	017 / 02:35:08	179
JR284_c	Anvers Trough to 200 miles from Punta Arenas	017 / 04:33:04	018 / 04:32:00	23

Table 2. EM122 surveys acquired on JR284.

In total, approximately 3100 line-km of multibeam-bathymetric data were acquired. TOPAS data were collected simultaneously (in RAW and SEGY formats), except for seaward of the shelf break on the passage back to Punta Arenas from the Antarctic Peninsula. Processing of the bathymetric data to remove erroneous pings was mostly completed onboard, using the MB-System software on Unix and Linux platforms, and will be completed on return to BAS Cambridge.

5.1.3 Aims, approach, and preliminary observations by working area

(1) West of Marguerite Trough (middle shelf)

Aims and Approach: The goal of surveying west of Marguerite Trough (MT) was to investigate a possible grounding-zone wedge (GZW) identified from existing single beam echo-sounding profiles.

Preliminary observations: Extensive sea-ice cover in areas west of MT prevented the JCR from reaching the targeted study area.

(2) Outer Marguerite Trough (Fig. 2)

Aims: There were three aims for surveying in outer MT. First, to identify and conduct a survey of the palaeo-shear margin of the MT palaeo-ice stream in order to constrain ice-stream width and study the geomorphology of a known palaeo- shear margin. Second, to identify core sites that might provide new deglacial dates for the outer shelf in this part of the Antarctic Peninsula. To date the only reliable date on outer shelf of MT is 12.9 cal. kyrs BP (Pope and Anderson, 1992; recalibrated in Livingstone et al., 2012), and the timing of initial

retreat of the ice sheet from the shelf break in this location is relatively late compared with the rest of the western Antarctic Peninsula (cf. Ó Cofaigh et al., *submitted*). Third, to survey a seafloor feature identified on existing multibeam-bathymetric data as a possible GZW on the outermost shelf.

Approach: Extensive sea-ice cover over much of the targeted survey area meant that bathymetric surveying of the GZW and palaeo-shear margin in outer MT was not possible. Two viable outer shelf core sites were identified on existing TOPAS profiles and bathymetric data from cruise JR71. During JR284 TOPAS data were used to survey across and subsequently pinpoint these sites for coring. The data also provided additional acoustic stratigraphic information for existing sediment cores in the area.

Preliminary observations: No significant blocks of bathymetric data were collected in MT due to the poor sea-ice conditions.

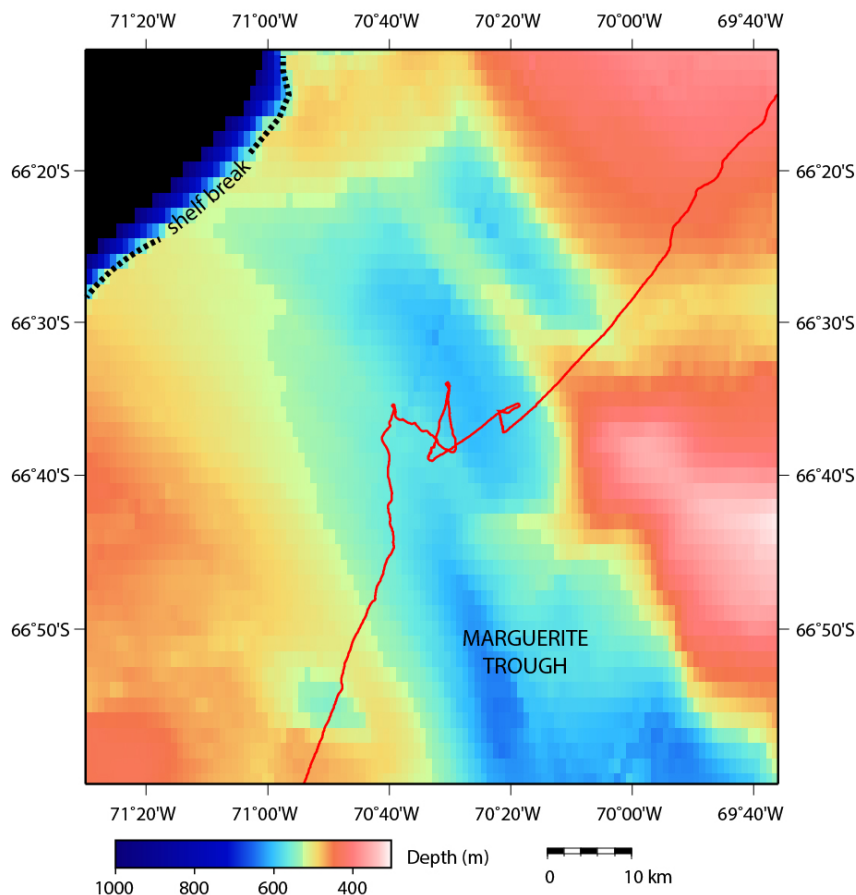

Figure 4. Survey lines in outer Marguerite Trough, Mercator projection.

(3) Anvers Trough, middle shelf (Fig. 3)

Aims: Anvers Trough is a glacially-eroded cross-shelf trough on the western Antarctic Peninsula shelf offshore of Anvers Island that was almost certainly overridden by an ice

stream during the LGM. Studies of geomorphic features from side-scan sonar and seismic reflection data acquired in the 1980s and 1990s (Pudsey et al., 1994; Larter and Vanneste, 1995; Vanneste and Larter, 1995), as well as later multibeam-bathymetric surveys (Heroy and Anderson, 2005), show that mega-scale glacial lineations (MSGL) extend on to the outer shelf in the trough. Studies of the side-scan sonar and seismic data also identified two grounding-zone wedges in the trough, one on the outer shelf and one on the mid-shelf (Vanneste and Larter, 1995). Despite these findings, multibeam-bathymetric coverage in Anvers Trough, particularly on the middle-outer shelf areas is relatively poor. The aim of JR284 geophysical surveys in Anvers Trough on the mid-shelf was to investigate and map the seafloor geomorphology of this cross-shelf trough to provide evidence for LGM (or earlier) ice-flow paths and extents, subglacial or ice-marginal features formed during ice maxima and (or) retreat, and to help identify suitable locations for gravity coring.

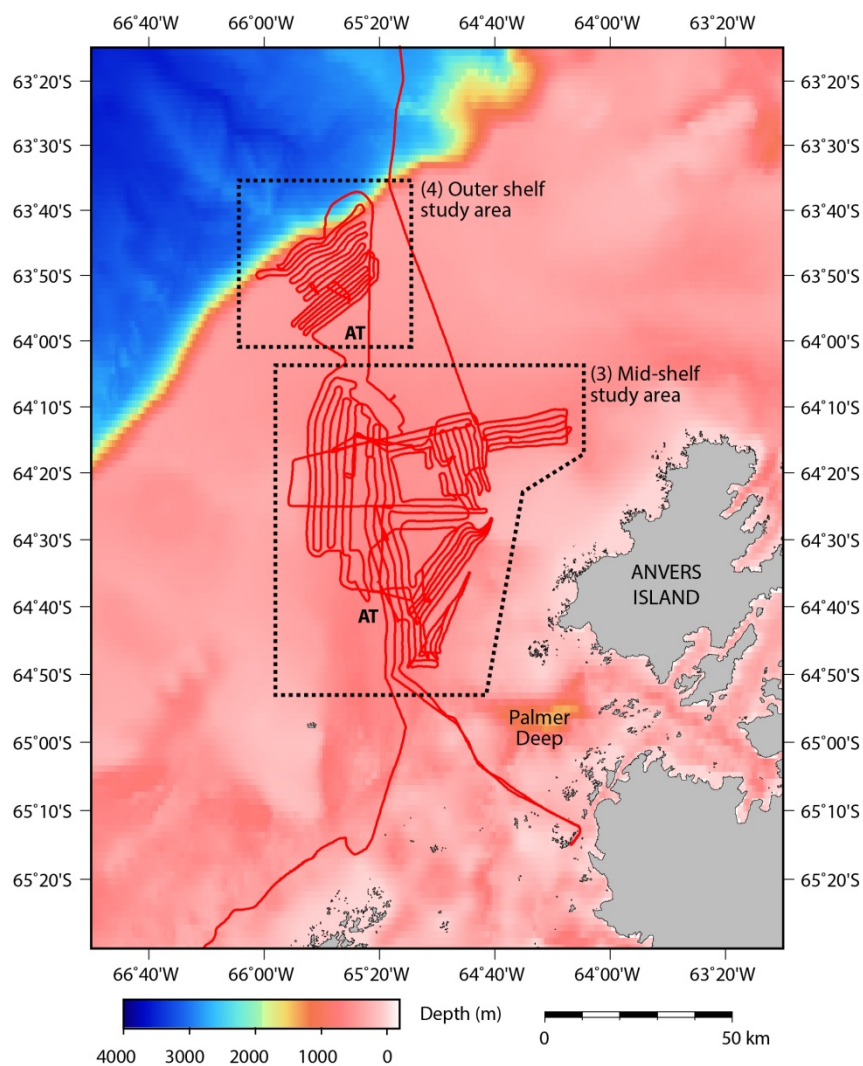

Figure 5. Survey coverage in the Anvers Trough study areas. Mercator projection (WGS84).

Approach: The Anvers glacial trough (western part) was mapped systematically to add bathymetric coverage to existing surveys in the area. The objective on the middle shelf was to map the extent of grounding-zone features known from seismic reflection profiles, to extend the survey on to the banks of the trough to characterise the geomorphology of the lateral margins of the Anvers Trough palaeo-ice stream, and to image sub-seafloor sediment units within these targets.

Multibeam and TOPAS surveys were carried out predominantly on north-south overlapping lines along the axis of Anvers Trough although the orientation of tracklines varied in order to map coherent blocks of seafloor in addition to existing multibeam data. Two across-trough lines were also run in order to image sub-seafloor sediments of grounding-line features in a strike direction as well as in the dip direction provided by the north-south lines.

Preliminary observations:

- Former ice grounding in the landward-dipping Anvers Trough is evident from the presence of streamlined glacial bedforms on the seafloor although these features have been obliterated above c. 530 m present-day water depth by iceberg scouring.
- Multiple grounding-line features were identified on the middle shelf of Anvers Trough although the distribution and morphology of these features is variable and somewhat complex. The grounding-line features comprised wedges of acoustically-transparent material on TOPAS records.
- The TOPAS profiles revealed a relatively thick, conformable unit of postglacial sediments on the middle-outer shelf draping significant acoustically-transparent units of varying thickness in the trough. These transparent units pinch out against the trough flanks. The postglacial drape package thickened on the inner shelf where it also becomes clearly stratified.
- Multibeam data for the middle shelf was largely processed to remove the most significant erroneous beams during JR284; the remaining lines will be processed at BAS Cambridge.

(4) Anvers Trough, outer shelf (Fig. 3)

Aims: The objective of geophysical mapping on the outer shelf of Anvers Trough was to characterise the geomorphology and sub-seafloor sediment units of a grounding-line feature identified from deep-tow boomer data (cf. Vanneste and Larter, 1995). In addition, surveying was required to identify the most suitable sites for gravity coring on the outer shelf with the aim of recovering undisturbed post-glacial sediment to obtain a deglacial age. A secondary aim of surveying in this area was to collect bathymetric data across the shelf break and on the upper continental slope to determine the nature of any gullying at the mouth of the Anvers Trough.

Approach: The approximate location of a “wedge” of sediment was known from the deep-tow boomer survey acquired on the JCR in 1992 (Vanneste and Larter, 1995). Multibeam lines were planned to systematically cover the seafloor both landward and seaward of the wedge front to ensure full coverage of this feature, and to identify site for gravity coring. Lines were run in a northeast-southwest orientation because this direction was optimal for data quality in the wind/swell conditions at the time of survey.

Preliminary observations:

- The wedge front was mapped as a subtle escarpment with two “embayments” in its planform. Water depths seaward of the embayments are great enough that these areas have not been affected by iceberg scouring. Three sites that were suitable for coring were identified from the bathymetric and TOPAS data.
- Bathymetric data from the upper slope reveal limited gullying at the shelf break seaward of the eastern part of the trough mouth compared to more extensive gully systems known from the western trough mouth (Heroy and Anderson, 2005).
- Only a few amphitheatre-shaped gully heads incise the shelf break but gullies are more developed on the middle slope in water depths greater than c. 800 m.

References

- ARNDT, J.E., SCHENKE, H.W., JAKOBSON, M., NITCHE, F.O., BUYS, G., GOLEBY, B., REBESCO, M., BOHOYO, F., HONG, J., BLACK, J., GREKU, R., UDINTSEV, G., BARRIOS, F., REYNOSO-PERALTA, W., TAISEI, M. and WIGLEY, R., 2013. The International Bathymetric Chart of the Southern Ocean (IBCSO) version 1.0 - A new bathymetric compilation covering circum-Antarctic waters. *Geophysical Research Letters*, 40, 3111–3117.
- HEROY, D.C. and ANDERSON, J.B., 2005. Ice sheet extent of the Antarctic Peninsula region during the last glacial maximum (LGM) – insights from glacial geomorphology. *Geological Society of America Bulletin*, 117, 1497–1512.
- LARTER, R. D. and VANNESTE, L. E., 1995. Relict subglacial deltas on the Antarctic Peninsula outer shelf. *Geology*, 23, 33–36.
- LIVINGSTONE, S. J., Ó COFAIGH, C., STOKES, C. R., HILLENBRAND, C.-D., VIELI, A., and JAMIESON, S. S. R., 2012. Antarctic palaeo-ice streams. *Earth-Science Reviews*, 111, 90–128.
- POPE, P.G. and ANDERSON, J.B., 1992. Late Quaternary glacial history of the northern Antarctic Peninsula’s western continental shelf: evidence from the marine record. *Antarctic Research Series*, 57, 63–91.
- PUDSEY, C.J., BARKER, P.F., LARTER, R.D., 1994. Ice sheets retreat from the Antarctic Peninsula shelf. *Continental Shelf Research*, 14, 1647–1675.

Ó COFAIGH, C., DAVIES, B. LIVINGSTONE, S. J., SMITH, J. A., JOHNSON, J., HOCKING, E.,
HODGSON, D., ANDERSON, J. B., BENTLEY, M. CANALS, M., DOMACK, E.,
DOWDESWELL, J. A., EVANS, J., GLASSER, N., HILLENBRAND, C. D., LARTER, R. D.,
ROBERTS, S. and SIMMS, A., submitted. Reconstruction of ice-sheet changes in the Antarctic
Peninsula since the Last Glacial Maximum.

VANNESTE, L. E. and LARTER, R.D., 1995. Deep-tow boomer survey on the Antarctic Peninsula
Pacific margin: an investigation of the morphology and acoustic characteristics of Late
Quaternary sedimentary deposits on the outer continental shelf and upper slope. *Antarctic
Research Series*, 68, 91-121.

5.2 Sediment coring

Claus-Dieter Hillenbrand, James A. Smith, Scott Polfrey, Matthieu Cartigny, Ove Meisel

5.2.1 Objectives

The objectives of gravity and box coring on cruise JR284 were:

Recovery of sedimentary sequences seaward, on top and landward of grounding-zone wedges (GZWs) in the Anvers palaeo-ice stream trough, western Antarctic Peninsula, to determine the timing and duration of GZW formation and the lithology, spatial and stratigraphic variability of GZW sediments.

Recovery of sedimentary sequences along transects from the outer to inner shelf along the main axis of Anvers Trough and perpendicular to it for (i) studying the lithology, sedimentology and physical properties characterising the substrate of (sub-)glacial bedforms that were observed in the EM122 multibeam swath bathymetry and TOPAS acoustic subbottom profiler surveys (see chapter 5.1), (ii) analysing the lithology, sedimentology and physical properties characterising the sediments at the margins of palaeo-ice stream troughs, (iii) characterising the style of palaeo-ice stream retreat, and (iv) reconstructing the timing of grounding-line retreat since the Last Glacial Maximum (LGM).

Recovery of sedimentary sequences from the outermost shelf in the Marguerite and Anvers palaeo-ice stream troughs to investigate whether and when the grounding line of the Antarctic Peninsula Ice Sheet has reached the shelf break in the troughs at the LGM.

5.2.2 Work at sea

Long sedimentary sequences were recovered using the BAS gravity corer while surface sediment samples were collected with the BAS box corer. The gravity coring involved deployments of 3 m, 6 m and 9 m long gravity corers (*note: the liners had to be cut significantly shorter than the corresponding barrels, i.e. only a ca. 2.70 m long liner fits into a 3 m barrel and only a ca. 5.40 m long liner fits into a 6 m barrel, etc.*). Core sites were usually selected on the basis of the EM122 multibeam swath bathymetry and TOPAS acoustic subbottom profiler data (see chapter 5.1) but for the sites from outer Marguerite Trough (GC682 to GC686) the ship had to be positioned in nearby leads within dense sea-ice cover.

Outer shelf of Marguerite Trough: Coring targets in the outer shelf part of Marguerite Trough were selected on the basis of TOPAS profiles collected during cruise JR71. However, coring

at the selected sites was not possible because of dense sea-ice coverage and sea-ice drift, respectively, and three 3 m long gravity cores and two box cores (GC682/BC683, GC684/BC685/GC686) were recovered in nearby leads instead. Deployments of cores GC682, BC683 and BC685 were successful, with core GC682 recovering a ~1.3 m long sequence with gray stiff muddy diamicton at its base (shear strength in core cutter: 52 kPa). However, gravity core GC684, which recovered ~2.4 m of sediment, had slightly over-penetrated the seabed (which was apparent from sediment within the core bomb column). Therefore, a 6 m long gravity core (GC686) was deployed at the same site which successfully recovered a ~2.8 m long sequence with a gray soft muddy diamicton at its base.

Inner shelf part of Anvers Trough: Coring in Anvers Trough started with the opportunistic deployment of a gravity corer in its inner shelf part. During the transit to the Ukrainian Vernadsky station, which is located on one of the Argentine Islands, a small, locally restricted pocket of sediment in shallow bedrock was discovered in the TOPAS data. The site was targeted on the way back with a 3 m long gravity corer (GC687). The sediments near the seafloor surface at this location, however, consist of greenish brown, muddy gravelly sand and consequently only a ~0.2 m long sediment core was retrieved.

Grounding Zone Wedge (GZW) in mid-shelf part of Anvers Trough: The next coring target was a GZW in the mid-shelf part of Anvers Trough. Two gravity and one box core (GC688/BC689/GC690) were recovered from the top of the GZW which is characterised by subglacial lineations undisturbed by iceberg scouring. BC689 was a successful deployment while the 6 m long gravity core GC688 recovered ~5.2 m of sediment but over-penetrated the seabed. The redeployment of the 9 m long core GC690 at the same site retrieved ~6.1 m of sediment with a gray soft muddy diamicton at its base. The 6 m long gravity cores GC691 and GC692 were successfully deployed at lineated seafloor directly seaward of the GZW and recovered ~4.1 m and ~4.7 m of sediment, respectively, with gray soft sandy to gravelly and muddy diamicton in the basal parts of the cores. Box core BC693 was then retrieved from site GC692. Site GC691 is located in proximity to the GZW in an area with a deep subbottom reflector visible in the TOPAS profiles while site GC692/BC693 is located a little further offshore at the pinch-out of this subbottom reflector. Later during the cruise, another 9 m long gravity corer (GC702) was deployed seaward of the GZW and retrieved ~4.9 m of sediment with a gray soft diamicton in its basal part. The 9 m long gravity cores GC694 and GC695 were deployed landward of the GZW in the mid-shelf part of Anvers Trough and both recovered ~5.3 m to ~6.7 m of gravelly sandy muds at their bases. GC694 was retrieved from

a medial ridge (medial moraine?) whereas site GC695, from which box core BC696 was also collected, is located in a seafloor depression slightly further south.

GZW-like terraced feature in mid-shelf part of Anvers Trough: The next coring target in the mid-shelf part of Anvers Trough was a GZW-like feature with a terraced front, which is located upstream of the GZW described above. Two 9 m long gravity cores (GC697 and GC698) were deployed on the top of the lower terrace and a depression located landward of the feature, respectively. The cores recovered ~7.3 m and ~6.3 m of sediment with a soft gray mud at the base. In order to recover undisturbed seafloor surface sediments box core BC699 was deployed at site GC698. The terraced GZW-like feature was revisited later during the cruise to retrieve a 9 m long gravity core (GC709) and a box core (BC710) from the top of its upper terrace. The gravity corer recovered ~3.6 m of sediment with a gravelly sandy mud at its base, while the box core surface was partly disturbed. In addition, a 9 m long gravity core (GC711) was deployed offshore from the lower terrace and recovered a ~5.9 m long sequence with a gray muddy diamicton at its base (shear strength: 25 kPa).

Eastern and western margins of Anvers Trough: In order to investigate the lithology, sedimentology and physical properties characterising the sediments at the margins of palaeo-ice stream troughs, a 6 m long gravity corer (GC700) plus a box corer (BC701) were deployed at the eastern margin of the mid-shelf part of Anvers Trough, seaward of the GZW. Core GC700 recovered ~1.8 m of sediment with a gray gravelly sandy mud at its base. Two other 9 m long gravity cores plus box cores (GC712/BC713 and GC714/BC715) targeted the eastern margin north of the terraced GZW-like feature and south of the GZW, respectively. Core GC712 recovered ~4.0 m of sediment with a gray muddy diamicton at its base (shear strength: 28 kPa) and GC714 recovered a ~2.3 m long sequence with a soft gray muddy diamicton at its base. Later during the cruise, another 9 m long gravity corer (GC716) was deployed in the eastern half of the mid-shelf part of Anvers Trough (just WSW of site GC700/BC701) and recovered ~4.1 m of sediment with a soft diamicton at its base. The western trough margin offshore from the GZW was targeted with a 9 m long gravity corer (GC703) and retrieved ~3.9 m of sediment with a gray stiff diamicton at its base (shear strength: 33 kPa).

Eastern tributary of Anvers Trough (middle shelf): An eastern tributary feeding north of the GZW into the mid-shelf part of Anvers Trough was the target for two coring sites. The 9 m long gravity core GC717 together with the box core BC718 targeted the western flank of the tributary while the 9 m long gravity core GC719 with box core BC720 targeted its eastern

flank. GC717 recovered ~6.1 m of sediment with a gray soft gravelly sandy mud at its base (shear strength: 8 kPa), while GC719 retrieved a ~3.9 m long core with a gray very soft mud at its base (shear strength: 1 kPa). The deployment of the box cores BC718 and BC720 at these sites was only of limited success because the sediment surface in both cores was very uneven indicating moderate to heavy disturbance during coring.

Outer shelf part of Anvers Trough: The coring targets on the outermost shelf in Anvers Trough comprised a previously mapped large-scale seafloor depression offshore from another GZW (GC704/BC705), a newly mapped smaller depression nearby (GC708) and a shelf area with a flat and smooth surface reflector in TOPAS profiles (GC706/GC707). The 9 m deployment at site GC704 retrieved ~4.2 m of sediment with a gray diamicton at the base and the 6 m deployment at site GC708 recovered ~4.3 m of sediment with a soft gray diamicton at its base (shear strength: 24 kPa). The 3 m long gravity core GC706 recovered ~2.4 m of sediment with gray gravelly sandy mud at its base. Although no obvious sign for over-penetration was found in core GC706, sediment completely filled the liner so it was decided to redeploy a 6 m long gravity core (GC707) at this location. The redeployment retrieved only ~0.8 m of sediment with a gray stiff diamicton at its base (shear strength: 59 kPa).

6. List of Scientific Equipment Used

6.1 Echo Sounders

Kongsberg Simrad EM122 multibeam echo sounder

Kongsberg Simrad TOPAS PS018 sub-bottom profiler

Kongsberg Simrad EA600 (Bridge navigational echo sounder)

Kongsberg Simrad sonar synchronisation unit (SSU)

6.2 Oceanographic instruments

Seabird Conductivity-Temperature-Depth (CTD) system, also including oxygen sensor, fluorometer, transmissometer, PAR sensor and altimeter

BAS Oceanlogger, including thermosalinograph, fluorometer, uncontaminated seawater intake thermometer, air temperature thermometer, anemometer, barometer, humidity sensor, PAR sensor and TIR sensor

6.3 Winches and wire monitoring

30-tonne traction winch, ship's conducting cable and CLAM wire monitoring system

Hydrographic wire, 10-tonne traction winch and CLAM wire monitoring system

6.4 Coring equipment

IceSheets/Chemistry and Past Climate gravity coring system

BAS Box corer (manufactured by Duncan & Associates; 300 mm square box)

6.5 Potential Field Equipment

Shipboard three-component magnetometer (STCM) with Bartington fluxgate sensors

6.6 Navigation

Seatex Seapath 200 (input to EM122 and TOPAS)

Furuno GP-32 GPS receiver

Ashtech GG24 GPS+GLONASS receiver

Ashtech GDU-5 3D GPS receiver (used as source for positional data in web logsheets)

TSS300 heave, roll and pitch sensor

Chernikeeff Aquaprobe Mk5 electromagnetic speed log

Sperry Doppler speed log

Gyro

6.7 Data Logging

NOAA Scientific Computer System (SCS) system

7. Equipment Performance

7.1 EM122 multibeam echo sounder

Kelly Hogan, Rob Larter, Christine Batchelor, Alex Tate, Eleanor Gowland

Logging of EM122 data was initiated at 1504 (UTC time) on JD005 as the JCR left Rothera. The system was operational at virtually all times the vessel was in motion; logging was stopped at 0432 on JD 018 in the Drake Passage at the edge of Argentina's exclusive economic zone (200 nautical miles from coast) on transit to Punta Arenas.

The EM122 performed reasonably well during the cruise with the exception of times when the vessel had a heading such that the wave/swell direction was on to either the port or starboard bow. In such conditions the ship's motion over the waves or swell results in aeration at the transducer array and the outgoing pings from the EM122 are either not transmitted into the water column, or are not received back by the receivers. This results in numerous ping dropouts and poor coverage of the seafloor. As such, tracklines were orientated into or out of the swell/wave direction when heavy seas were encountered. This was the case for surveying in the eastern part of Anvers trough on the mid-shelf and on the outer shelf in Anvers Trough. Dropouts resulting from missed individual pings or groups of pings, which have been noted on previous cruises (e.g. JRtri006, JR244), did not occur during JR284. The SSU unit crashed once and its display "froze" once during the cruise resulting in small along-track gaps in the multibeam coverage; however, these issues were easily resolved by manually re-booting the sonar and control interface.

7.1.1 EM122 settings during JR284

The EM122 was initialised using the settings laid out in the BAS document "Using the EM122 on an Opportunistic basis" by Buys and Tate in 2011. With this setup the EM122 was synchronised with the EA600 through the SSU with a calculated ping cycle based on the water depth. The width of the swath was set to a level appropriate for the water depth and weather conditions. Under favourable conditions beam angles were typically set to 65° on the port and starboard sides, although rarely this was increased to 68°. Beam angles were reduced if the outer beams became noisy or did not return a sounding, or if the EM122 had problems fixing the bottom. Minimum and maximum depths were set as appropriate for the bathymetry on the western Antarctic Peninsula shelf. During heavy seas, when the EM122 had trouble picking the seafloor reflector, both the beam angles and the min./max. depth parameters were

narrowed significantly to help the sonar locate the seafloor. For jr284_a and jr284_c surveys the Ping Mode was set to AUTO; the Ping Mode was set to either MEDIUM or AUTO for jr284_b as was recorded in the shipboard event logs.

Sound velocity profiles, derived from XBT and CTD casts during this cruise, as well as XBT casts carried out on previous JCR cruises, were changed as necessary for the water structure of the survey areas (cf. Table 1). A summary of the settings used for the EM122 during JR284 is presented in Appendix A4.1.

Reference

BUYS, G. and TATE, A. J., 2011. Using the EM122 on an Opportunistic basis. BAS Internal Document, pp. 1-9.

7.2 TOPAS sub-bottom parametric profiler

Kelly Hogan, Rob Larter, Christine Batchelor, Alex Tate, Eleanor Gowland

The TOPAS sub-bottom profiler performed very well during cruise JR284. Logging of TOPAS data began at 1738 (UTC) on JD005 and continued near-continuously until 0108 on JD0017. TOPAS data was not logged when the vessel was stationary at coring/CTD stations. The thermal plotter, which is linked to the TOPAS unit, also behaved reasonably well. Issues with the plotter arose only when it was accidentally switched off at the wall (JD010) and when the printer crashed (JD013); however, restarting the printer and the TOPAS software solved these problems fairly easily.

7.2.1 TOPAS settings during JR284

Typical parameter settings on the control workstation are listed in Appendix A4.2. Cruise JR284 surveyed almost exclusively in shelfal water depths less than about 600 m. As such, the TOPAS was setup in a synchronised mode with an external trigger from the SSU. The TOPAS trigger was set to either “calculated” or “Tx pulse” on the SSU unit. “Tx pulse” results in more frequent pings for both TOPAS and the EM122 but can also lead to the EM122 picking interference from the TOPAS ping as the seafloor return. The trigger was set to “Tx pulse” for the majority of the cruise to improve the resolution of the recorded data but it was occasionally switched to “calculated” if interference from TOPAS was leading to bad depth picks on the EM122 (e.g. on JD013).

The TOPAS system was operated using a chirp source for the entirety of the cruise, with a signal strength of 90-95%. The bottom tracker was used and a time-variable gain (TVG) applied to the data from the reflector identified as the seafloor by the bottom tracker. Small adjustments to the acquisition gain (typically 11-14 dB) were used to improve imaging of the sub-seafloor on the screen display and the analogue plotter.

7.3 EA600 echo sounder

The Kongsberg EA600 12 kHz echo sounder, the control console for which is located on the Bridge, was used for navigational purposes. Depths recorded by the system were all calculated using a constant assumed acoustic velocity of 1500 ms^{-1} and were logged on the NOAA SCS logging system. For most of the cruise the EA600 was triggered by the SSU, synchronized with the EM122, and operated in 'passive' mode, with the EA600 calculating its depth from the EM122's first return.

7.4 Gravity corer

Claus-Dieter Hillenbrand, James A. Smith, Scott Polfrey, Matthieu Cartigny, Ove Meisel

The BAS gravity corer (Fig. 1) was built in 2010 by P. Smit (Netherlands) for the *Palaeo-Ice Sheets* and *Quaternary Sediments* work packages at BAS and was used in the Antarctic on cruises JR244 in 2011 and JR257 in 2012. Set-up, deployment and recovery procedures of the gravity corer during cruise JR284 followed those on cruise JR257 and are given in the following (with modifications where applicable).

7.4.1 Gravity corer set up

The 12 m long corer cradle (aluminium framework), core bucket and davit winch were installed outboard of the ship's rail on the starboard side of the vessel using the ship's crane. The rack for the corer barrels and liners, and handling trestles were installed on the aft deck and on the starboard deck, respectively. The BAS gravity corer utilises a combination of 3 m- and 6 m long steel barrels together, the top end of which is nailed to a bomb weight. Only 3 m, 6 m, and 9 m barrel configurations were deployed during JR284. Inside the barrels pre-marked core liners (taped together for 9 m deployments and with arrows pointing up and labelled at 1 m intervals from A1 to A6 and B1 to B3, depending on the configuration and length of the barrels deployed) were inserted with a retaining valve (steel type) inserted at the

top of the liner closest to the bomb and a core catcher inserted at the bottom of the lowermost liner, followed by attachment of a core cutter to the lowermost barrel. The same core cutter (short version) and core catcher (with stiffness 'BC' on a scale from 'A' to 'K', whereby core catcher 'K' is the stiffest) were used throughout cruise JR284.



Figure 6. Preparation of the BAS gravity corer for a 9 m-deployment on cruise JR284. (Photo: Christine Batchelor).

7.4.2 Deployment and recovery

The complete corer assembly was lowered to the vertical position using the electric winch mounted on a davit, which is attached to the aft end of the corer cradle. The bomb weight retaining pin was removed and the corer was then lifted out of the bucket with the 10 ton crane. The corer was then transferred by crane to the core docking bracket mounted on the deck beneath (but slightly offset from the axis of) the mid-ships gantry. From here the winch cable was attached to the bomb and the corer was lowered to the seafloor. During cruise JR284, the veering speed of the gravity corer was 40 m/min and 50 m/min, respectively. In contrast to JR257, the corer was hauled immediately after penetrating into the seafloor but not left for two minutes to settle into the seabed. On recovery, the corer was placed back in the

docking bracket for the winch cable to be removed and the crane was then used to transfer the corer back into the cradle. Once the bomb was safely in the bucket with the retaining pin replaced, the cradle was then pulled back up to its horizontal position with the davit winch. The uppermost barrel was then disconnected from the bomb weight manually, using a wooden beam to support the weight and allow the adjoining barrel to slide off the collar of the bomb more easily. The barrel(s) were then transferred to the trestles for the liner(s) to be recovered and cut into 1 m long sections. End caps were placed on the base of each ≤ 1 m long section and sections were then transferred to the wet lab where they were cleaned. End caps were then placed on section tops and both end caps were thoroughly taped prior to all sections being labelled and stored in the cool store.

7.4.3 Problems/recommendations for changes

i) Docking bracket: The docking bracket is bolted to the deck in a position slightly offset to the axis of the mid-ships gantry, which hampers a quick transfer of the corer from the crane into the docking bracket. Shifting the position of the docking bracket directly under the mid-ships gantry is recommended. Moreover, the bracket should not be mounted directly to the deck but with underlying plates for each bolt.

ii) Barrels not fitting together: Barrels used on JR284 were problematic to fit together at the beginning of the cruise. Cleaning the rust from inside and outside of the joins was essential and testing them on the spare male and female barrel ends. It is recommended that the cleaning and testing is already carried out in the UK before the coring equipment is shipped onto a cruise.

iii) Transfer of the corer back into the cradle after deployment using the 10 ton crane: In contrast to cruise JR244, no ropes, strops or hooks were initially used on cruise JR284 to support the transfer. This practice caused delays, made coring impossible under conditions with significant swell and resulted, at least in one instance, in loss of a core cutter sample (the sediment dropped out when the corer heavily collided with the ship's hull). During the later part of cruise JR284, two ropes were attached to the top of the bomb enabling a faster and more accurate core transfer into the cradle. The recommendation here is that ropes should always be used, and it is also recommended that strops and hooks are used to support the transfer of the corer barrel(s) into the cradle with the crane. Moreover, it is required that two people always hold the end of core barrels when they are lifted with the crane in a horizontal

position out of the cradle and moved inboards onto the trestles (and the other way round) in order to prevent them from swinging.

iv) Strong wind and swell: Bad weather prevented deploying the gravity corer on ca. 1.5 days during cruise JR284.

v) Heavy sea-ice coverage and sea-ice drift: These factors prevented deployment of the gravity corer at two pre-selected sites in outer Marguerite Trough.

vi) End caps: New end caps had been ordered for cruise JR257, which were also used on cruise JR284. In comparison to the end caps used on JR244, the new end caps were more difficult to put onto the liner sections, even when bathed in warm water. The best practice for fitting the caps onto the liner sections was to put them into very hot water and using a nail rather than a cable tie under the rim of the cap to allow air to escape when fitting them onto the liner sections.

vii) Recovery rates: On cruise JR284 a total of 104.60 m of sediment cores was recovered at 26 gravity corer stations. The recovery rate (i.e. the ratio of core recovery to penetration depth) was calculated (i) only for the 20 stations with a reliable estimate of the penetration depth (i.e. the top of sediment smeared to the barrel was clearly visible), (ii) by taking into account the actual liner lengths (2.70/5.40/8.10 m) for the various barrel deployments (3/6/9 m), and (iii) by assuming only full liner penetration at stations where over-penetration was obvious from sediment smeared to the core bomb. The average gravity corer recovery rate for cruise JR284 was 72.5% (60.8% for four 3 m deployments, 71.2% for seven 6 m deployments and 78.7% for nine 9 m deployments). Thus, the total recovery rate was significantly higher than during cruise JR244 (47.8%), and the trend of higher recovery rates for longer barrel deployments seems opposite to the trend observed during JR257 (recovery rates >80% for 6 m deployments, >70% for 9 m deployments and significantly lower recovery rate for >12 m deployments). However, it needs to be taken into account that no 3 m deployments but numerous 12 m deployments were undertaken during cruise JR257, while several 12 m deployments were undertaken during cruise JR244. The recovery rates of the BAS gravity corer achieved during cruise JR284 are comparable to those of other gravity coring systems (54.3-69.9%, see cruise report JR244 for details). Nevertheless, it is recommended here that the recovery rates for the BAS gravity corer are carefully monitored, especially for ≥ 9 m deployments.

7.5 Box corer

Claus-Dieter Hillenbrand, James A. Smith, Scott Polfrey, Matthieu Cartigny, Ove Meisel

The BAS box corer (BC; box dimensions: 30 cm x 30 cm x 95.5-97.5 cm) was used during cruise JR284 to recover undisturbed surface sediments from the Antarctic Peninsula continental shelf. The BC had been deployed on earlier cruises (e.g. JR104, JR141, JR179, JR244, JR257; see corresponding cruise reports). During cruise JR284 the BC was deployed at 13 sites. At each deployment the BC triggered on reaching the seafloor, its spades closed (almost) completely and sediment was recovered. The subcores taken from each box core recovered ~2.8 m of sediment in total, with the length of subcores ranging from ~0.1 to ~0.3 m. In general, however, the box corer's performance was only satisfactory.

A problem encountered during JR284 (and during previous cruises) was that the box corer occasionally fell over when reaching the seafloor. When this occurred, the recovered sediment surface was significantly inclined (hampering or even preventing the sampling of subcores) but usually intact (e.g. BC685, Fig. 1). At other box core sites, especially during the second half of the cruise, the recovered sediment surface was very uneven and at least partly disturbed (e.g. BC720, Fig. 2). This issue often made it difficult to identify undisturbed seafloor surface sediments. Occasionally the surface sediment could only be identified by its brownish colour (when compared to the greyish to greenish colour of sub-seafloor sediments, see Fig. 2), which probably results from oxidisation at the seawater-seafloor interface.



Figure 7. Heavily inclined seafloor surface (upper part of the photo) in box core BC685. (Photo: Claus-Dieter Hillenbrand).



Figure 8. Very uneven, partly disturbed seafloor surface in box core BC720. (Photo: Claus-Dieter Hillenbrand).

As on previous cruises (e.g. JR244) the sampling of the box corer remains difficult. The height of the box and its small area make it difficult to access the sediment surface, particularly when core recovery is low. A recurrent problem is that the drainage of excess seawater using the siphoning tool (“octopus”) is very time consuming and, when swell is significant, inefficient. At one site during cruise JR284, water drainage was accelerated by opening a small gap between the spades, and whilst this led to faster drainage it also resulted in partial disturbance of the box core surface.

On cruise JR284 liners with a relatively small diameter of 57 mm and with very well fitting end caps (originally acquired for cruise JR257) were used for taking subcores from the box cores. This improvement allowed an easier and faster sampling of subcores than on other cruises (e.g. JR244), when liners with a larger diameter had been used. At most box core sites on cruise JR284 subcores were taken by pushing a 1 m long liner segment into the sediment and closing it with a perforated end cap. The spades were then opened and the subcore was pushed downwards through the box, with the hole in the end cap covered. As soon as the base of the liner segment appeared below the box, it was closed with another end cap, and the liner segment was then pulled out from above.

7.6 Cable Logging and Monitoring (CLAM) system

The CLAM system was used for monitoring the amount of wire out, hauling and veering rates and wire tension during gravity corer, box corer and CTD deployments. The system performed well throughout the cruise.

7.7 CTD system

A Conductivity-Temperature-Depth (CTD) unit and 24 bottle rosette was used to vertically profile the water column. Just two casts were carried out during the cruise, for the purpose of obtaining reliable sound velocity profiles for input to the EM122 system. The system performed well.

CTD positions are included in Appendix 3. Additional measurements on JR284 included a fluorometer, an oxygen sensor, a photosynthetically active radiation (PAR) sensor, a transmissometer and an altimeter.

7.8 Expendable bathythermograph (XBT) system

Type T7 XBT probes were deployed on JD008 and JD017 to provide sound velocity profiles for input to the EM122 system. The deployment positions are included in Appendix 3. The PC-based system that logs the data from the probes performed well.

7.9 Oceanlogger

The Oceanlogger was used during the cruise to monitor changes in surface water properties that could affect sound propagation, and hence indicate when it might be necessary to change the SVP being used by the EM122 multibeam echo sounder.

The flow of uncontaminated sea water that is required by the Oceanlogger was interrupted at times during the first few days of the cruise when the filters became clogged by ice. The water properties logged on the SCS system and included in the General Science and EM122 weblogs during these periods are unreliable.

7.10 Shipboard Three-Component Magnetometer (STCM)

The STCM ran throughout the cruise, but was not closely monitored. Data are still logged only on the dedicated PC from which the system is controlled, so data downloads have to be taken from this PC.

7.11 Navigation Systems

7.11.1 Seapath 320 System

This combined GPS and motion reference unit provides navigational data for the Kongsberg EM122 multibeam and TOPAS sub-bottom profiler systems. In some previous seasons differential corrections were obtained from a Racal Skyfix unit via an Inmarsat feed and applied in real time by the GPS receiver. However, the subscription to the Skyfix service has been discontinued, so differential GPS data were not available during this cruise. Data from this unit were logged onto both the Kongsberg EM122 system and the NOAA Scientific Computing System (SCS).

7.11.2 Furuno GP-32 GPS Receiver

This GPS receiver is located on the Bridge and used primarily by the deck officers. The

position fixes from the unit were logged to the NOAA SCS.

7.11.3 Ashtech GG24 GPS/GLONASS Receiver

This was operated throughout the cruise and position fixes calculated by this system were logged to the NOAA SCS.

7.11.4 Ashtech GDU-5 3D GPS and TSS300 Systems

These instruments provide heading, pitch, roll and heave information. Data from both systems were logged to the NOAA SCS. Positional data from the Ashtech GDU-5 was used in the web logsheete.

7.12 NOAA Shipboard Computing System

Since the summer of 2000, the main shipboard data logging system on *JCR* has been a Windows-based system provided by the U.S. National Oceanic and Atmospheric Administration (NOAA), called the Scientific Computer System (SCS). The SCS program allows data to be logged centrally on a server featuring RAID disk tolerance. Time stamping of data is achieved by synchronising to a GPS receiver. The SCS is also a NTP server which allows other machines onboard to synchronise their time.

Data on the SCS system is stored in two formats:

RAW data written to disk in exactly the same format it was sent from the instrument.

ACO ASCII Comma Delimited, data is stored in plain ASCII text.

Once data are being logged to disk, a process can be run on the unix server 'jrub' that reads the ACO files and writes data to the "rvs" Level C database in near real time. The "rvs" software can still be used to allow scientists to use existing routines to extract data, although some scientists now use MATLAB scripts to extract data directly from the ACO files.

The following data streams were logged to the SCS during JR284:

Stream name	Data Source
anemometer	Anemometer
ashtec	Ashtech 3D GPS
dopplerlog	Sperry doppler speed log (water speed)
ea600	Kongsberg Simrad EA600 single-beam echo sounder (12 kHz)
em122	Kongsberg Simrad EM122 multibeam echo sounder (12 kHz)
emlog	Chernikeeff Aquaprobe Mk5 electromagnetic speed log

furuno	Furuno GP-32 GPS Receiver
glonass	Ashtech GG24 GPS/GLONASS Receiver
gyro	Gyro
oceanlogger	Oceanlogger
seatex	Seapath combined differential GPS and motion reference unit
tsshrp	TSS300 heave, roll and pitch sensor
winch	Cable Logging and Monitoring (CLAM) System

During the cruise it was noticed that the EM122 centrebeam depths logged on the SCS are 6 to 7 metres less than those reported by the EM122 itself. The probable cause of this discrepancy is that the depths in the data stream being logged by the SCS are not corrected for the ship's draft.

8. ICT and AME reports

8.1 ICT report

Johnnie Edmonston

04/01/2014 1651 Acquisition started

07/01/2014 0909

1. SCSstopped logging
2. Heavy usage by users on jrlb caused samba to "hiccup", terminating the samba connection from the SCS for long enough for it to stop logging.
3. The reason for the hiccup didnt become apparent until later that day, users requested not to use jrlb for working on, in this case producing grids with mb.
4. JRUI, jrhc and jrld, all capable of running MB

07/01/2014 0924 scs reaquiring data

12/01/2014

1. Ashtec compress stream stalled.
2. recreated all compress streams.
3. restarted rvs streams on request of PSO

17/01/2014

1. JRNA hung, same problem as reported by jpro / aeng previously
2. jrna power cycled, still didnt boot.
3. Tape drive power cycled, jrna booted successfully.

20/01/2013 1413

1. end of cruise backups started

8.2 AME report

N.B. This report encompasses AME work on four cruises, including JR284

Cruises:JR291/292/312/284 Start date:11/10/2013 Finish date:20/01/2014

Name of AME engineer: Julian Klepacki

Names of principle scientists (PSO): S. Fielding(JR291), M. Maqueda(JR292), A. Tate(JR312), R. Larter(JR284)

LAB Instruments

Instrument	S/N Used	Comments
AutoSal		
Scintillation counter		
Magnetometer STCM1	Y	Display failed on power-up. Replacement fitted.
XBT	Y	

ACOUSTIC

Instrument	S/N Used	Comments
ADCP	Y	
Hydrophone		
EM122	Y	
TOPAS	Y	Believe first real use since upgrade? No probs.
EK60	Y	Main processor PC failed, ICT rebuilt machine
SSU	Y	
USBL	Y	Tracking DWNM, See notes, fitted video splitter
10kHz IOS pinger		
Benthos 12kHz pinger S/N 1316 + bracket		
Benthos 12kHz pinger S/N 1317 + bracket		
MORS 10kHz transponder		
Benthos UDB9000	Y	Attempted MCal calibration, see notes.
Hull Transducer	Y	Mooring work, created patch-cables, see notes.

OCEANLOGGER

Instrument	S/N Used	Comments
UIC		
Ocean Logger PC	Y	
Ocean Logger Interface	Y	
Barometer1	#V145002	
Barometer2	#V145003	
Foremast Sensors		
Air humidity & temp1	#60599569	
Air humidity & temp2	#60599557	
TIR1 sensor (pyranometer)	#112993	
TIR2 sensor (pyranometer)	#112992	18/12/2013 fault with sensor package wiring
PAR1 sensor	#110127	
PAR2 sensor	#110126	
Prep Lab		
Thermosalinograph SBE45	#4524698-0018	
Transmissometer C-STAR	CST-396DR	
Fluorometer	Y	
Flow meter	#11950	
Transducer Space		
Uncontaminated seawater temp	Y	Removed 20/12/2013
SBE38 Seawater Temp	#0501	Fitted 20/12/2013 see notes
SBE38 Seawater Temp	#0599	Fitted 20/12/2013 see notes

CTD (all kept in cage/ sci hold when not in use)

Instrument	S/N Used	Comments
CTD PC	Y	CTD PC1
Deck unit 1 SBE11plus	#-0458	
Underwater unit SBE9plus	#-0707	
Temp1 sensor SBE3plus	#03P4472	
Temp2 sensor SBE3plus	#03P2366	
Cond1 sensor SBE 4C	#04C2222	
Cond2 sensor SBE 4C	#04C2289	
Pump1 SBE5T	#4488	
Pump 2 SBE5T	#3415	
Standards Thermometer SBE35	#3527735-0024	
Transmissometer C-Star	CST-846DR	
Fluorometer Aquatraka Mk3	#088-216	
Oxygen sensor SBE43	#2290	
PAR sensor	#7235	
Altimeter PA200	#244740	No signal, constant at 100m; cast #003, stn026
Altimeter PA200	#163162	Fitted 01/12/13, replaces #244740, works o.k
CTD swivel+ linkage	#196111	
Carousel + 24 Bottle Pylon	#0636	
Notes on any other part of		Megohm testing sea-cable does not fail, but

CTD e.g. faulty cables, wire drum slip ring, bottles, swivel, frame, tubing etc		gives worryingly low values of resistance, but works fine. A number of deep casts performed ~4k and no errors etc. See notes
---	--	--

LADCP

Instrument	S/N Used	Comments
300KHz WH Monitor	15060	
300KHz WH Monitor		
Battery Pack	Y	
Charger	Y	
Cables	Y	A comms cable into chem-lab appears faulty
AME Laptop (BBTalk)	Y	

MISC

Instrument	S/N Used	Comments
NMEA Server	Y	Fitted display repeater for UIC + workshop displays, See Notes
LabView Server	Y	See notes
DWNM PC (acoustic st'n)	Y	

AME UNSUPPORTED INSTRUMENTS BUT LOGGED

Instrument	Working?	Comments
EA600	Y	
Anemometer	Y	
Gyro	Y	
DopplerLog	Y	
EMLog	Y	
Seapath 320+	Y	

INTAKE FAN CLEANING

Instrument	Cleaned?
Oceanlogger	N
EM122, TOPAS, NEPTUNE UPSs	N
Seatex Seapath	N
EM122 Tween Deck	N
TOPAS Tween Deck	N

Additional notes and recommendations for change / future work

N.B. The original version of this AME report included several sub-sections of notes and recommendations that relate to instruments not used on JR284, and those sub-sections are not reproduced here.

Ocean Logger

Configured new sbe38 temperature sensors to RS485 comms, each with their individual ID and tested on the bench with a nudam + Advantech converters, all working. This will allow the two sensors to be simply patched into the existing wiring for the industrial pt100 sensor, using two of it's wires as the rs485 bus. A simple 'polling' instruction added to the O.L.

During the Stanley call the SBE38's were installed. Instrument pockets were filled with antifreeze to bleed the pockets of air and provide a better thermal interface to the temperature sensor.



Figure 9. The support bracket needs to be rectified. It is out of alignment when the sensors are fitted and you cannot tighten it properly without adding stress to the installation. The support wants cutting off, and re-welding with everything bolted up leaving a slight gap between the flat-bar and strut it bolts too, to allow fitting of a rubber-shim to give some dampening/tolerance.

The SBE38 supply range is 8-15Volts and 10mA average. O.L supply-bus is 24V originating from the computer-logger interface. An interim 15V regulator circuit was fitted inside the Gravity-meter room O.L. enclosure to step the voltage down. This wants replacing with a DCDC converter appropriately filtered and mounted inside the enclosure. The O.L. program was modified to implement the new instruments, some additional delays were required to synchronise data polling. The O.L. program sends a global instruction to take a sample (actually average of 4 samples). This is picked up by SBE38 pair, so they sample simultaneously, then, 'Read' commands are sent to get the values from the each SBE38. The O.L program wants an overhaul, some aspects of it are written in an over-complicated manner with many sub-vi levels.

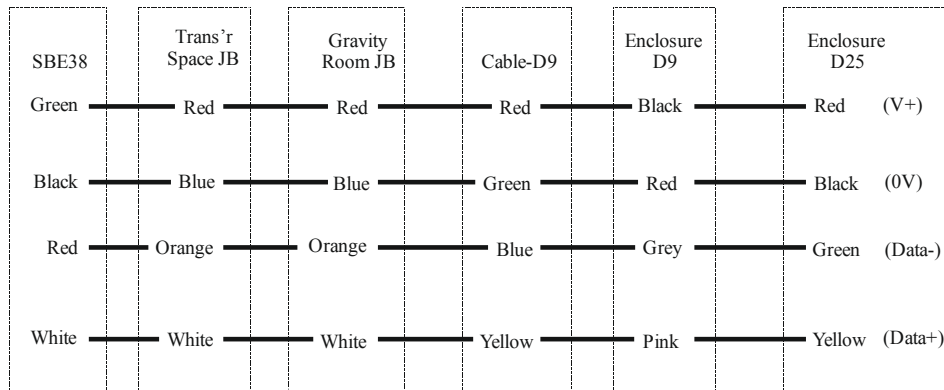

Figure 10. SBE38 wiring schematic

Fluorometer Read-errors; Historically the O.L. program has had problems reading the fluorometer data. The fluorometer data string is output from the instrument every 5 seconds (doesn't work at faster speeds, should be better?) and is not erroneous at all if you monitor it with a terminal program etc. The O.L. program simply reads the serial port the fluorometer is connected to (comm10) and extracts, converts the data. Errors appear when 'part' data strings that do not include expected data are read. So program outputs 'NaN' in those instances. Part-strings are not output from the fluoro' itself, they are always a consistent complete string. Likely a part read from the O.L, buffer over-run etc? Monitoring serial read error-out status shows another error, but it is not clear what the problem is as data looks unaffected?

At one point the SCS O.L monitor was showing frequent errors with the O.L file and the O.L itself was running very 'clunky' with machine time erratically updating and long periods (many seconds) of it hanging. I re-wrote the subvi that reads the fluorometer, simplifying it somewhat and appeared to eliminate the 'part-strings'? Errors were reduced, but not eliminated.

The O.L. continues to accumulate read errors on the fluoro and barometer2 now. I believe it is because of serial-read-timings. Over time as new instruments have been added the serial read section of code has become convoluted and needs to be rewritten. Small traps have been placed in the code so not to disturb the plots and data logging. Basically using the last known good value in the event of a read error. The number of errors accumulating are simply monitoring of the read process and do not represent bad quality or erroneous data.

O.L. Cont. 18/12/2013: The O.L. blew a fuse on the 24V DAQ-module/sensor supply circuit. Further investigation revealed that the foremost sensor package was pulling the supply voltage down significantly; measuring 20V at the foremost, dropping to ~5V when the sensor package was plugged in. Also the TIR2 Nudam, ND-6011D module shunt resistors was damaged, burnt and only measured 7.5Ω instead of the nominal 125Ω. With the damaged resistor removed supply voltage was maintained at 20V+. A 150Ω 0.1% resistor was fitted for diagnostic, on fitting the TIR2 ND6011 displayed the F.S. maximum 20.000mA and the resistor got very hot. A lot more than 20mA actually flowing, not measured, but I think it's likely to have the full 20+V supply across the resistor; $20/150 = 0.1333A$, $0.1333^2 \times 150 = 2.667$ watts. Max should be 60mW.

Concluded that the TIR2 amplifier box has become faulty and causing excessive current through the 4-20mA circuit. This excess current burnt out the 125Ω resistors(s), should only be 50mW maximum ($0.02^2 \times 125$). This excess supply current caused blowing the deck-unit fuse rated at 1A. The resistor was removed and the IN+ and IN- terminals were disconnected to isolate the TIR2 amplifier box circuit from power. Foremast sensor package, less the TIR2 is now operational. Faulty amplifier needs to be changed out for a spare next opportunity, likely

refit as it cannot be done realistically at the foremast. Amplifier boxes are ‘matched’ to the radiometer, so the correct spare needs to be installed. Spares are held on ships AME stock.



Figure 11. Burnt TIR2 ND6011 shunt resistor(s).

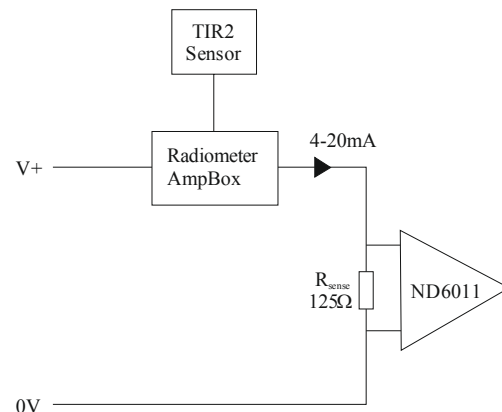

Figure 12. Radiometer Circuit.

The Amplifier boxes can be removed all together. Radiometer specifications state a cable length no greater than 100M before it is amplified etc. The top half of the foremast is only several meters high, so effectively a ‘run’ of a fraction of maximum specified. This way the output from the Radiometers can be fed directly into the Nudam DAQ modules at the top of the A-Frame, giving easy access in the event of diagnostics etc. Ideally amplifiers would be as close to the sensors as possible, but I think it will make negligible difference. This can be tested under laboratory conditions simulating long cable lengths with resistor values. Talking to Deck-Engineer, there is now a cable transit at the bottom of the foremast A-frame. I propose during refit to relocate all the O.L DAQ into the post-room and individually re-cable the foremast for sensors. All work can be carried out at deck-level then, other than replacing sensors by unplugging them at the top of the foremast.

Sea cable

30/12/2013		
VOLTS	Pre Clean MΩ	Post Clean MΩ
250	~35	~130
500	~16	~120
1000	~6	~120

JR291 CTDs had been carried out without any seacable/termination issues at all. The pre-clean values were taken after JR291, during JR312 /292 work and just prior to P.M. being carried out by Deck Engineer.

NMEAsplitter

The NMEAsplitter 1U PC has dual graphics capability with a single digital DVI and VGA outputs. The DVI output needs a DVI monitor attached to get dual capability. If you connect a VGA monitor through an adaptor, the PC won't see the DVI monitor and you won't get dual-capabilities. At present the PC has VGA output fed into a video-splitter, one of the dual output then goes into a kvm and can be directed to the AME workshop for ease of working on the PC, code changes etc. The other mirrors the display to a monitor fitted to the top of the cabinet for general display into the UIC. If this UIC monitor is replaced with a DVI monitor, the dual capabilities can be implemented and the video-splitter can be removed to simplify the cabinet internals somewhat.

LView Virtual Server

ICT have set up a virtual machine for running the LView Web-based programs in an attempt to solve the ongoing problem of distributing instrumentation over ships LAN with labview. A historical 'memory leak' problem with LView has been resolved with a newer version, but the LView PC in the acoustic cabinet still crashes when it is enabled as a Web Server.

The *NavMet* data display labview program has been updated to read the scs data more efficiently. Previously it simply read the *raw* files off the scs, this was placing a significant load on the server as reported by ICT. The program was changed to capture relative data from the broadcast over the network. This has removed the loading previously seen, but the machine still crashed when web-enabled. The new latest version of the VI on the machine is *NavMetWeb2013TCP.vi*.

A set of programs have been created for the virtual machine. Main program captures the data broadcast, checks validity and extracts most recent values. These values are then written to global variables for the other programs to display. This has minimal loading and by utilising a single data-capture it is easy to change, add or modify parameters

Implemented programs are found in *C:\LViewVis\GLOBAL*, on the virtual machine. They are also backed up on the AME *projects* folder. Also included is brief documentation describing programs and operation. Links have been added to the JCR homepage and programs have been running for many days without any major problems with continuous monitoring on a couple of remote machines. The odd bug becomes apparent, but can be dealt with as and when they materialise.

The Webserver programs seem fairly stable now, the odd hiccup, but on the whole work. Not sure about this virtual machine business, it's appears hassle being shut down here and there and not restarted etc. I think a physical machine again, but just much, much better than the 1U machine tried on initially Consultation with ICT to advise.

9. Acknowledgements

We thank Captain Chapman, the officers and crew of the RRS *James Clark Ross* for helping to make this short cruise a productive and enjoyable cruise. As on many previous cruises, the quality of support for the scientific programme from all of the ship's company was second-to-none.

Thanks are also due to many in the BAS Operations, Logistics and Personnel Sections for arranging for people and equipment to be in the right places at the right time and making sure all members of the scientific party were well prepared. We are particularly grateful to Chris Hindley for finding a way to make a late adjustment to the ship's itinerary that avoided making what was always going to be a very short cruise even shorter.

10. Acronyms

AME	BAS Antarctic Marine Engineering Section
AWI	Alfred Wegener Institute for Marine and Polar Research, Germany
BAS	British Antarctic Survey
BC	Box corer
CC	Core catcher
CLAM	Cable Logging and Monitoring system
CTD	Conductivity-Temperature-Depth
GC	Gravity corer
GPS	Global Positioning System
GZW	Grounding zone wedge
ICT	BAS Information and Computing Technology Section
IRD	Ice-rafted debris
JCR	RRS <i>James Clark Ross</i>
LGM	Last Glacial Maximum
MSGL	Mega-Scale Glacial Lineations
NMF	National Marine Facilities
NOAA	U.S. National Oceanic and Atmospheric Administration
NOC	National Oceanography Centre
SCS	Shipboard Computing System
SSU	Simrad Sequencing Unit
STCM	Shipboard Three-Component Magnetometer
SVP	Sound Velocity Profile
TOPAS	TOpographic PArametric Sonar
TVG	Time variable gain
UIC	Underway Instrumentation and Control room
USS	Uncontaminated seawater supply
XBT	Expendable Bathythermograph

11. Recommendations

Several recommendations for changes to the gravity coring system are made in section 7.4.3 of this report (starting on p28).

Appendix 1. Bridge Science Log

Time	Event	Lat	Lon	Comment
16/01/2014 21:18		-64.21196	-64.75861	Completed swathing in Anvers trough area
16/01/2014 19:36		-64.22016	-64.25443	Deck all secure completed loading coring equipment in container
16/01/2014 17:29		-64.22035	-64.25319	Frame recovered to stand
16/01/2014 17:18		-64.22036	-64.2532	Bomb recovered in stand
16/01/2014 17:12		-64.22034	-64.2532	Commence recovery of frame and bomb
16/01/2014 17:06	43	-64.22033	-64.25322	Box corer recovered
16/01/2014 16:53	43	-64.22036	-64.25319	Box corer clear of the seabed
16/01/2014 16:49	43	-64.22035	-64.25317	Box corer on the seabed
16/01/2014 16:33	43	-64.22032	-64.2532	Box corer deployed
16/01/2014 16:24	42	-64.22031	-64.25322	Corer recovered to frame
16/01/2014 16:15	42	-64.22035	-64.25321	Corer recovered to bucket
16/01/2014 16:02	42	-64.22032	-64.25317	Corer clear of the seabed
16/01/2014 15:58	42	-64.22031	-64.25318	Corer on the seabed
16/01/2014 15:46	42	-64.22029	-64.25317	Corer deployed
16/01/2014 15:34	42	-64.22032	-64.25316	Commence deployment of 9m gravity corer
16/01/2014 15:30		-64.22034	-64.25304	Vessel on station
16/01/2014 13:17	41	-64.24353	-64.5742	Box corer recovered to deck
16/01/2014 13:05	41	-64.24351	-64.5742	Corer clear of the seabed
16/01/2014 13:00	41	-64.24349	-64.57423	Corer on the seabed
16/01/2014 12:59	41	-64.24348	-64.57426	Corer 60m from the bottom
16/01/2014 12:45	41	-64.24347	-64.57427	Box corer deployed
16/01/2014 12:43	41	-64.24347	-64.57424	Commence deploying Box corer
16/01/2014 12:38	40	-64.24349	-64.57424	Corer recovered to the frame
16/01/2014 12:22	40	-64.24351	-64.57422	Corer in the bucket
16/01/2014 12:09	40	-64.24353	-64.57424	Corer clear of the seabed
16/01/2014 12:06	40	-64.24353	-64.57422	Corer in the seabed
16/01/2014 12:05	40	-64.24352	-64.57423	Corer 60m from the bottom
16/01/2014 11:54	40	-64.24355	-64.5742	Corer deployed
16/01/2014 11:44	40	-64.24355	-64.57421	Commence deploying 9m Gravity Corer
16/01/2014 11:36		-64.24352	-64.57419	Vsl on DP
16/01/2014 00:43		-64.26782	-65.14488	Deck all secure
16/01/2014 00:26	39	-64.26782	-65.14488	Corer recovered to frame
16/01/2014 00:13	39	-64.26783	-65.14485	Corer in the bucket
16/01/2014 00:00	39	-64.26784	-65.14481	Corer clear of the seabed
15/01/2014 23:56	39	-64.26784	-65.1448	Corer in the seabed
15/01/2014 23:55	39	-64.26783	-65.14482	Corer 60m from the bottom
15/01/2014 23:44	39	-64.26783	-65.14483	Corer deployed
15/01/2014 23:33	39	-64.26784	-65.14489	Commence deploying 9m Gravity Corer
15/01/2014 23:18		-64.26776	-65.14489	Vsl on DP
15/01/2014 22:12		-64.24113	-65.47972	Vessel off D.P
15/01/2014 22:11		-64.24138	-65.47947	Fetch buoy recovered
15/01/2014 22:10		-64.24165	-65.47896	Vessel on D.P to recover FETCH
15/01/2014 22:04		-64.24214	-65.47654	Grappled fetch buoy
15/01/2014 21:57		-64.24045	-65.47667	Vessel off D.P
15/01/2014 21:55		-64.24047	-65.47671	FETCH buoy sighted at the surface
15/01/2014 21:52		-64.24045	-65.47674	Hydrophone recovered
15/01/2014 21:45	38 (FETCH)	-64.24048	-65.47673	FETCH released from the seabed
15/01/2014 21:29		-64.24042	-65.47676	Hydrophone deployed to download data and release FETCH
15/01/2014 21:20		-64.23874	-65.47577	Hydrophone recovered
15/01/2014 21:15		-64.23867	-65.4757	Hydrophone deployed
15/01/2014 21:09		-64.23863	-65.47127	V/L on D.P
15/01/2014 20:26		-64.2795	-65.27442	Break from Swathing
15/01/2014 18:54		-64.29256	-64.90456	Vessel off DP
15/01/2014 18:41	37	-64.29446	-64.90255	Box corer recovered
15/01/2014 18:29	37	-64.29444	-64.90254	Box corer clear of the seabed
15/01/2014 18:25	37	-64.29444	-64.90252	Box corer on the seabed
15/01/2014 18:10	37	-64.29445	-64.90254	Box corer deployed
15/01/2014 17:56	36	-64.2944	-64.90253	Corer recovered to the frame
15/01/2014 17:44	36	-64.29445	-64.90253	Corer recovered to the bucket
15/01/2014 17:31	36	-64.29447	-64.90251	Corer clear of the seabed

Time	Event	Lat	Lon	Comment
15/01/2014 17:28	36	-64.29446	-64.90253	Corer on the seabed
15/01/2014 17:16	36	-64.29446	-64.90252	Gravity Corer Deployed
15/01/2014 16:54	36	-64.29443	-64.90253	Commence deployment of gravity corer
15/01/2014 16:42		-64.29415	-64.90161	Vessel on station
15/01/2014 01:03		-64.46823	-64.86989	Deck all secure
15/01/2014 00:50	35	-64.46822	-64.86986	Box corer recovered to deck
15/01/2014 00:36	35	-64.46821	-64.86985	Corer clear of the seabed
15/01/2014 00:33	35	-64.4682	-64.86985	Box corer on the seabed
15/01/2014 00:29	35	-64.46821	-64.86981	Corer 60m from the bottom
15/01/2014 00:17	35	-64.46822	-64.86985	Box corer deployed
15/01/2014 00:11	35	-64.46823	-64.86986	Commence deploying Box corer
15/01/2014 00:05	34	-64.46821	-64.86985	Corer recovered to frame
14/01/2014 23:53	34	-64.46823	-64.86987	Corer recovered to bucket
14/01/2014 23:39	34	-64.46823	-64.86985	Corer clear of the seabed
14/01/2014 23:37	34	-64.46825	-64.86985	Corer in the seabed
14/01/2014 23:36	34	-64.46823	-64.86986	Corer 60m from the bottom
14/01/2014 23:24	34	-64.46823	-64.86988	Corer deployed
14/01/2014 23:14	34	-64.46822	-64.86986	Commence deploying 9m Gravity Corer
14/01/2014 23:00		-64.46854	-64.87031	V/L on D.P
14/01/2014 21:25		-64.52735	-65.38139	Gantry and deck all secure
14/01/2014 21:11	33	-64.52738	-65.38138	Gravity corer fully recovered
14/01/2014 20:57	33	-64.52737	-65.38141	Gravity corer at the surface recovered in stand
14/01/2014 20:45	33	-64.52739	-65.38132	Gravity corer clear of the seabed
14/01/2014 20:41	33	-64.52738	-65.38136	Gravity corer on the seabed
14/01/2014 20:27	33	-64.5274	-65.38137	Gravity Corer Deployed
14/01/2014 20:23	33	-64.52739	-65.38145	Gravity corer in stand transferring weight to coring wire
14/01/2014 20:18	33	-64.52739	-65.38135	Commence deploying 9m Gravity Corer
14/01/2014 20:00		-64.52745	-65.38234	Vessel on D.P
14/01/2014 19:07		-64.6323	-65.31806	Gantry and deck all secure
14/01/2014 18:42	32	-64.63235	-65.31804	Box corer clear of the seabed
14/01/2014 18:38	32	-64.63233	-65.31799	Box corer on the seabed
14/01/2014 18:24	32	-64.63235	-65.31809	Box corer deployed
14/01/2014 18:14	31	-64.63235	-65.31804	Corer recovered to the frame
14/01/2014 18:08	31	-64.63233	-65.31801	Corer recovered to the bucket
14/01/2014 17:53	31	-64.63232	-65.31802	Corer clear of the seabed
14/01/2014 17:50	31	-64.63232	-65.31804	Corer on the seabed
14/01/2014 17:38	31	-64.63235	-65.31801	Gravity Corer Deployed
14/01/2014 17:16	31	-64.63231	-65.31811	Commence deployment of 9m gravity corer
14/01/2014 17:11		-64.63232	-65.318	Vessel on new position on DP
14/01/2014 16:54		-64.63184	-65.32281	Vessel on station on DP
13/01/2014 20:02		-64.63184	-65.32241	Vessel off D.P to resume SWATH survey
13/01/2014 19:36		-64.63242	-65.32335	Vessel on D.P
12/01/2014 22:05		-63.87686	-65.68959	Gantry and deck all secure
12/01/2014 21:57	30	-63.87688	-65.68959	CTD recovered on deck
12/01/2014 21:54	30	-63.87688	-65.68956	CTD clear of the water
12/01/2014 21:46	30	-63.87683	-65.68953	Wire out 460m
12/01/2014 21:34	30	-63.87685	-65.68957	CTD in the water
12/01/2014 21:28	30	-63.87684	-65.68955	Commence deploying CTD
12/01/2014 21:09	29	-63.87688	-65.68955	Gravity corer fully recovered
12/01/2014 20:58	29	-63.8769	-65.6896	Gravity corer at the surface recovered in stand
12/01/2014 20:46	29	-63.87688	-65.68959	Gravity corer clear of the seabed
12/01/2014 20:44	29	-63.8769	-65.68957	Gravity corer on the seabed
12/01/2014 20:33	29	-63.87688	-65.68961	Gravity Corer Deployed
12/01/2014 20:27	29	-63.8769	-65.68957	Gravity corer in stand transferring weight to coring wire
12/01/2014 20:22	29	-63.87688	-65.68954	Commence deploying 6m Gravity Corer
12/01/2014 20:12		-63.87763	-65.68795	Vessel on D.P
12/01/2014 16:30		-63.89973	-65.51218	Off DP
12/01/2014 16:09	28	-63.90105	-65.51375	Corer recovered to frame
12/01/2014 15:59	28	-63.90106	-65.51372	Corer recovered to bucket
12/01/2014 15:47	28	-63.90109	-65.51374	Corer clear of the seabed
12/01/2014 15:44	28	-63.90107	-65.51376	Corer on the seabed
12/01/2014 15:34	28	-63.90109	-65.51371	Corer deployed
12/01/2014 15:10	28	-63.90109	-65.51372	Commence deployment of 6m gravity corer
12/01/2014 15:00	27	-63.90109	-65.51375	Corer recovered to frame
12/01/2014 14:53	27	-63.90108	-65.51375	Corer in the bucket

Time	Event	Lat	Lon	Comment
12/01/2014 14:39	27	-63.90107	-65.51375	Corer clear of the seabed
12/01/2014 14:37	27	-63.90108	-65.51375	Corer in the seabed
12/01/2014 14:36	27	-63.90109	-65.51375	Corer 60m from the bottom
12/01/2014 14:26	27	-63.90108	-65.51377	Corer deployed
12/01/2014 14:13	27	-63.90111	-65.51374	Commence deploying 3m Gravity Corer
12/01/2014 14:02		-63.90202	-65.51334	Vsl on DP
12/01/2014 13:38		-63.88687	-65.51118	Vsl off DP
12/01/2014 13:31	26	-63.88686	-65.51113	Box corer recovered to deck
12/01/2014 13:17	26	-63.88683	-65.51117	Box corer clear of the seabed
12/01/2014 13:14	26	-63.88684	-65.51115	Box corer on the seabed
12/01/2014 13:12	26	-63.88683	-65.51119	Corer 60m from the bottom
12/01/2014 13:00	26	-63.8868	-65.51118	Box corer deployed
12/01/2014 12:56	26	-63.88681	-65.51122	Deploying Box Corer
12/01/2014 12:54	25	-63.88681	-65.51123	Corer recovered to frame
12/01/2014 12:44	25	-63.88685	-65.51119	Corer recovered to bucket
12/01/2014 12:31	25	-63.88687	-65.51112	Corer clear of the seabed
12/01/2014 12:28	25	-63.88686	-65.51124	Corer in the seabed
12/01/2014 12:27	25	-63.88685	-65.51118	Corer 60m from the bottom
12/01/2014 12:18	25	-63.88688	-65.51112	Corer deployed
12/01/2014 12:01	25	-63.88713	-65.51182	Commence deploying 9m Gravity Corer
12/01/2014 11:54		-63.88724	-65.51113	Vsl on DP
11/01/2014 20:42		-64.24338	-65.47745	Vessel off D.P
11/01/2014 20:41		-64.24339	-65.47745	Hydrophone recovered
11/01/2014 20:33		-64.24348	-65.47738	Hydrophone deployed downloading FETCH data
11/01/2014 20:31		-64.24342	-65.47732	Vessel on D.P at FETCH site
11/01/2014 20:04		-64.27153	-65.5924	Gantry and deck all secure
11/01/2014 19:42	24	-64.27669	-65.60355	Gravity corer fully recovered
11/01/2014 19:32	24	-64.27668	-65.60356	Gravity corer at the surface recovered in stand
11/01/2014 19:19	24	-64.27668	-65.60354	Gravity corer clear of the seabed
11/01/2014 19:16	24	-64.27668	-65.60352	Gravity corer on the seabed
11/01/2014 19:03	24	-64.27672	-65.60352	Corer deployed (9m)
11/01/2014 18:50	24	-64.27707	-65.60438	Commence deployment of gravity corer
11/01/2014 18:48		-64.27672	-65.60358	On station on DP
11/01/2014 17:54		-64.25422	-65.3717	Off DP
11/01/2014 17:34	23	-64.25457	-65.37182	Corer recovered to frame
11/01/2014 17:23	23	-64.25456	-65.37182	Corer recovered to bucket
11/01/2014 17:11	23	-64.25454	-65.37181	Corer clear of the seabed
11/01/2014 17:07	23	-64.25453	-65.37183	Corer on the seabed
11/01/2014 16:53	23	-64.25453	-65.37187	Gravity Corer Deployed
11/01/2014 16:43	23	-64.25431	-65.37189	Commence deployment of gravity corer
11/01/2014 16:42		-64.25444	-65.37233	On station on DP
11/01/2014 15:24		-64.21917	-65.0278	Off DP
11/01/2014 15:12	22	-64.21946	-65.02851	Box corer recovered
11/01/2014 14:59	22	-64.21949	-65.0285	Corer clear of the seabed
11/01/2014 14:55	22	-64.21947	-65.02853	Corer on the seabed
11/01/2014 14:52	22	-64.21948	-65.02851	Corer 60m from the bottom
11/01/2014 14:40	22	-64.21948	-65.02851	Corer deployed
11/01/2014 14:37	22	-64.21948	-65.02849	Commence deploying Box corer
11/01/2014 14:33	21	-64.21948	-65.02848	Corer recovered to frame
11/01/2014 14:27	21	-64.21948	-65.02848	Corer in the bucket
11/01/2014 14:10	21	-64.21949	-65.0285	Corer clear of the seabed
11/01/2014 14:06	21	-64.2195	-65.02847	Corer in the seabed
11/01/2014 14:05	21	-64.21951	-65.02845	Corer 60m from the bottom
11/01/2014 13:55	21	-64.21952	-65.02849	Corer deployed
11/01/2014 13:45	21	-64.21967	-65.02842	Commence deploying 6m Gravity Corer
11/01/2014 13:42		-64.21984	-65.02873	Vsl on DP
11/01/2014 00:27		-64.70011	-65.23339	Deck all secure
11/01/2014 00:18	20	-64.70011	-65.23338	Box corer recovered to deck
11/01/2014 00:03	20	-64.7001	-65.23338	Corer clear of the seabed
11/01/2014 00:01	20	-64.70011	-65.23338	Corer on the seabed
10/01/2014 23:59	20	-64.7001	-65.23336	Corer 60m from the bottom
10/01/2014 23:46	20	-64.7001	-65.23337	Box corer deployed
10/01/2014 23:43	20	-64.7001	-65.23339	Commence deploying Box corer
10/01/2014 23:34	19	-64.70009	-65.23337	Corer recovered to frame
10/01/2014 23:25	19	-64.7001	-65.23334	Corer in the bucket

Time	Event	Lat	Lon	Comment
10/01/2014 23:11	19	-64.70009	-65.23336	Corer clear of the seabed
10/01/2014 23:08	19	-64.70009	-65.23334	Corer in the seabed
10/01/2014 23:06	19	-64.70009	-65.23335	Corer 60m from the bottom
10/01/2014 22:55	19	-64.70008	-65.23335	Gravity Corer Deployed
10/01/2014 22:50	19	-64.70009	-65.23334	Gravity corer in stand transferring weight to coring wire
10/01/2014 22:45	19	-64.7001	-65.23335	Commence deploying 9m Gravity Corer
10/01/2014 22:28		-64.69986	-65.23295	Vessel on D.P
10/01/2014 21:38		-64.60503	-65.34338	Deck and grantry all secure
10/01/2014 21:28	18	-64.60504	-65.3434	Gravity corer fully recovered
10/01/2014 21:20	18	-64.60504	-65.34337	Bomb recovered in stand
10/01/2014 21:19	18	-64.60504	-65.34338	Gravity corer at the surface
10/01/2014 21:06	18	-64.60506	-65.34338	Corer clear of the seabed
10/01/2014 21:02	18	-64.60506	-65.34341	Corer on the seabed
10/01/2014 20:47	18	-64.60507	-65.3434	Corer deployed
10/01/2014 20:45	18	-64.60506	-65.34338	Crane disconnected
10/01/2014 20:43	18	-64.60506	-65.34339	Coring wire back on the sheaves
10/01/2014 20:34	18	-64.60507	-65.3434	Weight transferred to crane
10/01/2014 20:20	18	-64.60504	-65.34338	Coring wire jumped off the sheaves in winch room
10/01/2014 20:18	18	-64.60505	-65.34337	Weight taken on coring wire
10/01/2014 20:14	18	-64.60503	-65.34339	Gravity corer transferred to stand.
10/01/2014 20:10	18	-64.60504	-65.34338	Commence deploying 9m Gravity Corer
10/01/2014 19:54		-64.60418	-65.3432	Vessel on D.P
10/01/2014 18:54		-64.47378	-65.31303	Off DP proceeding to next station
10/01/2014 18:48	17	-64.47378	-65.31302	Box corer recovered
10/01/2014 18:32	17	-64.47379	-65.31298	Box corer clear of the seabed
10/01/2014 18:29	17	-64.4738	-65.31298	Box corer on the seabed
10/01/2014 18:13	17	-64.47376	-65.31299	Box corer deployed
10/01/2014 18:08	16	-64.47377	-65.313	Corer recovered to frame
10/01/2014 18:00	16	-64.47377	-65.31301	Corer recovered to bucket
10/01/2014 17:45	16	-64.47378	-65.31302	Corer clear of the seabed
10/01/2014 17:42	16	-64.47377	-65.31304	Corer on the seabed
10/01/2014 17:26	16	-64.47376	-65.3131	Corer deployed
10/01/2014 17:20	16	-64.47378	-65.31301	Commence deploying 9m Gravity Corer
10/01/2014 17:18		-64.47374	-65.31291	On DP in new core position
10/01/2014 16:42		-64.49998	-65.31126	Off DP vessel moving 1.5nm to the north for better core position
10/01/2014 16:37		-64.49996	-65.3098	Vessel to move further to the west
10/01/2014 16:36		-64.49994	-65.30977	Vessel on position
10/01/2014 16:25		-64.4999	-65.30693	Vessel moving to the West for better core position
10/01/2014 16:24		-64.49989	-65.30683	Vessel on station
10/01/2014 15:12		-64.41649	-65.35054	Vessel off DP proceeding to next station
10/01/2014 14:58	15	-64.4165	-65.35055	Corer recovered to frame
10/01/2014 14:48	15	-64.4165	-65.35053	Corer in the bucket
10/01/2014 14:34	15	-64.41651	-65.35052	Corer clear of the seabed
10/01/2014 14:30	15	-64.41649	-65.35051	Corer on the seabed
10/01/2014 14:28	15	-64.4165	-65.3505	Corer 60m from the bottom
10/01/2014 14:16	15	-64.41651	-65.35051	Corer deployed
10/01/2014 14:05	15	-64.41652	-65.3505	Commence deploying 9m Gravity Corer
10/01/2014 13:48		-64.41617	-65.35128	Vsl on DP
09/01/2014 22:38		-64.24306	-65.47796	Vessel off D.P to resume SWATH survey
09/01/2014 22:36		-64.24305	-65.47796	Hydrophone recovered
09/01/2014 21:56		-64.24299	-65.478	FETCH buoy on the seabed
09/01/2014 21:44	14 (FETCH)	-64.24303	-65.47798	FETCH released
09/01/2014 21:42	14 (FETCH)	-64.24303	-65.47798	Commence deploying FETCH
09/01/2014 21:28	13	-64.24305	-65.47799	CTD recovered on deck
09/01/2014 21:25	13	-64.24305	-65.47795	CTD clear of the water
09/01/2014 21:14	13	-64.24307	-65.47797	Wire out 564m
09/01/2014 21:03	13	-64.24307	-65.47797	CTD veering
09/01/2014 21:00	13	-64.24307	-65.47798	CTD deployed
09/01/2014 20:58	13	-64.24307	-65.47798	Commence deploying CTD
09/01/2014 20:38	12	-64.24307	-65.47802	Box corer recovered on deck
09/01/2014 20:36	12	-64.24305	-65.47797	Box corer clear of the water
09/01/2014 20:24	12	-64.24305	-65.47799	Box corer clear of the seabed
09/01/2014 20:20	12	-64.24305	-65.47799	Box corer on the seabed
09/01/2014 20:04	12	-64.24303	-65.47801	Box corer deployed

Time	Event	Lat	Lon	Comment
09/01/2014 20:02	12	-64.24302	-65.478	Commence deploying Box corer
09/01/2014 20:00	11	-64.24306	-65.47798	Corer stowed horizontal in frame
09/01/2014 19:54	11	-64.24306	-65.47799	Corer in the bucket transferred to crane
09/01/2014 19:50	11	-64.24305	-65.47797	Gravity corer at the surface
09/01/2014 19:38	11	-64.24304	-65.47797	Corer clear of the seabed
09/01/2014 19:33	11	-64.24304	-65.47799	Corer on the seabed
09/01/2014 19:18	11	-64.24307	-65.47796	Gravity corer transferred to coring wire
09/01/2014 19:08	11	-64.24256	-65.47743	Commence deploying Gravity corer
09/01/2014 19:05	11	-64.24243	-65.47729	Vessel on D.P
09/01/2014 18:42		-64.27946	-65.4833	Vessel off DP proceeding to next station
09/01/2014 18:25	10	-64.28732	-65.48412	Corer recovered to frame
09/01/2014 18:19	10	-64.28731	-65.48415	Gravity corer recovered to bucket
09/01/2014 18:04	10	-64.28734	-65.48416	Corer clear of the seabed
09/01/2014 18:01	10	-64.28734	-65.48416	Corer on the seabed
09/01/2014 17:45	10	-64.28733	-65.48418	Gravity corer deployed
09/01/2014 17:29	10	-64.28732	-65.48416	Commence gravity corer deployment
09/01/2014 17:24		-64.28734	-65.48415	Vessel on DP on station
09/01/2014 16:54		-64.33697	-65.48924	Vessel off DP
09/01/2014 16:35	9	-64.3372	-65.48951	Gravity corer recovered to the frame
09/01/2014 16:30	9	-64.33719	-65.48951	Gravity corer recovered to bucket
09/01/2014 16:17	9	-64.33716	-65.48951	Corer clear of the seabed
09/01/2014 16:13	9	-64.33717	-65.48952	Corer on the seabed
09/01/2014 15:59	9	-64.3372	-65.48949	Gravity Corer deployed
09/01/2014 15:50	9	-64.3372	-65.48947	Commence deployment of 9m gravity corer
09/01/2014 15:40	8	-64.33723	-65.48951	Box corer recovered
09/01/2014 15:23	8	-64.33719	-65.48952	Box Corer clear of the seabed
09/01/2014 15:19	8	-64.33721	-65.48955	Box corer on the seabed
09/01/2014 15:01	8	-64.33721	-65.48953	Box corer deployed
09/01/2014 14:53	7	-64.33722	-65.48953	Corer recovered to frame
09/01/2014 14:42	7	-64.33719	-65.48949	Corer in the bucket
09/01/2014 14:27	7	-64.33722	-65.48949	Corer clear of the seabed
09/01/2014 14:24	7	-64.33722	-65.4895	Corer in the seabed
09/01/2014 14:22	7	-64.33722	-65.48946	Corer 60m from the bottom
09/01/2014 14:08	7	-64.33724	-65.48951	Corer deployed
09/01/2014 13:59		-64.33701	-65.48911	Commence deploying 6m Gravity Corer
09/01/2014 13:54		-64.33683	-65.48882	VSL on DP
09/01/2014 00:56		-65.03935	-64.77991	Deck all secure
09/01/2014 00:47	6	-65.03936	-64.77991	Corer recovered to frame
09/01/2014 00:35	6	-65.03936	-64.77994	Corer in the bucket
09/01/2014 00:23	6	-65.03947	-64.78023	Corer clear of the seabed
09/01/2014 00:21	6	-65.03946	-64.78022	Corer in the seabed
09/01/2014 00:20	6	-65.03947	-64.78021	Corer 60m from the bottom
09/01/2014 00:12	6	-65.03946	-64.7802	Gravity Corer Deployed
09/01/2014 00:00	6	-65.03944	-64.78025	Commence deploying 3m Gravity Corer
08/01/2014 23:56		-65.04006	-64.77927	Vsl on DP
08/01/2014 21:58		-65.24913	-64.23003	VSI off DP and proceeding to coring station
08/01/2014 21:37		-65.24916	-64.22996	Completion of Boat Operations at Vernadsky
08/01/2014 14:12		-65.24805	-64.22783	Comm. Boat Operations
08/01/2014 14:06		-65.24802	-64.22787	Vsl on DP standing off Corner Is. (Vernadsky)
08/01/2014 10:30		-64.83511	-65.26217	End of swath survey vessel proceeding to Vernadsky
08/01/2014 07:00		-64.30018	-65.40326	Vessel turns to continue SWATH survey
08/01/2014 04:14		-64.74582	-65.29668	Increase speed to 10 knots
08/01/2014 04:10	XBT1	-64.75219	-65.29836	XBT deployed
08/01/2014 04:06		-64.7592	-65.29915	Reduce to 6 knots for XBT
08/01/2014 03:39		-64.83469	-65.29924	Commence SWATH line at 10 knots
06/01/2014 23:18		-66.61985	-70.354	Vsl off DP
06/01/2014 22:58	5	-66.61824	-70.35468	Corer recovered to frame
06/01/2014 22:51	5	-66.61767	-70.35495	Corer in the bucket
06/01/2014 22:34	5	-66.61635	-70.35539	Corer clear of the seabed
06/01/2014 22:31	5	-66.61632	-70.35539	Corer in the seabed
06/01/2014 22:15	5	-66.61501	-70.35559	Corer deployed
06/01/2014 22:04	5	-66.61433	-70.35543	Commence deploying 6m Gravity Corer
06/01/2014 21:38	4	-66.61042	-70.35884	Box corer recovered to deck
06/01/2014 21:22	4	-66.60829	-70.35967	Box corer clear of the seabed
06/01/2014 21:21	4	-66.6083	-70.35968	Box corer on the seabed

Time	Event	Lat	Lon	Comment
06/01/2014 21:05	4	-66.60663	-70.36052	Box corer deployed
06/01/2014 21:04	4	-66.60648	-70.36066	Deploying Box Corer
06/01/2014 20:58	3	-66.60567	-70.36119	Corer in the frame
06/01/2014 20:52	3	-66.60485	-70.36171	Corer recovered to bucket
06/01/2014 20:37	3	-66.60265	-70.36251	Corer clear of the seabed
06/01/2014 20:35	3	-66.60261	-70.36252	Corer on the seabed
06/01/2014 20:20	3	-66.59944	-70.36478	Corer deployed
06/01/2014 20:12	3	-66.59769	-70.36591	Commence deployment of gravity corer
06/01/2014 20:04		-66.59693	-70.36579	Vessel on DP
06/01/2014 19:36		-66.59	-70.32052	Vessel turning to investigate possible core site
06/01/2014 17:30		-66.64758	-70.56037	Vessel proceeding east
06/01/2014 17:22		-66.64629	-70.55877	Off DP
06/01/2014 17:20	2	-66.6459	-70.55846	Box corer recovered
06/01/2014 17:05	2	-66.64434	-70.55674	Box corer clear of the seabed
06/01/2014 17:03	2	-66.64425	-70.55668	Box corer on the seabed
06/01/2014 16:45	2	-66.64247	-70.5538	Box corer deployed
06/01/2014 16:03	1	-66.63769	-70.5512	Corer in the frame
06/01/2014 15:57	1	-66.63711	-70.54997	Corer recovered to bucket
06/01/2014 15:42	1	-66.63615	-70.54533	Corer clear of the seabed
06/01/2014 15:40	1	-66.63615	-70.54532	Corer landed
06/01/2014 15:38	1	-66.63615	-70.5453	Corer 60m from the bottom
06/01/2014 15:23	1	-66.63483	-70.54334	Corer deployed
06/01/2014 15:12	1	-66.6336	-70.54271	Commence deployment of gravity corer
06/01/2014 14:48		-66.63133	-70.54293	Vsl on DP
06/01/2014 13:24		-66.56738	-70.50722	VSL off DP and heading south to pools/leads as conditions not appropriate
06/01/2014 12:48		-66.56776	-70.51011	VSL on DP to assess ice conditions.
06/01/2014 12:25		-66.5703	-70.50571	Comm. turn for clearing ice at coring site
06/01/2014 09:32		-66.60633	-70.63034	VSL off DP to head a East through leads in the ice.
06/01/2014 09:12		-66.60629	-70.6382	VSL on DP to assess ice movement and wait for further instruction.
05/01/2014 14:56		-67.80848	-68.61945	Start swath

Appendix 2. Coring station table

(see section 5.2). GC: gravity corer, BC: box corer.

Gear	Station	Date	Start (UTC)	At Seafloor (UTC)	End (UTC)	Location	Latitude (°S)	Longitude (°W)	Water depth (m)	Recovery (m)*
GC (3m)	682	06/01/2014	15:23	15:40	15:58	Marguerite Trough outer shelf	66° 38.17'	70° 32.71'	568	1.27
BC	683	06/01/2014	17:45	17:02	17:20	Marguerite Trough outer shelf	66° 38.66'	70° 33.39'	573	0.195
GC (3m)	684	06/01/2014	20:19	20:34	20:52	Marguerite Trough outer shelf	66° 36.16'	70° 21.75'	593	2.365
BC	685	06/01/2014	21:05	21:20	21:41	Marguerite Trough outer shelf	66° 36.50'	70° 21.58'	593	ca. 0.20
GC (6m)	686	06/01/2014	22:16	22:31	22:47	Marguerite Trough outer shelf	66° 36.02'	70° 22.27'	590	2.755
GC (3m)	687	09/01/2014	00:10	00:20	00:32	Anvers Trough inner shelf	65° 02.36'	64° 46.81'	344	0.205
GC (6m)	688	09/01/2014	14:09	14:23	14:43	Anvers Trough middle shelf	64° 20.23'	65° 29.37'	583	5.23
BC	689	09/01/2014	15:02	15:18	15:39	Anvers Trough middle shelf	64° 20.23'	65° 29.37'	584	ca. 0.25
GC (9m)	690	09/01/2014	15:59	16:13	16:31	Anvers Trough middle shelf	64° 20.23'	65° 29.37'	584	6.08
GC (6m)	691	09/01/2014	17:45	18:00	18:17	Anvers Trough middle shelf	64° 17.24'	65° 29.49'	604	4.095
GC (6m)	692	09/01/2014	19:18	19:32	19:51	Anvers Trough middle shelf	64° 14.58'	65° 28.68'	578	4.73
BC	693	09/01/2014	20:04	20:18	20:36	Anvers Trough middle shelf	64° 14.58'	65° 28.68'	577	0.315
GC (9m)	694	10/01/2014	14:14	14:29	14:46	Anvers Trough middle shelf	64° 24.99'	65° 21.30'	599	5.33
GC (9m)	695	10/01/2014	17:27	17:41	17:59	Anvers Trough middle shelf	64° 28.43'	65° 18.78'	629	6.74
BC	696	10/01/2014	18:13	18:28	18:46	Anvers Trough middle shelf	64° 28.43'	65° 18.78'	628	0.295
GC (9m)	697	10/01/2014	20:48	21:01	21:19	Anvers Trough middle shelf	64° 36.30'	65° 20.60'	583	7.345
GC (9m)	698	10/01/2014	22:55	23:07	23:23	Anvers Trough middle shelf	64° 42.00'	65° 14.00'	607	6.34
BC	699	10/01/2014- 11/01/2014	23:45	00:06	00:16	Anvers Trough middle shelf	64° 42.00'	65° 14.00'	605	0.325
GC (6m)	700	11/01/2014	13:54	14:06	14:25	Anvers Trough middle shelf	64° 13.17'	65° 01.71'	534	1.825
BC	701	11/01/2014	14:40	14:53	15:01	Anvers Trough middle shelf	64° 13.17'	65° 01.71'	534	ca. 0.32
GC (9m)	702	11/01/2014	16:53	17:05	17:23	Anvers Trough middle shelf	64° 15.27'	65° 22.31'	560	4.93
GC (9m)	703	11/01/2014	19:02	19:15	19:31	Anvers Trough middle shelf	64° 16.60'	65° 36.21'	564	3.86
GC (9m)	704	12/01/2014	12:18	12:28	12:43	Anvers Trough outer shelf	63° 53.21'	65° 30.68'	475	4.17
BC	705	12/01/2014	13:00	13:13	13:29	Anvers Trough outer shelf	63° 53.21'	65° 30.67'	476	ca. 0.38

Gear	Station	Date	Start (UTC)	At Seafloor (UTC)	End (UTC)	Location	Latitude (°S)	Longitude (°W)	Water depth (m)	Recovery (m)
GC (3m)	706	12/01/2014	14:26	14:37	14:52	Anvers Trough outer shelf	63° 54.65'	65° 30.83'	453	2.38
GC (6m)	707	12/01/2014	15:34	15:45	15:58	Anvers Trough outer shelf	63° 54.64'	65° 30.83'	453	0.83
GC (6m)	708	12/01/2014	20:32	20:43	20:57	Anvers Trough outer shelf	63° 52.61'	65° 41.37'	472	4.305
GC (9m)	709	14/01/2014	17:38	17:50	18:06	Anvers Trough middle shelf	64° 37.94'	65° 19.82'	556	3.59
BC	710	14/01/2014	18:24	18:37	18:54	Anvers Trough middle shelf	64° 37.94'	65° 19.81'	555	ca. 0.24
GC (9m)	711	14/01/2014	20:27	20:41	20:57	Anvers Trough middle shelf	64° 31.64'	65° 22.88'	614	5.88
GC (9m)	712	14/01/2014	23:24	23:36	23:50	Anvers Trough middle shelf	64° 28.10'	64° 52.19'	587	3.965
BC	713	15/01/2014	00:16	00:31	00:47	Anvers Trough middle shelf	64° 28.10'	64° 52.20'	587	0.365
GC (9m)	714	15/01/2014	17:17	17:28	17:45	Anvers Trough middle shelf	64° 17.67'	64° 54.16'	507	2.34
BC	715	15/01/2014	18:11	18:25	18:39	Anvers Trough middle shelf	64° 17.67'	64° 54.16'	507	ca. 0.32
GC (9m)	716	15/01/2014- 16/01/2014	23:44	23:56	00:10	Anvers Trough middle shelf	64° 16.07'	65° 08.69'	537	4.05
GC (9m)	717	16/01/2014	11:54	12:06	12:22	Anvers Trough middle shelf, eastern tributary	64° 14.61'	64° 34.45'	555	6.085
BC	718	16/01/2014	12:45	12:59	13:15	Anvers Trough middle shelf, eastern tributary	64° 14.61'	64° 34.46'	554	ca. 0.37
GC (9m)	719	16/01/2014	15:45	15:57	16:15	Anvers Trough middle shelf, eastern tributary	64° 13.22'	64° 15.19'	582	3.91
BC	720	16/01/2014	16:32	16:48	17:04	Anvers Trough middle shelf, eastern tributary	64° 13.22'	64° 15.19'	582	ca. 0.37

*: Recovery of BC was measured within the box and so the retrieved subcores are shorter than the total recovery due to compaction.

Appendix 3. CTD and XBT station table

Station ID	Day	Time (GMT)	Latitude	Longitude	Coring station	SVP filename
XBT01	008	04:11	64° 45.66' S	65° 17.88' W		T7_0001_thinned.asvp
CTD01	009	20:57	64° 14.58' S	65° 28.68' W	GC692/BC693	JR284_694_thinned.asvp*
CTD02	012	21:30	63° 52.61' S	65° 41.38' W	GC708	JR284_002_thinned.asvp
XBT02	017	16:14	60° 59.70' S	65° 05.77' W		T7_0002_thinned.asvp

*Subsequently renamed to JR284_001_thinned.asvp

Appendix 4. Typical sonar system parameter settings

A4.1 EM122 Acquisition Parameters

MBES screen, “EM122 Runtime Menu”

Ping Mode: AUTO (but also sometimes set to the MEDIUM fixed depth mode)

Sector Coverage

Max Port Angle:	40 - 68°
Max Starboard Angle:	40 - 68°
Angular Coverage:	Auto
Beam Spacing:	Equidistant

Pitch stabilization: On

Yaw stabilization: On in ‘Re Filtered Heading’ mode

Min Depth: used to constrain depth when in ice or using TOPAS chirp Tx on fixed cycle

Max Depth: used to constrain depth when in ice or using TOPAS chirp Tx on fixed cycle

Sound Speed at Transducer:

Sound Speed:	1500 m/s
From:	Profile
Sensor Offset:	0.0 m/s
Filter:	60 s

Filtering

Spike Filter Strength:	Medium
Range Gate:	Normal
Phase Ramp:	Normal
Penetration Filter Strength:	Off
Aeration:	Off
Sector Tracking:	On
Slope:	On
Interference:	Off

Absorption Coefficient

Source:	Salinity
Salinity (parts per thousand):	35

Normal incidence sector

Angle from nadir (deg.):	6
--------------------------	---

Mammal protection

TX power level (dB):	Max
Soft startup ramp time (min.):	0

A4.2 TOPAS Acquisition Parameters

Acquisition/ Transmitter Menu

Pulseform:	Chirp (LFM)
Chirp start frequency (Hz):	1300
Chirp stop frequency (Hz):	5000
Length (ms):	15
Transmit mode:	Normal
Trigger mode:	External
Power level (dB):	-2
Transducer sound speed:	1500
HRP stabilisation:	On

Acquisition/ Receiver 1 Menu

Sample rate:	20000 Hz
Trace length (ms):	400
Gain:	14 dB
HP- Filter:	1.00 kHz
Delay control:	Manual (but Tracking also used when unattended)

Processing/ Filters Menu

Filter type:	Matched	
Corner frequencies:	Manual	
Filter:	ON	
Replica shaping:	ON	
	Low stop: 1900	Low pass: 3900
	High pass: 3100	High stop: 5100

Processing/ Data Plotter 1 Menu: Enabled

Processing/ Data Logger Menu: Enabled
File close/ append: 25
Maximum file size: 100 MB

Processing/ Bottom Tracker Menu: Enabled
Show master depth: Enabled
Autosearch: Enabled

Processing/ Time Variable Gain: Enabled
TVG Control: TRACKING
Offset: 0
Section A – B Length (ms): 22.6 Slope (dB/ms): 0.55
Section B – C Length (ms): 59.7 Slope (dB/ms): 0.08
Section C – D Length (ms): 64.2 Slope (dB/ms): 0.06

Processing/ Attribute Processing: Enabled



A big nose (Photo: Matthieu Cartigny).