

P.O.L.

RRS CHARLES DARWIN

CRUISE 105

LEG A:

LISBON

to

VIGO

and

LEG B:

VIGO

to

SOUTHAMPTON

29 MAY 1997

to

22 JUNE 1997

Dr. J.M. HUTHNANCE

OCEAN MARGIN

EXCHANGE

(OMEX II-II)

CRUISE REPORT NO. 26

1997

**PROUDMAN
OCEANOGRAPHIC
LABORATORY**

PROUDMAN OCEANOGRAPHIC LABORATORY

**Bidston Observatory
Birkenhead, Merseyside, L43 7RA, UK
Tel: 0151 653 8633
Telex: 628591 Ocean B G
Fax: 0151 653 6269**

Director: Dr. B.S. McCartney

Natural Environment Research Council

RRS CHARLES DARWIN CRUISE 105

OCEAN MARGIN EXCHANGE (OMEX II-II)

Leg A: Lisbon to Vigo

and

Leg B: Vigo to Southampton

Principal Scientist: Dr. J.M. Huthnance

DOCUMENT DATA SHEET

AUTHOR HUTHNANCE, J.M.	PUBLICATION DATE 1997
TITLE CRUISE REPORT RRS <i>CHARLES DARWIN</i> 105, 29 May to 22 June 1997. Ocean Margin Exchange (OMEXII-II)	
REFERENCE Proudman Oceanographic Laboratory, Cruise Report, No. 26	
ABSTRACT <p>RRS <i>Charles Darwin</i> cruise 105 was the first of several planned for approximately 6-month intervals as part of the EU MAST Ocean Margin Exchange (OMEX II-II) project. This phase of OMEX focuses on the NW Iberian continental shelf and slope, aiming to construct and understand the cycles of carbon and associated elements; this involves the transfer of organic carbon, nutrients and other trace elements which may be rapidly deposited to the sediments and buried, and the study of physical processes affecting horizontal and vertical transport.</p> <p>Leg A carried out multi-beam echo-sounding, associated side-scan and 3.5kHz sounding to map the sea-bed bathymetry and structure between 41°45'N and 43°5'N, from the upper slope (typically 200-500m depth) to 10°6'W (typically 2500-3000m depth). Box and Kasten cores were taken at various depths along 41°48'N and 42°20'N to analyse the bed sediment structure and deposition. A trial Inverted Echo Sounder deployment was carried out.</p> <p>On leg B, a bottom-mounted acoustic Doppler current profiler was deployed in 156 m depth and a mooring of four current meters in 686 m, both near 42°40'N where two more moorings with sediment traps were planned for a cruise in July 1997. Underway ADCP, temperature, salinity, fluorescence, transmittance and irradiance were recorded. Night and day plankton net hauls were taken, and an LHPR was towed on six occasions, night and day. The main activity was a grid of CTD stations, typically 10 km apart, on cross-slope sections at 43°N, 42°50'N, 42°40'N, 42°30'N, 42°20'N, 42°09'N, 42°N, 41°48'N, 41°25'N, recording profiles of temperature, salinity, fluorescence, dissolved oxygen, radiance, transmittance and optical backscatter. Water samples were taken at many of these stations to analyse for nutrients, primary production, pigments, DOC, bacteria, microzooplankton, natural radio-nuclides, SPM and POC. Some were exchanged with <i>Belgica</i> for intercalibration between analyses on the two ships and in Vigo. A CTD cast was carried out close to one by <i>Belgica</i>, also for intercalibration.</p> <p>ACKNOWLEDGEMENT. The scientific party extends warm thanks to the Master, R. Plumley, officers and crew of RRS Charles Darwin ^{<i>Charles Darwin</i>} for their help and co-operation during the cruise, and to RVS for its support, all willingly given and making the scientific work possible.</p>	
ISSUING ORGANISATION Proudman Oceanographic Laboratory Bidston Observatory Birkenhead Merseyside L43 7RA UK Director: Dr B S McCartney	TELEPHONE: (0151) 653 8633 FAX: (0151) 653 6269 TELEX: 628591 OCEAN BG
KEYWORDS IBERIAN MARGIN ATLNEIBE OMEX EXCHANGE HYDROGRAPHY MOORINGS SAMPLING CORES CONTINENTAL SHELVES CONTINENTAL SLOPE	CONTRACT PROJECT MSH-21-5 PRICE £11.00

CONTENTS

	Page No.
1. OBJECTIVES	7
2. SUMMARY	8
3. PERSONNEL ON BOARD	9
4. NARRATIVE	10
5. TECHNICAL REPORTS	15
5.1 Swath bathymetry	15
5.2 3.5 kHz sounder and EA500 sounder	17
5.3 Box coring	17
5.4 Kasten coring	18
5.5 Inverted Echo Sounder	19
5.6 ADCP mooring	20
5.7 Current meter line mooring	20
5.8 Ship-borne ADCP	20
5.9 Underway recording and sampling	20
5.10 CTD	21
5.11 Satellite imagery	21
5.12 Nutrients and intercalibration samples	22
5.13 Phytoplankton and "new" production, ammonia regeneration and nitrification	22
5.14 Phytoplankton chemotaxonomy using chlorophyll and and carotenoid pigments	24
5.15 Dissolved Organic Carbon Production	25
5.16 Bacterial production biomass	26
5.17 Microzooplankton	26
5.18 Natural radionuclides	26
5.19 Suspended particulate matter	27
5.20 Longhurst-Hardy Plankton Recorder and zooplankton net	29
5.21 Phytoplankton net	30
5.22 Differential GPS	30
5.23 Ship systems	30
5.24 Computing	31
6. CONCLUSIONS	32

TABLES

1	Cores	34
2	Moorings	34
3	Net casts	35
4	CTD casts	36
5	CTD temperature calibration against reversing thermometers	38
6	CTD salinity calibration against bottle samples (with figure)	39
7	Thermosalinograph salinity against water samples (with figure)	41
8	Sampling for pigments, biogenic calcite and silicate, microzooplankton	43

FIGURES

1	Overall track plot	44
2	Detailed track plot - Leg A	45
3	Detailed track plot and mooring locations - Leg B	46
4	Coring locations and IES position	47
5	CTD and water sampling stations	48

1. OBJECTIVES

Overall OMEX objectives are to construct and understand the cycle of carbon and associated elements along the Iberian coast, dominated by variable upwelling processes. This involves the transfer of organic carbon, nutrients and other trace elements which may be rapidly deposited to the sediments and buried, and the study of physical processes affecting horizontal and vertical transport.

Specific Objectives for *RRS Charles Darwin* Cruise 105 were:

Leg A:

A.1 Swath bathymetry and 3.5 kHz sounding continuously, primarily on along-slope tracks, for coverage

- 41.8° to 43°N in depths > 1000m out to 10°W and beyond;
- upper slope (200-500m) sounding and bathymetry to cover intended mooring and coring locations: especially near 42°40'N (moorings and coring) and 42°20'N (coring).

A.2 Kasten and box coring, at various depths greater than about 500m on cross-slope sections near 41.8°N and 42°20'N, the latter out to the 2000m contour on Galicia Bank, with one or two cores also below Canyon de Porto near 41.4°N.

A.3 Trial deployment and recovery of a POL inverted echo sounder in about 1200m.

Leg B:

B.1 Deploy an ADCP mooring at about 180m water depth and a current meter "string" at about 700m water depth, both near 42°40'N according to the findings of Leg A swath bathymetry (avoiding locations with a steep slope or spur for later sediment trap moorings in 1500 and 2500m at the same latitude).

B.2 CTD and water sample stations: cross-slope sections at 41°25'N and in the nearby canyon, near 41.8°N and at 42°, 42°09'N, 42°20'N, ... (10' intervals) to 43°N, from 100m water depth inshore to 10°W offshore. More concentrated CTDs near any features revealed by satellite AVHRR images.

In particular, standard "reference" stations at 42°09'N, 42°40'N and 43°N at water depths 100, 200, 1000, 2000 m, also at 42°09'N in the ria mouth, at 50 m water depth and "oceanic" about 100 km offshore, worked to full water depth.

Sampling density O(5 km) along these sections, but not all to full depth.

B.3 Pre-dawn and mid-day casts for nutrients, primary production (incubations), pigments, DOC, bacteria and microzooplankton incorporated into B.2, typically from samples at about 12 depths at 10m intervals down to about 120m.

B.4 Repeat CTDs incorporated into B.2, for samples as in B.3, for pigments, to about 200m for naturally occurring radionuclides needing 10 l bottle samples, for 20-40 l samples for SPM and over a tidal period to estimate any thermocline displacements and diurnal heating.

B.5 Longhurst-Hardy Plankton Recorder tows, about two hours each at mid-day (on four to six days) and midnight (on four to six days) with a shallow CTD at either end. Also vertical net

hauls to about 200m (two per day) and water sampling for chlorophyll analysis.

B.6 Continuous ADCP and non-toxic supply: monitoring, bi-hourly sampling.

B.7 Rendezvous and intercalibration with *Belgica*, ideally at dawn near 43°N, and samples transfer.

B.8 Nutrient intercalibration samples throughout depth from shelf (100m) slope (200m) and deep (2000m) waters along 42°09'N, at longitudes 8°57.5'W, 9°19'W and 9°44'W, to be analysed and also retained (filtered and quick-frozen; chilled) for later analysis by IIM, ULB, VUB.

2. SUMMARY

Leg A carried out multi-beam echo-sounding, associated side-scan and 3.5kHz sounding between 41°45'N and 43°5'N, from the upper slope (typically 200-500m depth from 42°20'N to 42°40'N) to 10°6'W (typically 2500-3000m depth). Thus the intended coverage was achieved except for the uppermost slope and an extension west along 42°20'N towards Galicia Bank. Box cores were taken at various depths along 41°48'N and 42°20'N; Kasten cores at depths ~ 1100, 1600, 2700m along the former line and 1800m on the latter; no core was obtained on Galicia Bank. No suitable coring site near Canyon de Porto was identified. The trial Inverted Echo Sounder deployment and recovery were carried out successfully. Three days of adverse weather reduced the number of successful cores taken but had less effect on the bottom surveying.

On leg B, a bottom-mounted acoustic Doppler current profiler was deployed in 156 m depth and a mooring of four current meters in 686 m. Both were close to their planned depths and near 42°40'N where two more moorings with sediment traps were planned for a cruise in July 1997. The main activity was a grid of CTD stations, typically 10 km apart, on cross-slope sections at 43°N, 42°50'N, 42°40'N, 42°30'N, 42°20'N, 42°09'N, 42°N, 41°48'N and 41°25'N, recording profiles of temperature, salinity, fluorescence, dissolved oxygen, up- and down-welling radiance, transmittance and optical backscatter. Water samples were taken at many of these stations to analyse for nutrients, biogenic silicate and calcite, primary production, pigments, DOC, bacteria, microzooplankton, natural radio-nuclides, SPM and POC. These stations include all the standard "reference" stations, the SEFOS lines - although a few stations were omitted - and pre-dawn casts for primary production incubation samples on nine days. Night and day plankton net hauls were taken, and an LHPR was towed on six occasions, night and day. Underway ADCP, temperature, salinity, fluorescence, transmittance and irradiance were recorded continuously, and for some specific periods samples were analysed for nutrients. CTD casts were repeated a week later at two stations, and after a short interval to 100-200m at several more; these may give some estimate of (tidal) displacements of the thermocline; the aggregate of CTD casts shows diurnal heating effects although no 12hr CTD series were performed. Samples from the three designated positions on 42°09'N were exchanged with *Belgica* for intercalibration between analyses by scientists on the two ships, in Vigo and at PML. A CTD cast with water sampling was carried out at 42°30'N close to one by *Belgica*, also for intercalibration. Very little time was lost to adverse conditions.

3. PERSONNEL ON BOARD

(noting if Leg A or Leg B only)

Scientists

J.	Huthnance (PS)	POL
J.	Ashley	POL (A)
P.	Weatherall	BODC (A)
D.	Neave	BODC (B)
I.	Hall	UCamb
C.	Fogwill	UCamb
M.	White	UCG (B)
T.	Furey	UCG (B)
A.	Pomroy	PML (B)
A.	Rees	PML (B)
D.	Cummings	PML (B)
R.	Barciela	UVigo (B)
A.	Hirst	SOC (B)
P.	L'Henoret	CFR (A)
S.	Schmidt	CFR (B)
D.	Booth	RVS (A)
D.	Teare	RVS
P.	Howarth	RVS
J.	Tilling	RVS (A)
I.	Udal	RVS (A)
R.	Pearce	RVS
H.	Anderson	RVS (A)
P.	Mason	RVS
T.	Claridge	RVS
D.	Rees	RVS

Officers and crew

R.	Plumley	Master
R.	Chamberlain	C/O
R.	Warner	2nd Officer
P.	Reynolds	3rd Officer
I.	McGill	Chief Eng.
A.	Greenhorn	2nd Engineer
B.	Walker	3rd Engineer
C.	Phillips	3rd Engineer
J.	Baker	Radio Officer
M.	Drayton	CPO (Deck)
M.	Harrison	Seaman PO
J.	Perkins	Seaman
R.	Johnson	Seaman
J.	Dale	Seaman
S.	Day	Seaman
A.	Healy	Motorman
R.	Bell	SCM
E.	Bolton	Chef
J.	Swenson	2nd Steward
J.	Godman	Steward
S.	Shields	Steward

4. NARRATIVE

(All times GMT). See Figures 1 to 3 for general area map and cruise tracks.

29/05/97 (Julian Day 149) RRS *Charles Darwin* left the Lisbon quayside at 0700 and proceeded down the estuary for bunkering (0755-1405) before heading out of the Tagus estuary and northwards to the first coring site in good conditions. Thermosalinograph recording commenced at 1850.

30/05/97 (JD 150) The swath bathymetry was switched on and the 3.5kHz sounder deployed at 0600 on approach to Porto canyon. A short passage over the canyon did not find a seamount indicated on the Admiralty chart at 41°24.5'N, 9°17'W, but did show slopes too steep for coring. RRS *Charles Darwin* hove to at 0850 for a sound velocity profile to be taken (0905-1100). Course was then set for 41.8°N and 1000m depth where, after a short reconnaissance, two box cores and a Kasten core were attempted. However, the first box core (1400-1455) penetrated too deep into the soft sandy mud, losing the surface layer from the top of the box, the spade did not operate to close the box on the following attempt (1600-1700) and the Kasten corer also failed to close (1735-1830). At this late hour coring operations ceased and the first of the lines for systematic swath bathymetry was begun at 41.8°N, 9°25.6'W (1905). (It had been intended to deploy the Inverted Echo Sounder - IES - in 1200m at 41.8°N, but indications from the multi-beam sounder before and during the coring suggested that the slope would be too steep; the soft mud was also a deterrent).

31/05/97 (JD 151) Swath bathymetry and 3.5kHz sounding continued through the night under continuing good conditions until 0730 (halfway south on the second line) when a short reconnaissance revealed a seamount near 42°24'N, 9°35'W and a more suitable region for the IES deployment on the gentle continental slope to the east. During the deployment (0905-1000 including acoustically following it to the bottom) the Multi-beam sounder was switched off. Systematic mapping began again, resuming the second swath line at 1040. This was completed at 1440. A box core was then taken at the previous day's site (1540-1635); again the corer penetrated too deep into the mud, but some samples were retained. Successful box and Kasten cores were then taken (1725-1825; 1905-2010) from near the top of a ridge ~ 41°47.5'N in ~ 1100m depth. Course was then made to begin the third swath bathymetry line at 41.8°N, 9°33'W (2120).

1/6/97 (JD 152) Swath bathymetry and 3.5kHz sounding continued through the night and morning, under continuing good conditions, until the third and fourth lines were completed (1410). A box core was then attempted unsuccessfully in about 1300m near 41.8°N (1440-1625 including some time regaining the desired depth with the corer in the water). In view of the time it was decided to move on to the next depth ~ 1600 m where a box core was taken successfully (1705-1830) followed by a successful Kasten core (1915-2035). Course was then made to begin the fifth swath bathymetry line at 41.8°N, 9°44.5'W (2215).

2/6/97 (JD 153) Swath bathymetry and 3.5kHz sounding continued through the night, with more swell than hitherto but still good conditions, and the sixth line was begun at 43°N, 9°52'W at 0717 and completed at 41.8°N, 9°52'W at 1505, when a turn was made for a coring site just to the east in ~ 2500 m. A successful box core was taken (1535-1735) followed by a Kasten

core attempt at the same position (1815-2005). In view of the time, and with the expectation of being able to return for another Kasten core attempt, course was then made to begin the seventh swath bathymetry line nearby at 41.8°N, 9°48.3'W (2120).

3/6/97 (JD 154) Swath bathymetry and 3.5kHz sounding continued through the night in continuing good conditions; the eighth line was begun at 43°N, 9°55.8'W at 0615 and completed at 41.8°N, 9°55.8'W at 1400, when track was made for the previous day's coring site. A Kasten core was attempted twice (1440-1640; 1655-1850), making three times in all at this site. Hence it was decided to move on to the west. After some reconnaissance around a seamount, a successful Kasten core was taken in 2723m (2025-2235) followed by a box core (2300-0105).

4/6/97 (JD 155) RRS *Charles Darwin* proceeded to the ninth swath bathymetry line, beginning at 41.8°N, 10° 3.3'W (0213) and continuing to the beginning of the tenth line at 43°N, 9°59.5'W (1031). Conditions remained good, and on completing this line at 41.8°N, 9°59.5'W (1825) track was made for a deep coring site near 41.8°N, 10°07'W where a box core was taken in 2900 m (1930-2145) followed by an attempted Kasten core (2215-0025).

5/6/97 (JD 156) Course was then made along 41°45'N eastwards with a gentle turn to follow 9°40.5'W northwards so as to begin filling in the bathymetric survey area covered hitherto. Subsequent southward tracks filled in small gaps between the coverage of lines two and four, and between lines one and two, and regained 41.8°N. However, conditions had deteriorated and it was decided not to attempt any coring during this last planned visit to 41.8° (some cores around 2000m depth had been hoped for). Swath bathymetry continued westwards and then northwards along 9°36.7'W, soon completing the last remaining gap in coverage south of 42½°N. Course was then made to fill small gaps north of 42½°N, going northwards between lines one and two.

6/6/97 (JD 157) The gap-filling continued to 43°2'N, then course was made to complete the remainder, but at this stage (0400) deteriorating conditions prevented the course being held. For the next day and a half, weather dictated the course although swath bathymetry continued.

7/6/97 (JD 158) Conditions slightly eased during the morning so that at 1320 course was made northwards and the gap-filling was completed. Course was then made to begin adjacent slope-parallel lines from 42°43'N to 42°17'N to extend the cover up the continental slope.

8/6/97 (JD 159) Three of these slope-parallel lines were completed by 0900 when RRS *Charles Darwin* turned to begin a fourth northwards. As conditions had improved overnight, the line was broken at 42°24'N (0855) to get close to and recover the Inverted Echo Sounder deployed on day 151 (0945-1045). Then course was made to the first of a sequence of coring stations near 42°20'N in 434m (1200-1240), 1240m (1340-1450), 1831m (1610-1740) - all box cores. The latter proved to be in soft mud, so it was decided that, with time remaining for just one more core, this should be a Kasten core at the same position (1835-1955). Then RRS *Charles Darwin* rejoined the swath bathymetry line broken in the morning (2130). This was completed at 2330 and the fifth line begun.

9/6/97 (JD160) The fifth line was completed at 0250 and course made for Vigo where RRS *Charles Darwin* came alongside at 0700.

10/6/97 (JD161) RRS *Charles Darwin* left Vigo at 0600 to begin leg B in moderate conditions. Underway thermosalinograph and ship-borne ADCP measurements were begun (0842). Course was made to an approximate location for the ADCP deployment, and after a short reconnaissance deployment was made in 156 m at 42°40.94'N, 9°28.58'W (1240-1250). RRS *Charles Darwin* then steamed westward along the P line for a CTD station in ~ 750 m (1400-1530) and a wire test of the P700 mooring acoustics (1550-1620). This mooring of four current meters was then deployed buoy first (1720-1855). Course was then made for the northern "N" line of CTD and water sampling stations at 43°N. Attempts were made to carry out CTD casts at the shallowest station "N30" (cast 2, 2220; cast 3, 2300) but the water sample bottles were not firing. "Casts" 4 and 5 were deck tests; then on cast 6 bottles were fired on the down cast.

11/6/97 (JD162) On cast 7 at "N100" bottles again failed to fire (0120). Two net hauls were taken here (0140-0150, 0155-0200). RRS *Charles Darwin* remained on station while the CTD fault was investigated. With the prospect of CTD reassembly to a profiling system which would need to be tested, and limited water sampling (0900), course was made to deeper water during reassembly to enable a first LHPR deployment. Here the CTD was tested successfully in the water, UCG and SOC net hauls were taken (1200-1205, 1215-1230), the CTD was again tested successfully, and the LHPR was deployed. With increasing confidence in the CTD system, course was made eastwards during the LHPR tow (1310-1520). Thence a full CTD cast was made at "N100" (1630-1655) to resume the CTD and water sampling sequence westwards along line "N". This was followed by casts at "N220" (1800-1825), "N1600" (1920-2030) and "N2300" (2135-2335) in continuing good conditions for this work.

12/6/97 (JD163) At "N2000" zooplankton (SOC) and UCG net hauls were carried out (0025-0045) before a deep CTD cast (0050-0230) followed by a shallow pre-dawn cast for samples for incubation etc. (0310). The "N" line was continued with "N3100" (0445-0650) and finished with "N3300" (0820-1050) where SOC zooplankton and UCG phytoplankton net hauls were also taken (1120-1145) and a shallow repeat CTD cast for irradiance profiles (1150-1205). The LHPR was then towed southwards (1240-1420) and course made for 10°W on the "O" line at 42°50'N. This was worked eastwards with stations at "O2650" (1600-1800), "O2000" (1920-2050) and "O1000" (2150-2300) in continuing good conditions.

13/6/97 (JD164) On arrival at the next station, the depth was found to be shallower than charted and the zooplankton net haul was aborted. A UCG plankton net haul was carried out (0015) and then a CTD cast at this (renamed) station "O175" (0040-0100). At "O140" a zooplankton net haul (0150-0200) and two CTD casts were carried out owing to misfires (0240-0400) before proceeding to the "P" line at 42°40'N. "P50" was omitted owing to coastal fog and traffic; the line was worked offshore with CTD casts at "P100" (0525-0600), "P130" (0720-0745), "P200" (0840-0915), "P1000" (1020-1145) with an additional shallow cast for radiances (1220-1235), "P2000" (1430-1615), "P2250" (1705-1900) and "P2800" (2020-2230). Course was then made for the "Q" line at 42°30'N. Conditions had remained good all day.

14/6/97 (JD165) On arrival at 10°W, "Q2500", phytoplankton and zooplankton net hauls were carried out (0100-0120) followed by the pre-dawn CTD cast (0125-0315). A CTD cast was also performed at "Q2200" (0420-0555), the next station onshore along the "Q" line. Scientific work was then suspended in order to inspect the deep-tow cable by streaming in deep water, going southwards near the western ends of the OMEX sections. This work was completed earlier than

anticipated, and the opportunity was taken for zooplankton and phytoplankton net hauls (1210-1225) and an LHPR tow (1240-1455). RRS *Charles Darwin* then proceeded to the offshore end of the southernmost section "V" at 41°25'N. A CTD cast was carried out at the deepest station "V3100" (1810-2015) followed by a phytoplankton net haul (2020-2030) and "V2800" (2135-2300). Conditions were good with light northerly winds all day.

15/6/97 (JD166) From "V2800" RRS *Charles Darwin* continued eastwards and the first night-time LHPR tow was undertaken (2350-0115). The pre-dawn CTD cast and a zoo-plankton net haul were then carried out at "V2600" (0145-0315; 0350-0405). The "V" line was continued eastwards with CTD casts at "V2400" (0500-0615), "V2200" (0655-0840), "V1150" (0930-1045), a phytoplankton net haul and CTD cast at "V160" (1130-1135; 1140-1215), CTD casts at "V110" (1300-1320), "V75" (1410-1430), and a phytoplankton net haul and CTD cast at "V55" (1510-1515; 1520-1535) to complete the line. A distinction had been seen between clear blue, saline, oceanic water offshore and less clear green, fresher surface water inshore. Hence a zig-zag course was made to cross and re-cross this water boundary. It was crossed just beyond 41°36'N 9°10'W; then course was made to the inshore end of the "U" line at 41°48'N. This line was worked offshore with CTD casts at "U100" (1835-1855), "U120" (1945-2015), "U1000" (2140-2235) and "U2000" (2340-0100) in good conditions.

16/6/97 (JD167) Station "U150" had been omitted in the previous evening's sequence in order to perform the pre-dawn cast in shallow waters there; this was done (0225-0300) followed by plankton net hauls (0300-0320). The "U" line was then completed with CTD casts at "U2500" (0535-0720) and "U2800" (0900-1100) and a phytoplankton net haul at the latter. Course was made to 42°N and the "T" line was worked onshore with CTD stations at "T2500" (shallow with light sensors, 1300-1335; deep, 1400-1550), "T2100" (1730-1910 after a little delay sorting loose turns on the drum), "T2000" (2010-2135) and "T1600" (2230-2340). Here a phytoplankton net haul was taken (2340-2350) before continuing eastwards.

17/6/97 (JD168) The LHPR was deployed (0040-0135) followed by the pre-dawn CTD cast at "T200" (0210-0230) where zooplankton and phytoplankton net hauls were taken (0235-0250). The section was then completed with CTD stations at "T1000" (0345-0440; by-passed earlier to obtain the LHPR tow and pre-dawn cast in shallower water), "T150" (0540-0605; bottle misfires at 10m coming up) and "T100" (0710-0730; more misfires). Course was made for the "S" section at 42°9'N while the CTD was attended to. This section was then worked offshore with only occasional misfires: "S90" (0845-0905; extra samples were taken for inter-calibration with OMEX partners not on board), "S130" (0950-1005) and "S150" (1050-1115) with a phytoplankton net haul also (1120). Then the LHPR was towed (1205-1300) on the way to "S200" where phytoplankton and zooplankton net hauls (1330-1345) were followed by a CTD cast (1355-1425; again extra samples for intercalibration). The "S" line was continued with casts at "S600" (1515-1600), "S1000" (1635-1730) and "S2000" (1855-2025), slightly slowed by choppy seas in the winds increasing to force 6. During the afternoon it was learned that sadly the father of one of the crew had died. In order to enable the crew member to transfer by boat to Vigo and fly home, the "S" line was curtailed at this point and course made for the "R" line on 42°20'N to secure a pre-dawn cast at the 1000m station. A CTD cast (2243-0000) and phytoplankton net haul (0015) were first obtained at "R1500".

18/6/97 (JD169) At "R1000", following a zooplankton net haul (0110) the intended pre-dawn CTD cast for primary production measurements was carried out (0135-0235). RRS *Charles*

Darwin then made course for the ria de Vigo where the boat transfer was carried out (a spare CTD rosette mounting and control unit was also taken on board; 0715-0725). Course was then made back to the "R" line and CTD casts were made at "R100" (0850-0910) and "R150" (1020-1035). At "R200" a phytoplankton net haul (1120) was followed by a CTD cast (1130-1200) and a test of an acoustic release on its side, like that on the ADCP deployed on JD161 (1210-1230). Course was then made to "R600" where a phytoplankton net haul (1340) was followed by a CTD cast (1353-1420); misfires on this cast caused a repeat (1500-1530) which was successful. A CTD cast at "R2000" followed (1730-1900). In order to have a pre-dawn cast for primary production over the upper slope, RRS *Charles Darwin* turned south-west to work part of the hitherto incomplete "S" line eastwards with "S2550" (2100-2200) and "S2250" (0000-0120; intercalibration samples). For most of the day there had been a stiff breeze from a northerly quarter, choppy seas and restricted working on deck while under way.

19/6/97 (JD170) With conditions easing, the pre-dawn cast for primary production was carried out at "S600" (0300-0335) followed by zooplankton and phytoplankton net hauls (0335-0350) and passage to the western end of the "S" line for the deep "oceanic" cast "S2600" (0755-0955) with samples to help define the oceanic water masses present. Course was then made to the western end "R2500" of the 42°20'N section, where a CTD cast (1150-1325) and phytoplankton net haul (1335) completed the "R" line. RRS *Charles Darwin* then continued to the most western of the remaining stations on 42°30'N. CTD casts were carried out at "Q2000" (1535-1705), "Q1500" (1800-1910), "Q1000" (2015-2110) and "Q136" (2220-2235) followed by zooplankton and phytoplankton net hauls (2320-2330).

20/6/97 (JD171) The primary production CTD cast was carried out at the easternmost "Q" line station "Q100" (0055-0125) where the CTD struck a protrusion from the bottom at less than 80m down in water depths generally exceeding 100m. Ill effects were limited to one Niskin bottle lost and another damaged. Then rendezvous was made with *Belgica* to both carry out a CTD station at nearly the same position "Q600" and time (0330-0415). RRS *Charles Darwin* (finishing slightly earlier) then preceded *Belgica* to shelter off Vigo to receive and transfer samples, plots, the spare CTD part and four Niskins for RRS *Discovery* by means of *Belgica's* Zodiac (0705-0715). After testing lifeboats, RRS *Charles Darwin* then headed into increasing swell for the ADCP site near "P200", where immediate contact with the acoustic release enabled three (repeat) positions for CTD casts on the "P" line. These proceeded cautiously in the 5m swell at "P200" (1220-1250), "P500" (1350-1420) and "P1000" (1505-1555) after which course was made to Southampton.

Recording of underway sampling measurements (shipborne ADCP) ceased at 1515 (1715) day 174, and RRS *Charles Darwin* arrived at Empress Dock, Southampton at 0840 on day 175.

5. TECHNICAL REPORTS

5.1 Swath bathymetry (D. Booth and R. Pearce)

The Simrad EM12 Multibeam system used is a low-frequency multibeam echo sounder with full ocean depth capability. The EM12S-120 as fitted to RRS *Charles Darwin* has an angular coverage of up to 120° giving a maximum swath width of 3.5 times the water depth. The system is run with the 81 beams set for equidistant horizontal range.

No problems were experienced with the system during the cruise. Problems of locking up and losing control on the OPU experienced on previous cruises seem now to have been fixed with the new versions of the software.

Like the 3.5 kHz, the EM12 was run through most of the cruise, being set to standby only while the IES was being deployed and recovered and during four "quiet" periods while coring on day 154.

A sound velocity profile using the svp16 probe was carried out at the beginning of the cruise and, weather permitting, XBTs were carried out each day (eight in total were possible). The surface sound velocity probe (OTS) was installed prior to the cruise. After an initial problem of a closed valve, it worked satisfactorily during the cruise. The problems of air becoming trapped in the tank in bad weather have now been rectified with the repositioning of the tank.

The sidescan recorder locked up and approximately 15 hours of the paper record were lost. However, this did not affect the data which were still being logged.

Sound Velocity Profile

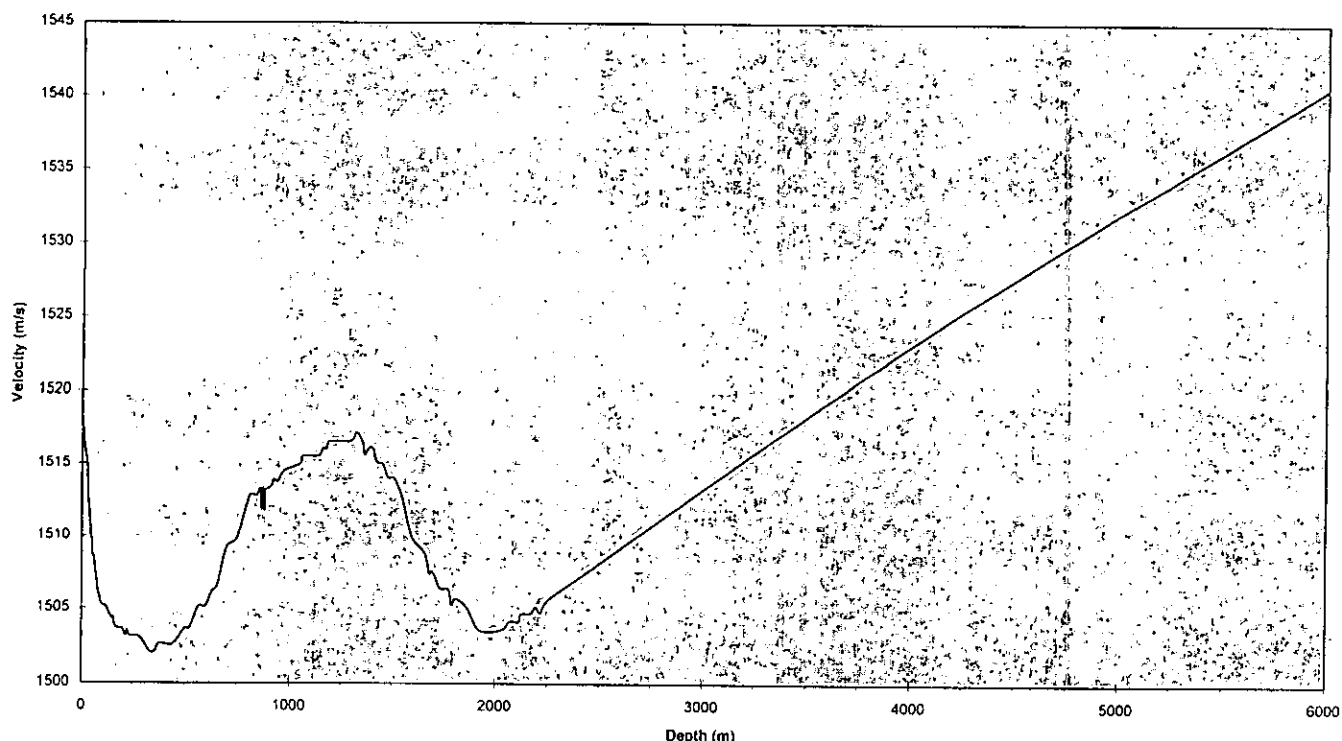

The multi-beam data were processed using the Neptune processing software suite, as supplied by SIMRAD and Geomatic. The software was used to remove spikes and erroneous sounding from the data set before it was processed to produce gridded depth files. Processed navigation from the RVS ABC was also fed in as part of the processing procedure.

A 100m grid file was produced to cover the whole of the survey area; 50m grid files of shallower subsections in the eastern part of the survey area were also generated. A two times SD (standard deviation) statistical filter was used as part of the gridding process. The grids were then statistically smoothed using a custom regridding algorithm.

A number of north-south artefacts are visible on contour plots covering the deeper western part of the survey. This noise occurs where the outer beams from two different survey lines overlap and may be removed by further statistical cleaning and editing.

The final smoothed 100m gridded files were then used to produce a variety of contour and colour contour plots. Copies of the swath data in its raw and various processed forms will be passed to BODC.

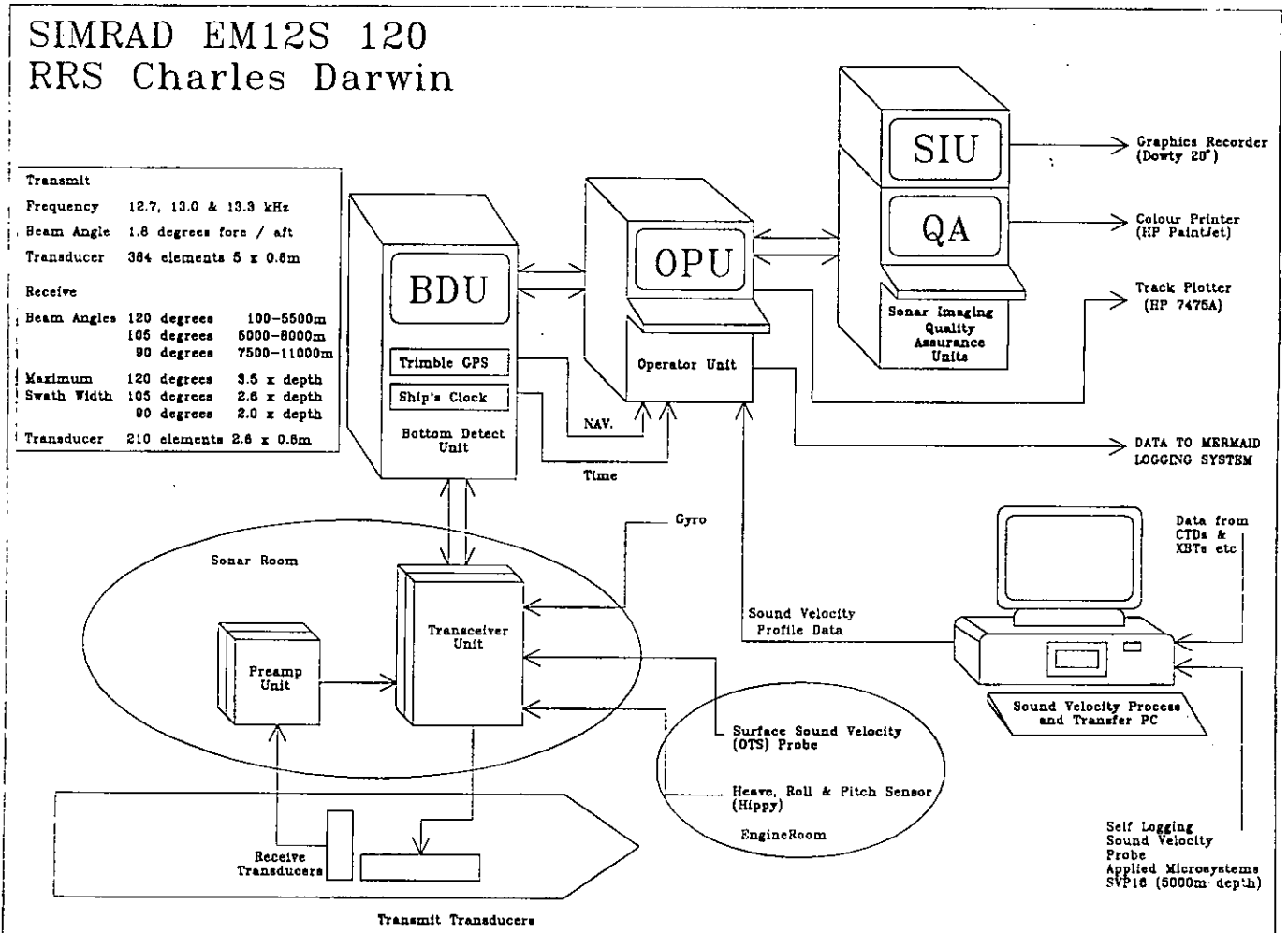

5.2 3.5 kHz sounder (D. Booth) and EA500 sounder (D. Teare)

The 3.5kHz echo sounder uses a chirped pulse between 3 and 4 kHz. The return echo is then correlated to produce a paper record. This record is annotated with the cruise number and the time.

This was run throughout most of Leg A, being switched on 0600 JD150 (30th May). It was turned off for the deployment of the IES, during the recovery of four cores allowing a "quiet" period for the IES and during the recovery of the IES. No problems were experienced during the cruise except when approximately four hours of record were lost due to the transmitter being left in standby after a range change.

The EA500 echo sounder was run on Leg B for bottom depth and CTD bottom separation. No problems were experienced.

5.3 Box coring (I. Hall, C Fogwill and P L'Henoret)

Coring Operations.

Sediments are often the ultimate repository of many elements in the oceanic system. Much of the fine sediment escaping from the Iberian shelf system is probably entrained in the Eastern Boundary Current (of Lower Deep Water from the south), and at shallower depths by the Mediterranean Outflow Water, and is eventually deposited in sediment drifts along this margin. The upwelling regime bringing nutrient-rich deep waters to the surface drives high primary productivity, suggesting that this area exports significant amounts of organic matter to the open ocean and seabed of the continental slope and rise. The record of and proportion of organic carbon accumulation will be influenced by remineralisation, preservation by varying sediment mass accumulation rate, variation in productivity and bottom sediment redistribution. There is however a substantial gap between hypothesis and data with regard to the interplay between open slope and canyon- influenced across slope transport, and present and recent (Holocene) variability in upwelling controlling C_{org} to the sediment.

Box Coring:

We took a total of six box cores with a NIOZ box corer equipped with a circular bucket. The entry speed was initially set at 30m/min but at station OMII-1B and OMII-2B the core slightly over penetrated the bucket. We therefore reined back to 15m/min and adjusted the stoppers on the corer which provided adequate penetration. On the second deployment at station OMII-1B the box corer failed to trigger. This problem was addressed by shortening and therefore increasing the sensitivity of the firing arm. Core OMII-5B was slightly washed down through a crack in the upper sediment and horizontally along a coarse dark brown unit of ~ 1 cm thickness at a depth of ~15 cm. The standard sampling was: two 10 cm diameter drainpipes (Ian Hall), two surface scrapes (~0.5 cm) for benthic foraminifera (Ian Hall) and diatom (R.Bao) species abundance. Sub-samples taken by Cambridge will be analysed for total, organic and carbonate carbon content. The use of short-lived radioisotopes (^{210}Pb and ^{137}Cs) will be used to determine biological mixing depths.

By using selected isotopes with different half lives, we will focus on the characterisation of the sedimentation pattern of the studied area on:

- short-time scale: with a multitracer approach (i.e. $^{234}\text{Th}_{\text{xs}}$, $^{228}\text{Th}_{\text{xs}}$, $^{210}\text{Pb}_{\text{xs}}$ and ^{137}Cs), we will better constrain the determination of the bioturbation rate coefficient, and in particular test the

assumption of a steady state at the sea-sediment interface. Sampled box cores : 2B, 3B, 4B, 5B, 6B, 8B, 9B. On board, each box core was sub-sampled, sliced each 1 cm from 0 to 10 cm, then each 2 cm in the deeper part of the core. At the laboratory, sediments will be dried, then radionuclides of interest will be measured by direct low background, high efficiency gamma spectrometry.

- long-time scale: sediment accumulation rates can be assessed using ^{230}Th and ^{231}Pa in excess dating method, applied to sediments collected by the Kasten corer. Kasten sediments will be sampled within the year.

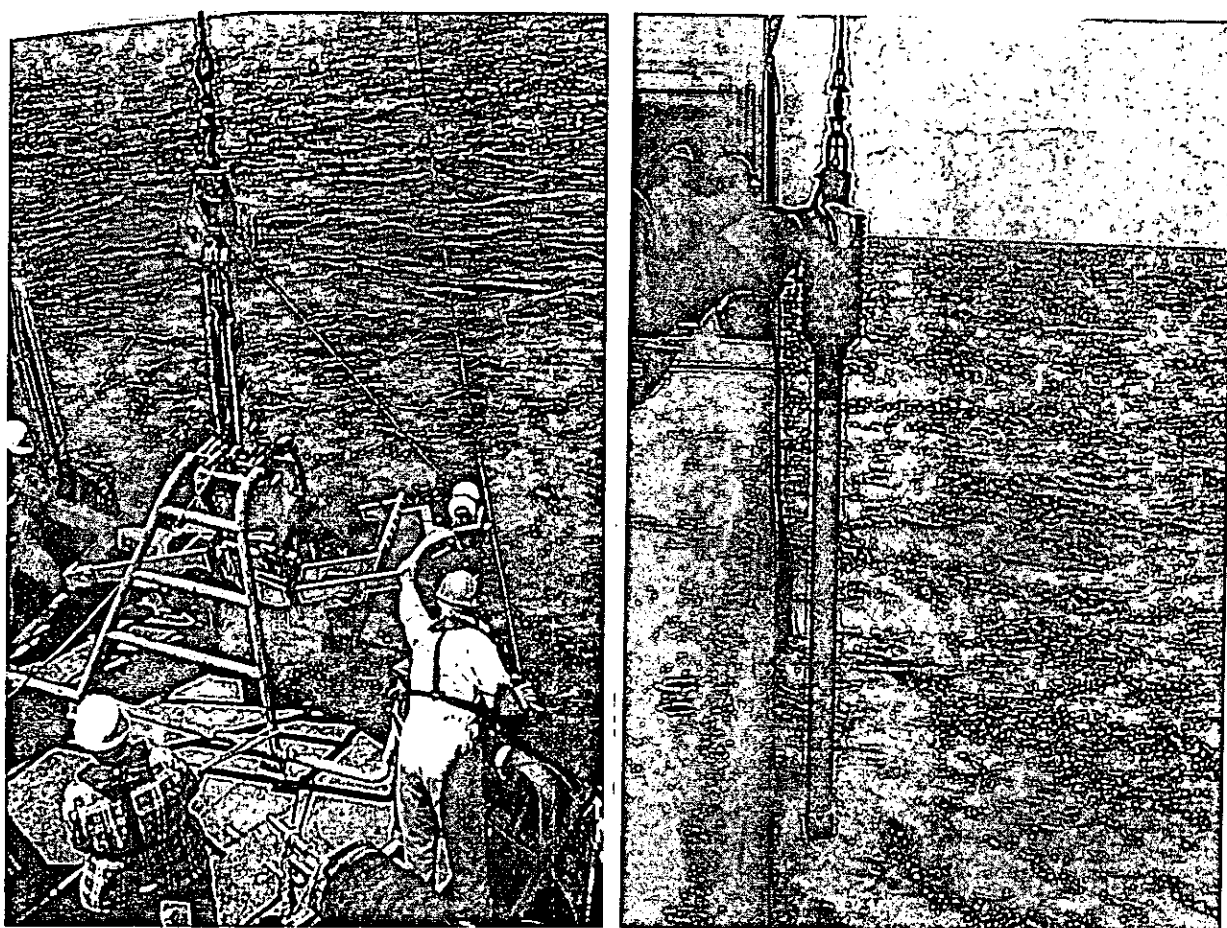

5.4 Kasten coring (I. Hall and C. Fogwill)

The following Kasten cores were obtained using the 4 m Cambridge barrel on a 1 tonne core head. Cores were named to coincide with box cores taken at the same sites.

OMII-1K failed to penetrate

OMII-2K recovered a sloppy olive coloured sandy silt at the top suggesting only slight loss of the surface. A total of six units were identified giving a total length of 180 cm.

OMII-3K recovered a total of 7 identifiable units giving a total of 300 cm.

OMII-4K failed due to tension coming off the wire at the time of penetration.

OMII-5K recovered a total of 13 identifiable units giving a total length of 353 cm.

OMII-9K recovered a total of 10 identifiable units giving a total length of 350 cm.

Sub-sampling of the Kasten cores was carried out using moulded styrene trays (330*15*25 mm)

and syringe samples every 4 cm for water contents. A total of three slabs were taken for each core. The slabs were sealed in plastic and stored at 2°C.

Bulk magnetic susceptibility was measured on board every 2 cm downcore using a Bartington Instrument MS2 meter with a 'probe'-type sensor held against sediment slabs. Measurements were carried out in the constant temperature laboratory at 10°C. A plot for core OMEXII-5K is shown in the figure. Variation in magnetic susceptibility in deep sea sediments reflects changes in lithology, such as the ratio of biogenic to lithogenic components, and therefore provides a rough guide to concentrations of terrigenous material.

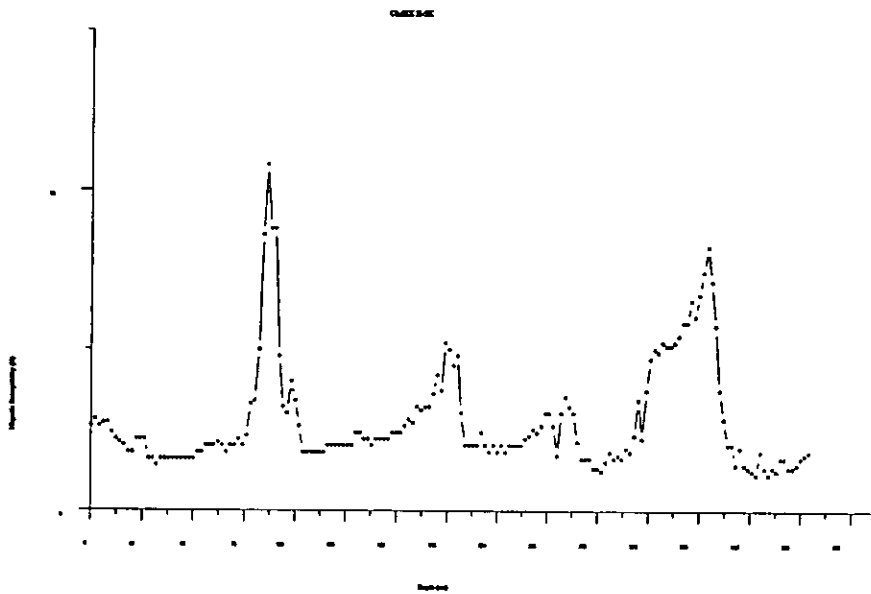

One set of slabs provides adequate material, sampled at 1 cm slices, for sedimentology, geochemistry and micropalaeontology requirements by groups at Cambridge. Analyses will be made of water content, size fractionated magnetic susceptibility, carbonate and terrigenous material content and grain size, organic carbon content, Ti/Al, delta 18O and delta 13C on pelagic and (if sufficient) benthic foraminifera. Material from other slabs will be available for work by other groups on request.

5.5 Inverted Echo Sounder (J. Ashley)

The inverted echo sounder (IES) mooring was fitted with two acoustic transponders operating two release mechanisms: a 14KHz unit connected to a gas retractor release (with a maximum deployment depth of 1500m) and a 13.5KHz unit connected to a burnwire release. It was set to take 1 sample of 5.4s length every 300s at a sampling rate of 42KHz. A radio beacon was fitted to assist with location during recovery. The IES was deployed in approximately 1350m of water at 42°23.19'N 9°29.49'W on 31/5/97, 09-17. Acoustics were tested while the unit was submerged prior to release, and the instrument monitored on its descent using the 14KHz transponder. Following completion of the descent, taking 33 minutes, communications with the 13.5KHz transponder were checked. Recovery took place on 8/6/97. The ship was stationed about 200m from the deployment site, and communications established with both transponders. The mooring

was signalled to release at 09-53, using the burnwire, and ascent began after about 6 minutes. The distance from the ship was monitored using the 14KHz transponder for 21 minutes, at which point the distance of about 450m stopped decreasing, indicating the unit was on the surface. It was quickly seen from the ship and recovered. During recovery the radio beacon was lost. The data from the instrument has not yet been examined, but seems to be as expected.

5.6 ADCP mooring (M. White)

As part of the OMEX II-II mooring line, UCG are charged with the deployment of two moorings close to the shelf break and upper slope. The first mooring element is a bottom-mounted ADCP, used instead of a conventional mooring for added protection against trawling activity. This mooring was deployed on 10th June at 42°40.94'N 9°28.58'W in a water depth of 156m. The instrument has a free-fall bottom mounting which was deployed and lowered into the water and released using a quick-release hook. It would have been preferable to have lowered the mounting to close to the seabed and released the package with an acoustic release instead of the slip hook. Weather conditions, however, did not allow this option. The ADCP will measure at 30min intervals in 4m bins up to about 100-110m above the seabed, with the first bin at 6m. Immediately after deployment, no response was received from the acoustic release; this may have been due to the bad weather producing too many bubble clouds around the ship's hull, hindering acoustic propagation from the acoustic transducer lowered from the ship. Interrogation of the mooring 11 days later, however, proved successful when stationed at the release site. The range indicated by the release indicated little movement from the release site due to drift in the free-fall descent.

5.7 Current meter line mooring (M. White)

The second mooring was a conventional sub-surface mooring with four current meters. This was deployed on 10th June (like the ADCP) in a water depth of 686m. Release location was 42°40.1'N 9°34.4'W. The current meter depths and serial numbers are as follows:

<i>Current Meter</i>	<i>Depth</i>
11217	666m
11218	586m
10727	386m
11213	236m

Deployment proceeded satisfactorily and the deck crew worked well for both deployments. One criticism would be the lifting of the main buoy from the bottom and not the top lifting ring. This caused the buoy to flip over and almost damage the ARGOS beacon protruding from a bracket. There was some problem deploying the last section with bottom current meter/release and weight elements. This would have been addressed beforehand with more discussion prior to deployment. Data will record hourly and it is planned to service the mooring in January 1998 on the next OMEX cruise on RRS *Charles Darwin*.

5.8 Ship-borne ADCP (D. Teare)

The system was run on leg B using the "standard" RVS configuration of 4 m bin lengths and a 5-minute ensemble. No problems were experienced.

5.9 Underway recording and sampling (D. Teare)

On leg A, the thermosalinograph (TSG) and PAR light sensors were recorded. Initial checks of the TSG showed erratic results, the system was checked and the fault rectified (see below). The starboard PAR sensor was changed due to a fault.

On leg B, in addition to the above, the transmissometer and fluorometer sensors were recorded. The transmissometer was swapped with the CTD unit when the latter developed a problem.

TSG problem. Initial salinity checks showed erratic readings on the TSG salinity. This problem was traced to the flow direction through the system housing. The temperature sensor was downstream of the conductivity cell whereas it should be upstream (to compensate for the different time responses of the sensors). The housing was inverted and the results became more consistent.

5.10 CTD (D. Teare and P. Howarth)

The CTD profiling system worked throughout leg B but the bottle firing rosette gave problems on a number of occasions causing loss of time (see below). One transmissometer was changed due to a pressure-related fault. The second transmissometer, PAR light sensors, fluorometer and light-scatter sensor worked without problem.

CTD rosette system failures. On cast 2 the bottles failed, the CTD was recovered, the connectors were checked and the system started to work again. Cast 3 was successful. On cast 4 the problem reappeared. The CTD was brought back on board and the rosette pylon was replaced by the spare; this worked satisfactorily for a short period on deck but then developed a short circuit; this short circuit was traced to the "tone fire" electronics board but could not be located on the board. The original "tone fire" electronics board was taken apart and the connections cleaned and fitted into the spare rosette pylon. The system then worked without serious fault until cast 63 when the problem reappeared. The CTD was brought on board and the connections checked, the system started to work and gave no further problems until cast 78 when once again the bottles failed to fire. The CTD was retrieved, the electronics were powered down, then powered up and the fault disappeared. The system was then left powered up for the remainder of the casts without problem.

5.11 Satellite imagery (J. Huthnance)

Images were received for June 4 and June 8 prior to leg B. These showed that the storm on 5-7 June had largely removed the sea-surface temperature patterns of 4 June (when scales of order 20 km were evident offshore) to leave just a consistent band of warmer water within O(20km) of the coast. Images for the afternoons of June 14 and June 17 showed warmer surface water in a continuous coastal band, width O(20km, 30 km respectively) and "bulging" somewhat further offshore in some places than others. *In situ* measurements suggested that this was associated with fresher "greener" water, *ie.* a plume. A subsequent image for the early morning of June 18 showed a thin O(5km) band of water close inshore, the warm band O(40km) wide and the ocean beyond. The thin inshore band was at a similar temperature to the ocean, especially north of Porto in association with the coastline trending west of north. It may have been the result of further freshwater input or forcing of the warm plume offshore by the northerly winds of the previous day and evening (more probably, in view of the association with coastal trend).

The images, together with visual and thermosalinograph observations of the plume and its offshore front, encouraged underway nutrient sampling, especially on JD 166, for subsequent correlation with sea-surface temperature (qv. 5.12). Their lack of other structure encouraged a decision to dispense with diagonal ship's tracks between the cross-shelf sections, which had been envisaged to give more detailed surface coverage along-shore.

5.12 Nutrients and intercalibration samples (A. Pomroy)

Inorganic nutrients. Nutrient concentrations were determined using a 5-channel, Technicon autoanalyser system set up to measure nitrate, nitrite, phosphate, silicate and ammonia. Discrete samples were taken from all pre-dawn, primary production CTD casts and from all midday shallow casts when the upwelling and downwelling PAR sensors were fitted to the CTD. At stations S90, S200 and S2250 samples were taken from each CTD bottle, filtered through acid-washed, 0.45 micron, cellulose nitrate filters and five replicate subsamples taken as an intercomparison between Plymouth Marine Laboratory and Belgian and Spanish colleagues. One replicate was analysed immediately on board and the other four frozen for subsequent analysis. Of these, 3 were transferred to the Belgica during the rendezvous on 20 June and the fourth will be analysed at PML. During the rendezvous a further 24 samples were taken during simultaneous CTD casts by both vessels at station Q600 and replicate subsamples analysed immediately on board both ships. All determinations were completed successfully, although the measurement of ammonia concentration was hindered by contamination of the ships Milli-Q system, which prevented the establishment of a reliable baseline. This will be resolved when samples of Milli-Q water are analysed at PML.

A list of CTDs at which discrete samples were analysed follows.

<u>Date</u>	<u>Station</u>	<u>Date</u>	<u>Station</u>	<u>Date</u>	<u>Station</u>
12.06.97	N2000P	12.06.97	N3300	13.06.97	O140
13.06.97	P200	13.06.97	P1000	13.06.97	P2000
14.06.97	Q2500	15.06.97	V2600	15.06.97	V160
16.06.97	U200	16.06.97	T2500	17.06.97	T200
17.06.97	S90	17.06.97	S200	18.06.97	R1000
18.06.97	R200	19.06.97	S500	19.06.97	S2250
19.06.97	S2600	20.06.97	Q100	20.06.97	Q600

Underway nutrient analyses. A limited number of underway nutrient analyses of surface waters were performed, using the vessels non-toxic supply, during transects which crossed from lower salinity, coastal, surface waters into more saline offshore waters, in order to attempt to establish a relationship between surface temperature and nitrate concentration in collaboration with colleagues at the NERC remote sensing unit at PML. Times and durations of underway analyses are as follows:

15.06.97	1600	to	15.06.97	1900
15.06.97	1917	to	16.06.97	0229
17.06.97	0709	to	17.06.97	1158
17.06.97	1327	to	17.06.97	1537
18.06.97	0949	to	18.06.97	1144
18.06.97	1302	to	18.06.97	1452

5.13 Phytoplankton and "new" production, ammonia regeneration and nitrification (A. Rees and A. Pomroy)

Objectives: To determine the rates of:

- primary production by different size fractions of phytoplankton.
- the uptake of ammonia and nitrate by phytoplankton.
- heterotrophic ammonium regeneration.
- bacterial nitrification.

Methods. Primary production was measured on water samples taken from eight depths in the surface mixed layer by measuring the incorporation of ^{14}C bicarbonate into three size fractions: $>5\mu\text{m}$, <5 to $>2\mu\text{m}$ and <2 to $>0.2\mu\text{m}$. The samples were incubated on deck, with a series of blue optical screens to simulate the light profile in the sea. All incubations began just before dawn, with 24h duration.

The assimilation of ammonia and nitrate was measured on samples taken from the same depths as the primary production experiments and also incubated on deck for 24h with ^{15}N ammonia and ^{15}N nitrate. In addition a shorter incubation (4 - 6h) was performed at each station from three selected depths to determine a linear uptake rate; the filtrate from which was collected in order to determine the ammonium regeneration rate by an isotope dilution approach.

Nitrification, the bacterial oxidation of ammonium to nitrite and nitrate was estimated by two methods from three depths throughout the upper 120m. Both involved measuring the rate with and without the addition of a nitrification inhibitor - allylthiourea (ATU), the first involved incorporation of ^{14}C labelled bicarbonate over six hours whereas the second method measured a change in the relative concentrations of dissolved inorganic nitrogen (DIN); ammonium, nitrate and nitrite over 24h.

In support of the rate estimates 8 - 10 samples were collected from the upper 100m for analysis of the size fractionated chlorophyll concentration, and 1 - 2 samples were preserved in Lugols solution for later analysis of the phytoplankton species composition. Sampling activities are summarised below in the table.

Results. No data is currently available, 2- 4 months is required before all of the collected samples have been analysed. Following in-house quality control the data will eventually be logged at the B.O.D.C.

Thanks to all those onboard who assisted in some way in our day to day routine; and in particular to Rosa Barciela whose help certainly made our life a lot more manageable.

Table. Summary of activities

<i>Station</i>	<i>Date</i>	<i>Activity</i>
N2000	12 June	24h N assimilation and C fixation <6hr N assimilation/ NH_4 regeneration (10, 20 & 60m) nitrification - ^{14}C and DIN (20, 60 & 100m)
O140	13 June	24h N assimilation and C fixation <6hr N assimilation/ NH_4 regeneration (10, 20 & 50m) nitrification - ^{14}C and DIN (20, 50 & 100m)
Q2500	14 June	24h N assimilation and C fixation <6hr N assimilation/ NH_4 regeneration (10, 20 & 60m) nitrification - ^{14}C and DIN (20, 60 & 100m)
V2600	15 June	24h N assimilation and C fixation <6hr N assimilation/ NH_4 regeneration (10, 45 & 80m) nitrification - ^{14}C and DIN (45, 80 & 120m)

U200	16 June	24h N assimilation and C fixation <6hr N assimilation/NH ₄ regeneration (10, 35 & 60m) nitrification - ¹⁴ C and DIN (35, 60 & 100m)
T200	17 June	24h N assimilation and C fixation
R1000	18 June	24h N assimilation and C fixation <6hr N assimilation/NH ₄ regeneration (10, 30 & 50m) nitrification - ¹⁴ C and DIN (30, 50 & 100m)
S600	19 June	24h N assimilation and C fixation <6hr N assimilation/NH ₄ regeneration (10, 35 & 60m) nitrification - ¹⁴ C and DIN (35, 60 & 100m)
Q100	20 June	24h N assimilation and C fixation <6hr N assimilation/NH ₄ regeneration (10 & 20m) nitrification - ¹⁴ C and DIN (20 & 67m)

5.14 Phytoplankton chemotaxonomy using chlorophyll and carotenoid pigments

(D. Cummings)

Introduction. In biological oceanography the photosynthetic pigments, in particular Chlorophyll *a* are recognised as unique and convenient markers of phytoplankton biomass. Although spectrophotometric and fluorometric techniques are widely used to determine biomass, the utilisation of high performance liquid chromatography (HPLC) not only permits a more accurate measurement of Chlorophyll *a*, but also allows simultaneous separation and quantification of a range of other chloropigments and carotenoids in marine phytoplankton.

Determination of pigments by HPLC. Water samples (~2000ml) were filtered through glass fibre filters (GF/F). Filters were stored under liquid nitrogen (-196°C) to be later analysed at the Plymouth Marine Laboratory.

The phytoplankton harvested on the filters will be extracted using 90% acetone with ultrasonification. Ammonium acetate buffer will be added in equal volume and chloropigments and carotenoids in the extract resolved by binary reverse-phase HPLC with absorbance detection (440nm) on a 10cm C8 column using a programmed gradient elution with methanol:ammonium acetate (70:30) and methanol mobile phases.

Cruise objectives.

(1) To track the varying concentrations of chlorophyll and carotenoid pigments along the Iberian coast.

(2) To determine particulate calcite and silicate concentrations in coincident filters and examine the relationship between their concentrations and those of fucoxanthin (marker for diatoms) and 19'-hexanoyloxyfucoxanthin (marker for prymnesiophytes).

For calcite ~1000ml of water was filtered onto GF/F. For silicate ~400ml was filtered onto polycarbonate filters.

Pigment chemotaxonomy. Many species of phytoplankton have strong chemotaxonomic associations, through which it is possible to obtain an understanding of the taxonomic composition of the overall phytoplankton biomass.

There is increasing evidence that each species of phytoplankton interacts in a unique way with the biotic and abiotic environment and in doing so exerts a unique impact on ocean chemistry and biogeochemical cycling.

<i>Pigment</i>	<i>Taxonomic class</i>
Chlorophylls	
<i>Chlorophyll a</i>	Total biomass
<i>Chlorophyll b</i>	Chlorophytes/prasinophytes
<i>Chlorophyll c1c2</i>	Diatoms
<i>Divinyl chlorophyll a</i>	Prochlorophytes
<i>Divinyl chlorophyll b</i>	Prochlorophytes
Carotenoids	
<i>Alloxanthin</i>	Cryptophytes
<i>Fucoxanthin</i>	Diatoms
<i>19'-Butanoyloxyfucoxanthin</i>	Chrysophytes/pelagophytes
<i>19'-Hexanoyloxyfucoxanthin</i>	Prymnesiophytes
<i>Peridinin</i>	Dinoflagellates
<i>Zeaxanthin</i>	Cyanobacteria/Prochlorophytes

5.15 Dissolved Organic Carbon Production (R. Barciela)

Objective: to characterise vertical variability in the phytoplankton dissolved organic carbon (DOC) production.

Methods: water samples collected from the Niskin bottles at 3-4 depths at each pre-dawn CTD station were used for conducting DOC experiments.

DOC production. At three depths on each station in the Atlantic area triplicate water samples, for the determination of DOC production, were contained in 30 ml glass bottles, spiked with 35 $\mu\text{Ci NaH}^{14}\text{CO}_3$ and incubated in an on-deck incubator. The incubator was equipped with a set of filters providing a range of eight irradiances from 100% to 1% of I_0 . Each sample was incubated at an irradiance level close to the original irradiance experienced by phytoplankton cells. Incubations typically started in the morning (about one hour after sampling) and lasted for two or three hours. At the end of the incubation 8 ml of each bottle were filtered by glass microfibre filters (GF/F). The liquid after filtering was acidified with phosphoric acid to pH 2. For a period of 24 hours the samples were stirred for removal of inorganic ^{14}C , and 12 ml scintillation cocktail was added to each vial. The GF/F filters were exposed for 12 hours to concentrated HCl fumes for removal of inorganic ^{14}C . Finally the filters were placed in scintillation vials, 3.5 ml scintillation cocktail added to each vial for later determination of radioactivity using a scintillation counter. Samples in sequence were:

<i>Station</i>	<i>Depths (m)</i>
N2000P	5, 10, 60
O140	5, 20, 50
Q2500	5, 20, 60
V2600	5, 60, 80
U140P	5, 30, 60, 100
T200	5, 20, 45, 60

R1000	5, 25, 40, 50
S600	5, 35, 60
Q100	5, 20, 40

5.16 Bacterial production and biomass (A. Pomroy)

The rates of production of heterotrophic bacteria were determined by two related radiochemical methods; the incorporation of methyl-³H-thymidine into nucleic acid, which is an indicator of replication rate and the incorporation of L-³H-leucine into protein, which is an indicator of growth rate. All incubations were conducted at in-situ temperatures in a purpose-built incubator capable of up to 24 different temperatures. All depths from all pre-dawn, primary production casts were analysed, with the exception of Stations T100 (17.06.97) and Q100 (20.06.97) when nutrient intercalibration exercises were being conducted. A total of 570 samples were successfully incubated and stored for subsequent laboratory analysis. Glutaraldehyde-fixed replicate samples were taken and frozen from each CTD bottle used for bacterial rate measurements. Bacterial numbers and biovolume will be determined using epifluorescence microscopy and image analysis respectively on these samples.

5.17 Microzooplankton (D. Cummings)

Microzooplankton. ~500ml of water was collected in 1% acid Lugols for the subsequent determination of total microzooplankton biomass and species composition.

Autotrophic and heterotrophic nanoplankton.

Microscopic analysis can be used to determine both the community structure and the biomass of autotrophic plankton. However, using traditional light microscopy and the Utermohl method, autotrophic flagellates in the 20µm size category cannot be differentiated from heterotrophic forms. Autotrophic cells are separated from heterotrophs by the presence or absence of chlorophyll within the cell visible when excited with blue light. As fixation in Lugols destroys any cells any fluorescence alternative methods for the observation of these cells must be used.

The most appropriate method for doing this involves epifluorescence microscopy and the preparation of microscope slides. An aliquot of sample, usually 30-50mls, is fixed in 0.3% glutaraldehyde, stained with 4'6 diamidino-2-phenylindole (DAPI) and proflavin (final concentration 5µg/ml), mounted onto 0.4µm black polycarbonate filters and frozen at -20°C. Observation of slides under blue light excitation allows the differentiation of autotrophs from heterotrophs based on the presence of red chlorophyll autofluorescence. Organisms can be separated into cyanobacteria, various cryptomonad, various sizes and species of dinoflagellates and other flagellates.

5.18 Natural radionuclides (S. Schmidt)

Estimate of vertical particle fluxes :

The use of ²³⁴Th ($t_{1/2} = 24$ d) deficiency relative to ²³⁸U can provide an estimate of the particle export from surface waters. The determination of ²³⁴Th/ ²³⁸U activity ratio over the studied area will bring an overall view of the spatial variability of particle fluxes.

For that, a vertically integrated sample between 10 m and 50 m was taken at most of the stations on N, P, V and S lines :

N100, N220, N1600, N2300, 2000, N3100, N3300
P100, P200, P1000 , P2000, P2900

V75, V160, V1150, V2200, V3100
S130, S200, S1000

Three vertical profiles (S2550, V2800, P2250) were established between 0 and 100 m, to detail the vertical distribution of ^{234}Th , in particular to define if ^{234}Th reaches equilibrium with ^{238}U below 50 m depth.

Moreover two integrated samples were repeated at stations P200 and P1000 at the end of the cruise, to estimate time variability of ^{234}Th deficiency.

Each seawater sample was filtered through a $0.45\ \mu\text{m}$ filter. After addition of ^{229}Th yield tracer and Fe carrier, separation of dissolved ^{234}Th from its ^{238}U parent was carried out on board by passage through an anion exchange column, within 24 hours after seawater collection.

Within two months after the cruise, particulate ^{234}Th will be directly measured on the filter with a low background-high efficiency γ detector. Back in the laboratory, purification of dissolved ^{234}Th will be achieved by a second passage through a column under 8N HNO_3 . Chemical yield will be determined by α -counting of ^{229}Th , and dissolved ^{234}Th activities by γ -counting.

5.19 Suspended particulate matter (I. Hall)

Transmissometry and Light Scattering Measurements

Two 0.25m path-length Sea Tech transmissometers and one SeaTech light scattering sensor (LLS) were mounted in the frame carrying the CTD and rosette sampler. Initially the transmissometers were RVS units 79-D and 80-D, however unit 79-D showed substantial pressure offset and was replaced with unit 116-D after cast 15. The transmissometers operate with light at 660 nm wave length and the LLS at 880 nm. The operation and performance of the SeaTech transmissometer in nepheloid layers has been previously detailed (e.g. McCave, 1983, Spinard *et al.* 1983, Bishop, 1986). The performance of the LSS is presently unknown, it projects light into the sample volume using two modulated light emitting diodes. The light scattered from the suspended particles in the sample volume is measured with a solar-blind silicon detector. The detector is separated from the light source by a light stop to ensure only scattered light is measured.

A total of 94 profiles were made. Initial comparison between the results of the three instruments are favourable with systematic variation through regions of high and low optical turbidity being recorded by each. Open path air voltage was measured prior to each cast and will be used to investigate instrument stability.

Suspended Sediments:

Water samples were collected to determine the concentration of suspended particulate material gravimetrically (allowing empirical calibration of the transmissometers and LLS) and to examine the composition of suspended particles using scanning electron microscopy. Sampling was carried out in regions of high optical turbidity and intervening clear waters at a total of 43 depths from 31 CTD stations.

Samples were collected using 10l Niskin bottles mounted on the CTD rosette. The suspended particles in 20l seawater samples were collected by filtration, under clean conditions, through pre-weighed (to 10^{-6} g) $0.4\ \mu\text{m}$ poresize, 47 mm diameter polycarbonate (Cyclopore) membranes. The membranes were rinsed with 5x25 ml MQ-water to remove seasalt, air dried and stored in

sealed polystyrene petri dishes awaiting laboratory analysis. All critical handling steps were carried out within a Class-100 laminar flow hood

In addition to the above, 2l subsamples from 10m depth at each station were filtered through pre-combusted GF/F filters for particulate organic carbon analysis. These data will be used to investigate discrepancies in the near surface profiles of optical transmission and light scattering.

Cast	Station	Depth (m)	Filter	Volume Filtered (l)
1	P1000	740	0133	17.91
1	P1000	655	0137	18.86
14	N1600	1440	0138	21.26
15	N2300	1500	0139	20.96
15	N2300	401	0140	10.51
15	N2300	303	0141	10.5
19	N3300	3327	0142	20.12
21	O2650	2175	0144	20.92
22	O2000	1443	0145	21.52
22	O2000	1020	0146	20.88
23	O1000	981	0147	21.07
24	O175	113	0149	10.20
30	P1000	750	0150	21.25
32	P2000	1495	0151	20.41
33	P2250	2234	0152	20.89
33	P2250	1852	0153	10.42
35	P2800	2803	0154	21.13
38	V3100	3212	0155	20.08
42	V2200	2225	0158	21.02
43	V1150	120	0160	10.4
50	U1000	954	0161	21.00
50	U1000	906	0163	20.96
54	U2800	2801	0162	20.96
56	T2500	1200	0164	20.91
57	T2100	2105	0165	20.84
57	T2100	728	0166	20.96
59	T2000	1616	0167	21.18
59	T2000	560	0168	21.19
60	T1600	1657	0174	10.54
60	T1600	720	0179	8.18
69	S200	210	0176	10.05
70	S600	450	0177	21.14
71	S1000	638	0169	21.18
72	S2000	1315	0175	21.11
79	R600	243	0171	10.46
79	R600	225	0172	FILTER LOST
79	R600	225	0173	10.18
80	R2000	1990	0178	20.92
80	R2000	876	0183	21.26
86	Q2000	401	0184	10.42
86	Q2000	223	0203	10.56
87	Q1500	234	0200	10.68
92	P200	146	0201	10.46
93	P500	481	0202	10.44

Bishop, J.K.B. 1986. The correction and suspended matter calibration of SeaTech transmissometer data. *Deep-Sea Res.* 33: 121-134.

McCave, I.N. 1983. Particulate size spectra, behaviour and origin of nepheloid layers over the Nova Scotian Continental Rise. *J.Geophys.Res.* **88**: 7647-7666.

Spinard, R.W., Zanveld, J.R.V. & Kitchen, J.C. 1983. A study of the optical characteristics of suspended particles in the benthic nepheloid layer of the Scotian Rise. *J.Geophys.Res.* **88**: 7641-7645

5.20 Longhurst-Hardy Plankton Recorder and Zooplankton Net (A. Hirst)

Cruise Objectives: To obtain mesozooplankton samples throughout the Galicia box for quantitative and qualitative analysis of species composition, biomass distribution, and samples for length-weight analyses. Comparisons of two methods of collection.

Methods: Collection of mesozooplankton material using vertical deployment of 200um WP2 nets, sampling from 200m to surface, or to within ~10% of the total water column depth from the bottom when the water column is shallower, or to a depth which does not exceed the combined LHPR tow, when WP2 samples taken to allow method comparisons. Collection using the Longhurst Hardy Plankton Recorder (LHPR) fitted with a 200um mesh filtering gauze, and a sampling interval of 2 minutes, deployed to a maximum depth of ~400m (less when water column shallower). Immediate preservation of all material in a ~5% buffered sea water-formaldehyde solution. Sites at which all sample collection took place are summarised in below and in table 3.

Post cruise analysis will include determination of species composition and abundance using light microscopy (and SEM when necessary). Inter-comparisons of the values produced using the LHPR system with those collected using the WP2. Size distributed biomass will be measured, and in combination with in situ temperatures be used to predict weight-specific growth, production and ingestion demand. Sub-samples of the collections will also be supplied to the OMEX II partners at SAHFOS (Plymouth, U.K.), who will undertake weight analyses on key species. Their eventual aim being to convert abundance data from the Continuous Plankton Recorder (CPR) for this region into estimates of biomass.

<i>Collection Device</i>	<i>Site Name</i>	<i>Sample Depth</i>	<i>Date</i>	<i>Time (GMT)</i>	<i>Night/Day</i>
WP2	N100	0-110m integrated	11/06/97	01:50	N
	N1600#	0-200m integrated	11/06/97	12:30	D
	N2300*	0-200m integrated	12/06/97	00:20	N
	N3300#	0-200m integrated	12/06/97	11:30	D
	O140*	0-120m integrated	13/06/97	02:00	N
	Q2500*	0-200m integrated	14/06/97	01:00	N
	No name#	0-200m integrated	14/06/97	12:15	D
	41.970oN 10.147oW				
	V2600*	0-200m integrated	15/06/97	03:59	N
	U150*	0-130m integrated	16/06/97	02:45	N
	T200*#	0-150m integrated	17/06/97	02:35	N
	S200#	0-160m integrated	17/06/97	13:40	D
	R1000*	0-200m integrated	18/06/97	01:10	N
	S500*	0-200m integrated	19/06/97	03:40	N
	nr. Q100*	0-110m integrated	20/06/97	23:20	N

Table: Summary of zooplankton net collections, including location and time

*Pre-dawn cast collection at same location and date, #WP2 sample at beginning or end of LHPR tow to allow quantitative comparison. For LHPR tows see Table 3.

5.21 Phytoplankton net (M. White)

Vertical hauls, 100m depth to surface with a 20 micron mesh net, for phytoplankton samples were carried out at a total of 22 stations (see table 3). Whilst opportunistic and not really a part of the OMEX experiment, the analysis of phytoplankton species presence/absence and dominance may prove useful for interpreting the pigment data of PML.

5.22 Differential GPS (R. Pearce)

For part of the cruise, specifically during the multibeam swath survey (leg A) and mooring deployments (leg B), the accuracy of the scientific GPS receiver was improved by the injection of Real Time Computing Messages (RTCM) from a reference station based on the Scilly Isles. It is estimated that the application of these corrections improved the practical accuracy of the receiver from 20-50m to less than 5m.

The corrections were received via the ship's INMARSAT satellite communications system using the Racal Skyfix service. There were no detectable unscheduled breaks in the service during the cruise.

5.23 Ship systems (D. Teare; P. Mason, D. Rees, T. Claridge)

On both legs A and B the ship's clocks, winch monitoring, remote cameras etc. worked without problem.

The following covers the winches, gantries and other equipment that the RVS Scientific Engineering Group was responsible for during this cruise.

The sound velocity instrument at the start of the cruise was deployed on the CTD cable via the starboard 'A' frame.

Coring was carried out using the core warp on the main winch and deployed via the starboard gantry.

- The NIOZ box corer was used regularly throughout leg A. Initially, this corer over-penetrated and its travel length was reduced to prevent this reoccurring. Once this had been implemented and a reliable method for lowering it onto the bottom had been established, good cores were then successfully obtained. On a couple of occasions, samples of rock were in the mud being cored; this caused some leakage in the seal at the bottom of the corer bucket. The following three cores after collecting some rock did not seal completely at the bottom and some of the entrapped water escaped. By changing the bucket and sealing plate the final core still had a slight leak.

- The Kasten corer was also used during leg A. It was used with a four-metre barrel for most deployments. The corer was deployed with the auxiliary winch on the starboard gantry, via a bridle that held the corer horizontal. Once outboard the weight was taken on the main winch; the auxiliary winch was disconnected. Recovery was a reverse of the above but assisted by the mid-ship crane to take the load off the barrel on occasions when it was full of mud.

It was observed that both corers oscillated in the vertical by a considerable amount on many deployments. Stopping and allowing the corer to stabilise close to the bottom did not cure these oscillations. The only practical option to overcome this problem was to lower the corer to the bottom slowly and to increase the payout speed to about 50 m/min as soon as the weight started to come off the cable. As soon as all the weight was removed the payout speed was reduced to

15 m/min for about 15 s and then the corer was immediately recovered. This procedure was tedious but necessary to prevent multiple penetrations or being pulled out of the bottom before it had fully penetrated.

The CTD package was used throughout leg B; it was deployed over the starboard gantry on the CTD cable. This cable termination was load-tested to 1.8 tonne. Ninety-four deployments were successfully completed. There was one occasion when the CTD hit what was possibly an outcrop of rock. It was deployed in 82.5 m of water and the CTD was lowered to 15 metres off the bottom, guided by its own pinger. While lowering the last five metres the CTD hit something and the wire angle became noticeably large. The CTD was recovered with the loss of one water bottle and another one being damaged. The final station water depth was 103 metres. On inspection there were many horizontal scratch marks on the CTD frame and on the damaged water bottle. During this deployment the ship had drifted 0.278 miles which logically suggests that the CTD probably drifted sideways into an outcrop; hence, the approach of an obstruction was not detectable on the pinger record.

Many net hauls were conducted using the hydrographic cable over the starboard 'A' frame. These were all successfully deployed and recovered to depths of 100 and 200 metres.

The LHPR was connected to the conducting cable with a conducting swivel. A bush and suitable links had to be manufactured to allow the swivel to be connected to the LHPR to ensure that damage would not be encountered by either. It was successfully deployed from the deep tow conducting cable on the main winch via the aft gantry on six occasions.

The double-barrel winch and the aft crane were used successfully for the deployment of a current meter mooring at the start of leg B.

The Radionuclide Container was used intensely throughout leg B. This container met all the requirements placed upon it by the scientists using it. It was also connected into the ship's water, telephone and alarm systems.

The laminar flow cabinet was used throughout the second leg without giving any problems.

The Milli-Q system was used through the cruise for many purposes. It was noticed that the level of ammonia in the Milli-Q water appeared to be high and this will be investigated.

The non-toxic water system provided non-toxic water to various areas around the ship for many purposes. This system operated reliably for the duration of the cruise.

5.24 Computing (R. Pearce)

The RVS ABC computing system was used during both legs to log, plot and archive data from scientific and navigational instruments. Some basic processing of the CTD, surface sampling and single beam echo sounder was performed to produce plots of CTD downcasts and underway data. Copies of the data will be forwarded to BODC for archiving and further processing.

6. CONCLUSIONS

Swath bathymetry with coring at the end of the swath lines proved to be a good combination with (in this case) an approximately daily cycle being following during the first six days of good working conditions.

The swath bathymetry and 3.5kHz sounder proved very valuable in searching for suitable coring sites with gentle slope and soft deposited sediment. The bathymetry was also very valuable for the choice of mooring sites, and in the P700 mooring deployment by enabling the ship to be steered towards an exact position for releasing the mooring. It proved to be far superior to other information available, which was found to be seriously inaccurate (by hundreds of metres) in some CTD station locations.

RRS *Charles Darwin* proved to be very suitable for the work and conditions on this cruise. As well as being fitted with the multi-beam echo sounder that was so valuable to the work, the starboard gantry position was very stable for the many CTD casts. Wet decks under higher wave conditions did not impose serious delay. Transfer to the hydro' wire for net hauls was quick; the slower transfer to the coring warp was not needed within either cruise leg. The added double-barrelled winch was good for deploying the current meter mooring.

Laboratory space was ample for the work undertaken, except in the container for ^{14}C and ^{15}N work where three people were sometimes working simultaneously on primary production, bacterial production and DOC sample preparations. Location of the echo-sounder and winch control in the main laboratory, port side, does not help quick transfer from outside operation or easy liaison with the CTD control (PC) set up for quick access to the CTD. The wet laboratory was well used but also tended to be a "traffic route".

An altimeter would have speeded CTD profiling down to close to the sea bed.

The "NIOZ" box corer gave several good cores but was not ideal; the circular-cylinder "box" soon lost its shape, although not seriously; the seal by the spade seemed rather prone to disturbance; there was little margin for deploying this large corer (high with a long base) through the slightly offset space available below the starboard gantry.

The Kasten corer at the bottom of a length of paid-out cable has a natural vertical oscillation which is only slightly damped. There was evidence from basic calculation and the winch tensiometer readings that with 2-3 km of wire out this oscillation had a period of about 4 s and thereby the Kasten corer was exaggerating the vertical motion of the ship. It appeared to "bounce" during several coring attempts. Means of damping the natural oscillation might be considered; it is probably difficult to avoid altogether.

For the period 29 May to 13 June the weather was predominantly cloudy with winds from between south-east and west (strong on 5-7 June, otherwise light or moderate only). These conditions did not favour upwelling. Winds became northerly on 14 June, but were only light and became variable or westerly until 17-18 June. Then a spell of (upwelling-favourable) northerlies built up to force 6 but subsided again. Winds were westerly again thereafter.

The overall oceanographic situation in leg B was a thermocline typically at 50 m depth, sharpest

in the deep ocean offshore, more diffuse over the slope and spanning a depth range typically 40-80 m, and more or less mixed waters in depths less than 130 m over the shelf. Surface nutrients were largely depleted (despite the storm on 5-7 June). There was a chlorophyll maximum at typically 60 m, just below the sharpest part of the seasonal thermocline (ie. at a depth where some vertical mixing was indicated) and accompanied by a maximum of SPM as indicated by the CTD transmissometers. Other SPM maxima were often recorded in depths down to several hundred metres, especially near to the steep slope. There was consistently a maximum salinity at a depth 850-1200m indicating Mediterranean water; at two stations there was a double maximum; possibly trends to lower values of the salinity maximum to the west and north. On the inner shelf, there was a surface plume of varied extent, typically 10m deep with fresher, greener water that was also warmer during the day. After the winds of 17-18 June, this appeared to have extended much further, 40 to 80 km offshore in the later-sampled P to R sections. The pre-upwelling condition with depleted surface nutrients appears to have been well characterised.

Table 1. Cores (Julian Day no., depth in m, B denotes box core, K denotes Kasten core)

Name	Time	Day	Latitude N	Longitude W	depth	Comments
(1B)	1428,30/5/97	150	41°47.70'	9°25.08'	886	too deep, surface lost
(1B)	1633,30/5/97	150	41°47.73'	9°25.41'	930	spade did not close box
(1K)	1803,30/5/97	150	41°47.80'	9°25.39'	930	closing flaps not activated
1B	1608,31/5/97	151	41°47.87'	9°24.57'	853	too deep, surface lost
2B	1756,31/5/97	151	41°47.46'	9°26.62'	1109	successful, box nearly full
2K	1939,31/5/97	151	41°47.43'	9°26.90'	1152	successful, ~ 2 m core
(3B)	1550, 1/6/97	152	41°47.52'	9°27.77'	1327	spade did not close box
3B	1746, 1/6/97	152	41°47.31'	9°29.70'	1600	successful, 38 cm core
3K	1952, 1/6/97	152	41°47.18'	9°29.61'	1610	successful, ~ 3.2 m core
4B	1638, 2/6/97	153	41°47.98'	9°50.32'	2535	successful, 33 cm core
(4K)	1912, 2/6/97	153	41°48.07'	9°50.45'	2532	bounced, one flap not closed
(4K)	1543, 3/6/97	154	41°47.89'	9°50.38'	2538	bounced, closed, washed out
(4K)	1754, 3/6/97	154	41°47.83'	9°50.57'	2538	bounced, closed, washed out
5K	2133, 3/6/97	154	41°49.60'	10°01.04'	2723	successful, ~ 3.7 m core
5B	0006, 4/6/97	155	41°49.98'	10°01.13'	2740	~0.3m core, slightly washed
6B	2044, 4/6/97	155	41°48.07'	10°07.11'	2900	successful, 33 cm core
(6K)	2324, 4/6/97	155	41°48.00'	10°06.68'	2892	double penetration (~ 0.5m)
7B	1221, 8/6/97	159	42°19.90'	9°26.37'	434	spade unsealed, ~ 0.1m core
8B	1417, 8/6/97	159	42°19.89'	9°31.53'	1240	~0.3m core, tilted in box
9B	1658, 8/6/97	159	42°19.95'	9°41.91'	1831	37 cm core, surface split
9K	1916, 8/6/97	159	42°19.94'	9°41.92'	1833	successful, ~ 3.5 m core

Table 2 RRS Charles Darwin Cruise CD105B Mooring Information

Station	Date & Time (GMT)	Latitude	Longitude	Depth	Instruments	Owner	Comments
P200	19970610 1240	42 40.9N	009 28.6W	156m	RDI ADCP		
P700	19970610 1741	42 40.1N	009 34.4W	688.5m	RCM8 11217	PML	
	19970610 1754				RCM8 11218	PML	
	19970610 1810				RCM7 10727	RVS	transducer 2568 S/N 10143, cell S/N 2994
	19970610 1837				RCM8 11213	PML	cell S/N 3162
					Argos		ID 1730 S/N 16
					Oceano Rel.		

Table 3 RRS Charles Darwin Cruise CD105B Net Information

Station	Net	Start Date & Time (GMT)	End Date & Time (GMT)	Start Latitude	Start Longitude	End Latitude	End Longitude	Comments
N100	Zoo	19970611 0142		43 00.9N	009 23.5W			
N100	Phyto	19970611 0155		43 00.9N	009 23.5W			
N1600	Phyto	19970611 1205		42 59.9N	009 38.5W			
N1600	Zoo	19970611 1221		43 00.0N	009 38.6W			
	LHPR	19970611 1310	19970611 1519	43 00.0N	009 39.3W	42 59.6N	009 32.9W	
N2300	Zoo	19970612 0025		42 59.9N	009 49.8W			
N2300	Phyto	19970612 0040		42 59.9N	009 49.8W			
N3300	Zoo	19970612 1120		42 59.9N	010 17.3W			
N3300	Phyto	19970612 1138		42 59.9N	010 17.3W			
	LHPR	19970612 1220	19970612 1418	42 59.5N	010 16.8W	42 53.4N	010 16.5W	
O175	Zoo	19970612 2345		42 50.2N	009 29.6W			aborted
O175	Phyto	19970613 0007		42 50.2N	009 29.6W			
O140	Zoo	19970613 0150		42 50.0N	009 23.7W			
Q2500	Phyto	19970614 0042		42 29.8N	010 00.8W			
Q2500	Zoo	19970614 0110		42 29.8N	010 00.8W			
	Zoo	19970614 1210		41 58.2N	010 08.8W			no station
	Phyto	19970614 1225		41 58.2N	010 08.8W			no station
	LHPR	19970614 1240	19970614 1457	41 58.6N	010 09.2W	41 56.0N	010 08.0W	
V3100	Phyto	19970614 2022		41 25.0N	009 57.0W			
	LHPR	19970614 2359	19970615 0115	41 25.3N	009 42.8W	41 25.7N	009 41.2W	
V2600	Zoo	19970615 0352		41 24.8N	009 40.1W			
V160	Phyto	19970615 1129		41 25.1N	009 11.3W			
V55	Phyto	19970615 1511		41 24.8N	008 52.3W			
U150	Zoo	19970616 0302		41 48.1N	010 00.5W			
U150	Phyto	19970616 0310		41 48.1N	010 00.5W			
U2800	Phyto	19970616 1105		41 48.1N	010 04.1W			
T2500	Phyto	19970616 1240		42 00.0N	010 00.2W			
T1600	Phyto	19970616 2341		42 00.0N	009 32.8W			
	LHPR	19970617 0043	19970617 0135	41 59.8N	009 22.3W	41 59.6N	009 20.2W	
T200	Zoo	19970617 0235		42 00.0N	009 17.4W			
T200	Phyto	19970617 0245		42 00.0N	009 17.4W			
S150	Phyto	19970617 1120		42 09.0N	009 08.3W			
	LHPR	19970617 1207	19970617 1258	42 09.5N	009 13.7W	42 10.0N	009 16.0W	
S200	Phyto	19970617 1330		42 08.8N	009 19.6W			
S200	Zoo	19970617 1339		42 08.8N	009 19.6W			
R1500	Phyto	19970618 0015		42 20.4N	009 38.2W			
R1000	Zoo	19970618 0110		42 20.5N	009 29.9W			
R200	Phyto	19970618 1114		42 20.0N	009 17.0W			
R600	Phyto	19970618 1340		42 20.8N	009 27.5W			
S600	Zoo	19970619 0335		42 09.7N	009 26.5W			
S600	Phyto	19970619 0350		42 09.8N	009 26.5W			
R2500	Phyto	19970619 1335		42 20.3N	010 01.4W			
	Zoo	19970619 2320		42 29.6N	009 13.4W			
	Phyto	19970619 2330		42 29.7N	009 13.4W			

Table 4 RRS Charles Darwin Cruise CD105B CTD Information

Cast No.	Station	Start Date & Time (GMT)	Latitude	Longitude	Depth (m)	Comments
1	P1000	19970610 1424	42 40.7N	009 34.1W	808	
2	N30	19970610 2025	42 59.9N	009 18.1W	30	aborted
3	N30	19970610 2255	43 00.0N	009 18.0W		aborted
4						deck test
5						deck test
6	N30	19970610 2350	42 59.9N	009 18.2W	45	bottles fired on down cast
7	N100	19970611 0109	43 00.4N	009 23.9W	126	aborted
8						test
9						test
10	N1600	19970611 1055	42 59.9N	009 37.7W		test
11		19970611 1240	43 00.0N	009 38.9W		test
12	N100	19970611 1629	43 00.0N	009 23.8W	119	
13	N220	19970611 1800	43 00.1N	009 31.0W	212	
14	N1600	19970611 1920	43 00.0N	009 38.9W	1520	
15	N2300	19970611 2138	42 59.9N	009 43.0W	2200	trans 1 suspect
16	N2000	19970612 0050	42 59.8N	009 49.8W	2056	trans 1 replaced
17	N2000P	19970612 0310	43 00.0N	009 48.6W	2080	with light meter
18	N3100	19970612 0550	42 59.9N	010 00.8W	3100	
19	N3300	19970612 0820	43 00.1N	010 17.9W	3339	station renamed from N2800
20	N3300P	19970612 1150	42 59.9N	010 17.3W	3300	with light meter; 200m bottle.
21	O2650	19970612 1600	42 50.0N	009 59.9W	2640	
22	O2000	19970612 1920	42 50.0N	009 46.0W		
23	O1000	19970612 2152	42 50.0N	009 37.7W		
24	O175	19970613 0040	42 50.3N	009 29.5W	178	station renamed from O350
25	O140	19970613 0240	42 50.0N	009 23.3W	140	bottle misfires; was O200
26	O140	19970613 0330	42 50.0N	009 23.9W	143	repeat of cast 25
27	P100	19970613 0525	42 40.0N	009 12.6W	100	
28	P130	19970613 0725	42 40.0N	009 22.0W	130	
29	P200	19970613 0844	42 40.0N	009 30.0W	194	
30	P1000	19970613 1019	42 39.9N	009 36.4W	981	
31	P1000P	19970613 1223	42 39.8N	009 37.0W		with light meter
32	P2000	19970613 1433	42 40.1N	009 50.9W	1987	
33	P2250	19970613 1708	42 40.0N	010 00.1W	2250	
34						second half of cast 33
35	P2800	19970613 2024	42 40.0N	010 17.9W	2797	renamed from P2900
36	Q2500	19970614 0125	42 29.8N	010 00.8W	2752	
37	Q2200	19970614 0422	42 29.9N	009 50.2W	2220	
38	V3100	19970614 1810	41 25.0N	009 57.0W	3222	
39	V2800	19970614 2135	41 25.0N	009 47.0W	2042	
40	V2600	19970615 0145	41 24.9N	009 39.7W	2600	
41	V2400	19970615 0500	41 24.7N	010 31.0W	2500	
42	V2200	19970615 0658	41 25.0N	009 24.0W	2225	
43	V1150	19970615 0930	41 25.0N	009 16.9W	1498	
44	V160	19970615 1144	41 25.0N	009 11.3W	156	
45	V110	19970615 1303	41 24.9N	009 05.9W	108	
46	V75	19970615 1413	41 24.9N	009 57.9W	77	
47	V55	19970615 1525	41 24.7N	008 52.4W	57	
48	U100	19970615 1838	41 47.8N	009 00.8W	92	
49	U120	19970615 1948	41 47.9N	009 09.0W	117	
50	U1000	19970615 2140	41 47.9N	009 26.0W	1001	

Bottom position listed if available, otherwise start position is listed

RRS Charles Darwin Cruise CD105B CTD Information

51	U2000	19970615 2343	41 47.9N	009 33.1W	2086	
52	U150	19970616 0226	41 47.9N	009 17.2W	152	
53	U2500	19970616 0535	41 47.9N	009 47.9W	2490	
54	U2800	19970616 0903	41 47.9N	010 04.1W	2820	
55	T2500P	19970616 1300	42 00.1N	010 00.5W	2556	
56	T2500	19970616 1404	42 00.2N	010 01.1W	2563	
57	T2100	19970616 1730	42 59.9N	009 50.0W	2114	
58						second half of cast 57
59	T2000	19970616 2011	41 59.9N	009 40.4W	1980	
60	T1600	19970616 2230	41 59.9N	009 32.4W	1666	
61	T200P	19970617 0210	42 00.1N	009 17.3W	164	
62	T1000	19970617 0345	41 59.5N	009 26.9W	1000	
63	T150	19970617 0542	42 00.0N	009 13.8W	145	
64	T100	19970617 0712	42 00.0N	009 00.0W	100	fault - no bottles
65						test
66	S90	19970617 0847	42 09.0N	008 57.4W	92	
67	S130	19970617 0950	42 08.8N	009 02.9W	131	
68	S150	19970617 1054	42 09.0N	009 08.4W	148	
69	S200	19970617 1356	42 08.9N	009 19.6W	222	
70	S600	19970617 1516	42 09.0N	009 26.3W	593	
71	S1000	19970617 1635	42 09.1N	009 28.1W	1057	
72	S2000	19970617 1857	42 08.9N	009 39.8W	1982	
73	R1500	19970617 2243	42 20.1N	009 37.6W	1645	
74	R1000	19970618 0135	42 20.5N	009 29.9W	912	
75	R100	19970618 0852	42 19.9N	009 00.1W	93	
76	R150	19970618 1020	42 19.9N	009 12.0W	154	
77	R200	19970618 1130	42 20.0N	009 17.2W	230	
78	R600	19970618 1343	42 20.8N	009 27.5W	595	all bottles misfired
79	R600	19970618 1502	42 20.6N	009 28.1W	715	repeat of above
80	R2000	19970618 1729	42 20.0N	009 46.9W	1995	
81	S2550	19970618 2059	42 09.0N	010 00.1W	2530	
82	S2250	19970619 0001	42 09.0N	009 44.1W	2250	to 1500m only
83	S600	19970619 0300	42 09.7N	009 26.3W	534	
84	S2600	19970619 0755	42 09.2N	010 18.4W	2765	
85	R2500	19970619 1149	42 19.8N	010 00.1W	2527	
86	Q2000	19970619 1535	42 29.9N	009 39.8W	1982	wire angle implies flow at 500-600m
87	Q1500	19970619 1758	42 29.9N	009 32.5W	1520	
88	Q1000	19970619 2016	42 29.9N	009 26.3W	1026	
89	Q136	19970619 2219	42 30.0N	009 16.7W	136	
90	Q100	19970620 0100	42 29.6N	009 10.5W	100	
91	Q600	19970620 0329	42 30.2N	009 25.7W	620	Belgica Intercalibration (IN1A)
92	P200	19970620 1220	42 40.1N	009 29.3W	194	
93	P500	19970620 1349	42 39.7N	009 32.9W	500	
94	P1000	19970620 1504	42 39.7N	009 36.1W	978	

Bottom position listed if available, otherwise start position is listed

Table 5. CTD temperature calibration against reversing thermometers

CTD STN.	RTM 220	RTM 238	CTD TEMP
1	13.69	13.681	13.673
12	17.629	17.63	17.631
13	13.476	13.477	13.467
17	13.718	13.718	13.715
18	2.757	2.753	2.757
19	2.597	2.593	2.598
22	3.783	3.78	3.782
23	11.394	11.392	11.394
27	17.722	17.724	17.718
29	13.356	13.357	13.343
32	7.425	7.423	7.419
35	2.832	2.829	2.833
37	3.574	3.571	3.575
38	2.713	2.709	2.741
39	4.095	4.093	4.091
41	11.255	11.255	11.253
42	3.916	3.913	3.947
44	13.345	13.345	13.343
48	14.348	14.346	13.348
49	14.389	14.387	14.388
50	11.181	11.179	11.18
53	3.239	3.235	3.237
59	4.053	4.051	4.05
62	11.399	11.398	11.399
63	14.11	14.109	14.109
72	3.851	3.847	3.85
75	13.661	13.668	13.653
83	13.777	13.761	13.729
84	2.87	2.866	2.869
86	4.166	4.164	4.161
88	11.039	11.039	11.027
89	13.78	13.78	13.733
91	11.374	13.373	11.374

Table 6. CTD salinity calibration against bottle samples (with figure)

C.T.D. SALINITIES FOR CRUISE CD105

UNEDITED DATA

C.T.D. SERIAL NUMBER 1195

S = SUSPECT

CTD STATION NUMBER	BOTTLE NUMBER	DATE / TIME	AUTOSAL CORR.	C.T.D. LEVEL B	ERROR LEVEL B	C.T.D. EG+G	ERROR EG+G	LEVEL B MINUS EG+G	CORR. ERRORS LEVEL B	CORR. ERRORS EG+G
CD001	11		35.869	35.845	0.024	35.844	0.025	0.001	-0.001	0.001
CD012	14		35.836	35.817	0.019	35.815	0.021	0.002	-0.006	-0.003
CD013	15		35.868	35.843	0.025	35.841	0.027	0.002	0.000	0.003
CD017	16		35.78	35.758	0.022	35.757	0.023	0.001	-0.003	-0.001
CD018	17		34.938	34.915	0.023	34.919	0.019	-0.004	-0.002	-0.005
CD019	18		34.924	34.896	0.028	34.901	0.023	-0.005	0.003	-0.001
CD022	20		35.013	34.985	0.028	34.988	0.025	-0.003	0.003	0.001
CD023	21		36.052	36.03	0.022	36.03	0.022	0	-0.003	-0.002
CD027	22		35.824	35.804	0.02	35.803	0.021	0.001	-0.005	-0.003
CD029	23		35.944	35.923	0.021	35.923	0.021	0	-0.004	-0.003
CD032	25		35.909	35.888	0.021	35.887	0.022	0.001	-0.004	-0.002
CD035	26		34.948	34.923	0.025	34.926	0.022	-0.003	0.000	-0.002
CD037	27		35.016	34.987	0.029	34.991	0.025	-0.004	0.004	0.001
CD037	28		35.016	34.987	0.029	34.991	0.025	-0.004	0.004	0.001
CD038	30		34.936	34.911	0.025	34.916	0.02	-0.005	0.000	-0.004
CD039	31		35.078	35.044	0.034	35.047	0.031	-0.003	0.009	0.007
CD041	32		36.2	36.175	0.025	36.176	0.024	-0.001	0.000	0.000
CD042	33		36.202	36.176	0.026	36.178	0.024	-0.002	0.001	0.000
CD043	34		35.607	35.593	0.014	35.595	0.012	-0.002	-0.011	-0.012
CD044	36		35.839	35.814	0.025	35.814	0.025	0	0.000	0.001
CD048	37		35.961	35.939	0.022	35.938	0.023	0.001	-0.003	-0.001
CD049	38		35.975	35.954	0.021	35.954	0.021	0	-0.004	-0.003
CD050	39		36.179	36.154	0.025	36.155	0.024	-0.001	0.000	0.000
CD053	40		34.992	34.961	0.031	34.965	0.027	-0.004	0.006	0.003
CD059	42		35.071	35.042	0.029	35.045	0.026	-0.003	0.004	0.002
CD062	43		36.154	36.128	0.026	36.129	0.025	-0.001	0.001	0.002
CD063	44		35.948	35.926	0.022	35.925	0.023	0.001	-0.003	-0.001
CD071	46		35.809	35.784	0.025	35.785	0.024	-0.001	0.000	0.000
CD072	47		35.032	35.003	0.029	35.008	0.024	-0.005	0.004	0.000
CD075	48		35.879	35.856	0.023	35.856	0.023	0	-0.002	-0.001
CD083	49		35.816	35.793	0.023	35.791	0.025	0.002	-0.002	0.001
CD084	50		35.711	35.687	0.024	35.686	0.025	0.001	-0.001	0.001
CD084	51		35.932	35.906	0.026	35.907	0.025	-0.001	0.001	0.001
CD084	52		34.954	34.926	0.028	34.931	0.023	-0.005	0.003	-0.001
CD086	54		35.079	35.048	0.031	35.053	0.026	-0.005	0.006	0.002
CD087	56		35.773	35.73	0.043	35.737	0.036	-0.007	0.018	0.012
CD088	57		36.129	36.1	0.029	36.102	0.027	-0.002	0.004	0.003
CD089	58		35.898	35.872	0.026	35.871	0.027	0.001	0.001	0.003
CD091	59		35.904	35.876	0.028	35.879	0.025	-0.003	0.003	0.001
CD091	60		35.641	35.616	0.025	35.617	0.024	-0.001	0.000	0.000
CD091	61		35.764	35.737	0.027	35.737	0.027	0	0.002	0.003
CD091	62		35.833	35.81	0.023	35.809	0.024	0.001	-0.002	0.000
CD091	63		35.895	35.871	0.024	35.871	0.024	0	-0.001	0.000
CD091	64		35.877	35.871	0.006	35.869	0.008	0.002	-0.019	-0.016
CD091	65		35.918	35.879	0.039	35.875	0.043	0.004	0.014	0.019
CD091	66		35.9	35.876	0.024	35.878	0.022	-0.002	-0.001	-0.002
CD091	67		35.803	35.812	-0.009	35.807	-0.004	0.005	-0.034	-0.028
CD091	68		35.427	35.388	0.039	35.386	0.041	0.002	0.014	0.017
CD091	69		35.291	35.275	0.016	35.272	0.019	0.003	-0.009	-0.005
CD091	70		35.29	35.268	0.022	35.267	0.023	0.001	-0.003	-0.001

TWO SAMPLES TAKEN FROM THE SAME BOTTLE

NO SEALING CAP (S)

BOTTLE NOT SHAKEN (S) NO SEALING CAP

S

S

S

S

S

LEVEL B
AVERAGE
ERROR
0.024875

EG+G
AVERAGE
ERROR
0.0238542

AUTOSAL / LEVEL B AND EG+G SALINITIES

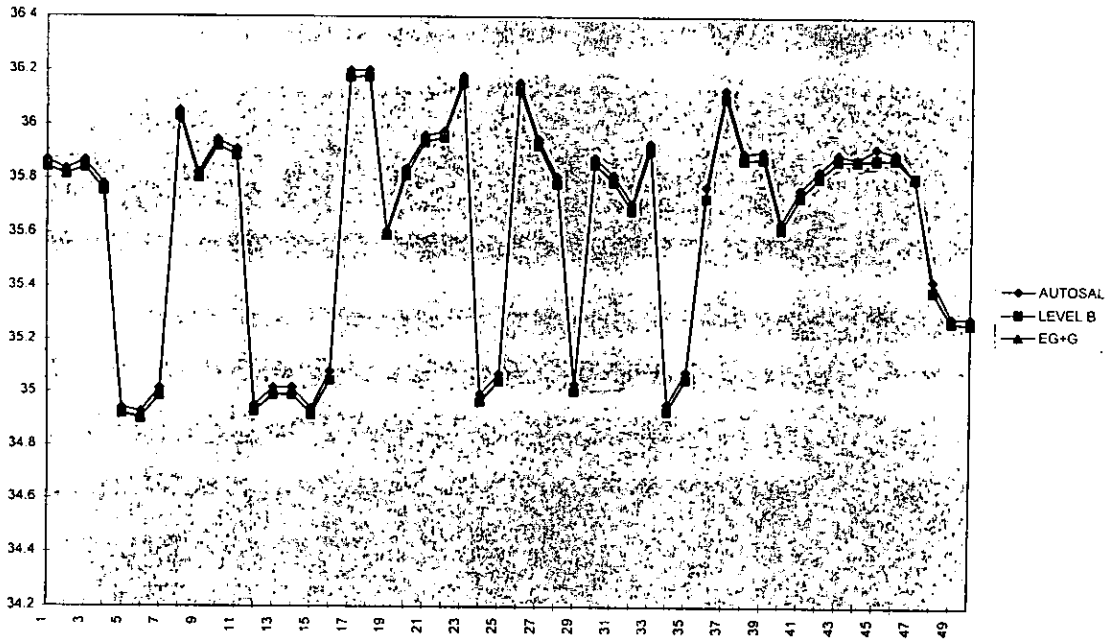

ERRORS LEVEL B, EG+G AND LEVEL B v EG+G

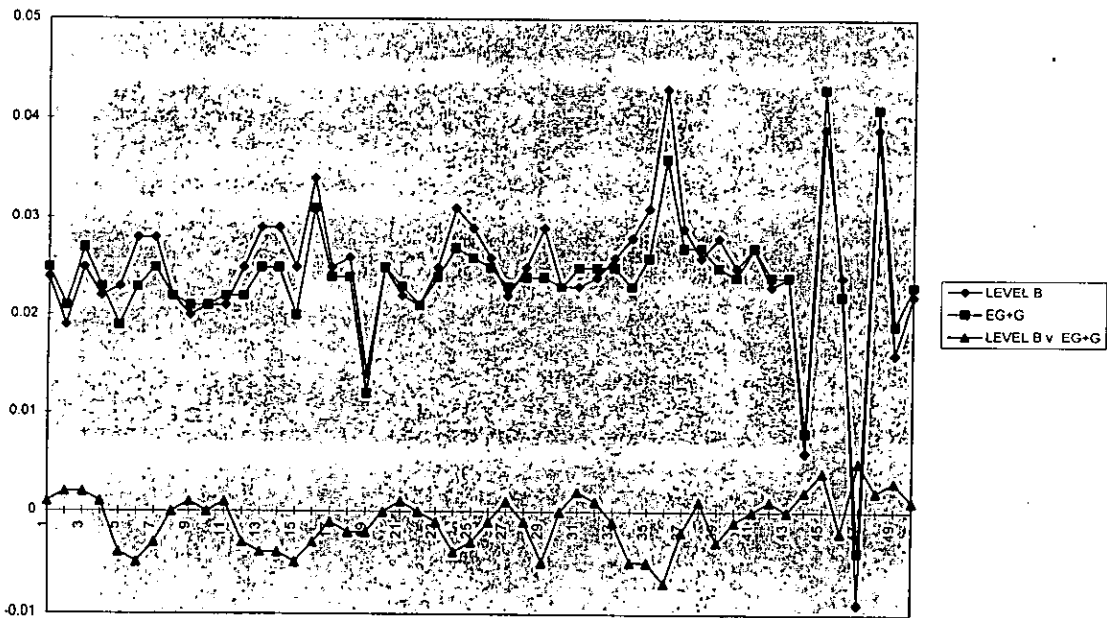

CORRECTED ERRORS LEVEL B & EG+G

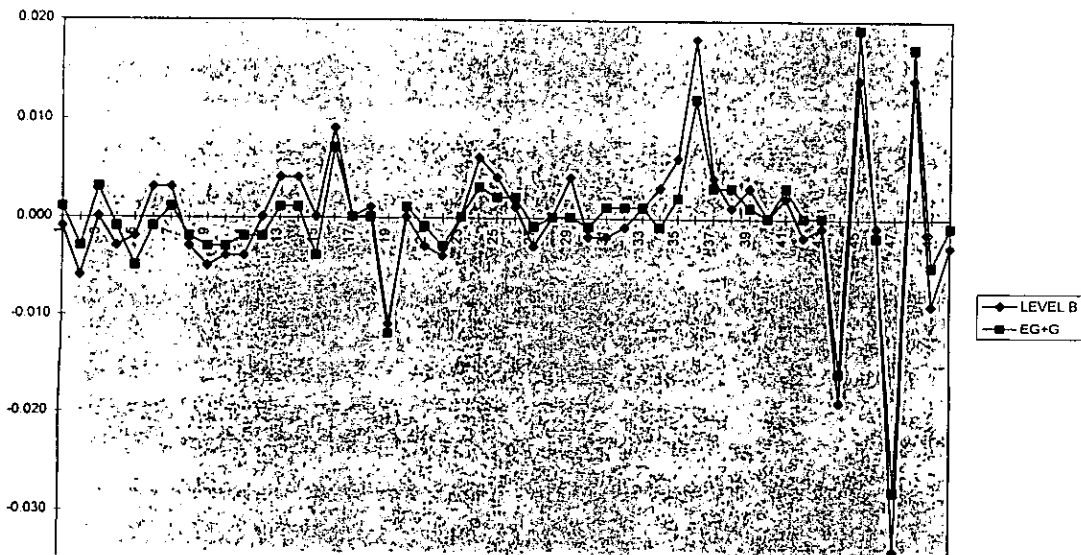

Table 7. Thermosalinograph salinity against water samples (with figure)

T.S.G. SALINITIES FOR CRUISE CD105 UNEDITED DATA
 O.C.M. SER. 1347 O.T.M. SER. 1339

BOTTLE NUMBER	DATE/ TIME	CORR. AUTOSAL	T.S.G. LEVEL B	ERROR LEVEL B	CORR. LEVEL B
1	150 /09.53	35.775	35.799	-0.024	0.051
2	151/ 11.03	35.73	35.77	-0.040	0.035
3	152/ 11.20	35.81	35.821	-0.011	0.064
4	153/ 11.10	35.871	35.908	-0.037	0.038
5	154/ 11.15	35.862	35.951	-0.089	-0.014
6	155/ 11.23	35.768	35.862	-0.094	-0.019
7	156/ 11.16	35.834	35.934	-0.100	-0.025
8	157/ 11.09	35.825	35.922	-0.097	-0.022
9	158/ 11.19	35.888	35.986	-0.098	-0.023
10	159/ 11.04	35.835	35.919	-0.084	-0.009
12	161/ 16.25	35.834	35.919	-0.085	-0.010
13	162/ 13.29	35.777	35.86	-0.083	-0.008
19	163/ 12.04	35.817	35.9	-0.083	-0.008
24	164/ 16.00	35.892	35.977	-0.085	-0.010
29	165/ 12.45	35.852	35.941	-0.089	-0.014
35	166/ 11.35	35.911	35.997	-0.086	-0.011
41	167/ 13.53	35.936	36.023	-0.087	-0.012
45	168/ 13.50	35.881	35.956	-0.075	0.000
53	170/ 13.02	35.834	35.915	-0.081	-0.006
55	170/ 19.10	35.242	35.322	-0.080	-0.005
71	171/ 15.34	35.55	35.62	-0.070	0.005

HOUSING WRONG
WAY ROUND

HOUSING CORRECT
WAY ROUND

LEVEL B
AVERAGE
ERROR
-0.075

ERROR LEVEL B

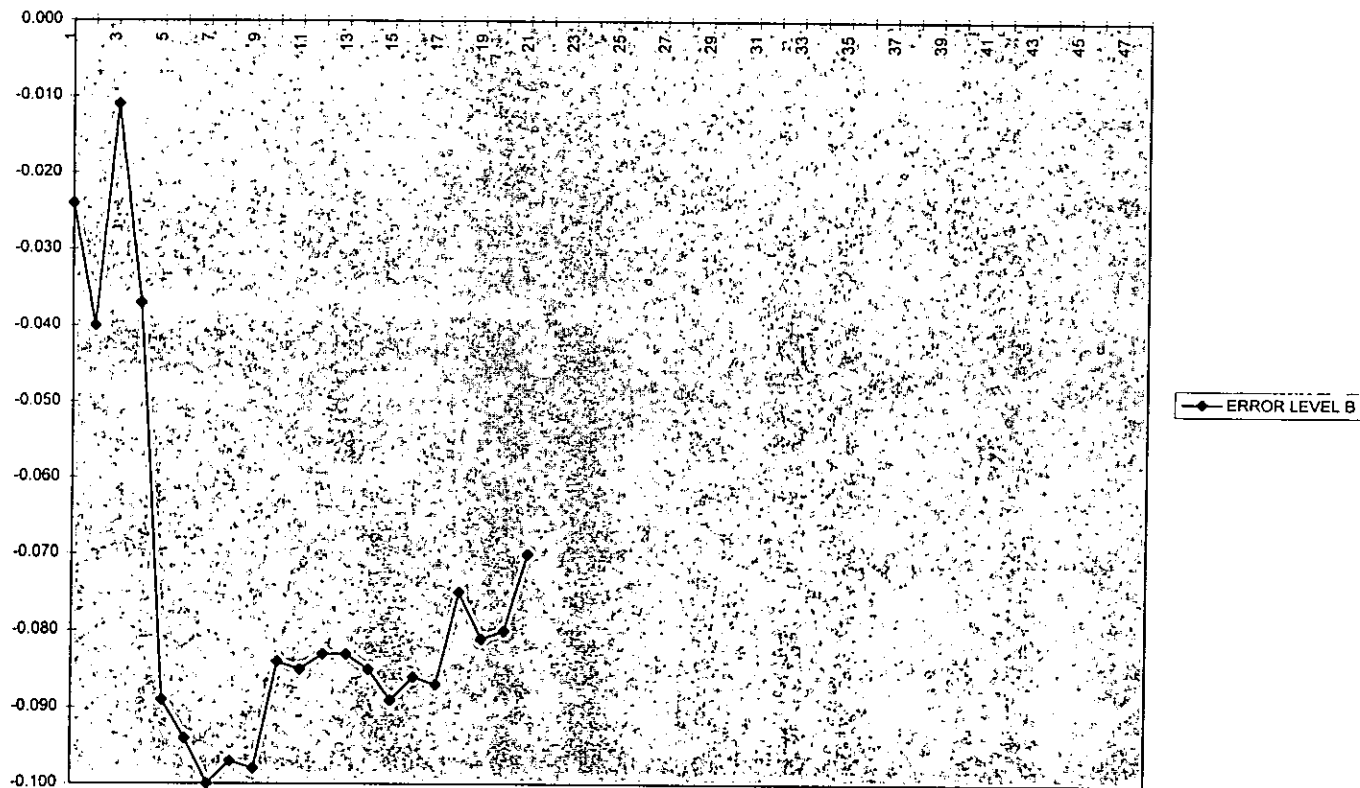

TSG SALINITIES

CORRECTED ERRORS

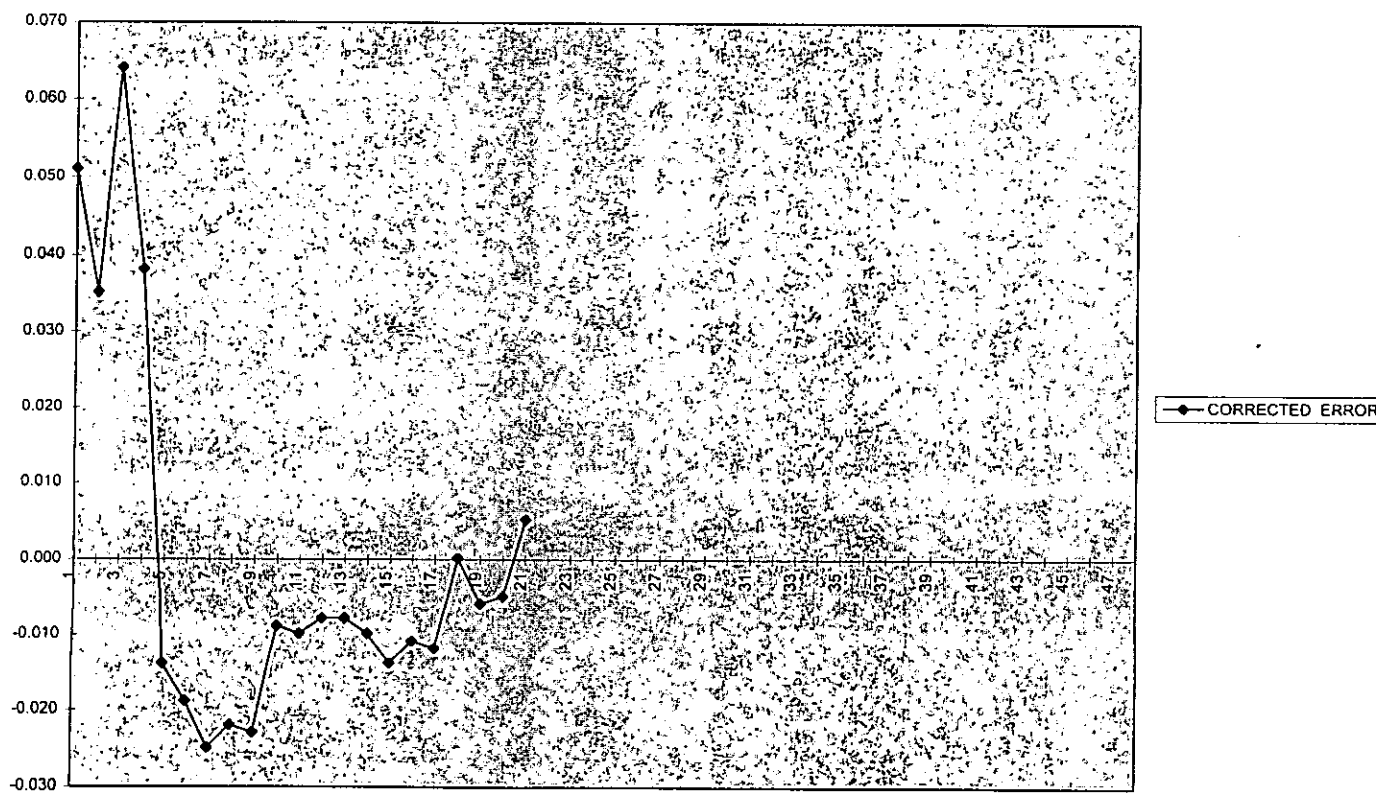
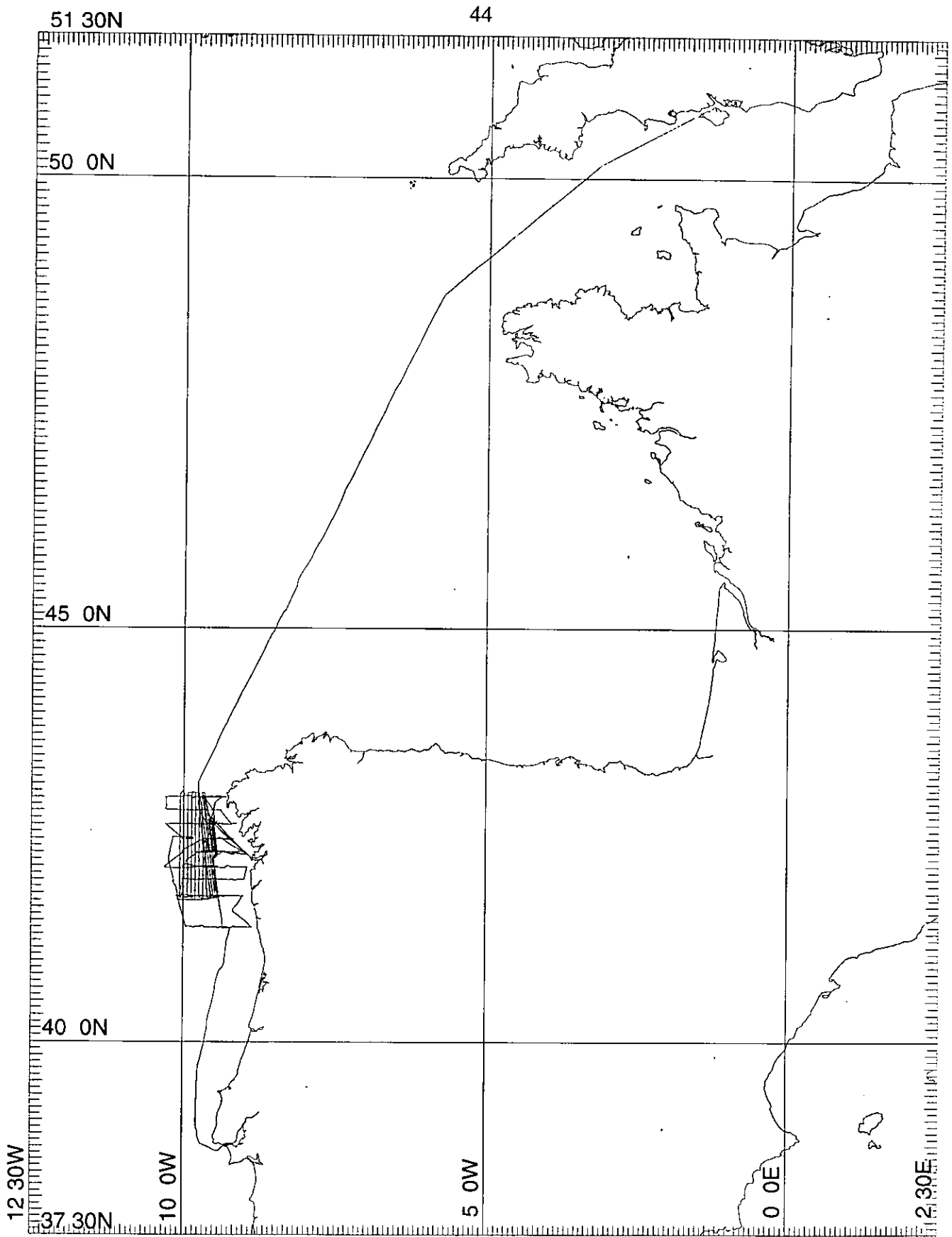

Table 8. Sampling for pigments, biogenic calcite and silicate, microzooplankton

Date	Time	Cast	Station	Pigment depths	Calcite and Silicate depths	Microzooplankton depths	Epifluorescence, fixed	Epifluorescence, slides
10/06/97	14:25	1	P1000	4,24,34,44,66,98,115,195	-	-	-	-
10/06/97	23:03	6	N30	10,20,30	10,20,30	10,20,30	-	-
11/06/97	16:24	12	N100	10,20,31,40,50,70,110	-	10,20,31,40,50,70,110	-	-
11/06/97	19:20	14	N1600	21,30,40,50,70,100,120,201	-	21,30,40,50,70,100,120,201	-	-
11/06/97	21:30	15	N2300	10,30,50,70,101,200	10,30,50,70,101,200	10,30,50,70,101	-	-
12/06/97	03:30	17	N2000	PP: 5,10,15,20,25,35,45,60,100	-	-	-	-
12/06/97	08:30	19	N3300	M: 10,20,31,40,50,100,200	-	-	-	-
12/06/97	11:50	20	N3300	70	-	70	70	70
12/06/97	16:00	21	Q2650	10,20,30,40,51,100,120,200	-	10,20,30,51,70,100	10,20,30,51,70,100	10,20,30,51,70,100
13/06/97	03:30	25	Q140	PP: 5,10,20,30,40,50,100	-	-	-	-
13/06/97	05:25	27	P100	10,20,30,40,50,70	-	-	-	-
13/06/97	08:44	29	P200	10,20,30,40,50,100,120,178	-	-	-	-
13/06/97	10:05	30	P1000	M: 10,20,30,50,70,100,120,200	-	-	-	-
13/06/97	14:30	32	P2000	10,20,30,40,50,70,100,120,200	-	10,20,30,50,70,100	10,20,30,50,70,100	10,20,30,50,70,100
14/06/97	04:22	36	Q2500	PP: 5,10,15,20,25,35,45,60,100	-	-	-	-
14/06/97	18:10	38	V3100	10,20,30,40,50,70,100,120,200	-	10,20,30,40,50,70,100	-	-
15/06/97	01:45	40	V2600	PP: 5,10,20,30,45,60,80,120	-	-	-	-
15/06/97	09:25	43	V1150	10,20,30,40,50,70,100,200	-	10,20,30,40,50,70,100	10,20,30,40,50,70,100	-
15/06/97	11:44	44	V160	M: 10,20,30,40,50,70,120,146	-	10,20,30,50,70	10,20,30,50,70	-
15/06/97	15:20	47	V55	4,10,20,30,40,50	-	4,10,20,30,40,50	4,10,20,30,40,50	-
15/06/97	19:48	49	U120(150)	10,20,30,40,50,70,100,118	10,20,30,40,50,70,100,118	-	-	-
16/06/97	02:26	52	U150(200)	PP: 5,10,15,20,25,35,45,60,100	-	-	-	-
16/06/97	13:00	55	T2500	M: 10,20,30,40,50,70,100,120,200,300	-	-	-	-
17/06/97	02:30	61	T200	PP: 5,10,15,20,25,35,45,60,100	-	-	-	-
17/06/97	09:50	67	S130	10,20,40,50,70,100	-	10,20,30,40,50,70,100	10,20,30,40,50,70,100	-
17/06/97	13:59	69	S200	10,20,30,40,50,70,80,100,120,200	-	-	-	-
17/06/97	15:10	70	S600	10,20,30,40,50,70,100,197	-	-	-	-
17/06/97	16:35	71	S1000	5,10,20,30,40,70,100,120	-	-	-	-
17/06/97	18:57	72	S2000	10,20,30,40,50,70,100,120,200	-	-	-	-
18/06/97	01:35	74	R1000	PP: 5,10,25,30,40,50,100	-	-	-	-
18/06/97	08:52	75	R100	5,10,20,30,40,50,70,87	-	-	-	-
18/06/97	11:30	77	R200	M: 10,20,30,40,50,70,100,120,200,226	-	-	-	-
19/06/97	15:16	70	S600	PP: 5,10,15,20,35,45,60,100	-	-	-	-
19/06/97	17:32	80	R2000	10,20,30,50,70,100,120,200	-	-	-	-
19/06/97	07:55	84	S2600	5,10,20,30,40,50,70,100,120,200	-	5,10,20,30,40,50,70,100	10,30,70	-
19/06/97	15:35	86	Q2000	10,20,30,40,50,70,100,119,200	10,20,30,40,50,70,100,119,200	-	-	-
19/06/97	20:05	88	Q1000	10,20,30,40,50,70,100,120,200	-	-	-	-
20/06/97	01:00	90	Q100	PP: 5,10,15,20,25,30,40,87	-	-	-	-
20/06/97	03:30	91	Q600	IC: 5,10,20,40,60,80,100,150,200,400	-	-	-	-
20/06/97			Belgica	IC: 20,30,40	-	-	-	-
20/06/97	12:15	92	P200rtn	10,20,40,50,70,120,167	-	-	-	-
PP=Primary production								
M=Midday								
IC=Intercalibration								
Underway samples (20) were also taken throughout the cruise and filtered for pigments, calcite and silicate.								
Underway pigments were occasionally (6) obtained in triplicate for a reproducibility study.								



MERCATOR PROJECTION

GRID NO. 1

SCALE 1 TO 7000000 (NATURAL SCALE AT LAT. 45)

INTERNATIONAL SPHEROID PROJECTED AT LATITUDE 42

Charles Darwin 105 OMEX May/June 1997

Figure 1

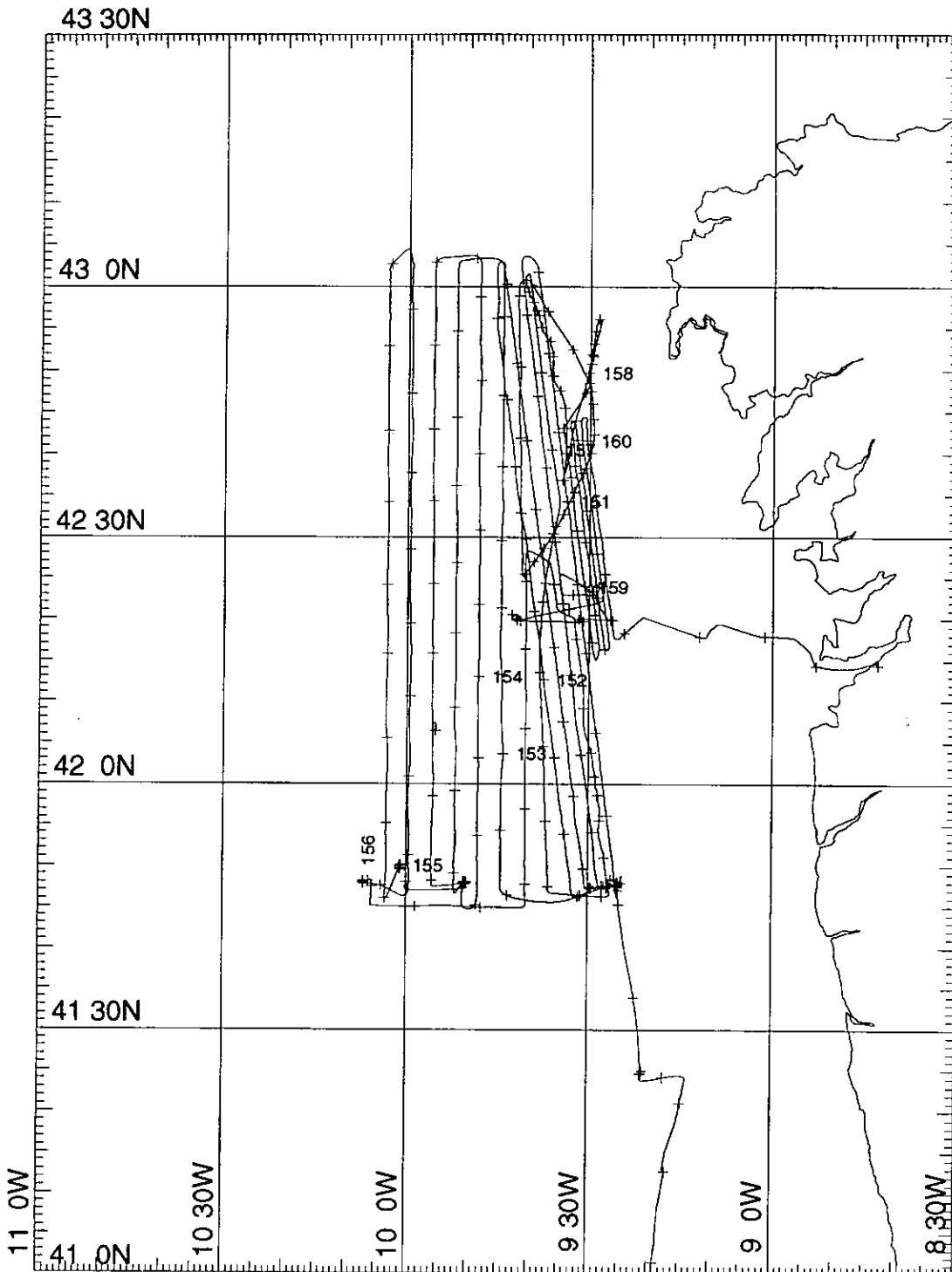

MERCATOR PROJECTION

SCALE 1 TO 1500000 (NATURAL SCALE AT LAT. 42)

INTERNATIONAL SPHEROID PROJECTED AT LATITUDE 42

GRID NO. 1

Charles Darwin 105 Leg A

Figure 2

+

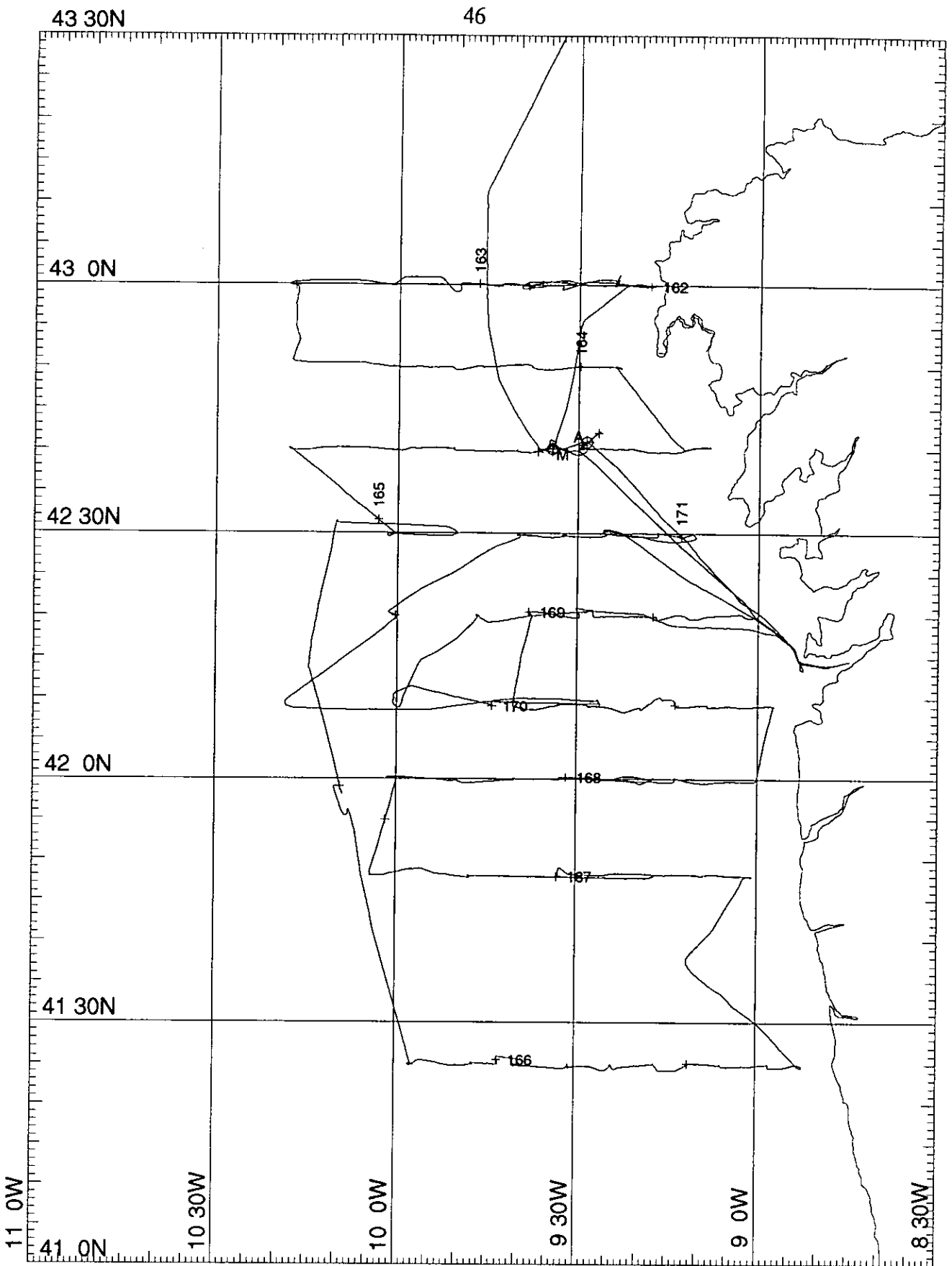

MERCATOR PROJECTION

GRID NO. 1

SCALE 1 TO 1250000 (NATURAL SCALE AT LAT. 42)

INTERNATIONAL SPHEROID PROJECTED AT LATITUDE 42

Charles Darwin 105 Leg B June 1997

Figure 3

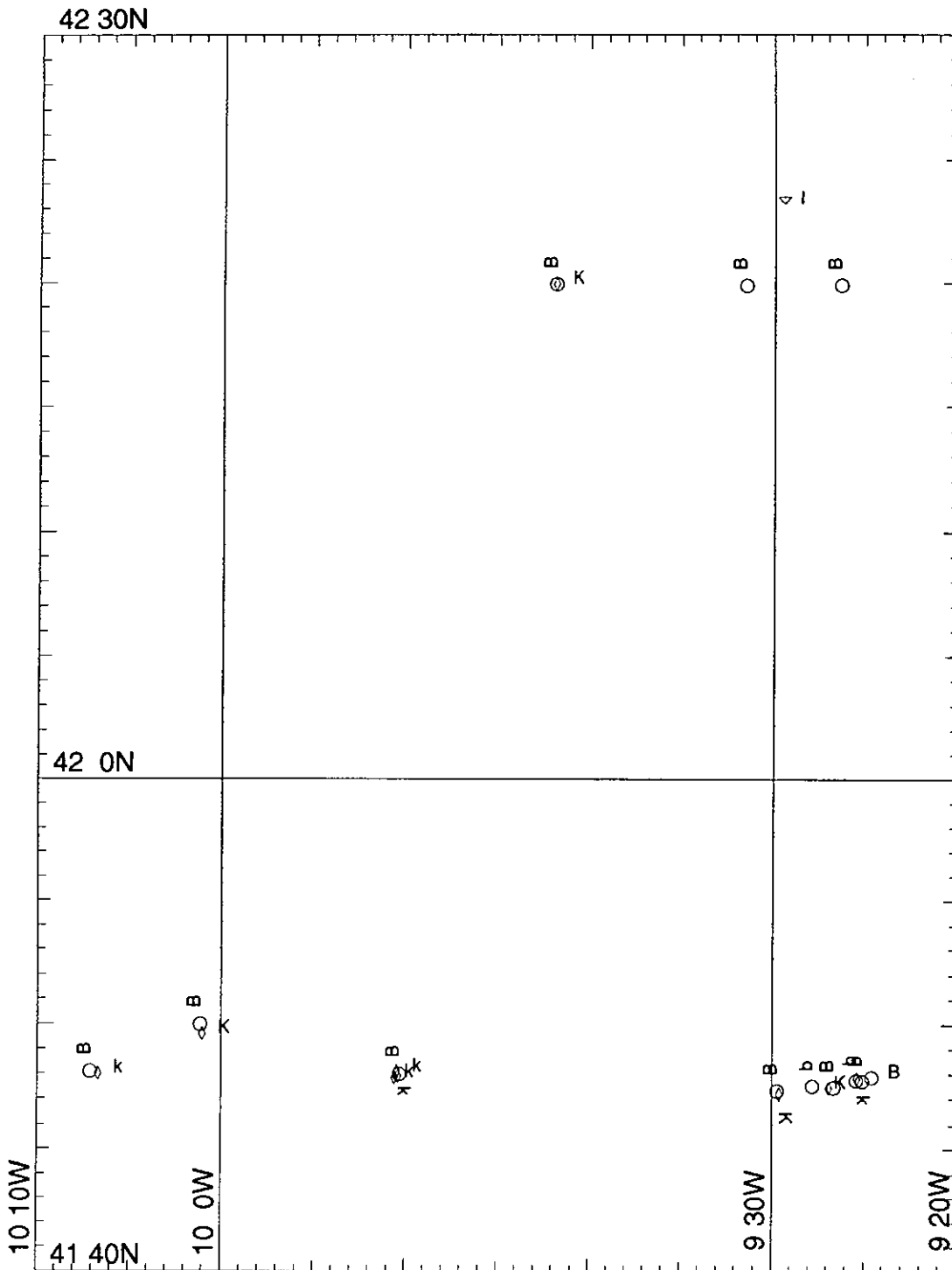

MERCATOR PROJECTION

SCALE 1 TO 500000 (NATURAL SCALE AT LAT. 42)

INTERNATIONAL SPHEROID PROJECTED AT LATITUDE 42

GRID NO. 1

Figure 4 Coring locations and IES position

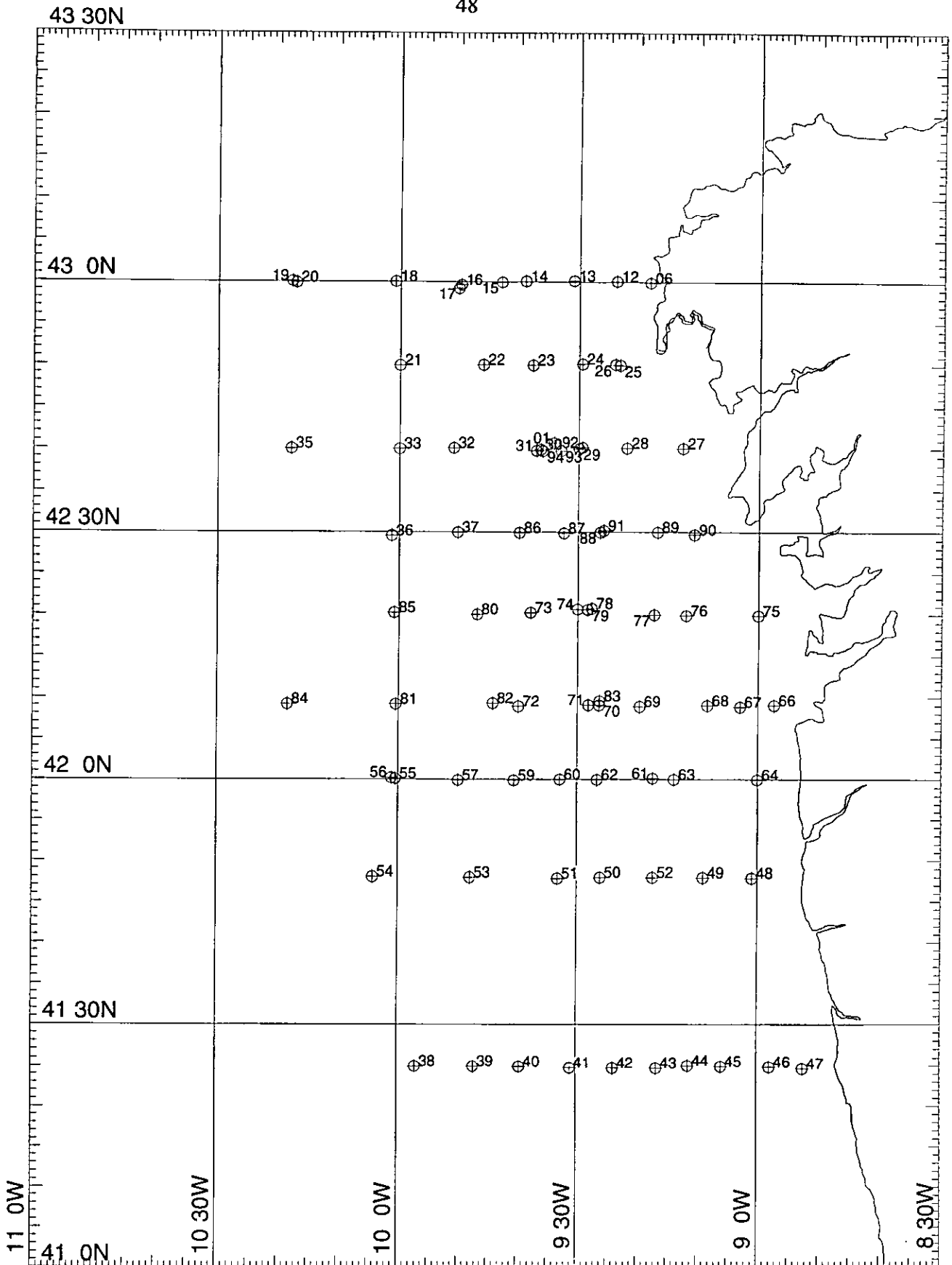

MERCATOR PROJECTION

GRID NO. 1

SCALE 1 TO 1250000 (NATURAL SCALE AT LAT. 42)

INTERNATIONAL SPHEROID PROJECTED AT LATITUDE 42

Figure 5 Charles Darwin 105 Leg B CTD Stations