

*F.S. POSEIDON*

**CRUISE 328**

**TORSHAVN**

**to**

**ABERDEEN**

**6 SEPTEMBER 2005**

**to**

**25 SEPTEMBER 2005**

**Dr. J.M. HUTHNANCE**

**SLOPE MIXING**

**CRUISE REPORT NO. 48**

**2005**

**POL CRUISE REPORT NUMBER 48**

**F.S. POSEIDON CRUISE 328**

**SLOPE MIXING**

**Torshavn to Aberdeen**

**Principal Scientist: Dr. J.M. Huthnance**

## DOCUMENT DATA SHEET

AUTHOR HUTHNANCE, J.M.	PUBLICATION DATE 2005
TITLE Cruise Report <i>POSEIDON</i> 328, 6-25 September 2005. Slope Mixing.	
REFERENCE Proudman Oceanographic Laboratory, Cruise Report No. 48	
<p>ABSTRACT</p> <p><i>Poseidon</i> cruise 328 aimed to make measurements of internal waves on the West Shetland slope, and their induced mixing and bottom boundary layer forms over the slope. This is to be a basis for relating the mixing to the internal waves and the context: slope, stratification, mean flow, interpreting the measurements and using internal-wave and turbulence models.</p> <p>STABLE, HOMER (with ADCP) and the NIOZ lander with ADCP and fast-sampling thermistor string, were deployed for complementary measurements of fine scales in time and space. An ADCP mooring, and three ADCP landers each with a nearby mini-logger mooring, were deployed at the vertices of a quadrilateral centred on the fine-scale instruments. These moorings aimed to determine the local internal wave field, being within the main thermocline between warm Atlantic water above and cold overflow water beneath. CTD/LADCP sections across the West Shetland slope and Faroe Bank Channel were carried out to define the hydrographic context: near 3-4°W, 4.5-5°W, 5.5-6°W. A 25-hour station was carried out at 60° 15.65'N, 4° 42'W in ~ 690 m water depth around neap tides, but weather conditions did not allow this at spring tides. A following 13-hour repeated section was carried out between 60° 15.65'N, 4° 42'W and 60° 7'N, 4° 28'W (~190 m water depth) running the ship-mounted ADCP. This repeat station and section aimed to separate out tidal structure. All moorings were recovered except for the ADCP mooring and STABLE [which were subsequently recovered by <i>Pelagia</i>]. Most of the data appear to be of good quality with the exceptions of HOMER microstructure (sensors and shear data lost during recovery) and NIOZ fast-sampling thermistor string (only 3 hours recorded). Nearly 10½ of the 20 planned days were lost to bad weather.</p> <p>ACKNOWLEDGEMENT. The scientific party extends warm thanks to the Master, Michael Schneider, officers and crew of <i>Poseidon</i>, for their help and co-operation during the cruise, and to UKORS and IfM-Geomar, especially Thomas Müller, for their support, all willingly given and making the scientific work possible.</p>	
ISSUING ORGANISATION <b>Proudman Oceanographic Laboratory</b> <b>Joseph Proudman Building</b> <b>6, Brownlow Street</b> <b>Liverpool</b> <b>Merseyside</b> <b>L3 5DA</b> <b>UK</b>  <b>Director: Prof. A.J. Willmott</b>	TELEPHONE: <b>(0151) 795 4800</b>  FAX: <b>(0151) 795 4801</b>  TELEX:
KEYWORDS NE ATLANTIC FAROE- SHETLAND CHANNEL CONTINENTAL SLOPE HYDROGRAPHY MOORINGS INTERNAL WAVES SLOPE MIXING	CONTRACT PROJECT LLP 42

<b>CONTENTS</b>		<b>Page No.</b>
1.	OBJECTIVES	5
2.	SUMMARY	6
3.	PERSONNEL ON BOARD	7
4.	NARRATIVE	8
5.	TECHNICAL REPORTS	
5.1	ADCP moorings	10
5.2	Temperature-logger moorings	18
5.3	STABLE	25
5.4	HOMER with ADCP	28
5.5	NIOZ ADCP/thermistor-string bottom-lander	29
5.6	CTD	31
5.7	Lowered ADCP	32
5.8	Vessel-mounted ADCP	34
5.9	Satellite images	35
5.10	Underway surface and meteorological measurements	36
5.11	PES and bathymetry	36
5.12	Computing and other ship systems	37
5.13	References	37
6.	CONCLUSIONS	38
TABLES		
1	Moorings	39
2	CTD/LADCP stations	40
FIGURES		
1	Track plot	42
2	Mooring locations	43
3	CTD locations	44



## 1. OBJECTIVES

Overall objectives in the POL science programme to 2007 include estimates of slope mixing and some of its oceanic effects. As part of this, objectives on the cruise were to make measurements to enable estimates of internal waves and their induced mixing and bottom boundary layer forms (over the West Shetland slope), and to enable the estimates to be related to context: stratification, slope, mean flow. [In the wider project, further allied objectives are: to derive, using 3-D fine-resolution and specialist process models for extrapolation, estimated effects on the characteristics of water flowing adjacent to slopes with (internal-wave-induced) mixing; to estimate, using 3-D fine-resolution models for extrapolation, the role slope mixing and associated processes such as water mass transformation, play in cross-slope exchange of mass, heat, salt and nutrients].

*Specific objectives for F.S. Poseidon cruise 328 were:*

1.1 Deploy ADCP moorings at the points of a cross centred on 500m depth near 4° 36'W, 60° 18'N, one axis aligned along the 500m depth contour and spanning ~ 6.6 km, the other axis normal to this and spanning the range between 450m and 550m water depths.

1.2 Deploy temperature-logger moorings close to the ADCP moorings at the SW, SE and NE points.

1.3 Deploy the specialist rigs STABLE, HOMER and NIOZ Lander and fast-sampling thermistor string, in a line at the centre of the cross along the 500m depth contour.

1.4 CTD (+LADCP) stations with all mooring deployments.

1.5 Recover all moorings at the end of the cruise.

1.6 CTD (+LADCP) surveys of cross-slope sections, spanning the range between 200m and 1000m water depths, station separations being the lesser of (5 km, depth-contour spacing for 100m depth increments), centred on the mooring array and at 3°-3.4°W, 5.5°-5.7°W approximately.

1.7 Repeat (24-hr) CTD (+LADCP) stations near neap and spring tides to help estimate the internal wave spectrum and mixing scales.

1.8 Record vessel-mounted ADCP to help identify internal waves in upper waters. Also repeat (24-hr) sections across the slope (200m to 800m) near neap and spring tides to help separate the tidal currents.

1.9 Sequences of CTD (+LADCP) stations following any identified internal wave packets to estimate internal wave decay. Also a section along the 700 m depth contour between the east and west sections.

1.10 Obtain satellite images to show the context for the detailed measurements, especially meanders in the slope current.

1.11 Underway surface and meteorological measurements as further context information.

## 2. SUMMARY

STABLE, HOMER (with ADCP) and the NIOZ lander (with ADCP and fast-sampling thermistor string) were deployed for complementary measurements of fine scales in time and space. An ADCP mooring, and three ADCP landers each with a nearby mini-logger mooring, were deployed at the vertices of a quadrilateral centred on the fine-scale instruments. These moorings aimed to determine the local internal wave field, being within the main thermocline between warm Atlantic water above and cold overflow water beneath. CTD/LADCP sections across the West Shetland slope and Faroe Bank Channel were carried out to define the hydrographic context: near 3-4°W, 4.5-5°W, 5.5-6°W. A 25-hour repeat station was carried out at 60° 15.65'N, 4° 42'W in ~ 690 m water depth around neap tides, but weather conditions did not allow this at spring tides. A following 13-hour repeated section was carried out between 60° 15.65'N, 4° 42'W and 60° 7'N, 4° 28'W (~190 m water depth) running the ship-mounted ADCP. This repeat station and section aimed to separate out tidal structure. All moorings were recovered except for STABLE and the ADCP mooring for which subsequent recovery possibilities were pursued. Most of the data appear to be of good quality with the exceptions of HOMER microstructure (sensors and shear data lost during recovery) and NIOZ fast-sampling thermistor string (only 3 hours record, uncalibrated). Nearly 10½ of the 20 planned days were lost to bad weather.

Thus the cruise objectives (1.1 to 1.11) were generally met with the following exceptions:

- the mooring array (1.1) was centred on 600 m rather than 500 m water depth as a result of the density profiles found just prior to the deployments
- the deepest ADCP and STABLE were not recovered (1.5) owing to bad weather (they were later recovered by *Pelagia*); HOMER's yo-yo capsule with the micro-structure data were lost during recovery
- only one repeat (24-hr) CTD+LADCP station was carried out (1.7), near neap tides
- there was only one repeat (13-hr) section across the slope (200m to 700m), near neap tides
- no sequences of CTD (+LADCP) stations tracked internal wave packets (1.9); weather allowed only a short east-west section along the 700 m depth contour (preferred as a means of observing propagating wave forms).

Good context and array data were obtained towards the overall scientific objectives. However, there were losses from the most novel measurements of microstructure for mixing estimates.

Initial looks at the data show several interesting features:

unusual and varying distributions of temperature across and along the Faroe-Shetland Channel; strong tidal currents below the main thermocline; rising bands of shear in repeat current profiles; many cases when near-bed temperature and velocity show sharp changes and packets of solitons (of elevation propagating up-slope with quasi semi-diurnal frequency over a period of 4 days).

### 3. PERSONNEL ON BOARD

#### Scientists:

John Huthnance	Proudman Oceanographic Laboratory (POL)	Principal Scientist
Mike Burke	POL	Moorings
John Kenny	POL	Moorings
Mike Smithson	POL	POL instruments
Neil Upton	BODC	Data management
Hans van Haren	Nederlands Instituut voor Onderzoek der Zee (NIOZ)	NIOZ lander
Mark Inall	Scottish Association for Marine Science (SAMS)	HOMER, ADCPs
Clare O'Neill	University of Plymouth (UoP)	Student
Christopher Smarz	Institut für Meereskunde / Geomar (IfM-Geomar)	CTD, ship computing
John Wynar	UK Ocean Research Services (UKORS)	Moorings

#### Officers and Crew:

Michael Schneider	Master
Theo Griese	1 <sup>st</sup> Officer
Ralf Schmidt	2 <sup>nd</sup> Officer
Frank Werner	1 <sup>st</sup> Engineer
Jörg Schweder	2 <sup>nd</sup> Engineer
Werner Dietmar Klare	Electrician
Rüdiger Engel	Motor Engineer
Hans Albert	Cook
Bernd Gerischewski	Steward
Frank Schrage	Bo'sun
Pedro Manuel Barbosa	Seaman
Jürgen Sauer	Ship's mechanic
Thomas Radisch	Ship's mechanic
Jens Hansen	Cadet
Kristen Fischer	Trainee Ship's mechanic



#### 4. NARRATIVE (times in GMT)

*F.S. Poseidon* cast off from Torshavn at 0740 (0840 local time) on 6<sup>th</sup> September 2005 and made course for the working area on a bearing of 150° in still conditions with a slight swell. At 0920 a safety briefing for the scientific party was given by the 2<sup>nd</sup> Officer. Surface monitoring and the vessel-mounted ADCP were switched on. At 1900 the CTD/LADCP station at 900 m depth on the central section was reached and carried out as a demonstration for the guest scientists. This showed the temperature stratification unusually deep at 500-800 m, suggesting that the mooring array might better be moved down-slope by 50-100 m depth. Unfortunately the LADCP failed to record. Passage was made to 800 m depth for wire tests of releases. Two fired, one failed so a spare was tested, successfully. Meanwhile the vessel-mounted ADCP was re-started to enable bottom-tracking.

7<sup>th</sup> September began with a CTD station at the intended STABLE position in 500 m. However, this proved to be above the main temperature stratification and *F.S. Poseidon* proceeded to 600 m on the section for another CTD. Strong stratification was seen near the bottom here, again below 500 m. It was therefore decided to deploy the array centred on 600 m rather than 500 m water depth. STABLE was deployed, then HOMER after another CTD. Both STABLE (SM01Cs) and HOMER (SM02Ch) were deployed using the extending side-arm and winch on the port side of *F.S. Poseidon*. Then the NIOZ lander was deployed (SM03Ch), buoy and thermistor chain streamed out first, from the stern A frame after a CTD. Moving to the western position on the (now) 600 m central line of moorings, a CTD was taken; a POL 150kHz ADCP on a bottom frame was deployed (SM04Wc) using *F.S. Poseidon*'s stern A frame. A minilogger string was also deployed nearby (SM05Wt), by streaming out from the stern and finally lifting the anchor clump overboard (after going about to regain position). Moving to the deepest ADCP mooring position, a CTD was taken followed by deployment of the buoyed ADCP and anchor clump (SM06Nc). All the deployments were carried out in moderate conditions and light winds. Three more CTD stations were taken along the section towards the shallow SE end. The day ended with *F.S. Poseidon* steaming a square at 6 knots for 15 minutes a side to calibrate the vessel-mounted ADCP alignment.

8<sup>th</sup> September began with a CTD station at the "east" ADCP position in 600 m, followed by deployment of the UKORS bottom-framed ADCP itself (SM07Ec) and a minilogger string (SM08Et) over the stern. The sequence was repeated at the "south" position: CTD, POL bottom-mounted ADCP (SM09Sc) and a minilogger string (SM10St) to complete the deployments. This was fortunate as the seas and winds (from ~290°, force 5-7) increased during the morning. *F.S. Poseidon* then made to the shallow SE end of the section aiming to work a complete section to the Faroes shelf. CTD profiles at 200, 300 and 400 m had been completed before increasing swell caused a suspension of work at 1440. The section was resumed at the 500 m CTD station at 1710, conditions having eased slightly.

Conditions continued to ease slowly as the section was continued into 9<sup>th</sup> September. Altogether this section comprised casts 13 to 37 at intervals ~ 5 km (usually less than 100 m water-depth change). A fault prevented bottle samples being taken from cast 22 until the bottle-firing unit was replaced in time for cast 30 (1317). The vessel-mounted ADCP data were backed up at 2015-2028. The section was finished at 2213 in conditions of very light winds and moderate swell. Course was made to 60.5°N, 6°W.

On 10<sup>th</sup> September a section further west across the Faroe-Shetland Channel was worked towards the south-east at intervals ~ 4 km starting with 60.5°N, 6°W at 0121. Winds picked up from the south-east but conditions remained good as the swell subsided; shorter waves from the south-east gradually increased through the day. A muster and boat drill were held at 1430-1500 between stations.

The western section was completed at 0210 on 11<sup>th</sup> September. Conditions remained reasonable with winds force 5-7 veering to southerly and south-westerly, as did the wave direction. The vessel-mounted ADCP was stopped and re-started while course was made to 60° 15.65'N, 4° 42.4'W. Here, a 24-hour CTD/LADCP station started with cast 58 at 0546. Subsequent casts aimed to start on the hour (0700, 0800, etc.). Conditions remained reasonable through the day as the wind and waves veered to westerly; the waves became higher in the evening but eased overnight to westerly swell.

The 24-hour station was completed at 0637 on 12<sup>th</sup> September. The vessel-mounted ADCP was stopped and re-started. A repeat section between 60° 15.65'N, 4° 42.4'W and 60° 7.0'N, 4° 28.0'W (nominally 700 m, 200 m depth respectively) began at 0713. This aimed for vessel-mounted ADCP coverage across the slope in repeated passes to complement the repeat station, both at neap tides. In moderate southerly winds the westerly swell slowly subsided; waves from the south slowly increased; conditions were moderate during the day but worsened in the evening. The repeat section was curtailed at 2155 after four return passes and a fifth single pass to the SE. The wind had reached 33 knots; *F.S. Poseidon* made for shelter off Scotland.

13<sup>th</sup> September was spent making for shelter, via Pentland Firth to a position off Wick (1500). Gale-force winds continued on 14<sup>th</sup>, veering to NW around the storm “Maria” which passed from south of Iceland to northern Norway. Eventually at 0300 on 15<sup>th</sup> September *F.S. Poseidon* was able to start heading for the eastern section via Pentland Firth. The section was commenced in ~ 200 m at 60° 32'N, 3°W at 2030, the wind being moderate but swell still troublesome.

On 16<sup>th</sup> September this eastern section continued; moderate to strong winds from the north backed to north-westerly, nearly died away and picked up again from the west in the afternoon; substantial swell from the north subsided only slowly. For stations in 1100 m or more, the LADCP (1000m depth limit) was removed to enable near-bed measurements. The section, to mid-channel in the Faroe-Shetland Channel at 60° 59.5'N, 4° 12'W, was completed at 1713. Then *F.S. Poseidon* headed for 60° 52.2'N, 3° 20'W, the north-eastern end of a section along the 700 m contour. With the LADCP re-fitted and a new file for the vessel-mounted ADCP record, the section was started at 2013.

In the early morning of 17<sup>th</sup> September winds from the south-west increased rapidly and reached 40 knots; the section had to be suspended at 60° 43.2'N, 3° 45'W (0429) after a bad roll. After initially heading SW into the wind, *F.S. Poseidon* turned SE (0730) for shelter east of Orkney and then Wick. Improving prospects on 18<sup>th</sup> September encouraged course to be set (0630) for Pentland Firth where boils on the flood tide were evident, but an updated forecast of force 9 winds caused a retreat (0930) ending off Wick again. Forecasts on 19<sup>th</sup> September showed that the best (not good) prospects to recover moorings were on 20<sup>th</sup>, and then not until late on 24<sup>th</sup> September. Course was set (1500) via Pentland Firth and the “east” moorings location was reached at 0630 on 20<sup>th</sup>. However, the waves were too high to allow

any work. Forecasts offered some hope of improvement for the 21<sup>st</sup> so *F.S. Poseidon* stayed in the area of the moorings.

On 21<sup>st</sup> September the significant wave height remained at about 3 m, mostly lengthening swell as winds were moderate. Mooring recoveries commenced, in turn: the “east” ADCP (SM07Ec) from 0626 to 0644; the “east” mini-logger string (SM08Et) from 0648 to 0701; the “west” ADCP (SM04Wc) from 0752 to 0809; the “west” mini-logger string (SM05Wt) from 0821 to 0841; HOMER (SM02Ch) from 0922 to 0955; the NIOZ (SM03Cn) thermistor chain (1049-1128) and lander (-1140); the “south” ADCP (SM09Sc) from 1214 to 1230; the “south” mini-logger string (SM10St) from 1238 to 1256. [Here times given are from release until on deck]. HOMER’s yo-yo sphere with instruments and microstructure data was lost along-side; it was seen in its cradle but disappeared within seconds and not seen while searching (0955-1025) with decreasing prospects. All equipment was recovered over the port side except the NIOZ lander through the stern A-frame. At 1300 an end to recoveries was declared (*F.S. Poseidon* had rolled considerably and waves had reached the deck during some recoveries). Deteriorating conditions were forecast; a south-easterly course was set via the Fair Isle channel for shelter, eventually off Wick from the morning of 22<sup>nd</sup> September.

On 23<sup>rd</sup> September *F.S. Poseidon* was forced to remain sheltering as gales covered all UK sea areas except *Thames*. These conditions precluded any attempt to return for the two remaining moorings, and at 1300 on 24<sup>th</sup> the decision was made to go to Aberdeen where a berth was available from the morning of 25<sup>th</sup>. The pilot was picked up at 0819 and *F.S. Poseidon* docked in Aberdeen at 0900 on 25<sup>th</sup> September.

## 5. TECHNICAL REPORTS

### 5.1 ADCP moorings

(John Wynar, UKORS, jbw@noc.soton.ac.uk; Mike Smithson, POL, msm@pol.ac.uk)

*Acoustic Tests (UKORS).*

UKORS acoustic releases to be used in the moorings were tested on the evening of 6<sup>th</sup> September as the vessel reached the work area. The four primary releases were chained to the CTD wire and lowered to a depth of 600m. They were then interrogated using a TT301 deck unit s/n: 140 and an over-side transducer. The results of the test are summarised below:

RT661 S/N	Range (m)	Diagnostic	Release (range)	Executed (Y/N)
183	595	3127	550	Y
255	596	3420	547	Y
163	540	3160	595	Y (see below)
321	594	4568	595	Y

After recovery, despite confirmation of the release function having been executed, it was apparent that RT661 #163 had not released. The command was sent to the unit whilst on deck and the RT661 responded immediately. However, subsequent commands had no effect. The decision was made not to use this unit in the deployment as its reliability was in question.

The spare unit, an AR361 s/n: 120, then had to be tested and was attached to the CTD wire in a similar manner as already described. The unit was lowered to 600m and tested with the results:

Range 598m; Release (range) 597m (executed). The test was successful and the unit substituted for the faulty RT661.

*Acoustic Release Codes*

S/N	54	120	183	255	321
MODE	B	A	B	B	A
WINDOW			EC2A	EC62	C446
RELEASE	EA56	EA25	(W)EC85	(W)EC85	(W)C485
PINGER			(W)EC94	(W)EC94	C470
OFF/DISABLE	EA55		EC2C	EC64	C448
INTERROGATE		EA26			
DIAGNOSTIC			(W)EC87	(W)EC87	(W)C487
ENABLE	EA54				

*Deployments.*

“North” ADCP (UKORS). This mooring used a 75kHz Long Ranger ADCP, s/n: 1767, mounted in a syntactic sphere (see Fig. 5.1a) at 6 mab. The mooring was designed to be as close to the sea floor as possible. It used a Seimac Argos beacon (id: 10117, s/n: 11713) as an emergency recovery aid.

Deployed: 1702 – 1704 on 7/9/05, 60° 15.01'N, 4° 41.31'E, water depth 653m (uncorrected).

Release: RT661#255

Instrument Start time 1351, 05/09/05, 2-min ensembles of pings @ 1s.

The script file sent to configure the ADCP follows, supplied by J Wynar, UKORS:

```
CR1
CF11101
CQ0
EA00000
EB00000
ED02500
ES35
EX11111
EZ1111111
TE00:02:00.00
TP00:01.00
WB1
WD111100000
WF0704
WN030
WP00120
WS0800
WV170
CK
CS
;Temperature      = 5.00
;Frequency        = 76800
;Deployment hours = 528.00
```

[Recovery was by *Poseidon* on 30<sup>th</sup> September 2005: time released, 17:45, time grappled from ship, 17:59, position 60° 15.11'N, 004° 41.18'W; time on deck, 18:02].

*“East” ADCP (UKORS).* This used the UKORS bed-frame lander (see Fig. 5.1b) and a 600kHz Sentinel ADCP, s/n: 3725, at 2 mab. A Novatech flashing light was attached to the frame as a recovery aid, and a Novatech AS900A Argos transmitter fitted as an emergency beacon.

Deployed: 1724 on 7/9/05, 60° 14.49'N, 4° 37.22'E, water depth 597m (uncorrected).

Release: RT661#54

Instrument start time 1451, 05/09/05, stop time 0730, 22/09/05, 2-min ensembles of pings @ 2s.

Below is the script file for the configuration of the ADCP supplied by J Wynar (UKORS):

```
CR1
CF11101
EA00000
EB00000
ED00000
ES35
EX11111
EZ1111111
TE00:02:00.00
TP00:02.00
WB0
WD111100000
WF0088
WN030
WP00060
WS0200
WV170
CK
CS
;Temperature      = 5.00
;Frequency        = 614400
;Deployment hours = 480.00
```

For recovery, ranges obtained using a TT301 (s/n: 84) with an over-side transducer were 503m, 629m. (These ranges from AR361 #54 were not always consistent with the water depth.)

Water depth 597m, Position 60°14.51'N, 4°37.04'W, Release command sent 06.26.

Recovered: 06.44 on 21/9/05.

To avoid interfering with the beams of the ADCP, the recovery line had been secured to the frame with PVC tape. When the vessel came alongside the lander, the line could easily be detached using a boat hook, the line then being wound onto a capstan winch to recover the instrument frame.

The ADCP was pinging when recovered. Later, when the data from the ADCP were examined, it was found to have recorded good-quality data during the deployment period.

*“West” and “South” ADCPs (POL).*

Both POL ADCPs were deployed on modified POL pop-up ADCP frames. These had been fitted with five Benthos glass buoyancy spheres replacing the old metal buoyancy tubes which would not withstand the pressures at the proposed deployment depths. Each frame was attached to a releasable aluminium bed frame fitted with lead ballast weights. A 12 m stray-line with pellet floats was attached to the top of each frame to facilitate recovery. The release

mechanism was a standard titanium release fitted with two “fizz link” burn wires. Each of these can be fired independently, only one being needed to release the instrument frame. Each frame was fitted with one RD Instruments 150 kHz broadband ADCP, one Vemco Minilog temperature logger and two Benthos transponding releases.

Both ADCPs were set up identically, the combination of depth cell number/size and ping regime being determined by the available memory (32 Mbytes) and battery capacity of the instruments. The setup is shown in Table 5.1. There were problems erasing the memory of ADCP number 1149. After several attempts with the RDI Windows software the old DOS software was tried and this was successful. The ADCP then appeared to operate normally.

Table 5.1. POL ADCP setup (“west” and “south”) and details of the instruments

Number of depth cells	60
Depth cell size	4 m
Time per ensemble	2 minutes
Time per ping	4 s
Number of pings per ensemble	30
Data recorded	Velocity, correlation, echo intensity, percent good, heading, temperature, pitch, roll
Coordinates	Radial beam coordinates
Pitch and roll correction	No correction applied

Frame A – “south” ADCP deployment						
Instrument	Serial number	Deployment details		Recovery details		Data
		Clock set	First data	Last data	Time off	
RD Instruments 150 kHz ADCP, broadband	1148	18:23:00 4/09/2005	19:00:00 4/09/2005	15:46:00 21/9/05	15:48:40 21/9/05	18454 kbytes
Vemco 12-bit Minilog	2407	18:00 5/09/005	06:00:00 7/09/2005	14:52 22/9/05		Sampling @ 2 min, 17 kbytes, calibrated 07/2001
Benthos acoustic transponder	69679	Receive frequency 11.5 kHz, Transmit 12.0 kHz Enable code C; Release code D				
Benthos acoustic transponder	72850	Receive frequency 11.5 kHz, Transmit 11.0 kHz Enable code A; Release code F				

Frame B – “west” ADCP deployment						
Instrument	Serial number	Deployment details		Recovery details		Data
		Clock set	First data	Last data	Time off	
RD Instruments 150 kHz ADCP, broadband	1149	17:25:00 4/09/2005	22:00:00 4/09/2005	11:54:39 22/9/05	11:57:02 22/9/05	19194 kbytes
Vemco 12-bit Minilog	4476	18:00 5/09/005	06:00:00 7/09/2005	15:20 22/9/05		Sampling @ 2 min, 17 kbytes, calibrated 06/2005
Benthos acoustic transponder	71904	Receive frequency 10.0 kHz, Transmit 11.0 kHz Enable code A; Release code D				
Benthos acoustic transponder	72381	Receive frequency 11.0 kHz, Transmit 11.5 kHz Enable code B; Release code C				

Deployment was from the afterdeck using the A-frame and on-load release hook. The ADCP frames freefall to the seabed and were tracked to the bottom using the Benthos deck unit and

over-side transducer. Both transponders worked as expected on Frame B (“west” mooring site). For Frame A (“south” mooring site) there was no response from transponder number 69679. The other transponder worked as expected. All the transponders had been checked before deployment and were working normally.

Figure 5.1c shows the ADCP being deployed. Figures 5.1d and 5.1e show the release mechanism and minilog in more detail.

*Recoveries.* Both POL ADCPs (“west” and “south”) were recovered without difficulty. With the ship on station the overside transducer is lowered into the water and the enable command for the Benthos transponders is sent. The transponder can then be “pinged” to check that it is awake and to get a range to the instrument frame. The release command is then sent. The transponder should reply with 4 pings to confirm that the command has been received, although in practice these pings can be difficult to distinguish as the time between them is short. The burn wire takes several minutes to burn away and during this time the transducers are “pinged” at regular intervals. Reduction of the range at a regular rate is an indication that the frame has been released and rising to the surface. This was the first time that these frames had been deployed in this particular configuration so there was no prior information on how quickly they would rise; in fact they rose at just under  $1 \text{ ms}^{-1}$ . As with the deployment, there was no response from transponder number 69679 on Frame A. [This will need to be checked on return to POL]. Recovery was over the port side of the ship, the strayline being grappled and the frame being winched on board.

Data were downloaded from the ADCPs successfully. Details are given in Table 5.1. First inspection of the data indicates that the ADCPs recorded successfully. However, the ensemble length for ADCP no. 1149 is not exactly 2 minutes as programmed; it is approximately 0.25 s longer and is not of constant length. This is the same ADCP with which there were problems erasing the memory when preparing it for deployment. It was noticed that the firmware version of this ADCP is earlier than the other, surprising as both were purchased at the same time and they have consecutive serial numbers. This needs to be investigated. The minilogs attached to the frames recorded successfully, details are also given in Table 5.1.

**POS328 NORTH  
ADCP BUOY**

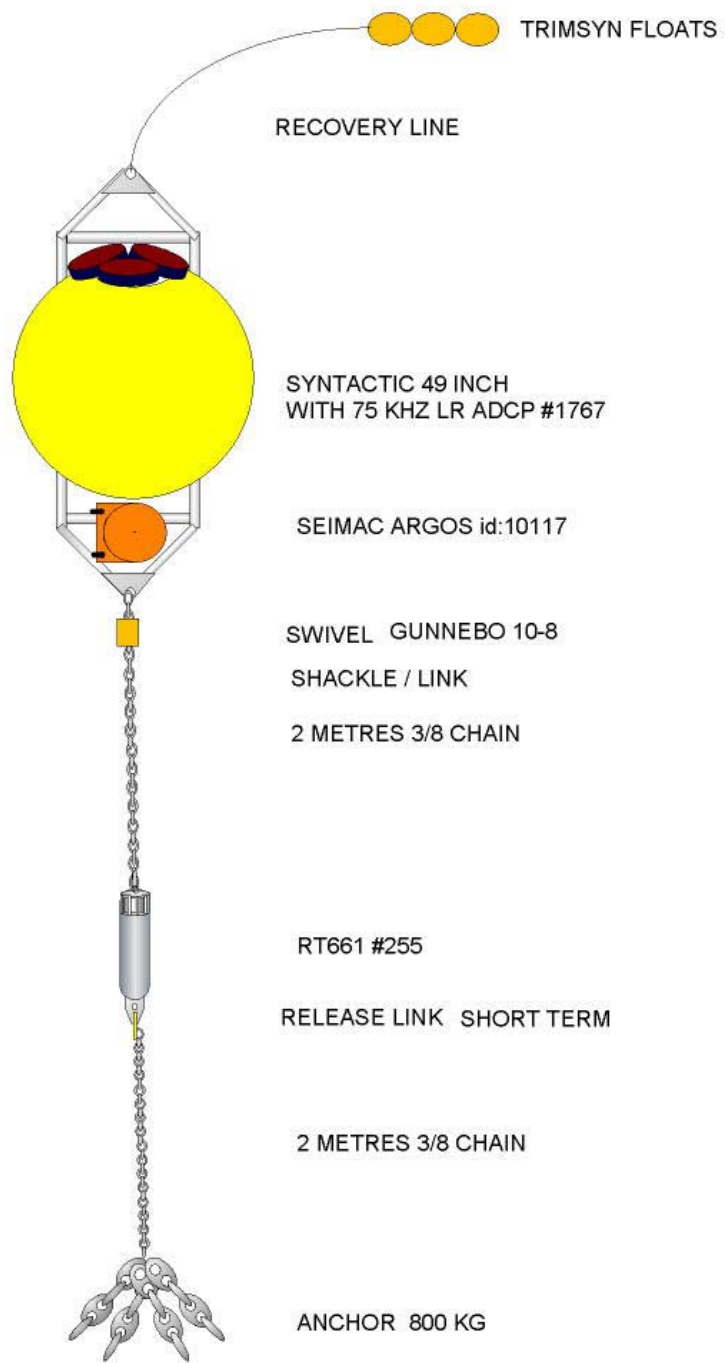

*Figure 5.1a*



**POSEIDON 328  
600KHZ ADCP LANDER**

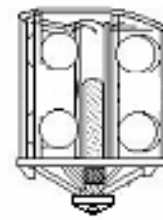
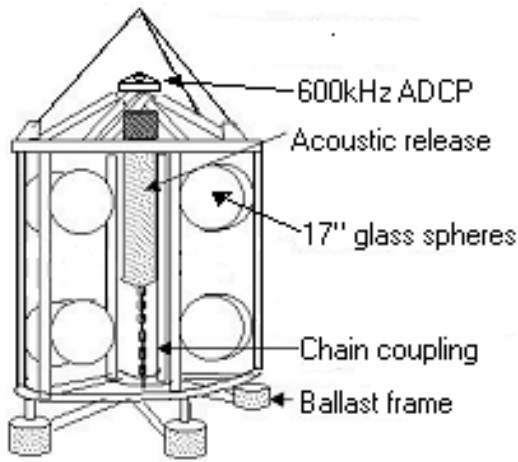

On arrival at the surface the lander is inverted

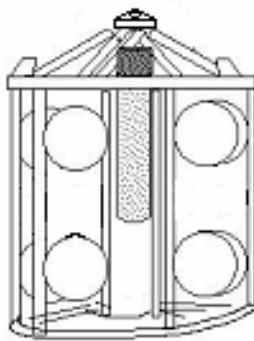

When commanded the acoustic release hook opens dropping the coupling chain and the lander framework rises from the ballast frame

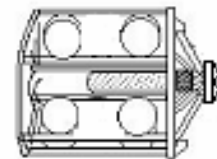

As the lander rises it rotates

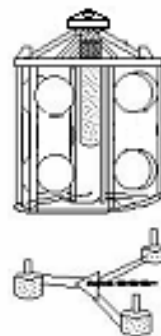
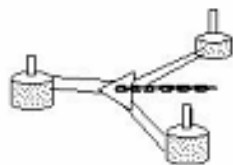

Figure 5.1b

Figure 5.1c. POL ADCP deployment

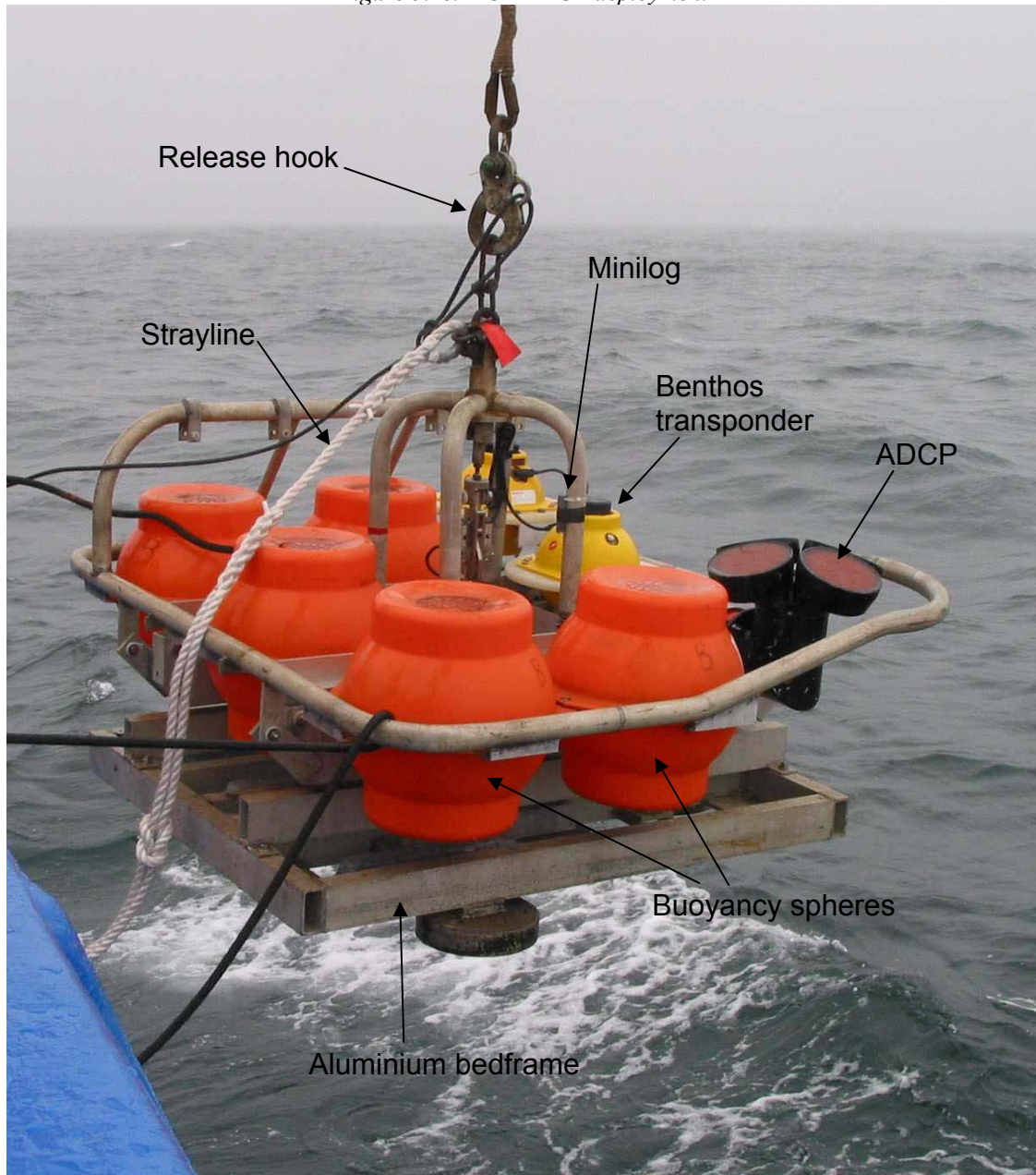

Figure 5.1d. Titanium release and “fizz link”



Figure 5.1e. Vemco minilog attached to ADCP frame



## 5.2 Temperature-logger moorings

(John Wynar, UKORS, [jbwy@noc.soton.ac.uk](mailto:jbwy@noc.soton.ac.uk), Mike Smithson, POL, [msm@pol.ac.uk](mailto:msm@pol.ac.uk))

*Acoustic Tests.* See 5.1.

*Deployments.*

Temperature logger moorings were deployed at the “west”, “east” and “south” sites. These moorings consisted of a 50 m mooring wire attached to a 500 kg anchor clump via an Oceano transponding release. Buoyancy was provided by either glass buoyancy spheres (west) or a syntactic barrel buoy (east and south). Each had a 15 m stray line and pickup float to aid recovery. Vemco Minilog temperature recorders were attached using cable ties and PVC tape at 4 m intervals along the mooring wire. The west and east moorings also had Seabird MicroCAT (temperature, conductivity and pressure) recorders at the deepest point, nominally 4 m above the bed. The Minilog sampling interval, either 2 minutes or 4 minutes, was determined by the memory capacity of the individual loggers.

The moorings were deployed from the afterdeck using the A-frame. The sub-surface buoyancy is deployed first followed by the mooring wire, instruments being attached at pre-marked intervals on the wire. The MORS release is attached to the bottom end of the wire followed by the anchor clump which is cut free when the ship is on station.

*Recoveries.*

All three minilog moorings were recovered successfully. Recovery was over the port side with the strayline attached to the sub-surface buoy being grappled first and the buoy winched onboard. This was then unshackled and the mooring wire attached to the winch. As the wire was wound in the minilogs were removed one by one until finally the Oceano release was brought onboard.

The data were not recovered from three of the minilogs (numbers 2198, 4482, and 4484). These appeared to be logging, but it was not possible to establish computer communications to allow the data to be downloaded. It may be necessary to return these to the manufacturer to extract the data. All the others appeared to have worked satisfactorily. Final details of each mooring are given in the respective tables below.

*“West” Minilog Mooring.* The mooring (see Fig. 5.2a) was deployed on the 7<sup>th</sup> September, and instrumented with 12 Vemco minilogs (supplied by POL) and a UKORS SBE37 microcat, s/n: 3250. The 4m spacing was decided upon to match the 4m bins of the ADCP moorings.

Deployed: 1358-1500 on 7/9/05, 60° 12.896'N, 4° 41.835'E, water depth 601m (uncorrected).

Release: RT661#321

*Recovery.* Ranges obtained using a TT301 (s/n: 84) with an over-side transducer: 599m, 601m. (RT661 #321 responded with consistent, unambiguous ranges.)

Water depth 601m, Position 60°12.95'N, 4°41.71'W, Release command sent 0821.

Recovered: 0841 on 21/9/05. The ascent rate of the mooring was estimated as 100m/min.

*“West” temperature mooring. Time of first data ensemble for all minilogs is 06:00 on 7/9/05, and for the Seabird MicroCat 1200 on 8/9/0. Minilog number 7334 was provided by SAMS.*

<i>Instrument</i>	<i>Serial number</i>	<i>Nominal height above bed (metres)</i>	<i>Logging interval (minutes)</i>	<i>Time (GMT) of last data ensemble</i>	<i>File size (bytes)</i>	<i>Calibration date</i>
Vemco Minilog	2421	50	2	07:38 on 23/9/05 (off at 07:39:39)	17702	7/2001
Vemco Minilog	2186	46	4	08:04 on 23/9/05 (off at 08:06:19)	9034	8/2004
Vemco Minilog	7334	42	2	08:24 on 23/9/05 (off at 08:24:39)	17738	12/2005
Vemco Minilog	2198	38	4	See text		8/2004
Vemco Minilog	2111	34	2	09:36 on 23/9/05 (off at 09:36:39)	17792	6/2005
Vemco Minilog	2195	30	4	09:48 on 23/9/05 (off at 09:49:29)	9073	8/2004
Vemco Minilog	2105	26	2	09:54 on 23/9/05 (off at 09:55:39)	17805	6/2005
Vemco Minilog	2184	22	4	10:00 on 23/9/05 (off at 10:03:29)	9078	8/2004
Vemco Minilog	2420	18	2	10:08 on 23/9/05 (off at 10:08:39)	17815	7/2001
Vemco Minilog	2191	14	4	10:16 on 23/9/05 (off at 10:16:29)	9084	8/2004
Vemco Minilog	4482	10	2	See text		6/2005
Vemco Minilog	2197	6	4	10:28 on 23/9/05 (off at 10:29:39)	9088	8/2004
Seabird MicroCAT	3250	4	1	1511 on 21/9/05		
Oceano release type RT661	321					

*“East” Minilog Mooring.* This mooring (see Fig. 5.2b) was instrumented similarly to the “West” one using Vemco minilogs supplied by POL and a UKORS microcat, s/n: 3273.

Deployed: 0800-0827 on 8/9/05, 60° 14.41' N, 4° 37.46' E, water depth 597m (uncorrected).

Release: RT661#183

*Recovery.* Ranges obtained using a TT301 (s/n 84) with over-side transducer: 729m, 737m.

(RT661 #183 gave ranges consistent with the water depth and probable distance from the ship.)

Water depth 599m, Position 60°14.58' N, 4°37.05' W, Release command sent 0647.

Recovered: 0701 on 21/9/05.

*“East” temperature mooring. Time of first data ensemble for all minilogs is 06:00 on 7/9/05, and for the Seabird MicroCat 1200 on 8/9/05. Minilogs numbers 7333, 5230, 8961 and 8947 were provided by SAMS.*

<i>Instrument</i>	<i>Serial number</i>	<i>Nominal height above bed (metres)</i>	<i>Logging interval (minutes)</i>	<i>Time (GMT) of last data ensemble</i>	<i>File size (bytes)</i>	<i>Calibration date</i>
Vemco Minilog	2187	53	4	17:12 on 22/9/05 (off at 17:14:19)	8700	8/2004
Vemco Minilog	2106	49	2	17:38 on 22/9/05 (off at 17:39:39)	17073	6/2005
Vemco Minilog	7333	45	2	18:02 on 22/9/05 (off at 18:03:29)	17090	12/2005
Vemco Minilog	5230	41	4	17:04 on 22/9/05 (off at 17:33:39)	8698	12/2005
Vemco Minilog	2108	37	2	18:30 on 22/9/05 (off at 18:31:39)	17112	6/2005
Vemco Minilog	2112	33	2	18:12 on 22/9/05 (off at 18:13:39)	17100	6/2005
Vemco Minilog	2193	29	4	19:20 on 22/9/05 (off at 19:23:39)	8732	8/2004
Vemco Minilog	2424	25	2	17:28 on 22/9/05 (off at 17:29:39)	17065	7/2001
Vemco Minilog	4484	21	2	See text		6/2005
Vemco Minilog	8961	17	4	17:52 on 22/9/05 (off at 17:55:39)	8716	12/2005
Vemco Minilog	2113	13	2	15:32 on 22/9/05 (off at 15:33:39)	16979	6/2005
Vemco Minilog	4483	9	2	19:02 on 22/9/05 (off at 19:02:59)	17119	6/2005
Vemco Minilog	8947	5	4	17:20 on 22/9/05 (off at 17:21:39)	8704	12/2005
Seabird MicroCAT	3273	4	1	1614 on 21/9/05		
Oceano release type RT661	183					

“South” Minilog Mooring. The “South” mooring (see Fig. 5.2c) was similar to the previous two minilog moorings except that there was no high-resolution Seabird instrument.

Deployed: 1017-1034 on 8/9/05, 60° 12.80'N, 4° 38.45' E, water depth 556m (uncorrected).

Release: RT661#120

Recovery. Ranges obtained using a TT301 (s/n: 84) with an over-side transducer: 586m, 590m. (RT661 #120 responded with consistent, unambiguous ranges.)

Water depth 556m, Position 60°12.90'N, 4°38.19'W, Release command sent 1236.

Recovered: 1256 on 21/9/05

“South” temperature mooring. Time of first data ensemble for all minilogs is 06:00 on 7/9/05. Minilog number 7340 was provided by SAMS.

Instrument	Serial number	Nominal height above bed (metres)	Logging interval (minutes)	Time (GMT) of last data ensemble	File size (bytes)	Calibration date
Vemco Minilog	7340	52	2	12:28 on 23/9/05 (off at 12:28:19)	17920	12/2005
Vemco Minilog	2408	48	2	12:36 on 23/9/05 (off at 12:37:39)	17926	7/2001
Vemco Minilog	2189	44	4	12:44 on 23/9/05 (off at 12:47:39)	9139	8/2004
Vemco Minilog	2427	40	2	12:52 on 23/9/05 (off at 12:53:39)	17938	7/2001
Vemco Minilog	2423	36	2	13:00 on 23/9/05 (off at (13:01:39)	17945	7/2001
Vemco Minilog	2192	32	4	13:16 on 23/9/05 (off at 13:17:59)	9151	8/2004
Vemco Minilog	2104	28	2	13:22 on 23/9/05 (off at 13:22:29)	17961	6/2005
Vemco Minilog	2107	24	2	13:32 on 23/9/05 (off at 13:32:29)	17969	6/2005
Vemco Minilog	2196	20	4	13:40 on 23/9/05 (off at 13:40:29)	9160	8/2004
Vemco Minilog	2425	16	2	13:44 on 23/9/05 (off at 13:45:29)	17978	7/2001
Vemco Minilog	2110	12	2	13:54 on 23/9/05 (off at 13:54:39)	17985	6/2005
Vemco Minilog	2185	8	4	14:00 on 23/9/05 (off at 14:02:19)	9168	8/2004
Vemco Minilog	2426	4	2	14:20 on 23/9/05 (off at 14:20:39)	18004	7/2001
Oceano release type AR361	120					

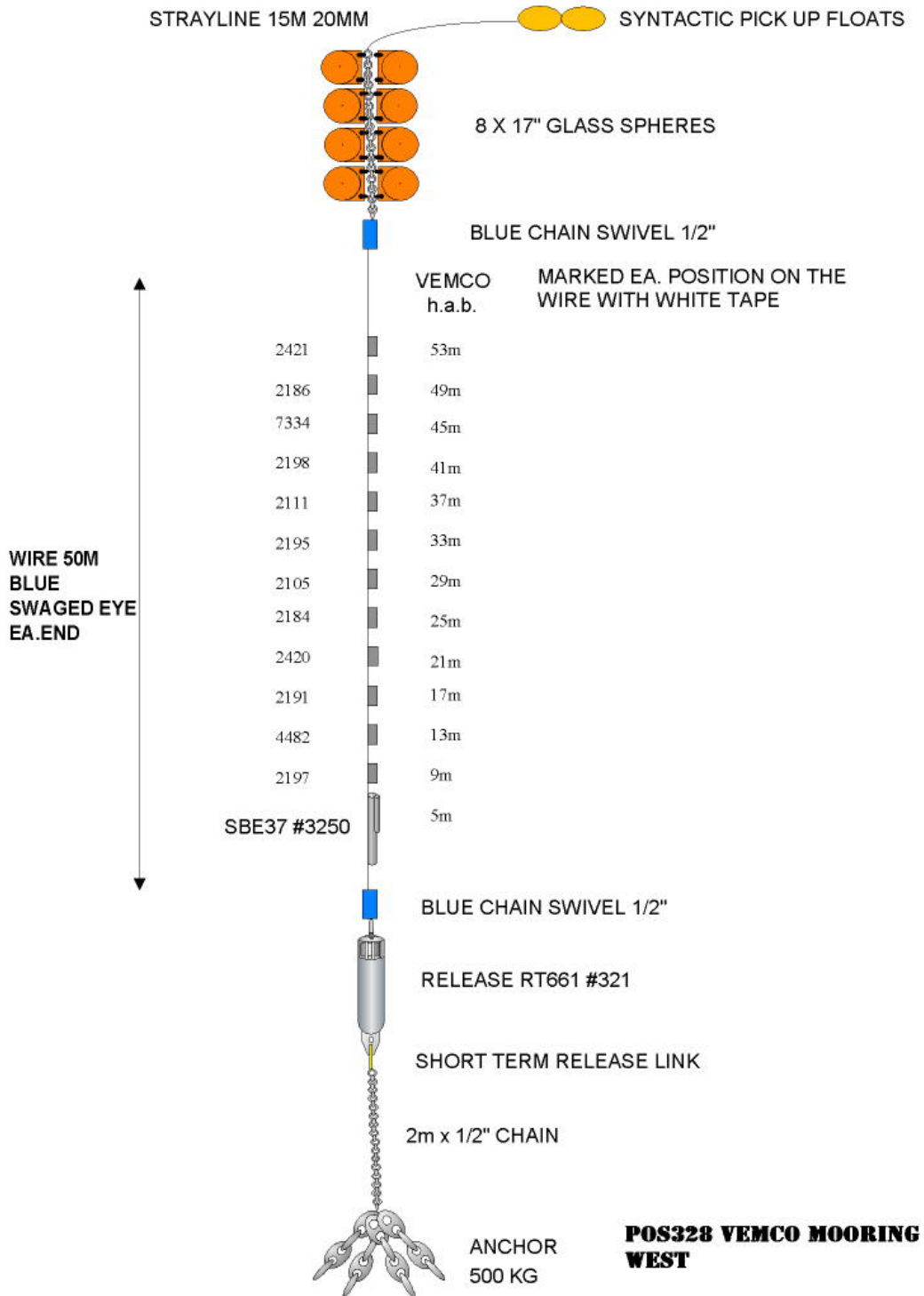

Figure 5.2a



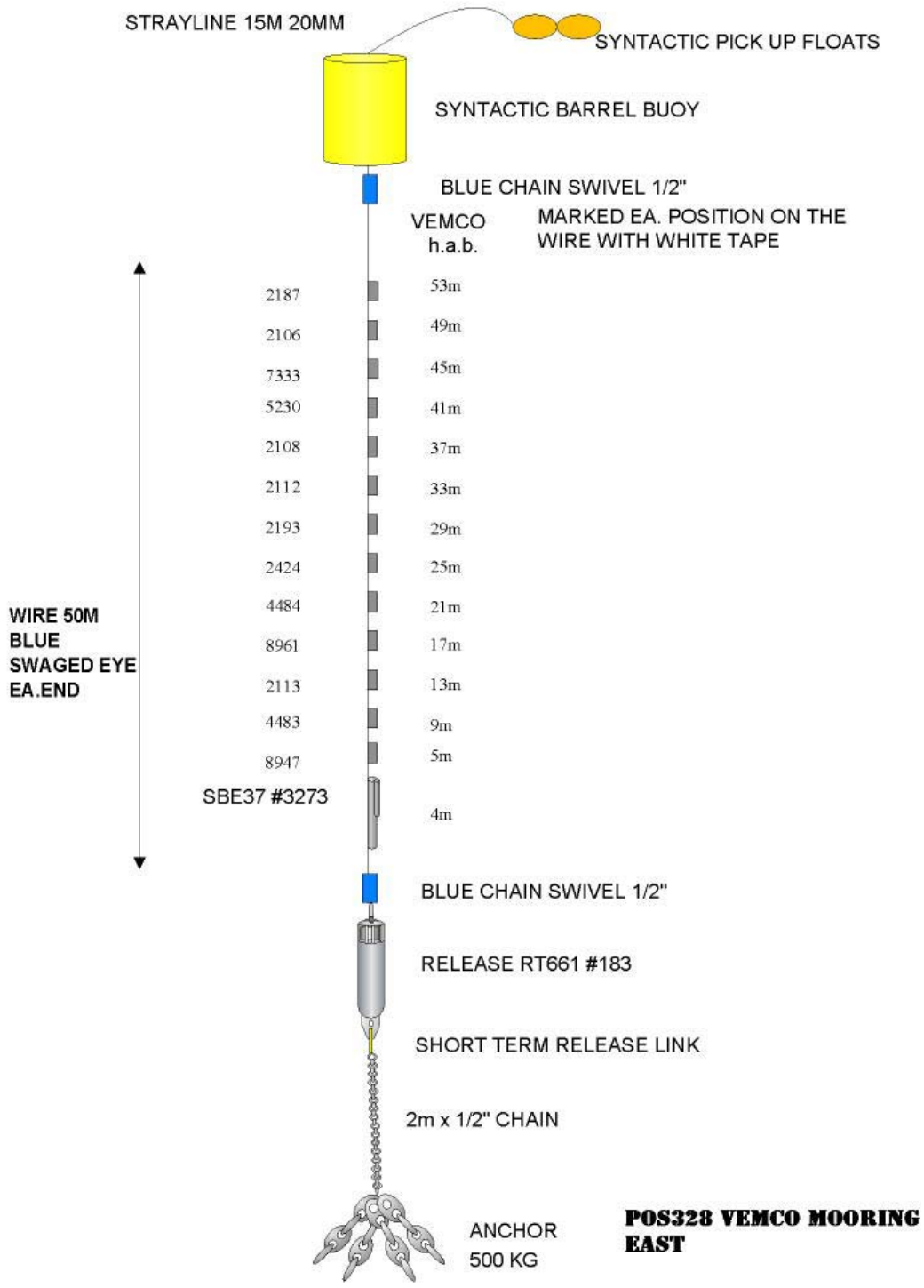

Figure 5.2b



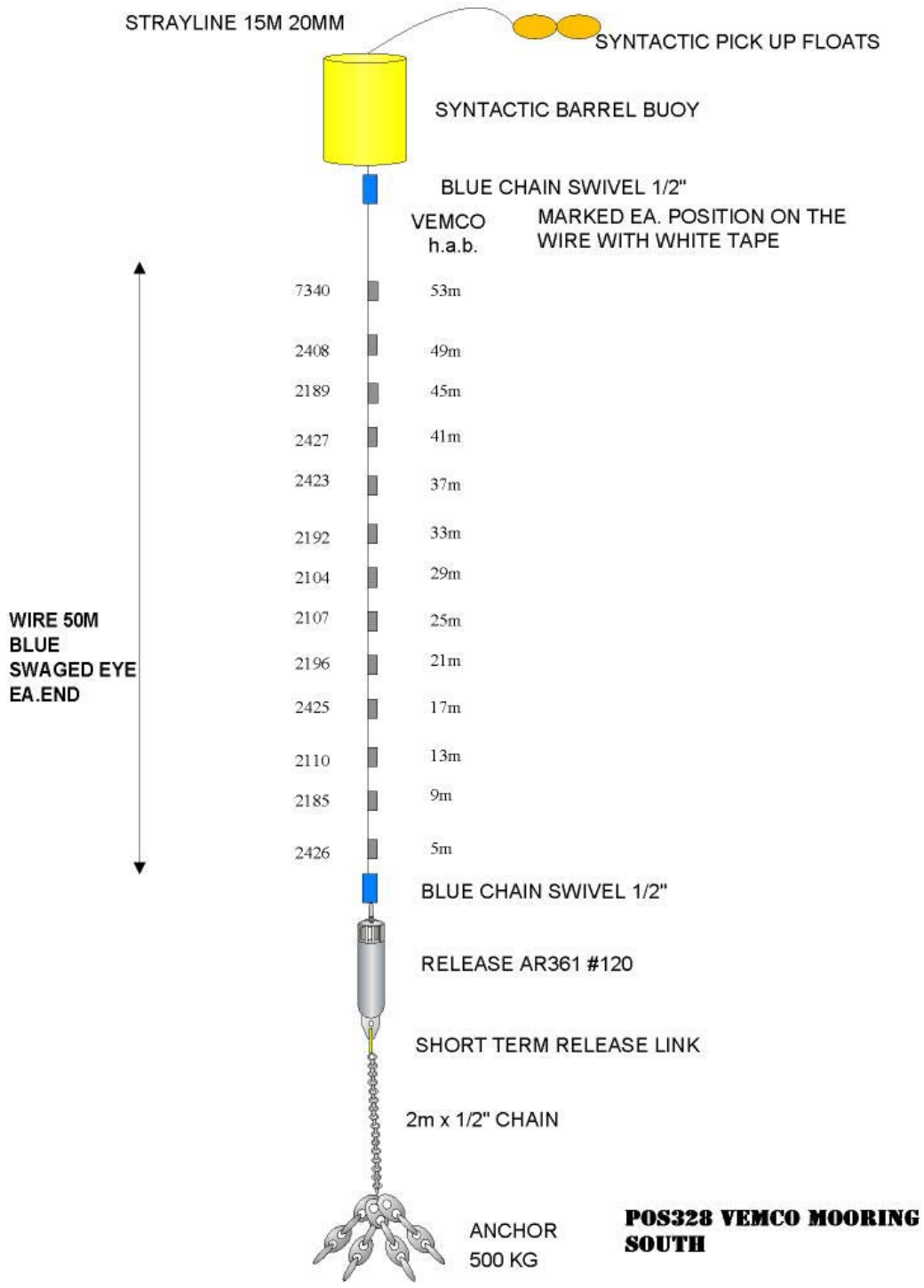

Figure 5.2c

### 5.3 STABLE (Mike Smithson, POL, msm@pol.ac.uk)

STABLE (Sediment Transport And Boundary Layer Equipment) consists of a 2.4 m diameter instrument frame supported on three legs such that sensors can be mounted in the water volume under the frame, while minimising the effect of the instruments on the water properties being measured. Lead feet weighing 150 kg each are attached to the legs and can be released simultaneously allowing the buoyant instrument platform to float free. Two transponding releases are fitted, each able independently to release all three lead feet. A third transponder is used as a “pinger” to range to the frame when it is on the surface. A 15 m strayline is attached to facilitate recovery. Netting over the top surface prevents the strayline from washing into the instruments.

STABLE has two data logging systems – a “burst” logger which triggers a number of sensors and samples them at high frequency, and a “mean” logger which records mean currents. The sensors connected to each logger are shown in Table 5.3a.

Deployment was from the port side deck of the ship using the side winch and on-load release hook. STABLE free-falls to the seabed at approximately  $1.1 \text{ ms}^{-1}$  and was tracked to the bottom using the acoustic transponders. All three operated normally down to the seabed. Figure 5.3a shows STABLE immediately prior to deployment. Figure 5.3b shows the sensors mounted underneath the instrument platform. [Recovery was by *Pelagia* on 1 October 2005: time released, 07:00, time grappled from ship, 07:15, position  $60^{\circ} 13.93' \text{N}$ ,  $004^{\circ} 38.69' \text{W}$ ; time on deck, 07:18].

Table 5.3a. STABLE sensors and sampling regimes. Calibration date for EMCMs: 2 August 2005.

Instrument	Serial number	Logger	Height above seabed (cm)	Sampling frequency	Time (GMT), day of first sample
POL electromagnetic current meter (EMCM)	B	Burst	30	8Hz, 20mins per hour	18:00, 5/09/2005
POL electromagnetic current meter	C	Burst	60	8Hz, 20mins per hour	18:00, 5/09/2005
Applied Microsystems temperature sensor	4209	Burst	30	8Hz, 20mins per hour	18:00, 5/09/2005
Applied Microsystems temperature sensor	4210	Burst	60	8Hz, 20mins per hour	18:00, 5/09/2005
POL acoustic backscatter at 700kHz, 2MHz, 4MHz		Burst	122	8Hz, 20mins per hour	18:00, 5/09/2005
Mean current rotor		Mean	33	1 min average	17:05, 5/09/2005
Mean current rotor		Mean	51	1 min average	17:05, 5/09/2005
Mean current rotor		Mean	69	1 min average	17:05, 5/09/2005
Mean current rotor		Mean	87	1 min average	17:05, 5/09/2005
Mean current vane		Mean		1 min average	17:05, 5/09/2005

Benthos acoustic transponder (pinger)	Receive frequency 11.5 kHz, Transmit frequency 12.0 kHz, (Release code C)
Benthos acoustic transponder (release)	Receive frequency 14.0 kHz, Transmit frequency 12.0 kHz, Release code C
Benthos acoustic transponder (release)	Receive frequency 15.0 kHz, Transmit frequency 12.0 kHz, Release code C

Figure 5.3a. STABLE immediately before deployment

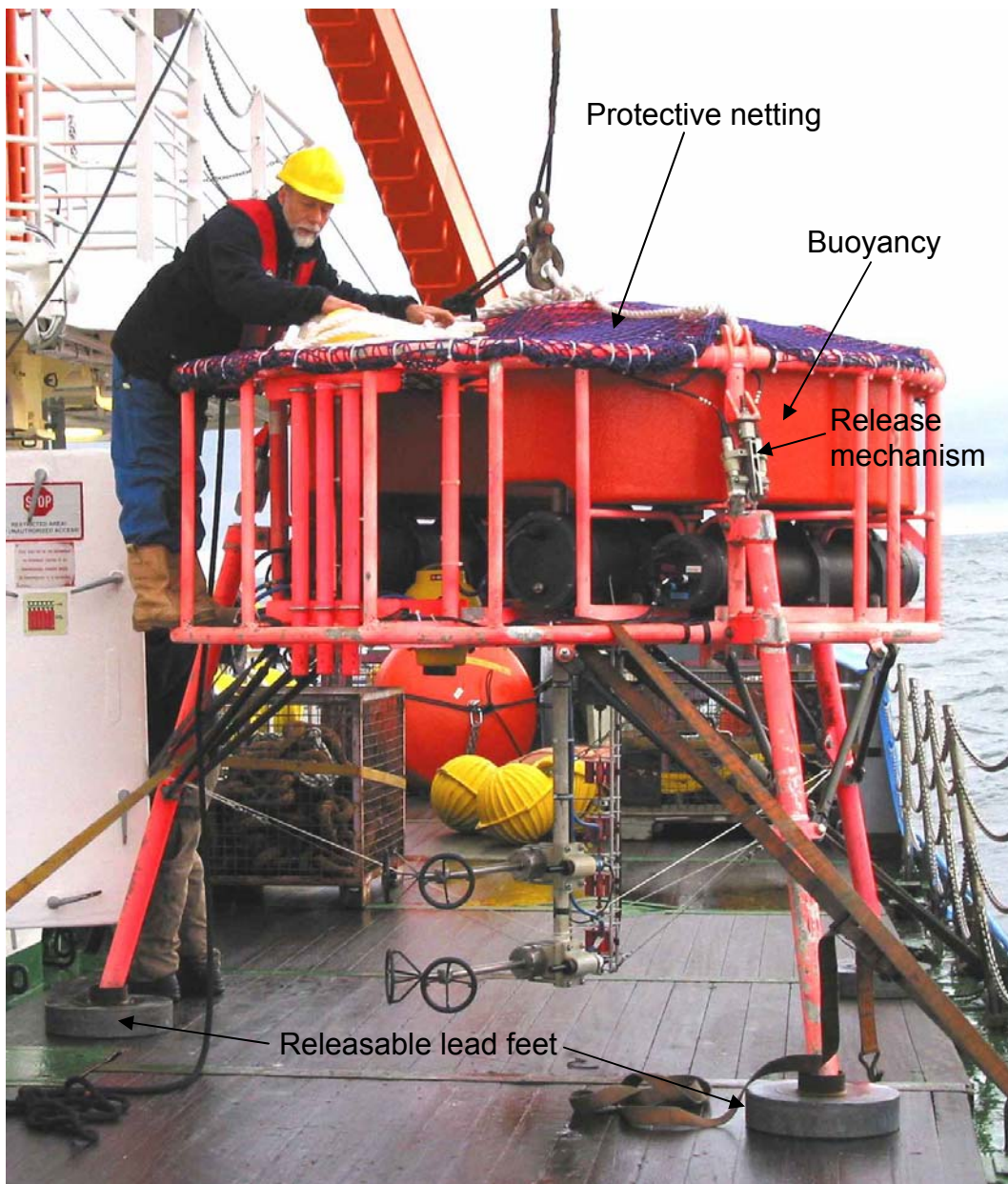
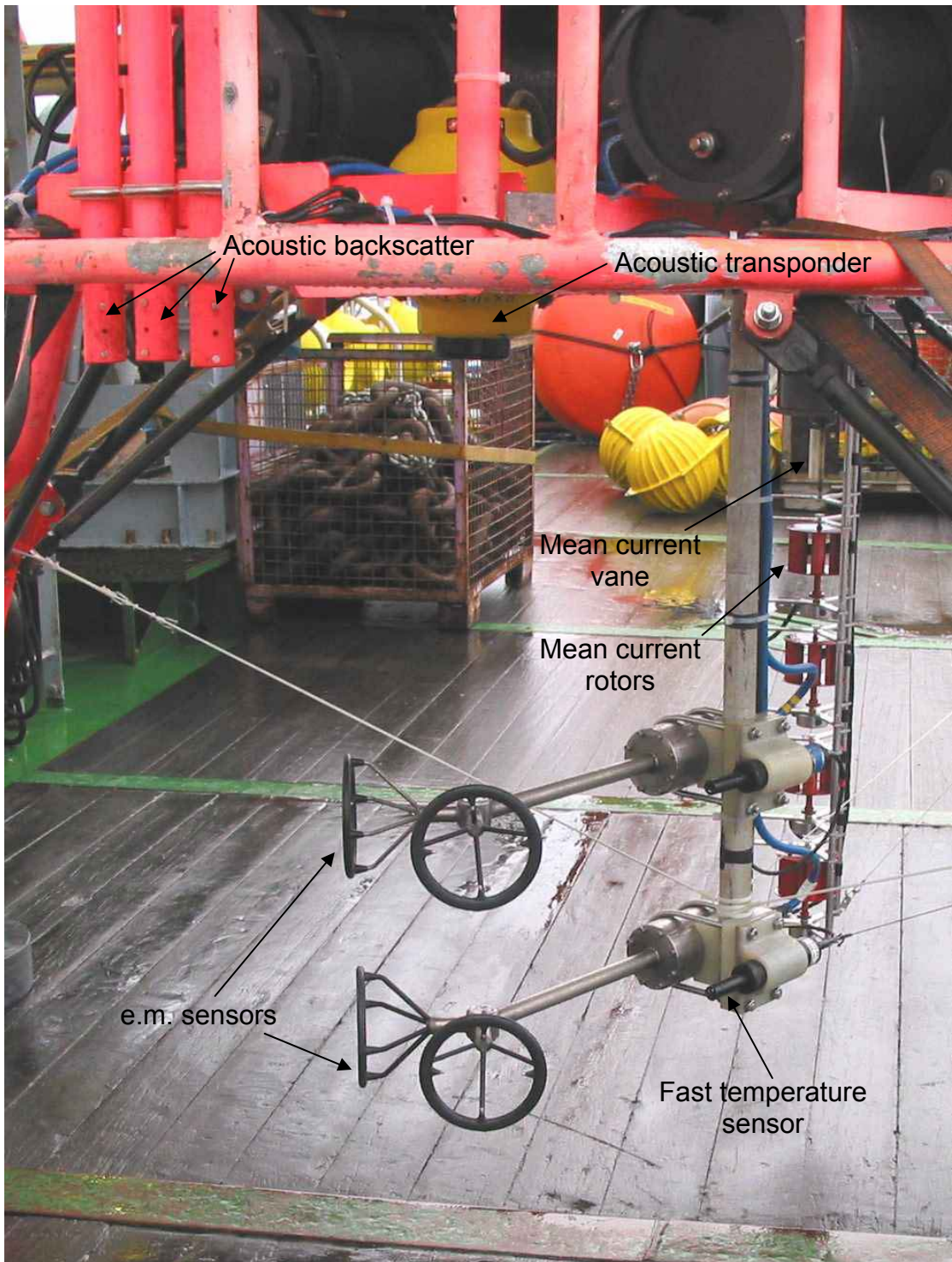



Figure 5.3b. STABLE sensors



#### 5.4 HOMER with ADCP (Mark Inall, SAMS, mark.inall@sams.ac.uk)

The HOMER deep water vertical profiler (HOMing Environmental Recorder), originally devised at the Proudman Oceanographic Laboratory, has recently been further developed at the Scottish Association for Marine Science (SAMS). The HOMER system comprises a seabed resident winch which repeatedly releases and recovers a buoyant, internally-recording, 0.25m diameter spherical sensor module. For this deployment a shear micro-structure profiler was attached to the sensor sphere. The sensor package performs CTD (conductivity, temperature, depth) and shear and temperature micro-structure profiles of the water column from the seabed to a pre-programmed altitude. In its present deployment configuration for



Figure 5.4. Schematic drawing of HOMER (without shear microstructure sensors)

Poseidon 328 HOMER was programmed to perform a total of 96 profiles at 3-hourly intervals to a height of 150m above the bed in a water depth of ~600m. Winch control is performed through an embedded microcontroller that instructs a pair of oil filled brushless DC motors; one motor drives the main take-up spool and the other drives a capstan which controls the ascent and decent rate. Power is supplied through a bank of standard lithium D-cells. Sensor sphere and winch are connected via a non-conducting mono-filament line. An infra-red link transfers data from the sensor sphere to the sea-bed frame control sphere between profiles to minimise the risk of data loss. The entire instrument remains on the seabed between profiles.

In addition to the profiling sensor package, the bed frame was instrumented with:

1. An RDI 300 kHz Sentinel ADCP (SN 6358), set up to record 100 two-metre bins, 1<sup>st</sup> bin centred at 4.5 mab, with 100 pings per 2-minute ensemble, for a total duration of 15 days. The 1<sup>st</sup> ensemble was at 0800 on 05/09/05, the last at 1136 on 13/09/05.
2. An un-pumped Seabird SBE37 microcat (SN 4082), 1 mab, set up to record temperature, conductivity and pressure at one-minute sample interval. The first scan was at 1251 on 06/09/05, the last scan at 1126 on 22/09/05.

HOMER (SN HP2.2) was deployed in 597m water depth at 0930Z on 7<sup>th</sup> September 2005 at position: 60° 13.65'N, 04° 39.61'W.

#### *Recovery and data:*

Recovery was on 21<sup>st</sup> September 2005. During recovery the sensor sphere package tether parted and the package was lost. No microstructure data recovery will now be possible; it is not clear yet whether CTD data were successfully transferred via the IR link to the main winch sphere. If data were successfully transferred there will be 96 vertical profiles of conductivity, temperature and pressure; one cast every three hours from seabed to 150m above the bed.

The ADCP battery pack prematurely failed after 6.5 days. 5.5 MB of good data in RDI binary file format were recovered from the recorder. The microcat functioned without fault and a full record was recovered from the recorder (1.4MB ascii file).

Initial analysis of the ADCP and microcat records shows considerable high frequency internal wave activity: packets of solitons of elevation propagating up-slope with quasi semi-diurnal frequency over a period of 4 days, ending abruptly on 10<sup>th</sup> September.

### 5.5 NIOZ ADCP/thermistor-string bottom-lander

(Hans van Haren, NIOZ, P.O. Box 59, 1790 AB Den Burg, Netherlands, hansvh@nioz.nl)

Fast sampling (0.5 Hz) and large storage capacity instrumentation is used to study details of strongly non-linear processes associated with sloping bottoms. Large steep fronts of up to 50 m above the bottom can pass the mooring within a minute, whilst they trail a sequence of non-linear waves (Hosegood and van Haren, 2004). As such strong non-linear motions occur infrequently, either at a tidal time-scale, or at a sub-inertial time-scale, fast-sampling is required over a period of at least two weeks. The purpose within ‘Slope mixing’ is to learn more about the details of such non-linear waves, and their occurrence, in the hope to establish their (dominant) generation mechanism. After all, these strong non-linear motions are important for sediment resuspension (Hosegood et al., 2004) and, to a lesser extent, mixing above sloping bottoms.

A fast sampling mooring (Fig. 5.5a), the NIOZ-built bottom-lander ‘MixBB-002’ (Fig. 5.5b) was deployed at the central mooring position of ‘Slope mixing’. The mooring held an upward looking 300 kHz RDI Sentinel ADCP (s/n 6227), with two extra battery containers and extended memory (2 GB), and a 2 MHz Nortek AquaDopp current meter (s/n P286-2). Both instruments were at ~1.75 m above the bottom (mab). The AquaDopp sampled once every 5 s a single depth cell at ~3.0 mab, whilst the first of 80 1 m depth cells of the ADCP was at ~6.0 mab. The ADCP averaged 4 pings in 2 s ensembles. Attached to the frame via a double release mechanism was a fast sampling NIOZ thermistor string (s/n NIOZ002), under a second 2 MHz Nortek AquaDopp current meter (s/n P286-1) that was 4 m below a 200 kg sub-surface elliptic buoy. The NIOZ thermistor string held 112 sensors every 0.5 m (the upper section of nominally 16 sensors was void) that were sampled once every 2 s. Unfortunately, due to casting problems regularly sensors fail. Just prior to deployment 9 sensors failed.

Prior to deployment the entire rig was assembled on deck, including hanging the 450 kg dropping weight from the two Benthos acoustic releases (s/n 949 and 1003) and attaching an ARGOS transmitter to the top of the lander (s/n 12554; ARGOS code 21510). The overboard operation went very smoothly, including that of the 1.2 tons weighing frame, which went last. All instruments started sampling (1<sup>st</sup> scan) at 10:00 UTC on 07 September 2005, and the mooring was at the bottom from 12:15 UTC on the same day.

The recovery of the separately-surfacing buoy/thermistor string and the lander itself went also without problems, except that it took some five minutes before the lander actually started to come up. The buoy/thermistor string was hoisted on deck via the open port-side, the lander via the stern. No damage was done to any of the instruments.

The ADCP and both AquaDopp current meters collected the expected amount of data: last scans/ time off were: AquaDopp at 1706:36, 21/09/05; ADCP at 1411:24, 21/09/05. The range of good data in the ADCP was quite good: about 60 m, sometimes more. Very unfortunately, the thermistor string recorded only 3 hours of data. This had happened once in the past, but apparently was not successfully repaired: a recorder problem.

All parameters measured by the instruments (whether current components  $u$ ,  $v$  or  $w$ , or temperature, pressure or echo intensity) showed an abundance of near-bed solitary and high-

frequency internal waves, although with highly varying amplitudes. A first rough glance suggested the coupling between these high-frequency internal motions and the tide.

Figure 5.5a. Mooring diagram, NIOZ bottom lander. Not indicated separately are the current meters in the frame and above the thermistor string data logger.

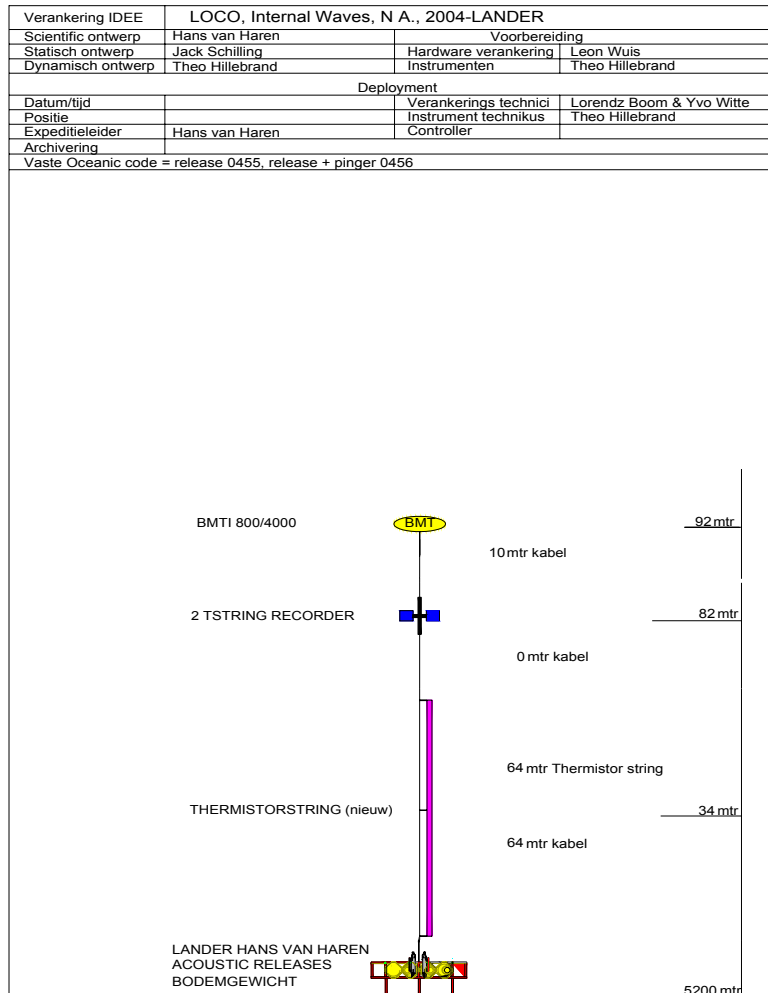

Figure 5.5b. NIOZ bottom lander, with ARGOS transmitter (far top-left) 300 KHz ADCP (top-left) and 2 extra battery containers below ADCP (difficult to see), AquaDopp (top far-right), 2 acoustic releases (grey/black cap central pipes) and free suspended dropping weight. The black cable attached to the central top and free hanging to the lower-right is the NIOZ thermistor string (leading to the buoy already in the water).





## 5.6 CTD (with LADCP, see also 5.7)

(Christopher Smarz, IfM-GEOMAR, csmarz@ifm-geomar.de)

LADCP/CTD/rosette casts were performed with a package consisting of a 12-bottle rosette frame (Seabird), a 12-place pylon (SBE32) and 12 10-litre bottles (OTE). Underwater electronic components consisted of a Seabird Electronics (SBE) *9plus* CTD with pump, temperature (SBE3), conductivity (SBE4), oxygen (Beckmann/YSI), sonar altimeter (datasonics) and a RDI LADCP (Workhorse 300 kHz). The CTD was mounted horizontally in the bottom centre of the rosette frame. The SBE sensors and pump were deployed horizontally along the CTD pressure case. The LADCP was mounted alongside and outboard the CTD frame with transducers pointing down.

Rosette Underwater Electronics		
Unit	SerialNumber	CalibrationDate
SeaBird32 12-place Carousel Water Sampler	3210108-0091	no cal.
since cast 036 station 607 " " "	3225212-0342	no cal.
SeaBird SBE <i>9plus</i> CTD	09P10108-0410	no cal.
Paroscientific Digiquartz tc Pressure Sensor	61184	Dec 04
SeaBird SBE <i>3plus</i> Temperature Sensor	32120	Dec 04
SeaBird SBE 4C Conductivity Sensor	1494	Jun 04
SeaBird Oxygen Sensor Beckmann/YSI	130398	Nov 01
Datasonic PSA-900 Sonar Altimeter	453	no cal
RDI Workhorse 300kHz Sentinel LADCP	936	no cal.

The SBE *9plus* CTD was connected to the SBE *11plus* deck unit for single-conductor sea cable operation. Power to the SBE *9plus* CTD and SBE32 pylon was provided through the sea cable from the SBE *11plus* deck unit in the dry lab. The sea cable was a “Dataline” from tyco Electronics. The LADCP was powered by battery packs.

The port-side CTD winch W2 was used on all 105 CTD casts. The sea cable on this winch developed a kink due to storm surge twisting on cast 82; so the sea cable was reterminated. There was an initial start-up problem at cast 24. After restart, everything worked fine again. At cast 32 the water sampler carousel had a water intrusion and had to be changed.

The deck watch prepared the rosette 10-20 minutes prior to each cast. All valves, vents and lanyards were checked for proper orientation. The bottles were opened and the CTD was powered-up. Once stopped on station, the data acquisition system [CTD software acquisition SeaSave Win32 version 5.30a] was started and the LADCP was turned on. Two stabilising tag lines were threaded through the rosette frame, and the syringe was removed from the CTD sensor intake ports. The watch leader directed the winch operator to raise the package, the A-frame and the rosette were extended outboard and the package quickly lowered into the water. The tag lines were removed and the package was lowered to 10 metres, paused for typically 3 minutes and began the descent.

On all but a few casts, the rosette was lowered to within 4 metres of the bottom. Recovering the package at the end of the cast was essentially the reverse of launching.



### 5.7 Lowered ADCP (LADCP: Mark Inall, SAMS, mark.inall@sams.ac.uk)

A self-contained, 1000m rated RD Instruments (RDI) 300kHz ADCP (SN 0936), with bottom tracking enabled, was attached to the lower section of the CTD rosette frame in a downward-looking configuration. After each cast a single file was downloaded (LADCP firmware 16.27(0) to RDI binary format); a single 1000m file was typically 5MB.

Each cast file was processed using the widely used and freely available software written by Martin Visbeck (IFM Keil), running under MATLAB (R14). An example cast is shown below.

A defective power supply gave start-up problems on the first cast. So there are no data on this cast. The instrument failed to store full profiles on casts No. 017, 030, 060. No reason for these malfunctions was discovered. The LADCP was removed for casts 93 to 100 because the housing is only pressure rated to 1000 meters; these casts were deeper. The battery was changed once, between cast 93 and 100.

All LADCP casts were fully processed on-board, a total of 97 (95 full). Data return from each cast is one MATLAB format processed data file (~50kB per file), and one RDI format raw data file (~3.5MB per file). RDI and MATLAB files will be logged with BODC.

Casts 58-82 form a 24-hour station at 60° 15.65'N, 4° 42.4'W on 11-12 September.

### Station : 055

Start: 0°N 0.0000' 0°E 0.0000'

10-Sep-2005 23:33:17

End: 0°N 0.0000' 0°E 0.0000'

10-Sep-2005 23:56:57

*Figure 5.7. An example LADCP profile*

absolute velocity U(-) V(--); blue dots down cast; dotted shear

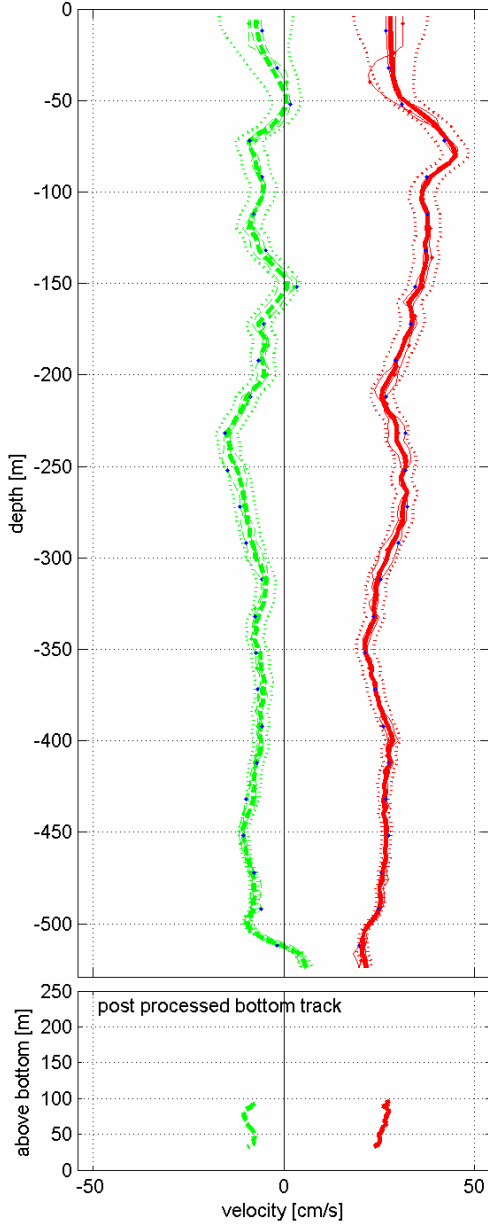

u-mean: 29 [cm/s] v-mean -7 [cm/s]  
 binsize do: 4 [m] binsize up: 0 [m]  
 mag. deviation NaN  
 wdiff: 0.08 pglim: 0 elim 0.5  
 smoo: 0.02 barofac: 0 botfac: 1 shear: 1  
 weightmin 0.05 weightpower: 1  
 max depth: 529 [m] bottom: 529 [m]

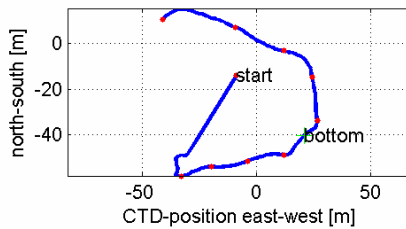
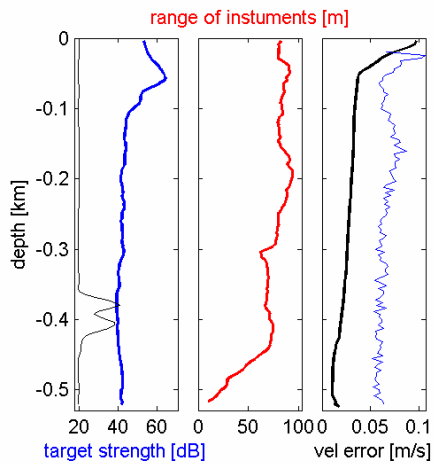

5.8 Vessel Mounted ADCP (VMADCP: Mark Inall, SAMS, mark.inall@sams.ac.uk)  
FS Poseidon is fitted with an RD Instruments 75kHz Ocean Surveyor ADCP. Positional and attitude information is provided via an Ashtech ADU2 multi-receiver GPS attitude sensor. Ship's heading information from the vessel's Gyro was not used. RDI proprietary software VMDAS was used to configure the ADCP and perform some data screening and coordinate mapping to the reference frame of the vessel. Bottom tracking was enabled. A suite of MATLAB routines was used to perform further data screening and transformation to absolute velocities in Earth coordinates. The configuration and processing steps were as follows.

*VMADCP Configuration:*

- No. bins = 100
- Bin size = 8m
- Blank after transmit = 8m
- Transducer depth = 5m
- Bottom track on, maximum depth 1300m
- Time between pings = as fast as possible (typically 5s)
- Low-resolution long-range processing mode

*MATLAB Processing:*

1. RDI binary file with extension ENX (single-ping ADCP data from VMDAS) and extension N1R (raw ascii NMEA output from ADU2 saved by VMDAS) read into MATLAB environment
2. Ensembles with no data removed
3. Ensembles with bad navigation data removed
4. ADU2 attitude information time-merged with single ping data
5. ADU2 heading data used to rotate single ping ADCP velocities from vessel centreline reference to True North reference
6. Transducer mis-alignment error corrected for (derived from calibration exercise – see text below)
7. Ship velocity derived from ADU2 positional information
8. Further data screening performed:
  - Four-beam solution only permitted
  - Max heading change between pings
  - Max ship velocity change between pings
  - Error velocity > 2 x (Standard deviation of error velocities of single ping profile)
9. All data averaged into 120-second or 300-second super-ensembles (user selectable)
10. Determine absolute water velocities from either bottom track derived ship velocity or ADU2 GPS derived ship velocity. Generally ADU2 velocity was used.

A calibration exercise, to determine the alignment angle of the ADCP transducer relative to the centreline, was carried out by steaming in a square of side 4km at 6kn. The alignment was determined by minimising for a component of the ship speed in the derived water velocity. The alignment angle was found to be -2.843 degrees. No amplitude correction was necessary.

The instruments (ADCP and Ashtech ADU2) both performed well during the cruise. A few GPS data drop-outs occurred, but for no more than a few seconds at a time. Water profiles were generally good (percent good > 50%) to ~600m, and Bottom Tracking was good down to ~1100m.

A repeat transect between 60° 15.65'N, 4° 42.4'W and 60° 7.0'N, 4° 28.0'W (~700m, 200m depth respectively) began at 0713 on 12<sup>th</sup> September; bad weather curtailed it at 2155 after four return passes and a fifth single pass to the SE. An example file of processed data from this repeat transect is shown in Figure 5.8.

Raw data files in RDI format and processed data files in MATLAB format will be logged with BODC after the cruise, the approximate total quantity of data will be 2.5GB. Data are divided into 16 series (series VMP328\_001 to VMP328\_016). Within each series, files are subdivided into files of maximum 10MB in size. Series number is incremented each time VMDAS is stopped and re-started; the number of sub-files per series is therefore variable.

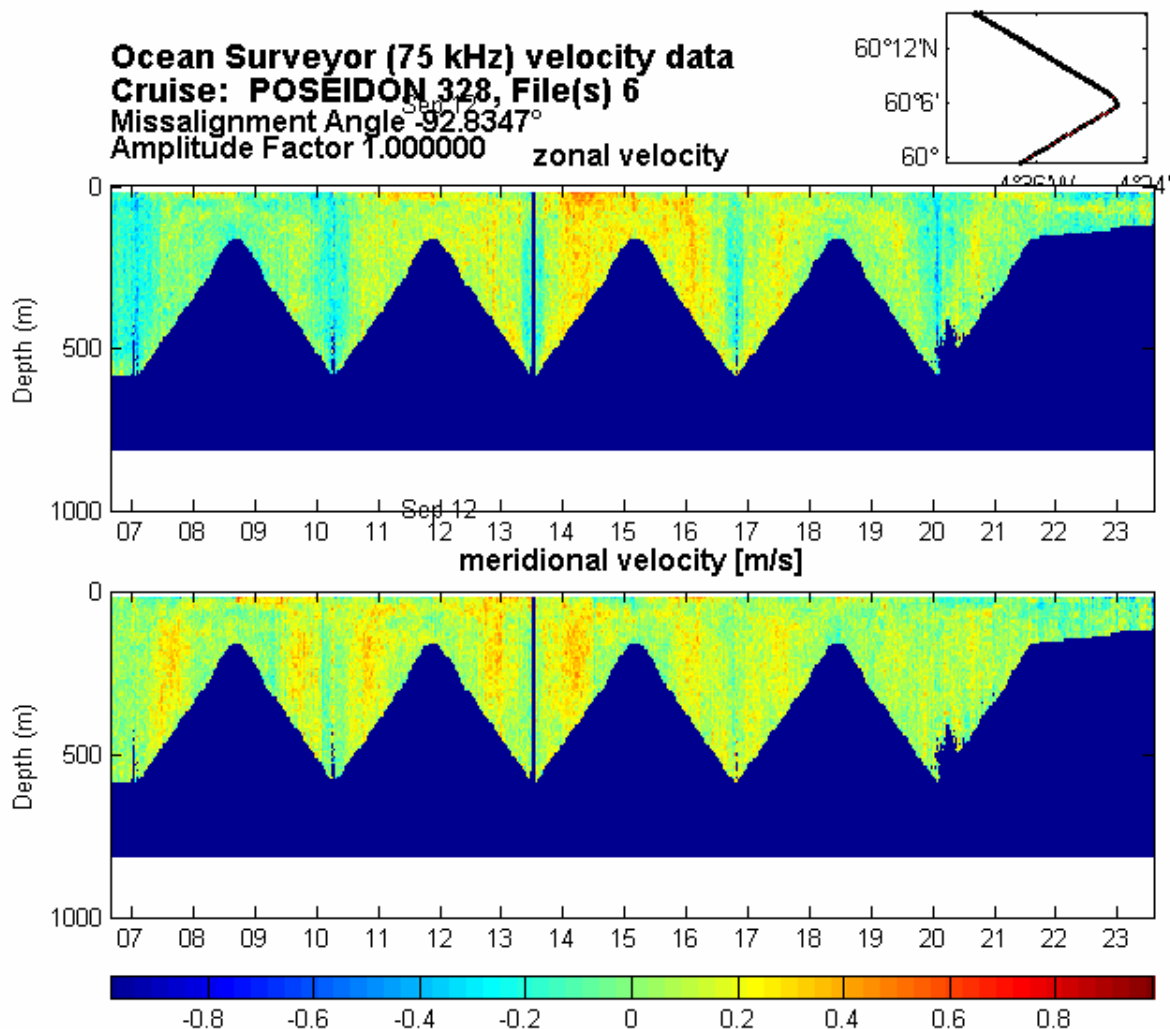

Figure 5.8. Processed VMADCP data during 13-hour cross-slope repeat transect survey.

### 5.9 Satellite images (John Huthnance, POL, [jmh@pol.ac.uk](mailto:jmh@pol.ac.uk))

Sea-surface temperature (SST) daily-composite images and weekly frontal analyses were obtained for information on the measurements' context, especially any slope current meanders and anomalous surface-temperature patterns. The following were received (as e-mail attachments to the ship from RSDAS ([pim@pml.ac.uk](mailto:pim@pml.ac.uk)) as available according to cloud conditions).

<i>Image type</i>		<i>Effective (end) date in 2005</i>	<i>Comments</i>
<i>SST composite</i>	<i>Frontal analysis</i>		
Y		22 August	Intense warm filament to NW from 60.1°N 4.4°W; cold, Faroes shelf to 60.3°N 5.7°W
	Y	26 August	Confirms SST composite features of 22 August
Y		2 September	Weak warm filament to N from 60.1°N 4.7°W; cold, Faroes shelf to 60.0 °N 5.6°W
	Y	4 September	Front along end of filament at 60.8°N and around cold feature.
Y		9 September	Cool ~30km diameter patch near 60.4°N 5°W; warm SW-NE aligned filament W of cool patch
	Y	9 September	Fronts weak except along NW side of filament
Y		13 September	3-day composite. Cool patch now near 60.5°N, 4.7°W, weaker. Warm over slope at 60.7°N 4°W (moved from 4.4°W) and (new) at 60.6°N 5.1°W.
Y		20 September	Warm patch near 60.3°N, 5.9°W, connected to shelf around cool patch at 60.0°N, 5.6°W. Isolated warm patch near 60.6°N, 4.8°W. All ~ 40km across.
Y		23 September	3-day composite. Cloudy in working area.

#### 5.10 Underway surface and meteorological measurements

(Christopher Smarz, IfM-GEOMAR, csmarz@ifm-geomar.de)

The underway surface measurements were collected by the PC-LOG computer in the dry lab.

It runs on software written by Dr.J.Rathlev at the Institute for Physics at Kiel, Germany:

Version 5.4, developed 1996. Collected data are:

<b>Underway Measurement Data</b>		
<i>Unit</i>	<i>Type</i>	<i>Data output</i>
<b>GG24</b>	GPS / GLONASS	Date, Time, Latitude, Longitude
<b>ADU2</b>	3-D GPS Ashtech	Heading, Roll, Pitch, COG, SOG
<b>LOG</b>	Sperry Marine	Speed
<b>Lot</b>	Elac LAZ4400 (cal.05)	Depth
<b>MeteoData</b>	DWD	Wind speed (S/P), Wind direction (S/P), Air temperature, Humidity, Water temperature, Air pressure
<b>Thermosal.</b>	ME CTD30 (cal.02.04)	Water temperature, Conductivity, Salinity, Sigma
<b>Gyro.Comp.</b>	Anschütz	Course

The data were stored every second in a binary day file, and converted to an ASCII file at the end of the cruise.

The meteorological data are sampled by a system from the Deutscher Wetter Dienst (DWD; German Weather Service). The data are also transmitted via satellite for weather forecast purposes. The system is renewed every year between docking.

The Thermosalinograph is made by ME Trappencamp / Germany. It is mounted in the bow in a tank which is continuously filled with water from outside in 2 metre depth, pump driven. The system ran for the whole cruise, recording from 0849 on 6 September to 0912 on 25 September.

#### 5.11 PES and bathymetry (Christopher Smarz, IfM-GEOMAR, csmarz@ifm-geomar.de, John Huthnance, POL, jmh@pol.ac.uk)

The Honeywell ELAC LAZ4400 is a precision fish-finding / navigation echo sounder. Output power and frequency is 600W at 150kHz. It comes with a high-performance transducer. The system was calibrated between docking in January 2005.

Available charts included (*inter alia*) Admiralty charts, GEBCO (digitized) contour plots, Roberts *et al.* (1977) and BP swath-bathymetry north-eastwards from the mooring area. The latter proved to be accurate and was of great assistance in placing the moorings in regular array at the desired depths. Admiralty charts were probably accurate but soundings were generally sparse relative to the spacing of stations on the cruise. The GEBCO and Roberts *et al.* (1977) charts differed from the Admiralty charts, BP swath-bathymetry and soundings obtained while deploying moorings and carrying out hydrographic sections on the cruise.

#### 5.12 Computing and other ship systems (John Huthnance, POL, [jmh@pol.ac.uk](mailto:jmh@pol.ac.uk))

Excellent computer support for the ship's systems was provided by the IfM-Geomar technician, Christopher Smarz. There was no general access to the internet but regular transmission of e-mails; satellite-image attachments were received (for example). The computers for the CTD, VMADCP and underway-recording were installed, but most other work was carried out on portable computers brought by the scientific party.

*F.S. Poseidon* proved a good ship for the purposes of this cruise, with well-positioned CTD, good deck space and handling facilities for mooring equipment, vessel-mounted ADCP and underway recording of meteorology and surface water temperature & salinity. Well-stabilised progress in passage was also appreciated. A couple of inherent limitations were considerable swell-induced roll on station when the stabilisers cannot operate, and high waves washing over the main deck; however, neither aspect was unusual for *F.S. Poseidon*'s size (1500 t). Cabin space for scientists and technicians is limited in comparison with recent expectations on multi-disciplinary cruises; however, it was fine for this purely physical oceanographic cruise.

Control of winches was difficult at times (as reported to IfM-Geomar), especially during mooring operations. The starboard winch to pass cable over the stern A frame started and stopped very suddenly, with little ability to run slowly. For deployments and recoveries over the port side, communication seemed to be difficult between the deck and operation of the relevant winch.

The ship's seamen and the IfM-Geomar CTD and computing support greatly helped the work of the scientific party. This was a large factor in being able to sustain initial intensive mooring deployments and subsequent 24-hour CTD operations. The UK participants were impressed with the crew's skill and hard work, helping the science and maintaining the ship to a high standard.

#### 5.13 References

- Hosegood, P., J. Bonnin and H. van Haren. 2004. Solibore-induced sediment resuspension in the Faeroe-Shetland Channel. *Geophysical Research Letters*, 31, L09301, doi:10.1029/2004GL019544.
- Hosegood, P. and H. van Haren. 2004. Near-bed solibores over the continental slope in the Faeroe-Shetland Channel. *Deep-Sea Research II*, 51, 2943-2971.
- Roberts, D.G., P.M. Hunter and A.S. Laughton (1977). *Bathymetry of the northeast Atlantic. Sheet 2: Continental margin around the British Isles, C6567*. Hydrographic Office, Taunton.

## 6. CONCLUSIONS

Good context and array data were obtained towards the overall scientific objectives. However, there were losses from the most novel measurements of microstructure for mixing estimates: HOMER microstructure (sensors and shear data lost during recovery) and NIOZ fast-sampling thermistor string (only 3 hours recorded).

The specific cruise objectives (1.1 to 1.11) were generally met. All exceptions were due to bad weather, causing the loss of nearly 10½ days out of 20. As it happened, stable 2005 summer conditions broke down to a run of depressions after a week of the cruise. For most of the lost time gales were forecast and significant wave heights ( $H_S$ ) exceeded 3m; conditions up to force 7 and/or  $H_S \sim 3$  m proved workable (depending on relative alignment).

The outcome of adverse weather was tempered by an initial generous allowance of cruise time on *F.S. Poseidon*, and the possibility of back-up recovery of moorings on closely following cruises. These are factors to bear in mind in future cruise planning.

For this particular study, there was almost certainly benefit in being able to adjust the mooring array location. It was centred on 600 m rather than 500 m water depth, as a result of the density profiles found just prior to the deployments. Following this choice, much internal wave activity was recorded. Hence there is an advantage to flexible array design. Positioning of the moorings was greatly helped by swath bathymetry from BP.

The repeat (24-hr) CTD+LADCP station (unfortunately only possible near neap tides) was found to provide excellent data for tidal current profiles and stratification. The repeat section across the slope would have benefited from covering water depths to 800m. As it was (200m to 700m; 13 hours curtailed by weather; near neap tides), bottom reflections prevented the vessel-mounted ADCP ranging through the thermocline.

Despite disappointments, the data show several interesting features. Distributions of temperature across and along the Faroe-Shetland Channel were unusual and varying. Tidal currents were strong below the main thermocline; rising bands of shear showed in repeat current profiles. Near-bed temperature and velocity showed sharp changes and packets of solitons of elevation propagating up-slope with ~ semi-diurnal frequency for four days.

Cruise planning greatly benefited from a visit by UKORS staff and the principal scientist to the ship support staff (and *F.S. Poseidon* itself) for the cruise planning meeting. This procedure is recommended for other barter cruises.

*F.S. Poseidon* proved generally a good ship for the purposes of this cruise.

Table 1 Moorings

<i>Mooring</i>	<i>Day (Sept.)</i>	<i>Time into water</i>	<i>Time at bottom</i>	<i>Latitude<sup>D</sup> N</i>	<i>Longitude<sup>D</sup> W</i>	<i>Depth m</i>	<i>Recovery Day</i>	<i>Time released</i>	<i>Time on deck</i>	<i>Latitude<sup>R</sup> N</i>	<i>Longitude<sup>R</sup> W</i>	<i>Comments</i>
SM01Cs	7	0805	0816	60° 13.78'	4° 39.16'	593	1 Oct	0700	0718	60° 13.93'	4° 38.69'	STABLE
SM02Ch	7	0920	0930	60° 13.65'	4° 39.61'	597	21	0922	0955	60° 13.87'	4° 38.86'	HOMER
SM03Cn	7	1159	1214	60° 13.52'	4° 40.06'	598	21	1049	1128/1140 <sup>N</sup>	60° 13.87'	4° 39.07'	NIOZ lander
SM04Wc	7	1330	1341	60° 12.81'	4° 42.01'	599	21	0752	0809	60° 12.97'	4° 41.67'	"West" 150kHz ADCP
SM05Wt	7	1415/1500*	---	60° 12.90'	4° 41.84'	601	21	0821	0841	60° 12.94'	4° 41.65'	"West" Mini-loggers
SM06Nc	7	1703	---	60° 15.01'	4° 41.31'	653	30	1745	1802	60° 15.11'	4° 41.18'	"North" 75kHz ADCP
SM07Ec	8	0724	---	60° 14.49'	4° 37.22'	597	21	0626	0644	60° 14.50'	4° 37.15'	"East" 600kHz ADCP
SM08Et	8	0827	---	60° 14.41'	4° 37.46'	597	21	0648	0701	60° 14.44'	4° 37.22'	"East" Mini-loggers
SM09Sc	8	0946	0956	60° 12.70'	4° 38.59'	553	21	1214	1230	60° 12.80'	4° 38.16'	"South" 150kHz ADCP
SM10St	8	1034	---	60° 12.80'	4° 38.45'	556	21	1238	1256	60° 12.83'	4° 38.17'	"South" Mini-loggers

All times GMT, days refer to September unless otherwise stated.

D: Positions at time of deployment (release from the ship)

R: Positions at time of recovery (grappled alongside the ship). The deployment positions should be regarded as definitive.

N: times on deck of thermistor chain and lander respectively.

\*Times before / after going about.



Table 2. CTD/LADCP stations. Sections across the West Shetland slope and Faroe-Shetland Channel are formed by casts 13-37: central; 38-57: western; 83-99: eastern. Casts 100-105: incomplete along-slope section at 700 m water depth. Casts 58-82: 24-hour repeat station.

<i>Poseidon Event</i>	<i>Cast</i>	<i>Day (Sept.)</i>	<i>Time into water</i>	<i>Time at surface</i>	<i>Latitude N</i>	<i>Longitude W</i>	<i>Depth m</i>	<i>Bottles m</i>	<i>Comments</i>
563	001	6	1920	2000	60° 20.08'	4° 50.71'	911	4ab, 9	No LADCP
565	002	7	0600	0628	60° 12.24'	4° 35.47'	508	4ab, 10	LADCP
566	003	7	0719	0744	60° 13.82'	4° 39.03'	593	5ab,10	
568	004	7	0838	0904	60° 13.45'	4° 39.69'	599	5ab	
569	005	7	1003	1029	60° 13.63'	4° 39.90'	600	5ab, 9	
570	006	7	1248	1315	60° 12.88'	4° 42.03'	603	5ab,10	
572	007	7	1547	1616	60° 15.11'	4° 41.42'	658	9	
574	008	7	1830	1900	60° 10.70'	4° 33.14'	420	10	
575	009	7	1953	2010	60° 08.89'	4° 30.24'	316	3ab	
576	010	7	2047	2103	60° 06.97'	4° 28.19'	195	3ab,10	
578	011	8	0620	0650	60° 14.53'	4° 38.50'	605	3ab	
581	012	8	0904	0929	60° 12.73'	4° 37.17'	553	3ab, 8	
584	013	8	1212	1227	60° 06.99'	4° 27.99'	204	3ab, 11	bottles only
585	014	8	1319	1335	60° 08.63'	4° 30.64'	293		per 4 hours
586	015	8	1412	1433	60° 10.32'	4° 33.29'	409		hereafter
587	016	8	1710	1738	60° 12.02'	4° 35.41'	503	4ab, 11	
588	017	8	1825	1852	60° 13.94'	4° 39.16'	606		Short LADCP
589	018	8	1939	2009	60° 15.63'	4° 42.42'	682	4ab,10	
590	019	8	2044	2119	60° 17.57'	4° 45.55'	796	4ab	
591	020	8	2204	2241	60° 20.09'	4° 49.80'	905		
592	021	8	2340	2423	60° 21.98'	4° 53.40'	963	4ab, 11	
593	022	9	0107	0147	60° 23.90'	4° 56.82'	985		
594	023	9	0232	0310	60° 25.90'	5° 00.21'	957		
595	024	9	0426	0513	60° 27.89'	5° 03.70'	983		bottle misfire?
596	025	9	0602	0650	60° 29.82'	5° 06.94'	976		
597	026	9	0731	0819	60° 31.84'	5° 09.81'	942		
598	027	9	0902	0942	60° 34.07'	5° 13.42'	874		
599	028	9	1026	1104	60° 36.19'	5° 16.77'	836		
600	029	9	1148	1226	60° 38.04'	5° 19.84'	792		
601	030	9	1317	1350	60° 39.90'	5° 24.06'	754	4ab, 13	Short LADCP
602	031	9	1432	1504	60° 41.86'	5° 27.69'	734		
603	032	9	1558	1626	60° 43.90'	5° 31.53'	694		
604	033	9	1706	1735	60° 45.72'	5° 34.99'	676	4ab,10	
605	034	9	1833	1858	60° 47.89'	5° 37.85'	604		
606	035	9	1939	2002	60° 49.88'	5° 41.08'	473		
607	036	9	2048	2113	60° 52.08'	5° 44.30'	382		
608	037	9	2151	2209	60° 53.89'	5° 47.75'	339	3ab,10	
609	038	10	0121	0146	60° 30.20'	5° 59.62'	472	4ab, 12	
610	039	10	0237	0302	60° 27.56'	5° 58.19'	477		
611	040	10	0351	0415	60° 25.45'	5° 55.42'	509		
612	041	10	0458	0524	60° 23.34'	5° 53.61'	560	5ab, 10	
613	042	10	0606	0635	60° 21.51'	5° 52.01'	591		
614	043	10	0710	0739	60° 20.03'	5° 49.98'	636		
615	044	10	0815	0848	60° 18.36'	5° 48.32'	692		
616	045	10	0923	0958	60° 16.58'	5° 46.43'	805		
617	046	10	1033	1113	60° 14.87'	5° 44.73'	957		
618	047	10	1155	1241	60° 13.17'	5° 43.14'	1178	999, 12	1000m max for LADCP
619	048	10	1338	1421	60° 10.32'	5° 40.30'	1103		1000m max for LADCP
620	049	10	1514	1556	60° 07.72'	5° 37.86'	1015	1000,10	
621	050	10	1647	1722	60° 05.36'	5° 35.39'	961		

622	051	10	1828	1903	60° 03.08'	5° 33.80'	907		
623	052	10	1938	2014	60° 01.01'	5° 31.10'	832		ΔT,S@600m
624	053	10	2054	2128	59° 58.96'	5° 28.96'	745		
625	054	10	2207	2239	59° 56.72'	5° 26.76'	642		
626	055	10	2333	2357	59° 54.42'	5° 24.36'	531	5ab, 11	
627	056	11	0041	0101	59° 52.21'	5° 22.19'	406		
628	057	11	0149	0206	59° 49.99'	5° 19.99'	295		
629	058	11	0546	0619	60° 15.79'	4° 42.62'	689	4ab, 10	Start 24-hr
630	059	11	0704	0732	60° 15.65'	4° 42.40'	684		
631	060	11	0806	0834	60° 15.66'	4° 42.42'	684		no LADCP
632	061	11	0908	0940	60° 15.66'	4° 42.42'	686		
633	062	11	1003	1031	60° 15.66'	4° 42.38'	696		
634	063	11	1107	1138	60° 15.64'	4° 42.38'	684	4ab, 12	
635	064	11	1207	1236	60° 15.67'	4° 42.41'	687		
636	065	11	1304	1333	60° 15.65'	4° 42.42'	683		
637	066	11	1403	1432	60° 15.65'	4° 42.37'	686		
638	067	11	1504	1532	60° 15.65'	4° 42.37'	685	4ab, 10	
639	068	11	1602	1630	60° 15.63'	4° 42.39'	684		
640	069	11	1707	1734	60° 15.64'	4° 42.40'	684		
641	070	11	1803	1831	60° 15.65'	4° 42.40'	697		
642	071	11	1906	1935	60° 15.63'	4° 42.42'	683		
643	072	11	2009	2034	60° 15.65'	4° 42.40'	683		On bottom
644	073	11	2108	2140	60° 15.63'	4° 42.41'	682	3ab, 10	
645	074	11	2204	2232	60° 15.68'	4° 42.42'	687		
646	075	11	2304	2332	60° 15.63'	4° 42.40'	684	4ab, 12	
647	076	12	0004	0032	60° 15.65'	4° 42.38'	684		
648	077	12	0106	0133	60° 15.65'	4° 42.42'	686		
649	078	12	0204	0231	60° 15.66'	4° 42.39'	686		
650	079	12	0304	0333	60° 15.66'	4° 42.47'	698	4ab, 10	
651	080	12	0402	0431	60° 15.66'	4° 42.40'	684		
652	081	12	0501	0534	60° 15.67'	4° 42.52'	687		
653	082	12	0606	0634	60° 15.66'	4° 42.44'	686		End 24-hr
654	083	15	2030	2047	60° 32.08'	2° 59.82'	202	3ab, 10	Begin East
655	084	15	2125	2144	60° 34.56'	3° 02.77'	222	~10ab,9	
656	085	15	2220	2236	60° 37.03'	3° 05.88'	291		
657	086	15	2318	2336	60° 39.53'	3° 08.78'	388		
659	087	16	0016	0038	60° 41.96'	3° 12.05'	451		
660	088	16	0117	0140	60° 44.50'	3° 15.01'	517		
661	089	16	0222	0248	60° 47.00'	3° 18.01'	580		
662	090	16	0347	0414	60° 49.57'	3° 20.58'	653		
663	091	16	0505	0540	60° 51.92'	3° 24.04'	750		
664	092	16	0624	0700	60° 54.50'	3° 27.16'	899		
665	093	16	0738	08??	60° 56.88'	3° 29.96'	1038		
666	094	16	0857	0938	60° 59.51'	3° 32.90'	1114		No LADCP
667	095	16	1024	1104	60° 59.49'	3° 40.20'	1123	3ab, 12	No LADCP
668	096	16	1149	1236	60° 59.44'	3° 48.02'	1117		No LADCP
669	097	16	1319	1404	60° 59.44'	3° 56.12'	1137		No LADCP
670	098	16	1451	1534	60° 59.52'	4° 04.05'	1145	3ab, 10	No LADCP
671	099	16	1627	1710	60° 59.88'	4° 12.42'	1152	3ab	No LADCP
672	100	16	2013	2044	60° 52.47'	3° 19.18'	710	3ab, 10	LADCP
673	101	16	2143	2215	60° 50.41'	3° 24.75'	713		LADCP
674	102	16	2312	2343	60° 48.15'	3° 30.06'	718	699, 11	henceforth
675	103	17	0039	0111	60° 46.48'	3° 35.27'	703		
676	104	17	0211	0248	60° 44.77'	3° 39.75'	710		
677	105	17	0354	0426	60° 43.33'	3° 45.19'	710	699, 9	

Figure 1. Track plot, Torshavn (62N, 6.9W; 06/09/05) to Aberdeen (57.1N, 2W; 25/09/05)  
Figures 2 and 3 show the areas of scientific work.

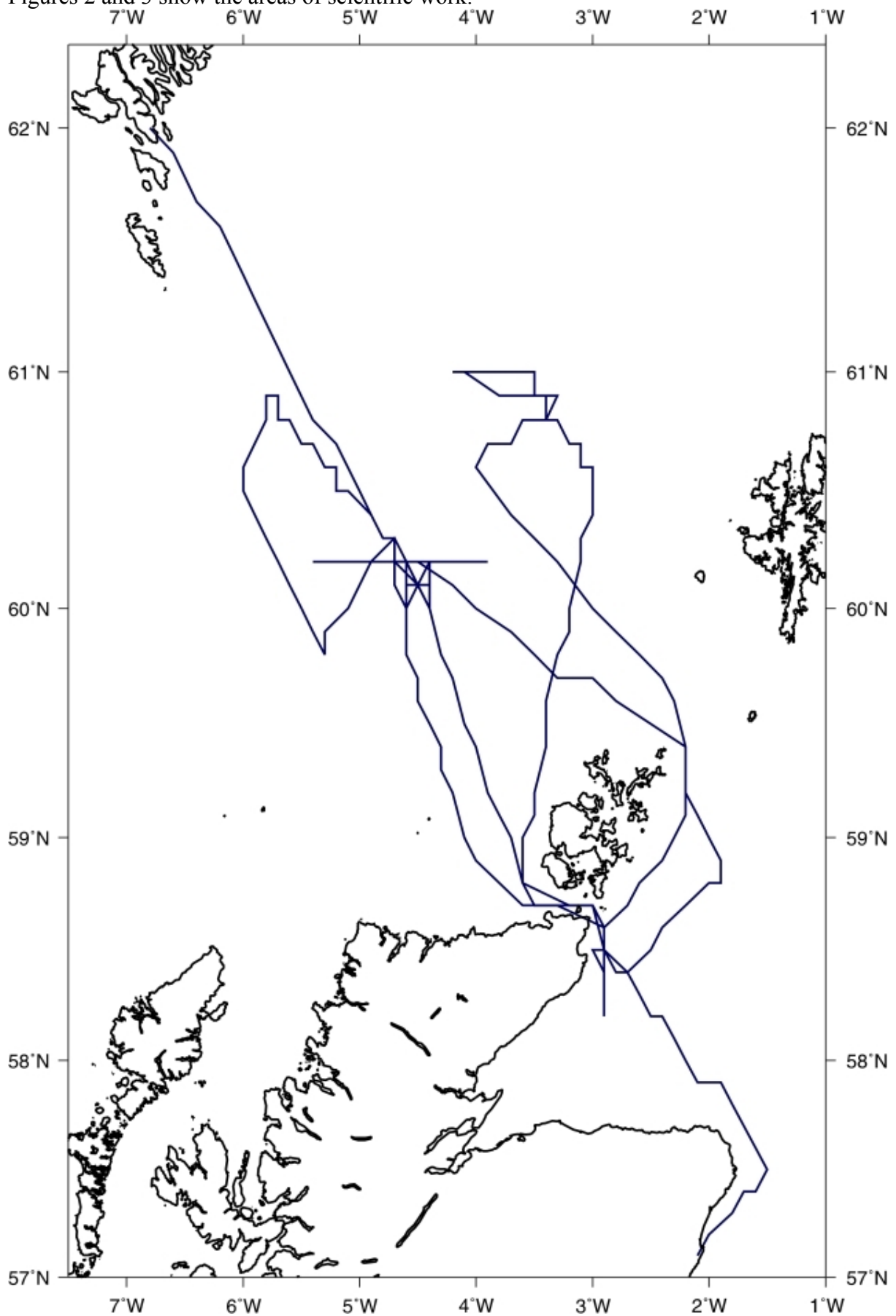

Figure 2. Mooring locations.

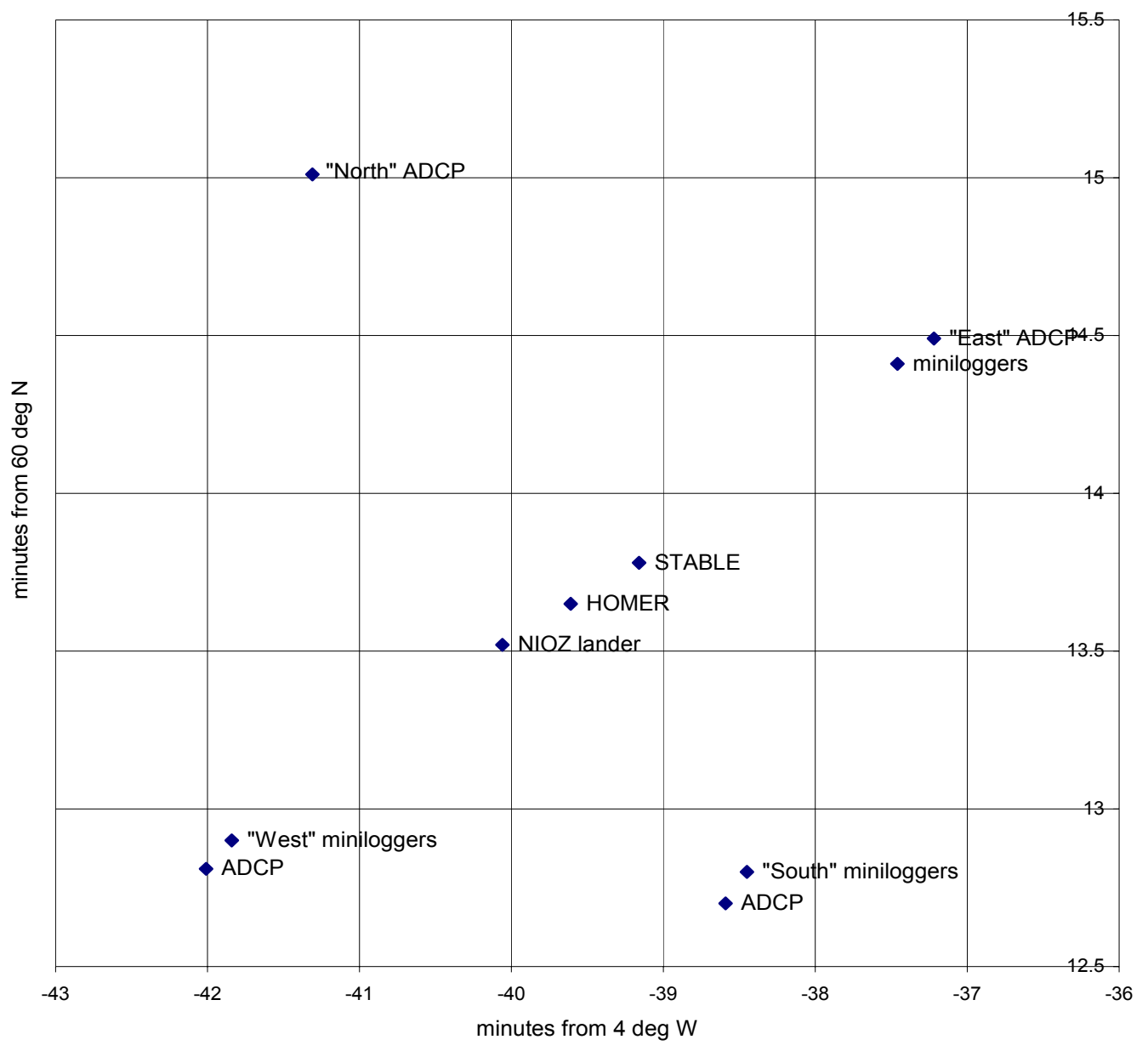

Figure 3. CTD locations. Sections across the West Shetland slope and Faroe-Shetland Channel are formed by casts 13-37: central; 38-57: western; 83-99: eastern. Casts 100-105: incomplete along-slope section at 700 m water depth. Casts 58-82: 24-hour repeat station.

